



**THE DATASHEET OF
ABM2-40.000MHZ-D4YF-T**



CERAMIC SMD MICROPROCESSOR CRYSTAL

ABM2

RoHS/RoHS II Compliant

RoHS/RoHS II compliant. Pb in glass (exempt 7(c) per 2015/863/EU Annex)



Typical 8.0 x 4.5 x 1.6mm

Moisture Sensitivity Level (MSL) –This product is Hermetically Sealed and not Moisture Sensitive -MSL = N/A: Not Applicable

FEATURES:

- Low in height; suitable for thin equipment
- Glass sealed package assures high reliability and high temperature operation
- Tight tolerance and stability available
- Suitable for RoHS compliant reflow
- Low cost glass sealed crystal solution

APPLICATIONS:

- High density applications
- Modems, communication and test equipment
- PCMCIA, Wireless applications
- Microprocessor crystals

STANDARD SPECIFICATIONS:

Parameters	Minimum	Typical	Maximum	Units	Notes
FrequencyRange	8.000	-----	100.000	MHz	Fundamental
Operation mode	8.000	-----	40.000		Fundamental AT-cut (Standard)
	40.001	-----	100.000		3 rd OT AT -cut (Standard)
	40.001	-----	60.000		Fundamental AT-cut (See options)
Operating Temperature	-10	-----	+60	°C	See options
Storage Temperature	-40	-----	+85	°C	
Frequency Tolerance@ +25°C	-50	-----	+50	ppm	See options
Frequency Stability over the Operating Temperature (ref. to +25°C)	-50	-----	+50	ppm	See options
Equivalent series resistance	-----	-----	100	Ω	8.000 – 10.000MHz (Fundamental)
	-----	-----	60		10.001 – 15.999MHz (Fundamental)
	-----	-----	50		16.000 – 60.000MHz (Fundamental)
	-----	-----	70		40.000 – 100.000MHz (3 rd OT)
Shunt capacitance (C0)	-----	-----	7	pF	-----
Load capacitance (CL)	-----	18	-----	pF	See options
Drive Level	-----	10	100	μW	
Aging @ 25°C±3°C	-----	-----	±5	ppm	First year
Insulation Resistance	500	-----	-----	MΩ	@ 100Vdc

CERAMIC SMD MICROPROCESSOR CRYSTAL

ABM2

RoHS/RoHS II Compliant

RoHS/RoHS II compliant. Pb in glass (exempt 7(c) per 2015/863/EU Annex)



Typical 8.0 x 4.5 x 1.6mm

OPTIONS AND PART IDENTIFICATION: (Left blank if standard)

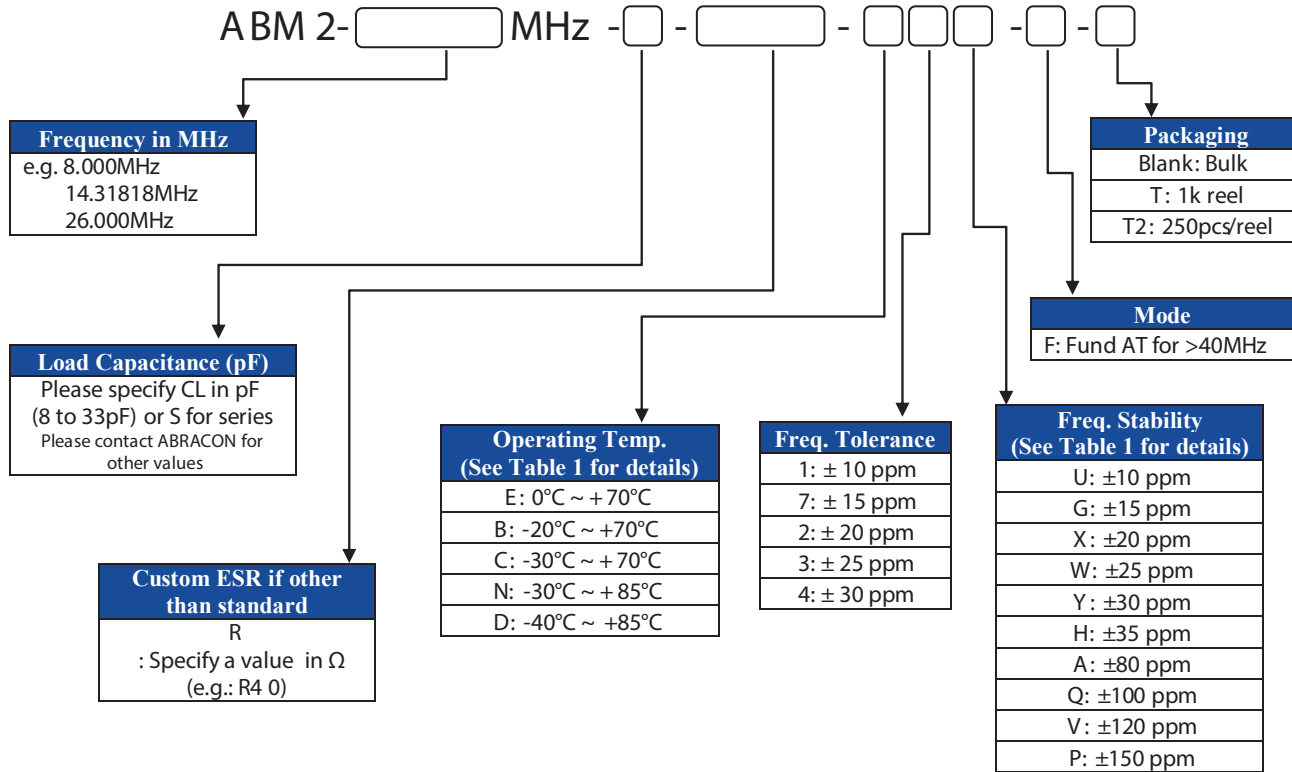

Note: See Table 1 for the availability of Operating Temp. and Freq. Stability combination

Table 1 Available Combinations of Operating Temp. and Freq. Stability

Operating Temp.	Freq. Stability					
	U:±10ppm	G:±15ppm	X:±20ppm	W:±25ppm	Y:±30ppm	H:±35ppm
Std: -10°C ~ +60°C	√	√	√	√	√	√
E: 0°C ~ +70°C		√	√	√	√	√
B: -20°C ~ +70°C		√	√	√	√	√
C: -30°C ~ +70°C				√	√	√
N: -30°C ~ +85°C					√	√
D: -40°C ~ +85°C					√*	√*

Operating Temp.	Freq. Stability				
	Std:±50ppm	A:±80ppm	Q:±100ppm	V:±120ppm	P:±150ppm
Std: -10°C ~ +60°C	√	√	√	√	√
E: 0°C ~ +70°C	√	√	√	√	√
B: -20°C ~ +70°C	√	√	√	√	√
C: -30°C ~ +70°C	√	√	√	√	√
N: -30°C ~ +85°C	√	√	√	√	√
D: -40°C ~ +85°C	√*	√	√	√	√

Note: *: Availability depends on frequency.

CERAMIC SMD MICROPROCESSOR CRYSTAL

ABM2

RoHS/RoHS II Compliant

RoHS/RoHS II compliant. Pb in glass (exempt 7(c) per 2015/863/EU Annex)



Typical 8.0 x 4.5 x 1.6mm

OUTLINE DIMENSION:

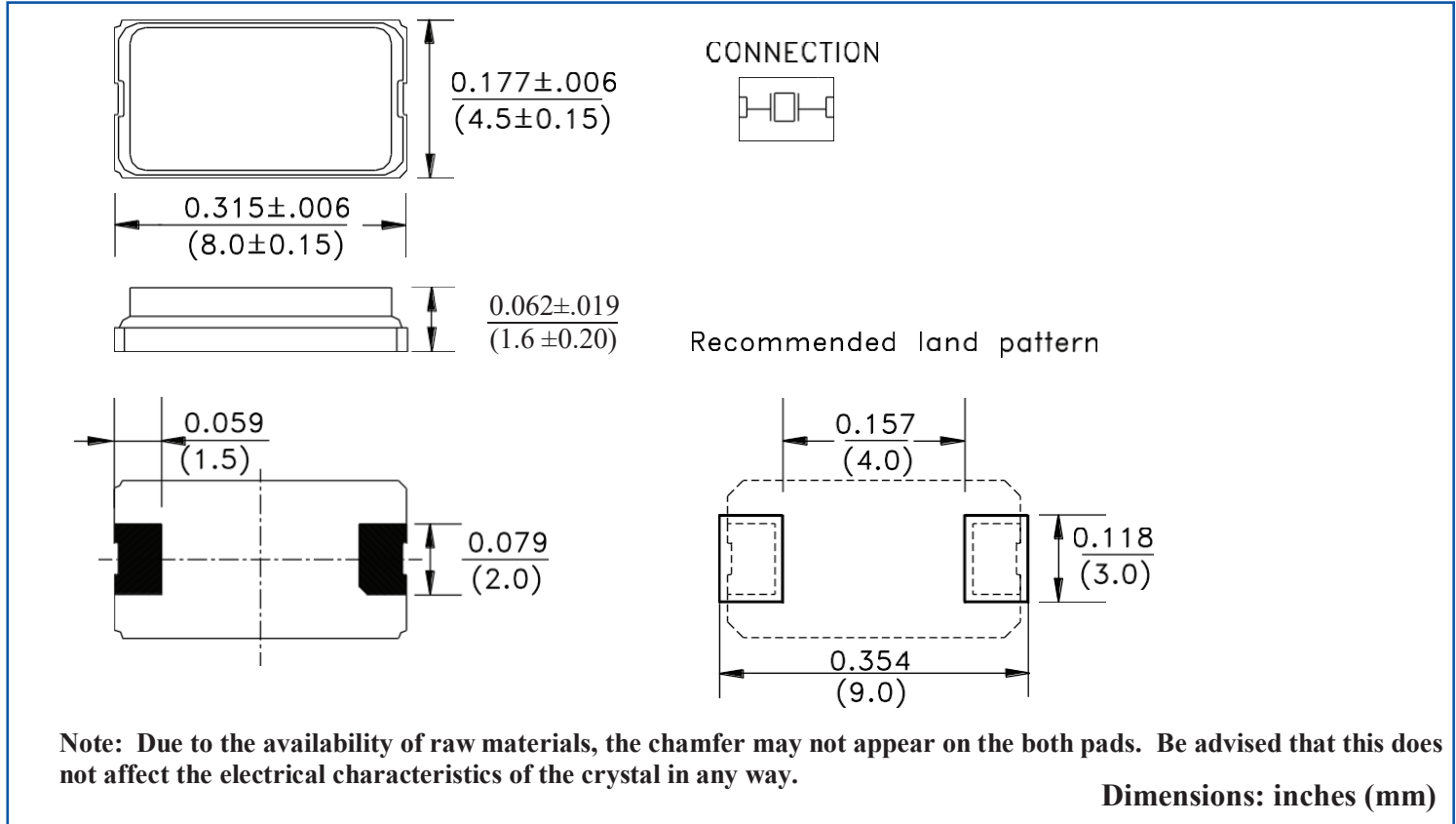

REFLOW PROFILE:

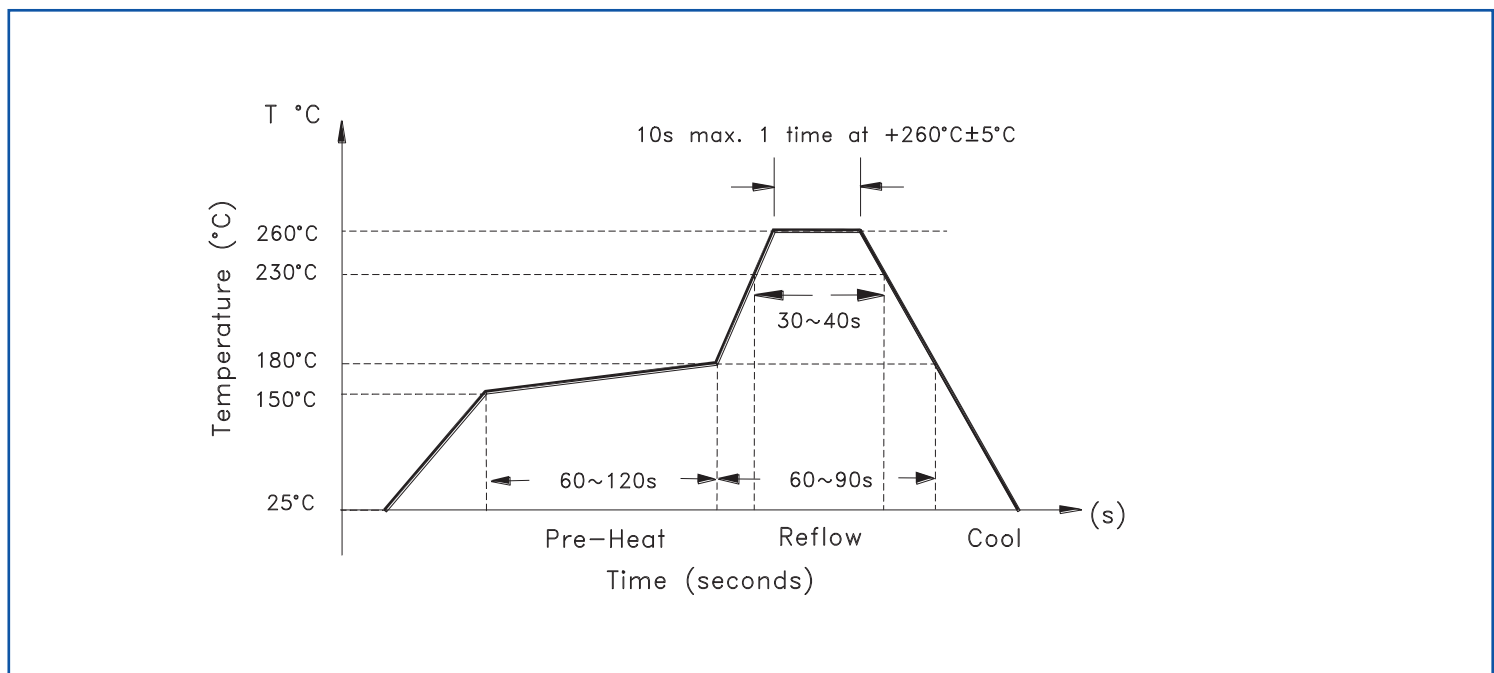

CERAMIC SMD MICROPROCESSOR CRYSTAL

ABM2

RoHS/RoHS II Compliant

RoHS/RoHS II compliant. Pb in glass (exempt 7(c) per 2015/863/EU Annex)



Typical 8.0 x 4.5 x 1.6mm

TAPE & REEL:

T: 1000pcs/reel

T2: 250pcs/reel

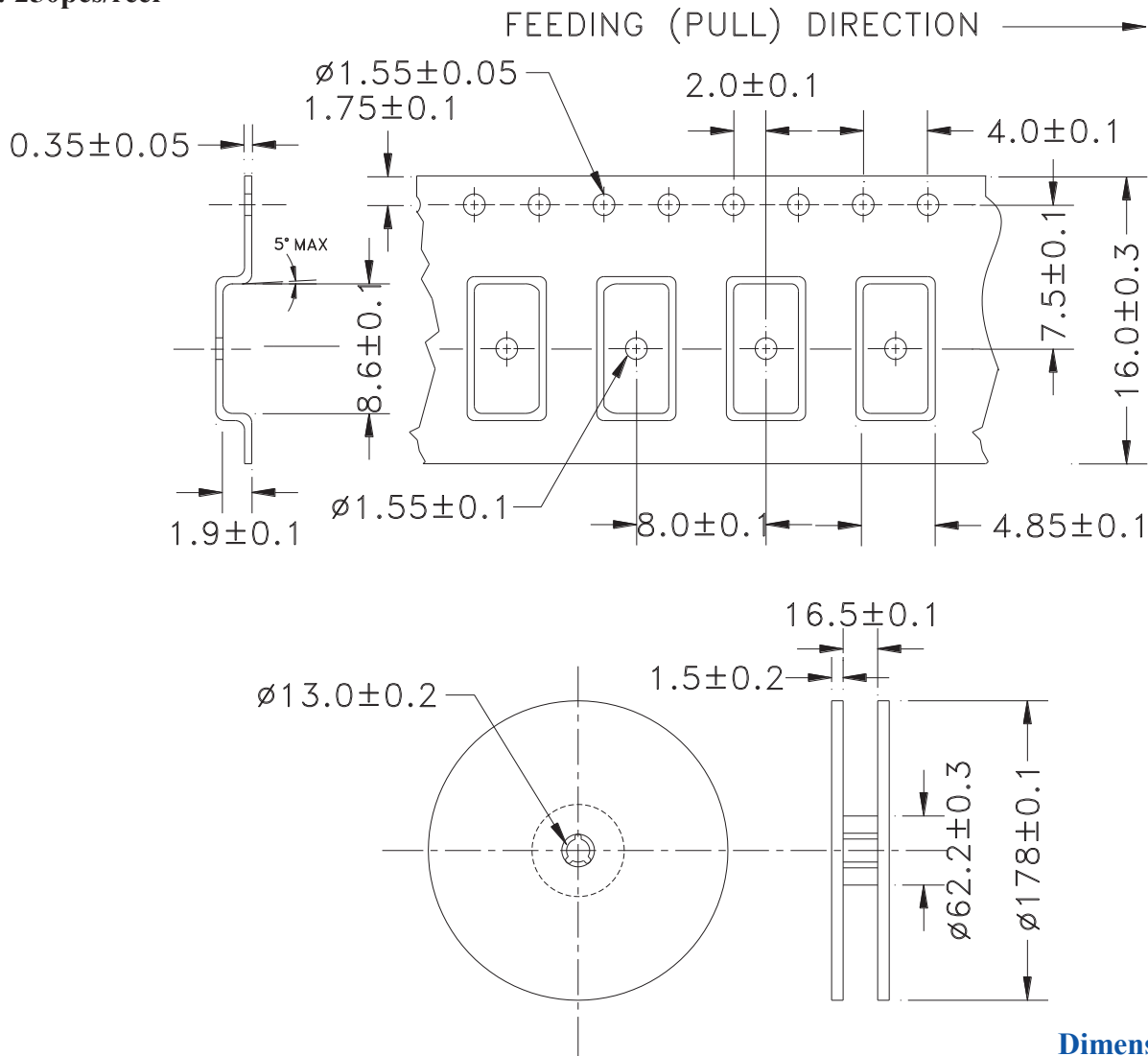

ATTENTION: Abracon LLC's products are COTS – Commercial-Off-The-Shelf products; suitable for Commercial, Industrial and, where designated, Automotive Applications. Abracon's products are not specifically designed for Military, Aviation, Aerospace, Life-dependent Medical applications or any application requiring high reliability where component failure could result in loss of life and/or property. For applications requiring high reliability and/or presenting an extreme operating environment, written consent and authorization from Abracon LLC is required. Please contact Abracon LLC for more information.

Looking for pricing, stock, or lifecycle information?

Click below to explore more details on WIN SOURCE:

- ⊖ [View ABM2-40.000MHZ-D4YF-T on WIN SOURCE](#)
- ⊖ [Abracon LLC Information](#)

Optimize Your Supply Chain with WIN SOURCE Solutions

- ✓ Global Sourcing Solution
- ✓ Obsolete Management
- ✓ Cost Control Management
- ✓ Shortage Management
- ✓ Alternative Solution
- ✓ Excess Inventory Management