



**THE DATASHEET OF
DS1233AZ-10/TR/C16**



FEATURES

- Automatically restarts microprocessor after power failure
- Monitors pushbutton for external override
- Internal circuitry debounces pushbutton switch
- Maintains reset for 350ms after V_{CC} returns to an in-tolerance condition or pushbutton released
- Accurate 10% or 15% microprocessor 3.3V power supply monitoring
- Reduces need for discrete components
- Precision temperature-compensated voltage reference and voltage sensor
- Low-cost TO-92 package or surface mount SOT-223 package
- Internal 5k Ω pull-up resistor
- Operating temperature of -40°C to +85°C

PIN ASSIGNMENT

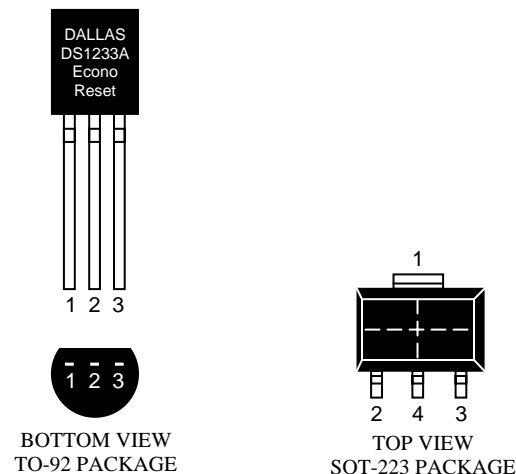

PIN DESCRIPTION

PIN 1	$\overline{\text{GROUND}}$
PIN 2	$\overline{\text{RESET}}$
PIN 3	V_{CC}
PIN 4	$\overline{\text{GROUND}}$ (SOT-223 ONLY)

DESCRIPTION

The DS1233A EconoReset monitors two vital conditions for a microprocessor: power supply and external override. A precision temperature-compensated reference and comparator circuit are used to monitor the status of the power supply (V_{CC}). When an out-of-tolerance condition is detected, an internal power fail signal is generated which forces reset to the active state. When V_{CC} returns to an in-tolerance condition, the reset signal is kept in the active state for approximately 350ms to allow the power supply and processor to stabilize. The second function of the DS1233A is pushbutton reset control. The DS1233A debounces a pushbutton closure and will generate a 350ms reset pulse upon release.

OPERATION — POWER MONITOR

The DS1233A provides the functions of detecting out-of-tolerance power supply conditions and warning a processor-based system of impending power failure. When V_{CC} is detected as out-of-tolerance as defined by the tolerance of the part selected, the $\overline{\text{RST}}$ signal is asserted. On power-up, $\overline{\text{RST}}$ is kept active for approximately 350ms after the power supply has reached the selected tolerance. This allows the power supply and microprocessor to stabilize before $\overline{\text{RST}}$ is released.

OPERATION — PUSHBUTTON RESET

The DS1233A provides for a pushbutton switch to be connected to the $\overline{\text{RST}}$ output pin. When the DS1233A is not in a reset cycle, it continuously monitors the $\overline{\text{RST}}$ signal for a low-going edge. If an edge is detected, the DS1233A will debounce the switch by pulling the $\overline{\text{RST}}$ line low. After the internal timer has expired, the DS1233A will continue to monitor the $\overline{\text{RST}}$ line. If the line is still low, the DS1233A will continue to monitor the line looking for a rising edge. Upon detecting a release, the DS1233A will force the $\overline{\text{RST}}$ line low and hold it low for 350ms.

NOTE:

For proper operation with an external pushbutton, a capacitor between 100pF and 0.01 μ F must be connected between $\overline{\text{RST}}$ and ground. In applications where additional reset current is required, a minimum capacitance of 500 pF should be used, along with a parallel external pull-up resistor of 1k Ω minimum.

BLOCK DIAGRAM Figure 1

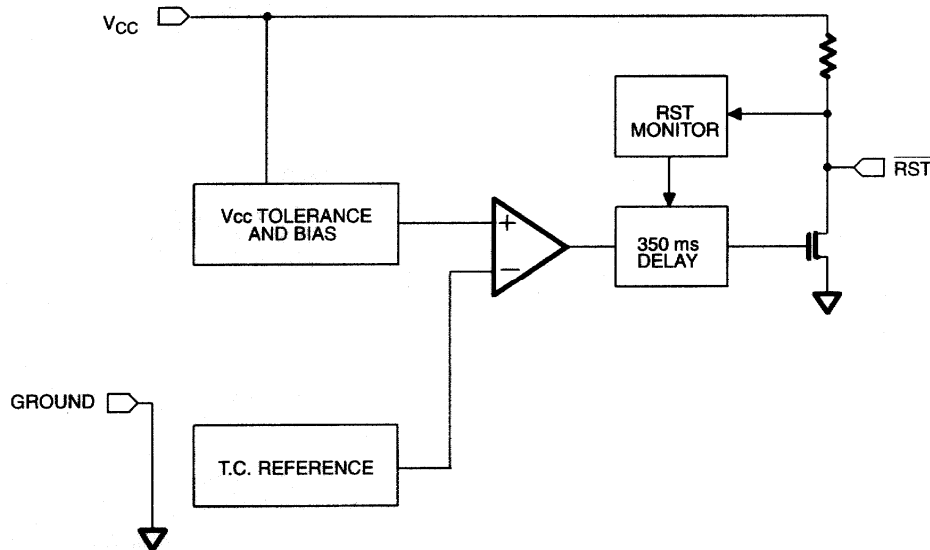

APPLICATION EXAMPLE Figure 2

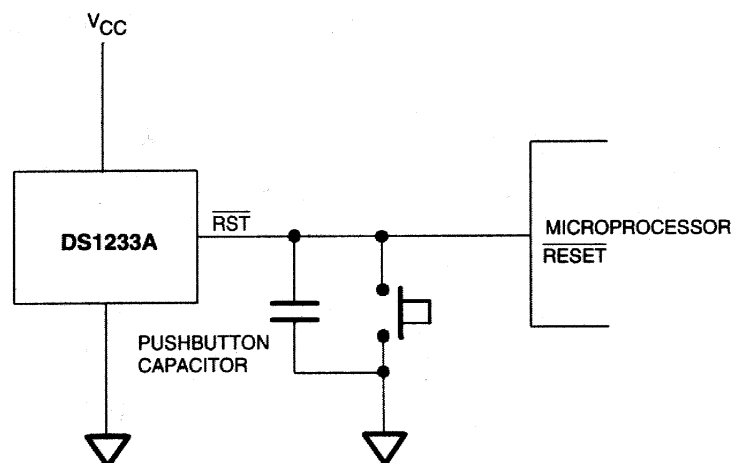

PUSHBUTTON RESET Figure 3

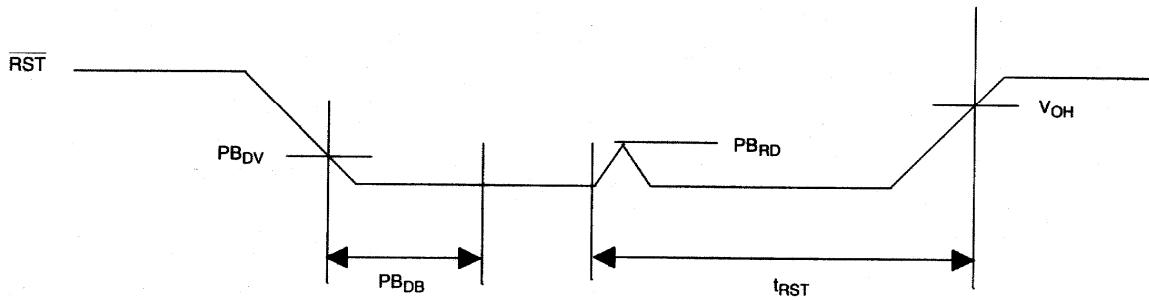

POWER-UP Figure 4

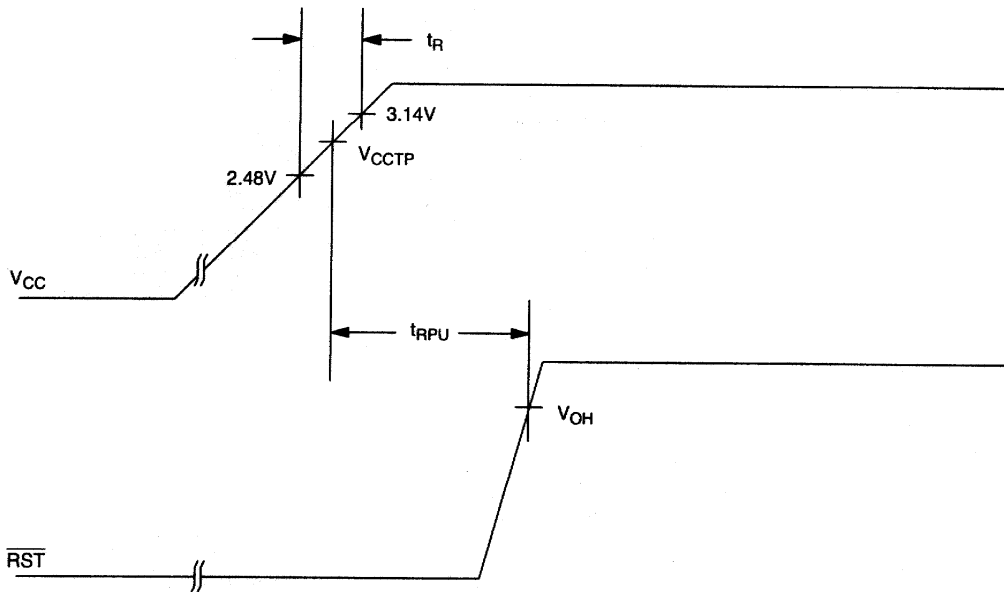

POWER-DOWN Figure 5

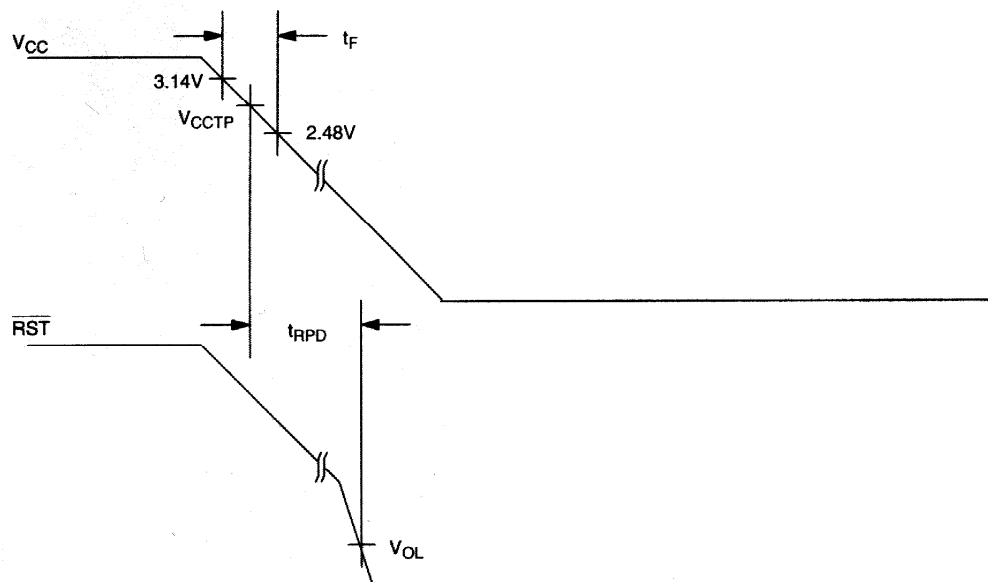

ABSOLUTE MAXIMUM RATINGS*

Voltage on V _{CC} Pin Relative to Ground	-0.5V to +7.0V
Voltage on I/O Relative to Ground	-0.5V to V _{CC} +0.5V
Operating Temperature Range	-40°C to +85°C
Storage Temperature Range	-55°C to +125°C
Soldering Temperature	260°C for 10 seconds

* This is a stress rating only and functional operation of the device at these or any other conditions above those indicated in the operation sections of this specification is not implied. Exposure to absolute maximum rating conditions for extended periods of time may affect reliability.

RECOMMENDED DC OPERATING CONDITIONS (-40°C to +85°C)

PARAMETER	SYMBOL	MIN	TYP	MAX	UNITS	NOTES
Supply Voltage	V _{CC}	1.2	3.3	5.5	V	1

DC ELECTRICAL CHARACTERISTICS (-40°C to +85°C; V_{DD} = 3.3V ± 10%)

PARAMETER	SYMBOL	MIN	TYP	MAX	UNITS	NOTES
Low Level @ $\overline{\text{RST}}$	V _{OL}			0.4	V	1
Output Current @ 0.4V	I _{OL}	+8			mA	
Operating Current	I _{CC}			50	μA	
V _{CC} Trip Point 10%	V _{CC} TP1	2.80	2.88	2.97	V	1
V _{CC} Trip Point 15%	V _{CC} TP2	2.64	2.72	2.80	V	1
Output Capacitance	C _{OUT}			10	pF	
Pushbutton Detect	PB _{DV}	0.8		2.0	V	1
Pushbutton Release	PB _{RD}		0.3	0.8	V	1, 2
Internal Pull-Up Resistor	R _P	3.75	5	6.25	kΩ	

AC ELECTRICAL CHARACTERISTICS (-40°C to +85°C; V_{CC} = 3.3V ± 10%)

PARAMETER	SYMBOL	MIN	TYP	MAX	UNITS	NOTES
Reset Active Time	t _{RST}	250	350	450	ms	
V _{CC} Detect to $\overline{\text{RST}}$	t _{RPD}			100	ns	
V _{CC} Slew Rate (2.85V - 2.3V)	t _F	300			μs	
V _{CC} Slew Rate (2.3V - 2.85V)	t _R	0			ns	
Pushbutton Debounce	PB _{DB}	250	350	450	ms	
V _{CC} Detect to RST	t _{RPU}	250	350	450	ms	

NOTES:

- 1) All voltages are referenced to ground.
- 2) With a 100pF to 0.01μF capacitor connected from $\overline{\text{RST}}$ to ground.

ECONORESET SELECTION GUIDE

		V_{CC} TRIP POINT			PUSHBUTTON DETECT		
		MIN	TYP	MAX	MIN	TYP	MAX
5V	DS1233-15	4.0	4.125	4.24	1.8	-	3.3
	DS1233-10	4.25	4.375	4.49	1.8	-	3.3
	DS1233-5	4.5	4.625	4.75	1.8	-	3.3
	DS1233D-15	4.0	4.125	4.24	N/A		N/A
	DS1233D-10	4.25	4.375	4.49	N/A		N/A
	DS1233D-5	4.5	4.625	4.75	N/A		N/A
	DS1833-15	4.0	4.125	4.24	N/A		N/A
	DS1833-10	4.25	4.375	4.49	N/A		N/A
	DS1833-5	4.5	4.625	4.75	N/A		N/A
3.3V	DS1233A-15	2.64	2.72	2.80	0.8	-	2.0
	DS1233A-10	2.8	2.88	2.97	0.8	-	2.0



PACKAGE INFORMATION

For the latest package outline information and land patterns, go to www.maxim-ic.com/packages.

PACKAGE TYPE	PACKAGE CODE	DOCUMENT NO.
TO 92	Q3+1	21-0248
TO 92	Q3+4	21-0250
SOT 223	K3+1	21-0264

Looking for pricing, stock, or lifecycle information?

Click below to explore more details on WIN SOURCE:

-  [View DS1233AZ-10/TR/C16 on WIN SOURCE](#)
-  [Maxim Integrated Information](#)

Optimize Your Supply Chain with WIN SOURCE Solutions

-  Global Sourcing Solution
-  Obsolete Management
-  Cost Control Management
-  Shortage Management
-  Alternative Solution
-  Excess Inventory Management