

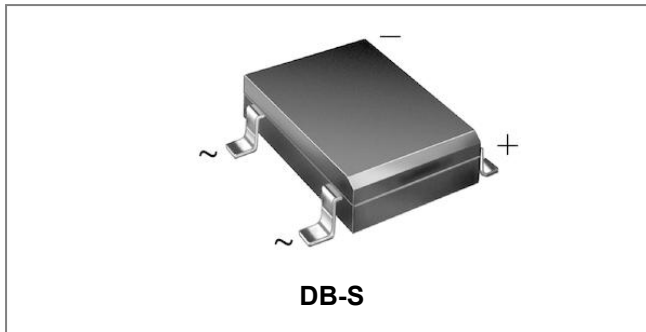

THE DATASHEET OF DB153S



DB151S THRU DB157S SINGLE-PHASE GLASS PASSIVATED SILICON BRIDGE RECTIFIERS



Features

- Glass passivated die construction
- Low forward voltage drop
- High current capability
- High surge current capability
- Designed for surface mount application
- Plastic material-UL flammability 94V-0
- This is a Pb – Free Device
- All SMC parts are traceable to the wafer lot
- Additional testing can be offered upon request

Circuit Diagram

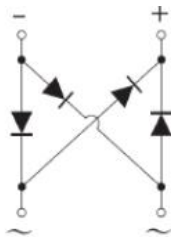

Mechanical Data

- Case: DB-S, molded plastic
- Terminals: plated leads solderable per MIL-STD-202, Method 208
- Polarity: as marked on case
- Mounting position: Any
- Lead Free: For RoHS / Lead Free Version,

Maximum Ratings @ $T_A=25^{\circ}\text{C}$ unless otherwise specified

Single Phase half wave 60Hz, resistive or inductive load. For capacitive load current derate by 20%.

Characteristic	Symbol	DB 151S	DB 152S	DB 153S	DB 154S	DB 155S	DB 156S	DB 157S	Units
Peak Repetitive Reverse Voltage Working Peak Reverse Voltage DC Blocking Voltage	V_{RRM} V_{RWM} V_R	50	100	200	400	600	800	1000	V
RMS Reverse Voltage	V_{RMS}	35	70	140	280	420	560	700	V
Average Forward Output Current (Note 1) @ $T_C = 100^{\circ}\text{C}$	$I_{F(AV)}$	1.5							A
Non-Repetitive Peak Forward Surge Current 8.3ms Single half sine-wave superimposed on rated load (JEDEC Method)	I_{FSM}	55							A
I^2t Rating for Fusing ($t < 8.3\text{ms}$)	I^2t	12.6							A^2s

Electrical Characteristics @ $T_A=25^{\circ}\text{C}$ unless otherwise specified

Characteristic	Symbol	DB 151S	DB 152S	DB 153S	DB 154S	DB 155S	DB 156S	DB 157S	Units
Maximum Forward Voltage Drop* per Bridge Element @ $I_F=1.5\text{A}$, $T_J=25^{\circ}\text{C}$	V_F	1.0							V
Peak Reverse Current* At Rated DC Blocking Voltage* @ $T_A=25^{\circ}\text{C}$ @ $T_A=125^{\circ}\text{C}$	I_R	5 100							μA
Typical Junction Capacitance (Note 2)	C_J	20							pF

* Pulse width < 300 μs , duty cycle < 2%

Thermal-Mechanical Specifications @ $T_A=25^{\circ}\text{C}$ unless otherwise specified

Characteristic	Symbol	DB 151S	DB 152S	DB 153S	DB 154S	DB 155S	DB 156S	DB 157S	Units
Typical Thermal Resistance Junction to Ambient	$R_{\theta JA}$	40							$^{\circ}\text{C}/\text{W}$
Typical Thermal Resistance Junction to Lead	$R_{\theta JL}$	15							$^{\circ}\text{C}/\text{W}$
Operating Junction and Storage Temperature Range	T_J, T_{STG}	-55 to + 150							$^{\circ}\text{C}$

Note: 1. Mounted on glass epoxy PC board with 1.3mm² solder pad.
 2. Measured at 1.0 MHz and applied reverse voltage of 4.0 VDC

Ratings and Characteristics Curves

Fig. 1 Output Current Derating Curve

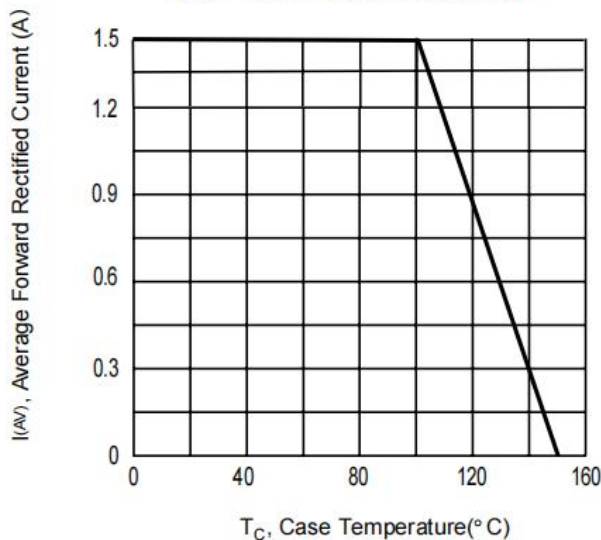

Fig. 2 Typical Forward Characteristics

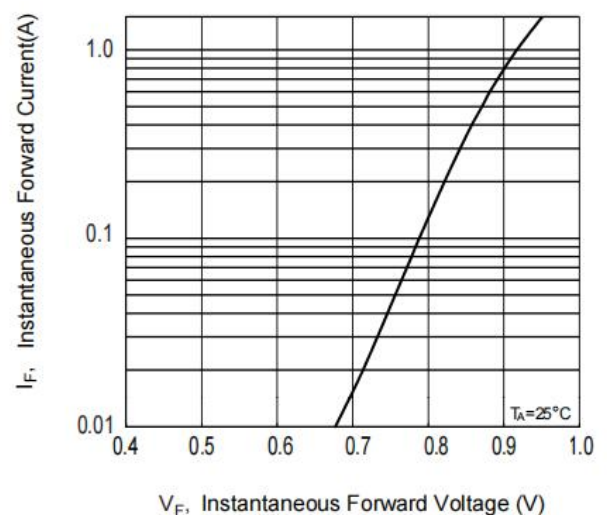

Fig.3 Maximum Peak Forward Surge Current

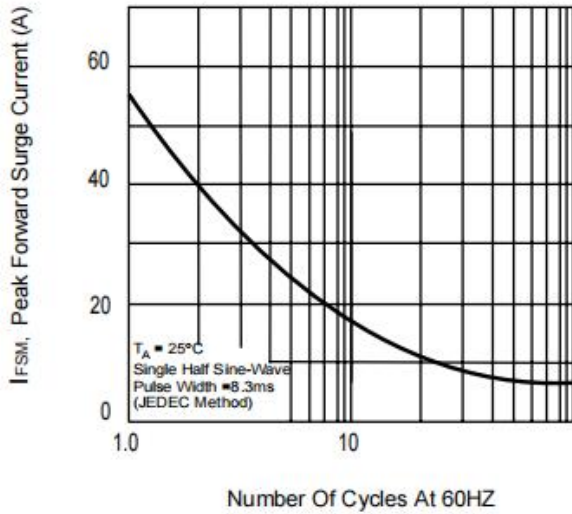

Fig.4 Typical Reverse Characteristics

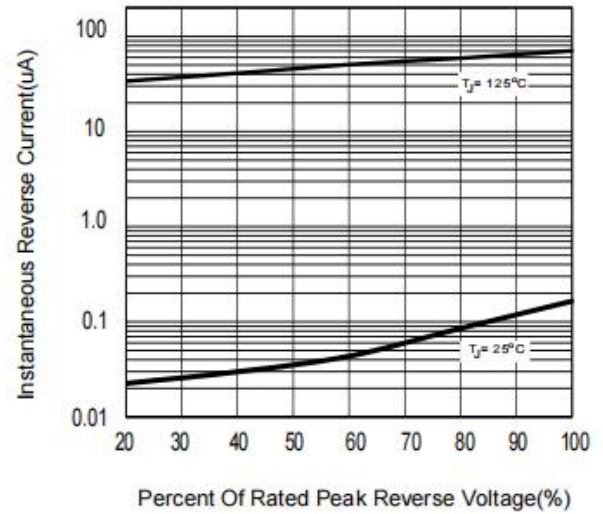
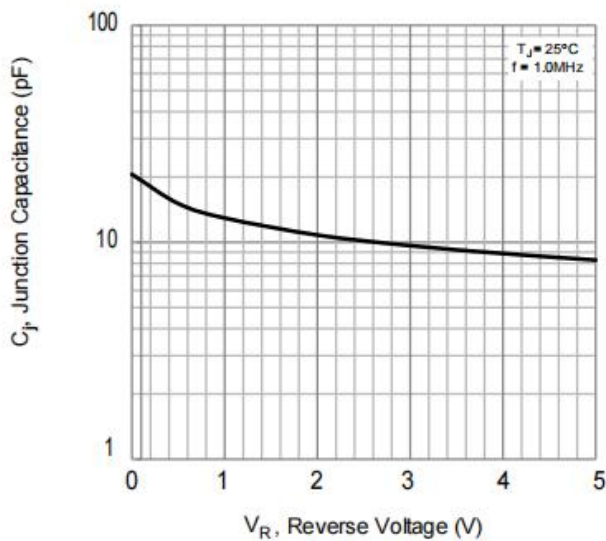
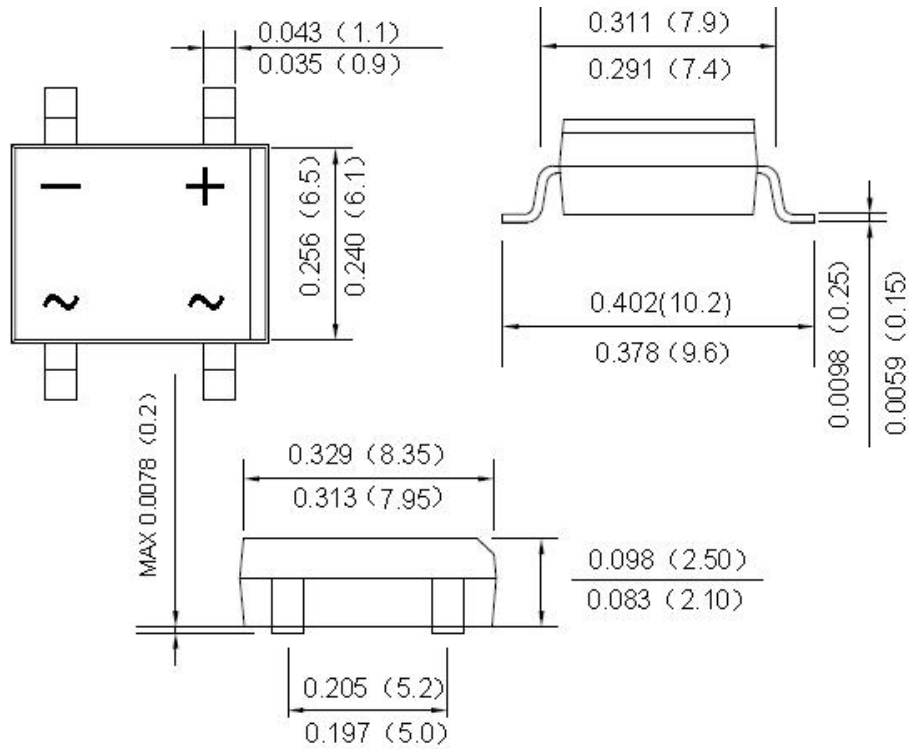

Fig. 5 Typical Junction Capacitance



Mechanical Dimensions DB-S(Inches/Millimeters)



Ordering Information

Device	Package	Plating	Shipping
DB151S THRU DB157S	DB-S (Pb-Free)	Pure Sn	1500pcs / reel

For information on tape and reel specifications, including part orientation and tape sizes, please refer to our tape and reel packaging specification.

Marking Diagram

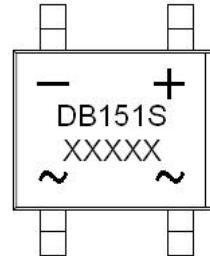

Where XXXXX is YYWWL

DB151S = Type Number
YY = Year
WW = Week
L = Lot Number

Cautions: Molding resin
Epoxy resin UL:94V-0

Carrier Tape Specification DB-S

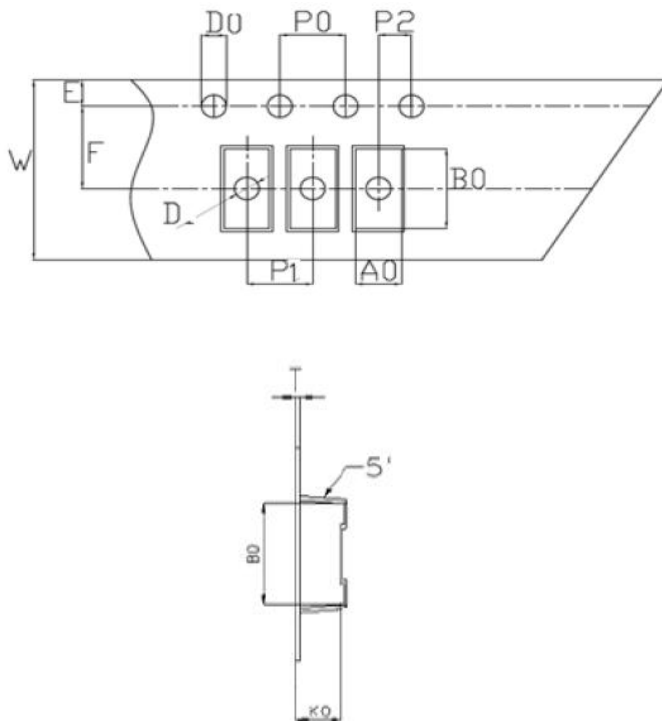



SYMBOL	Millimeters	
	Min.	Max.
A0	8.65	8.95
B0	10.31	10.51
D0	1.50	1.60
D1	1.40	1.60
P0	3.90	4.10
P1	11.90	12.10
P2	1.90	2.10
E	1.65	1.85
K0	3.21	3.41
F	7.40	7.60
W	15.70	16.30
T	0.30	0.40
10P0	39.80	40.20

DISCLAIMER:

- 1- The information given herein, including the specifications and dimensions, is subject to change without prior notice to improve product characteristics. Before ordering, purchasers are advised to contact the SMC Diode Solutions sales department for the latest version of the datasheet(s).
- 2- In cases where extremely high reliability is required (such as use in nuclear power control, aerospace and aviation, traffic equipment, medical equipment, and safety equipment), safety should be ensured by using semiconductor devices that feature assured safety or by means of users' fail-safe precautions or other arrangement.
- 3- In no event shall SMC Diode Solutions be liable for any damages that may result from an accident or any other cause during operation of the user's units according to the datasheet(s). SMC Diode Solution assumes no responsibility for any intellectual property claims or any other problems that may result from applications of information, products or circuits described in the datasheets.
- 4- In no event shall SMC Diode Solutions be liable for any failure in a semiconductor device or any secondary damage resulting from use at a value exceeding the absolute maximum rating.
- 5- No license is granted by the datasheet(s) under any patents or other rights of any third party or SMC Diode Solutions.
- 6- The datasheet(s) may not be reproduced or duplicated, in any form, in whole or part, without the expressed written permission of SMC Diode Solutions.
- 7- The products (technologies) described in the datasheet(s) are not to be provided to any party whose purpose in their application will hinder maintenance of international peace and safety nor are they to be applied to that purpose by their direct purchasers or any third party. When exporting these products (technologies), the necessary procedures are to be taken in accordance with related laws and regulations..

Looking for pricing, stock, or lifecycle information?

Click below to explore more details on WIN SOURCE:

-  [View DB153S on WIN SOURCE](#)
-  [SMC Diode Solutions](#) Information

Optimize Your Supply Chain with WIN SOURCE Solutions

-  Global Sourcing Solution
-  Obsolete Management
-  Cost Control Management
-  Shortage Management
-  Alternative Solution
-  Excess Inventory Management