



**THE DATASHEET OF
AA004-02E**



AA/AB-Series Analog Magnetic Sensors

Equivalent Circuit

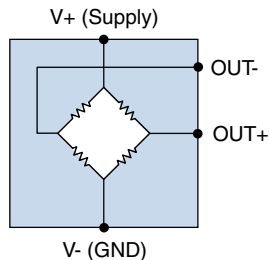

Idealized Transfer Functions

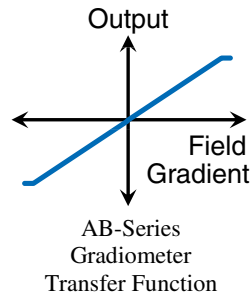
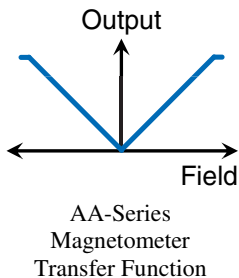

Features

- Magnetometer and gradiometer configurations
- Field ranges from $\ll 0.1$ mT to >400 mT
- Ultrasensitive, high-field, and low-hysteresis versions
- Wheatstone bridge analog outputs
- Operation to near-zero voltage
- Up to 1 MHz bandwidth
- Up to 150°C operating temperature
- ULLGA4, TDFN6, MSOP8, and SOIC8 packages

Applications

- Motion, speed, and position control
- Low-field sensing
- Motor commutator sensors
- Noncontact current sensing

Description

NVE's analog GMR sensors have high sensitivity, excellent temperature stability, and small size. Their versatility and wide sensing range makes them an excellent choice for a variety of analog sensing applications including industrial and automotive position, speed, and current sensors.

The sensors are configured as inherently temperature-compensating Wheatstone bridges.

AA-Series sensors are magnetometers, which detect absolute magnetic field. AB-Series sensors are differential gradiometers, which detect field gradients.

Three magnetometer subtypes are available: the standard AA-Series; the ultrasensitive "H" subtype; the high-field, kilooersted range "K" subtype, and the low-hysteresis "L" subtype.

Packages are as small as an ultraminiature 1.1 x 1.1 mm ULLGA4.

Absolute Maximum Ratings

Parameter		Symbol	Min.	Max.	Units
Supply voltage	AAxxx/ABxxx/AAL002	V _{cc}		24	Volts
	AAHxxx/AAKxxx/ABHxxx/ AAL004/AAL024			12	
Operating temperature	AAxxx/AAKxxx/ABxxx/AALxxx		-50	125	°C
	AAHxxx/ABHxxx			150	°C
Storage temperature	AAxxx/AAKxx/ABxxx/AALxxx		-65	135	°C
	AAHxxx/ABHxxx		-65	150	
ESD (Human Body Model)				400	Volts
Applied magnetic field		H		Unlimited	Tesla
Voltage from sensor connections to center pad (applies to TDFN package only)				63	Volts DC

Operating Specifications

Parameter		Symbol	Min.	Typ.	Max.	Units	Test Condition	
Supply voltage	AAHxxx/AAKxxx/ ABHxxx/AAL004	V _{CC}	<1		12	Volts	Maximum limited by power dissipation	
	AAxxx/ABxxx/AAL002				24			
Operating temperature	AAKxxx	T _{MIN} ; T _{MAX}	-40		85	°C		
	AAxxx/ABxxx/AALxxx				125			
	AAHxxx/ABHxxx				150			
Electrical offset	AAxxx/AAKxxx/AALxxx/ABxxx	V _O	-4		+4	mV/V		
	AAHxxx/ABHxxx				+5			
Output at maximum field	AAxxx/ABxxx	V _{OUT-MAX}		60		mV/V		
	AAHxxx/ABHxxx			40				
	AAKxxx			19				25
	AALxxx			45				
Nonlinearity	AAxxx/AAKxxx/ABxxx/AAL002				2	%	Unipolar field sweep	
	AAHxxx/ABHxxx/AAL0x4				4			
Hysteresis	AAHxxx/ABHxxx				15	%		
	AAxxx/AAKxxx/ABxxx				4			
	AALxxx				2			
Resistance tolerance			-20		+20	%	25°C	
Resistance vs. temperature	AAxxx/ABxxx	TC _R		+0.14		%/°C	No applied field	
	AAHxxx/AAKxxx/ AALxxx/ABHxxx			+0.11				
Output temperature coefficient	AAxxx/ABxxx	TC _{O-I}		+0.03		%/°C	Constant-current supply	
	AAHxxx/ABHxxx			-0.28				
	AAKxxx			+0.13				
	AALxxx			-0.28				
	AAxxx/ABxxx	TC _{O-V}		-0.1		%/°C	Constant-voltage supply	
	AAHxxx/ABHxxx			-0.40				
	AAKxxx			-0.3				
	AALxxx			-0.4				
	AAKxxx	TC _{HSAT}		-0.19		%/°C		
Frequency bandwidth	AAKxxx	f _{MAX}	DC		50	kHz	-3 dB bandwidth	
	AAxxx/AAHxxx				75			
	AALxxx				500			
	ABxxx/ABHxxx				1			MHz
Junction-Ambient thermal resistance	ULLGA4 (-14 suffix)	θ _{JA}			500	°C/W	Soldered to double-sided board; free air	
	TDFN6 (-10 suffix)				320			
	MSOP8 (-00 suffix)				320			
	SOIC8 (-02 suffix)				240			
Power Dissipation	ULLGA4 (-14 suffix)	P _D			100	mW		
	TDFN6 (-10 suffix)				500			
	MSOP8 (-00 suffix)				500			
	SOIC8 (-02 suffix)				675			

Operation

Sensor Subtypes

There are four AA/AB-Series subtypes, as summarized in the table below. “H” subtypes are designed for very high sensitivity, and “K” types have low sensitivity and high saturation for high-field sensing. “L” types offer low hysteresis. AAH-Series parts also have a 150°C maximum temperature specification.

Parameter	AAxxx/ ABxxx	AAHxxx/ ABHxxx	AAKxxx	AAHxxx
Field Sensitivity	High	Very High	Low	High
Operating Field Range	High	Low	Very High	Medium
Hysteresis	Medium	High	Medium	Low
Max. Temperature	High	Very High	Commercial	High

Magnetometer Operation

AA-Series sensors are *magnetometers*, which detect the absolute magnetic field.

Direction of Sensitivity

Unlike Hall effect or other sensors, the direction of sensitivity of GMR sensors is in the plane of the package, which more convenient for many applications. Two permanent magnet orientations that will activate the sensor are shown in Figure 1:

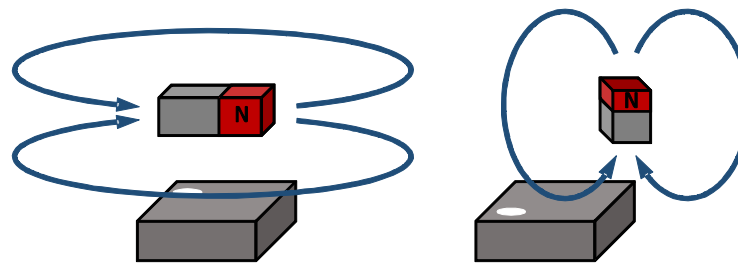

Figure 1. Planar magnetic sensitivity.

Omnipolar

AA-Series sensors are “omnipolar,” meaning the output is equally sensitive to either magnetic field polarity and the output is always a positive voltage:

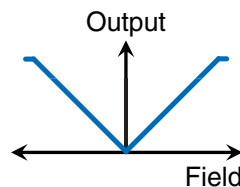

Figure 2. The omnipolar response of AA-Series sensors.

Standard and Cross-Axis Directional Sensitivity

The standard axis of sensitivity is along the part axis, but there are some parts available with cross-axis sensitivity, and AAKxxx sensors are not directionally sensitive in the IC plane, and are therefore sensitive in both standard and cross-axis axis directions.

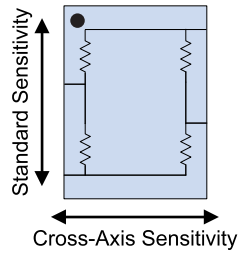

Figure 3. Standard versus cross-axis-sensitivity for AA-Series sensors.

Gradiometer Operation

AB-Series sensors are differential *gradiometers* that reject common mode magnetic fields, making them ideal for high magnetic noise environments such as near electric motors or current-carrying wires. The devices are sensitive to a field gradient along the part axis.

The figure below shows a typical gradiometer response:

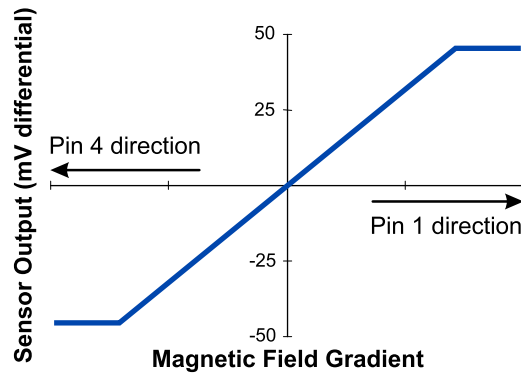

Figure 4. Typical AB-Series gradiometer response.

Typical Performance Graphs

Figures 5–7 show the response of three types of high-sensitivity models. The standard version, the AA002, has excellent temperature stability, especially with constant-current drive. The AAH002 has very high sensitivity but more temperature dependence, and the AAL002 offers low hysteresis at the expense of more temperature dependence:

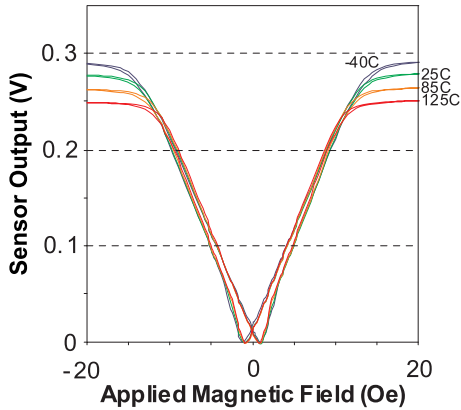

Figure 5a. Typical AA002 output with 1 mA constant-current drive.

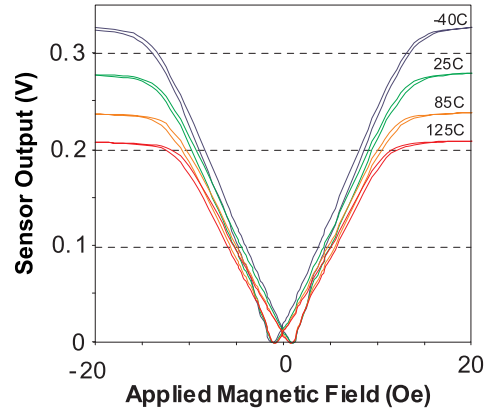

Figure 5b. Typical AA002 output with a 5V supply.

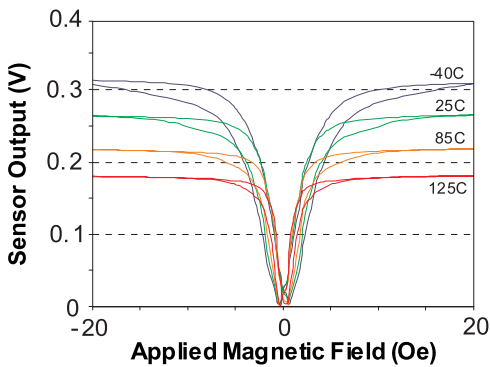

Figure 6a. Typical AAH002 output with 2.28 mA constant-current drive.

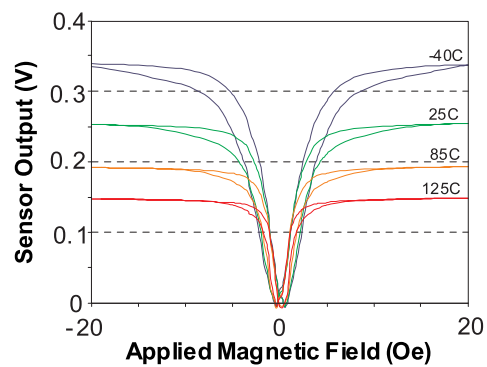

Figure 6b. Typical AAH002 output with a 5V supply.

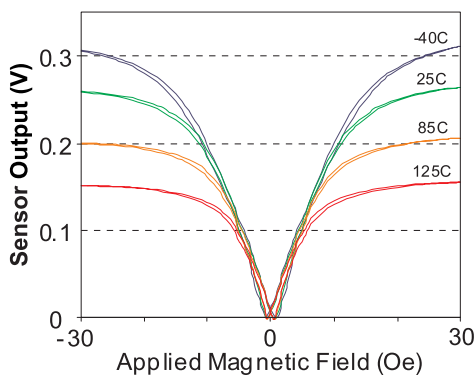

Figure 7a. Typical AAL002 output with 1 mA constant-current drive.

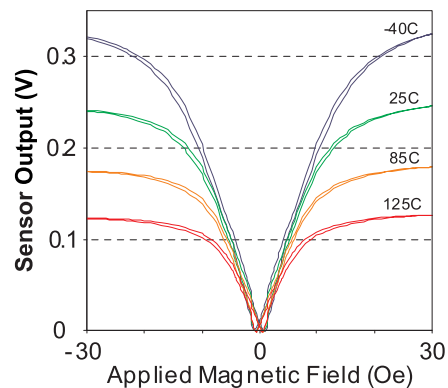

Figure 7b. Typical AAL002 output with a 5V supply.

Figure 8 shows the typical output of an AAK001 high-field sensor. The sensor responds from zero field to 400 mT (4 kOe), and is highly linear from (40 to 250 mT) (400 to 2.5 kOe). The saturation field is dependant on temperature, but sensitivity is quite stable with temperature.

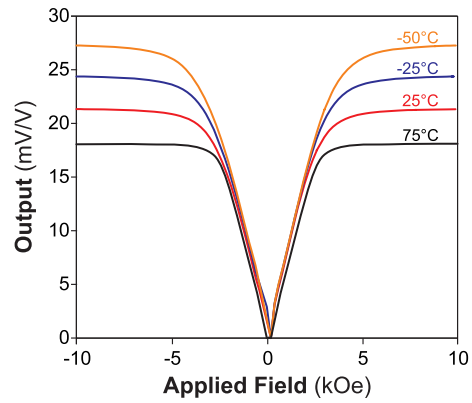

Figure 8. AAK001 high-field sensor output.

Illustrative Applications

Traditional Differential Amplifier

Traditional differential amplifiers use low-cost op-amps to provide a single-ended analog output. The circuit below has a gain of 20, which provides a full-scale output at slightly less than the sensor's saturation. A low-cost, low bias current op amp allows large resistors to avoid loading the sensor bridge. The 250 KΩ input resistors are 100 times the 2.5 KΩ sensor output impedance to avoid loading.

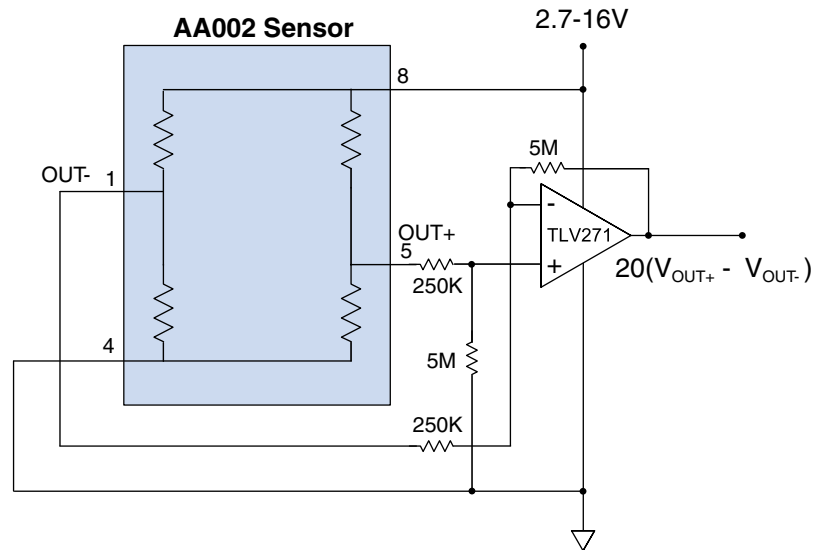

Figure 9. Traditional op-amp differential amplifier.

Sensor Instrumentation Amplifier

Instrumentation amplifiers such as the INA826 are popular bridge sensor preamplifiers because they have a low component count and have excellent common-mode rejection ratios without needing to match resistors. These amplifiers can run on single or dual supplies. AC coupling can be used for small, dynamic signals.

The circuit below has a gain of 20. The general equation for the output voltage is:

$$V_{OUT} = (1 + 49.4K / R_G)V_{IN} + V_{REF}; V_{IN} = V_{OUT+} - V_{OUT-}$$

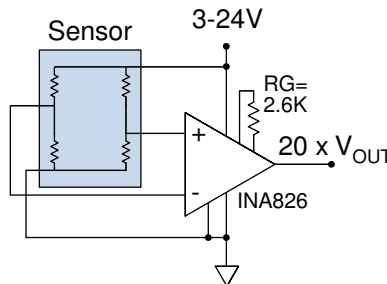

Figure 10. Single-ended analog sensor instrumentation amplifier.

Note that the instrumentation amplifier has a minimum output of 0.1V, so to detect very low fields on a single supply, an offset can be provided by using a non-zero V_{REF} .

Constant-Current Sensor Drive

Using a constant current rather than conventional constant voltage sensor supply can significantly improve temperature stability of AAxxx/ABxxx sensors. AA00x sensors, for example, have an output temperature coefficient (TC_{O-I}) of 0.03%/°C with constant current, versus -0.1%/°C with constant voltage (TC_{O-V}).

A simple constant-current supply is illustrated below:

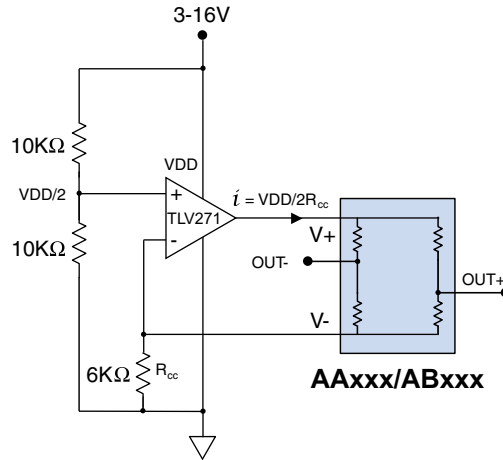

Figure 11. Constant-current supply.

The supply current for the circuit above is $V_{cc}/2R_{cc}$. R_{cc} can be set to the maximum sensor bridge resistance (e.g., 6 KΩ for many sensors) to provide the highest possible output without saturating the op-amp. The sensor will be driven with 1 mA for a 12 V supply in the circuit above. Op-amp or instrumentation amplifiers such as those illustrated in Figures 9 and 10 can be used with constant-current supplies to provide an amplified, single-ended output.

Variable Threshold Magnetic Switch

NVE offers AD-Series factory-set GMR Switches, but AA-Series analog sensors can be used for special thresholds or hysteresis, or for variable thresholds. In this circuit, the threshold is varied by changing R_G , which sets the gain of the differential amplifier. The 1 MΩ resistor sets the threshold hysteresis:

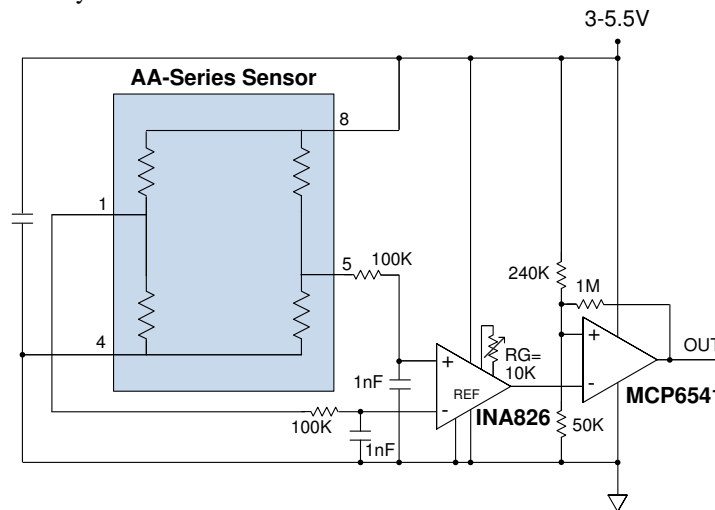

Figure 12. Variable threshold magnetic switch.

LED Field-Strength Indicator

The op-amp circuit in Figure 13 below can be used to change the brightness of an LED to indicate magnetic field strength at a glance:

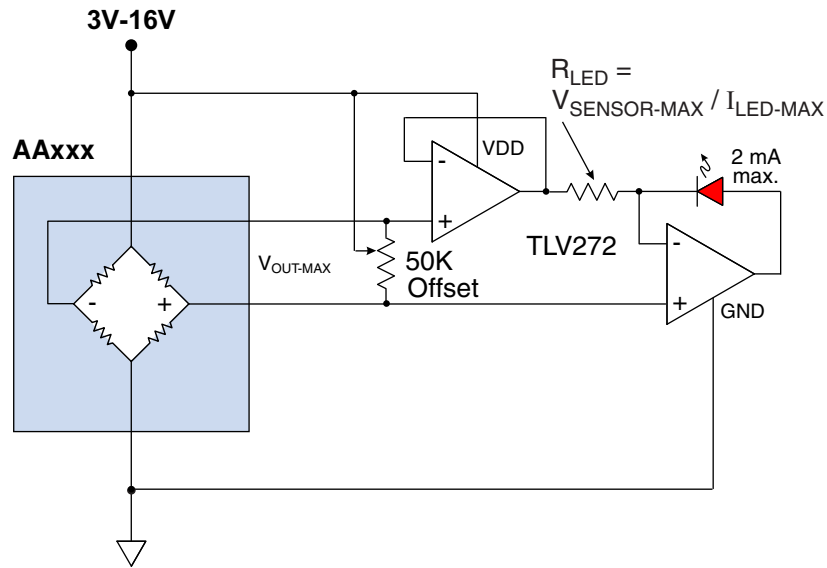

Figure 13. LED brightness indicates the magnetic field.

The LED current is proportional to the sensor output:

$$I_{LED} = (V_{OUT+} - V_{OUT-}) / R_{LED}$$

The maximum LED current can be set to the maximum sensor output. For example, for an AAK001, typical $V_{OUT-MAX}$ is 25 mV/V, so for a three-volt supply the maximum is approximately 75 mV. For a high-efficiency with a forward current of 2 mA, $R_{LED} = 75 \text{ mV} / 2 \text{ mA} = 38\Omega$.

The 50 K Ω potentiometer is optional, to correct for sensor offset or to set the minimum field to turn on the LED.

The 16-volt maximum supply voltage noted in Figure 13 is limited by the op-amp selected, but note that some sensors have a 12-volt maximum supply rating. The three-volt minimum supply is to provide enough voltage to turn on the LED; the sensors can operate on lower voltages.

Noncontact Current Sensing

AA-Series sensors are often used to measure the current over a circuit board trace. The sensor measures the current by detecting the magnetic field generated by the current through the trace.

The AAL024 is ideal for this application because its cross-axis sensitivity provides sensitivity to a current trace directly under the part, and its low hysteresis provides repeatability. The AA003-02 is popular for overcurrent protection where hysteresis is needed and high accuracy is not required.

Typical current sensing configurations are shown below:



**Figure 14a. 0.09" (2.3 mm) trace
(0 – 10 A with an AA003 sensor)**



**Figure 14b. 0.05" (1.3 mm) trace
(0 – 5 A with an AAL024 sensor).**

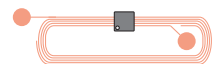

**Figure 14c. Five turns of
0.0055" (0.14 mm) trace
(0 – 1 A with an AAL024 sensor).**

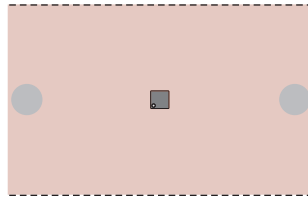

**Figure 14d. 1" (25 mm) trace on the bottom side of the PCB
(0 – 50 A with an AAL024 sensor).**

For the geometry shown in Figure 15 and narrow traces with, the magnetic field generate can be approximated by Ampere’s law:

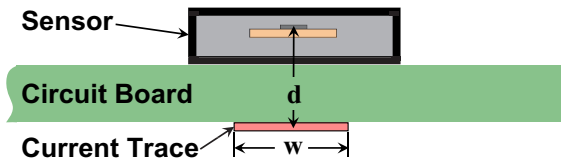

Figure 15. The geometry of current-sensing over a circuit board trace.

$$H = \frac{2I}{d} \quad [“H” \text{ in oersteds, “I” in amps, and “d” in millimeters}]$$

The trace can also be run on the top side of the PCB for more current sensitivity.

More precise calculations can be made by breaking the trace into a finite element array of thin traces, and calculating the field from each array element. We have a free, Web-based application with a finite-element model to estimate magnetic fields and sensor outputs in this application:

www.nve.com/spec/calculators.php#tabs-Current-Sensing

Part Numbering

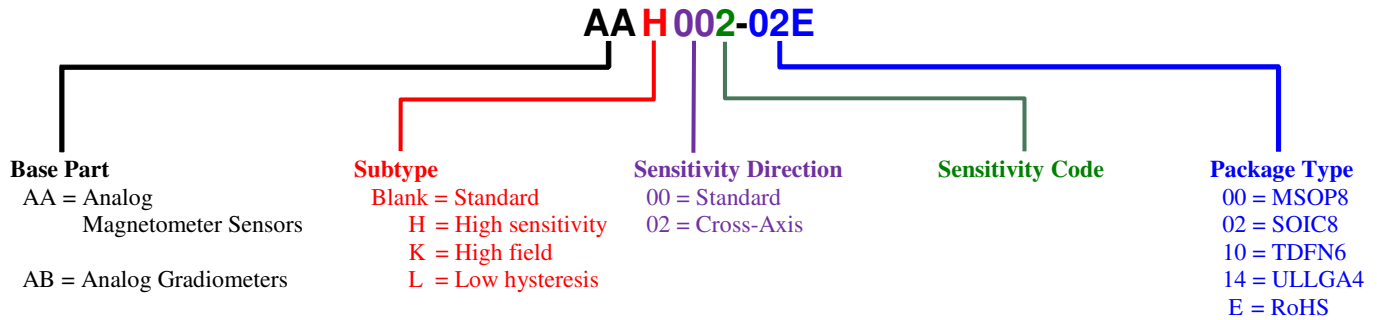

Direction of Sensitivity

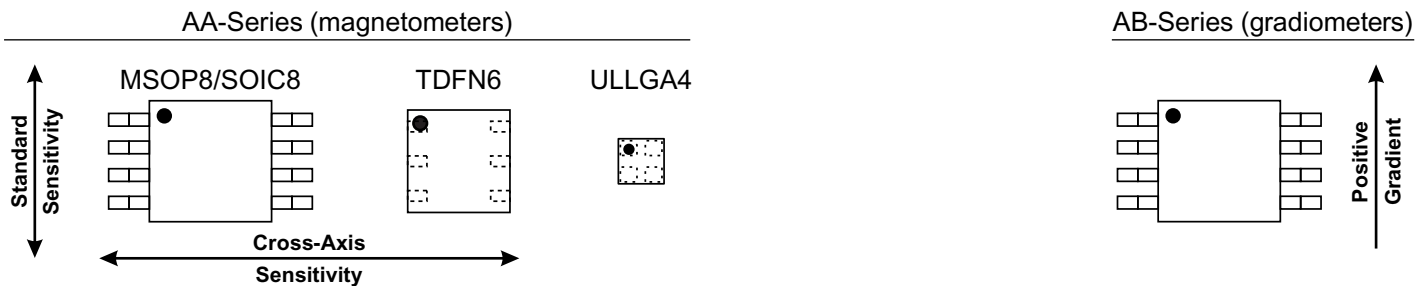

Pinouts

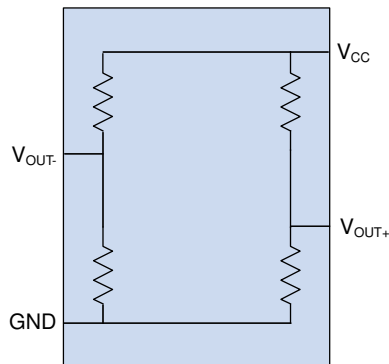

AA-Series Pinout						Symbol	Description
Sensitivity							
Standard (AAx00x-xx)			Cross-Axis (AAx02x-xx)				
ULLGA	MSOP/SOIC	TDFN	MSOP/SOIC	TDFN			
3	1	1	5	4	V _{OUT-}	Negative bridge output (decreases with increasing field).	
	2	2	2	2	NC	No internal connection.	
	3		3				
4	4	3	4	3	V-/GND	Negative supply or ground.	
1	5	4	1	1	V _{OUT+}	Positive bridge output (increases with field).	
	6	5	6	5	NC	No internal connection.	
	7		7				
2	8	6	8	6	V+	Positive supply voltage.	
		Center Pad		Center Pad	NC	Internally connected to leadframe	

AB-Series Pinout		
Pin	Symbol	Description
1	V _{OUT-}	Negative bridge output (decreases with gradient).
2	NC	No internal connection.
3		
4	V-/GND	Negative supply or ground.
5	V _{OUT+}	Positive bridge output (increases with gradient).
6	NC	No internal connection.
7		
8	V+	Positive supply.

AA-Series Sensor Selector Chart

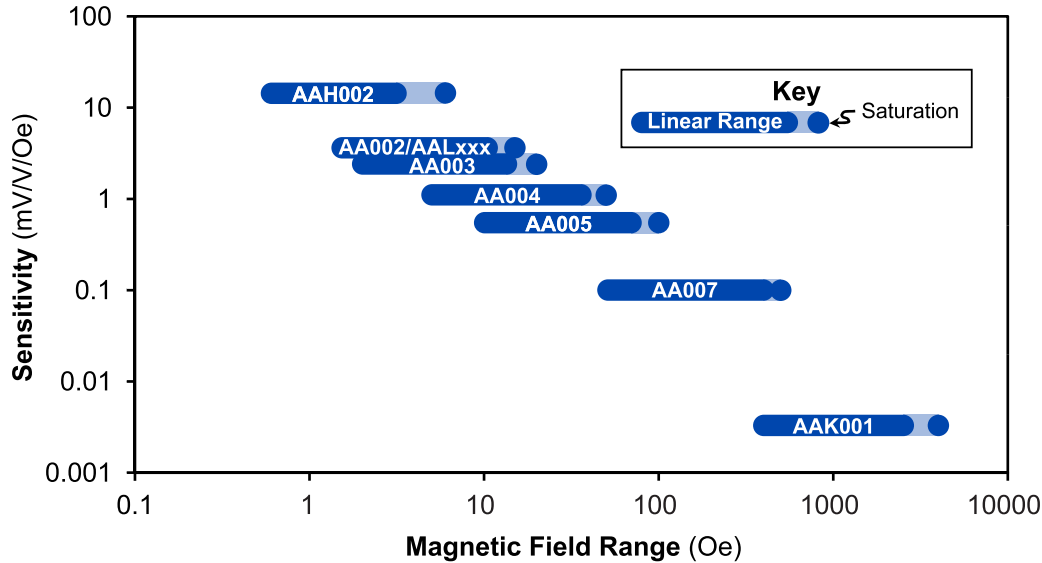

Available Parts

Magnetometers (AA-Series)										
Available Part	Linear Range (IOel)		Saturation (IOel)	Sensitivity (mV/V-Oe)		Max. Non-linearity (% Uni.)	Max. Hysteresis (% Uni.)	Max. Operating Temp.	Typ. Resistance	Package
	Min.	Max.		Min.	Max.					
AA002-02	1.5	10.5	15	3	4.2	2%	4%	125°C	5 kΩ	SOIC8
AA003-02	2	14	20	2	3.2	2%	4%	125°C	5 kΩ	SOIC8
AA004-00	5	35	50	0.9	1.3	2%	4%	125°C	5 kΩ	MSOP8
AA024-00	5	35	50	0.9	1.3	2%	4%	125°C	5 kΩ	MSOP8 (cross-axis)
AA004-02	5	35	50	0.9	1.3	2%	4%	125°C	5 kΩ	SOIC8
AA005-02	10	70	100	0.45	0.65	2%	4%	125°C	5 kΩ	SOIC8
AA006-00	5	35	50	0.9	1.3	2%	4%	125°C	30 kΩ	MSOP8
AA006-02	5	35	50	0.9	1.3	2%	4%	125°C	30 kΩ	SOIC8
AA007-00	50	450	500	0.08	0.12	2%	4%	125°C	5 kΩ	MSOP8
AAH002-02	0.6	3	6	11	18	4%	15%	150°C	2 kΩ	SOIC8
AAH004-00	1.5	7.5	15	3.2	4.8	4%	15%	150°C	2 kΩ	MSOP8
AAL002-02	1.5	10.5	15	3	4.2	2%	2%	125°C	5.5 kΩ	SOIC8
AAL004-10	1.5	10.5	15	3	4.2	4%	2%	125°C	2.2 kΩ	TDFN6
AAL024-10	1.5	10.5	15	3	4.2	4%	2%	125°C	2.2 kΩ	TDFN6 (cross-axis)
AAK001-14	400	2500	4000	0.0025	0.004	2%	4%	85°C	3.5 kΩ	ULLGA4

Gradiometers (AB-Series)										
Available Part	Linear Range (IOel)		Saturation (IOel)	Sensitivity (%R/Oe)		Max. Non-linearity (% Uni.)	Max. Hysteresis (% Uni.)	Max. Operating Temp.	Typ. Resistance	Package
	Min.	Max.		Min.	Max.					
AB001-02	10	175	250	0.02	0.03	2%	4%	125°C	2.5 kΩ	SOIC8
AB001-00	10	175	250	0.02	0.03	2%	4%	125°C	2.5 kΩ	MSOP8
ABH001-00	5	40	70	0.06	0.12	4%	15%	150°C	1.2 kΩ	MSOP8

Note: 1 Oe = 0.1 mT in air.

Evaluation Kits

Four inexpensive evaluation kits including AA- or AB-Series analog sensors are available:

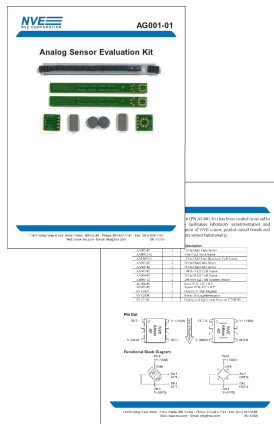

AG001-01: Analog Sensor Evaluation Kit

This kit features several types of NVE's AA and AB series parts, a selection of permanent magnets for activation or bias purposes, and circuit boards to mount the parts for testing.

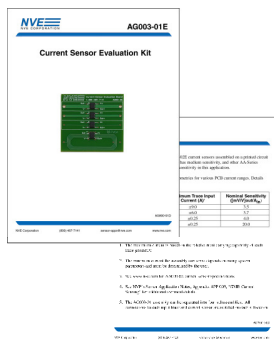

AG003-01: AA003 Current Sensor Evaluation Kit

This kit features a circuit board with different trace configurations running under four AA003-02E analog sensors to evaluate the sensor as non-contact current sensors. The board supports current ranges of 0–9 amps, 0–6 amps, and 0–250 milliamps. Boards measure 2 by 1.85 inches (51 mm by 47 mm), and include four sensors.

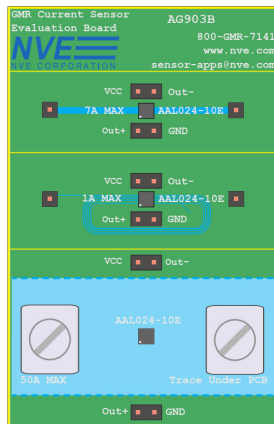

AG903B-01: GMR Current Sensor Evaluation Kit

This board includes three AAL024-10E TDFN current sensors on a PCB with three current-trace configurations. The board supports current ranges of 0–0.75 amp, 0–5 amps, and 0–50 amps. The boards measure 1.565" x 2.915" (40 mm by 74 mm) and include sensor power and output connections, and plus connections for the current to be measured.

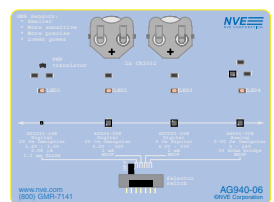

AG940-07E: Digital/Analog/Omnipolar/Bipolar Sensor Demo Board

The kit includes a demo board with our most popular digital, analog, omnipolar, and bipolar sensors, including an AA006-00E analog sensor. Each sensor drives an indicator LED. A bar magnet is included so you can see for yourself how the sensors work. The evaluation boards are 3.75 by 5 inches (95 mm by 127 mm), and are powered by two coin cells (included).

Bare Circuit Boards for Sensors

NVE offers several bare circuit boards specially designed for easy connections to surface-mount sensors. Popular PCBs are shown below (images are actual size):



AG004-06: 3" x 0.3" (75 x 8 mm) SOIC8 circuit board

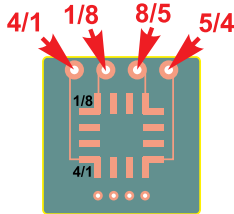

AG005-06:
0.5" x 0.5" (13 mm x 13 mm)
SOIC8



AG915-06:
0.25" (6 mm) octagonal
MSOP8



AG918-06 (standard) / AG919-06 (cross-axis):
2" x 0.25" (50 mm x 6 mm) MSOP8



AG035-06:
1.57" x 0.25" (40 mm x 6 mm) TDFN6



AG904-06:
1.2" x 0.25" (30 mm x 6 mm)
ULLGA

Package Drawings

ULLGA4 (-14E suffix)

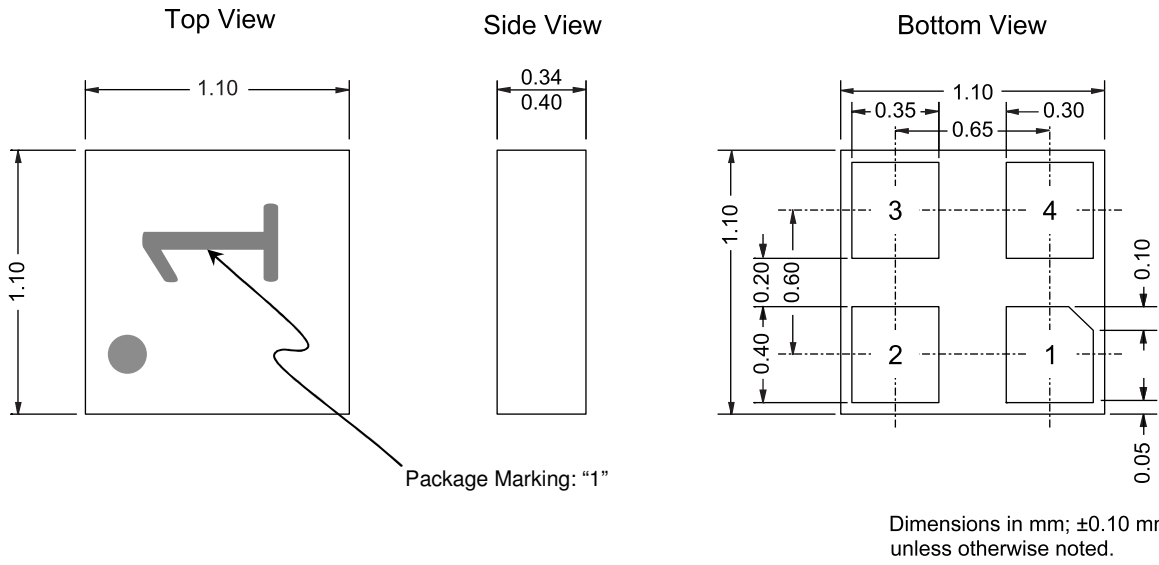

RoHS
COMPLIANT

TDFN6 (-10 suffix)

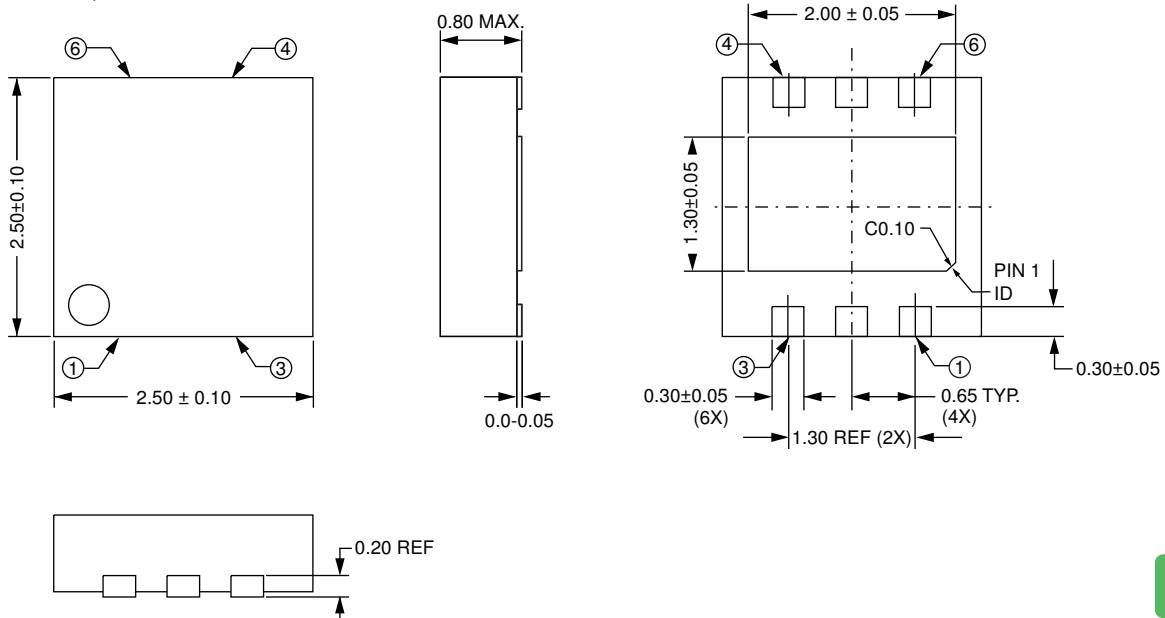

RoHS
COMPLIANT

MSOP8 (-00 suffix)

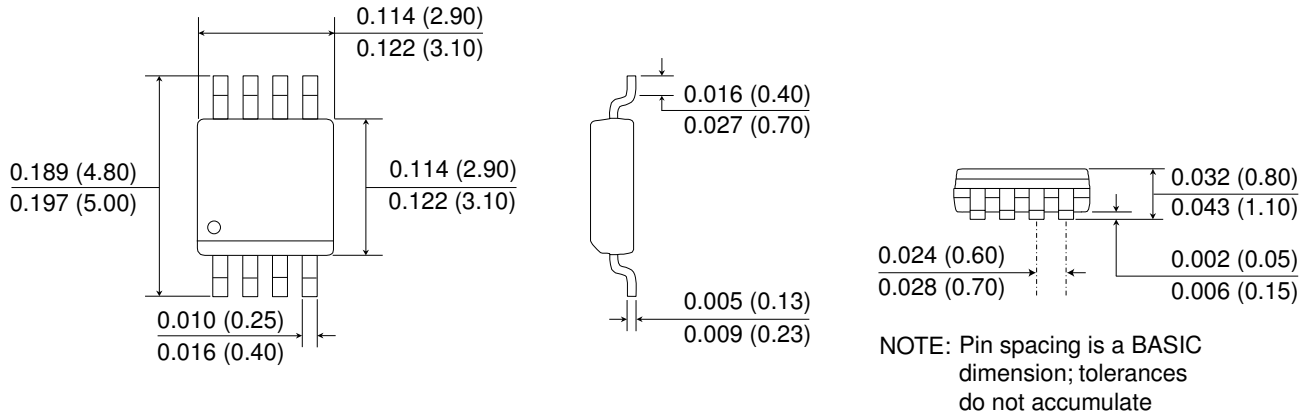

SOIC8 (-02 suffix)

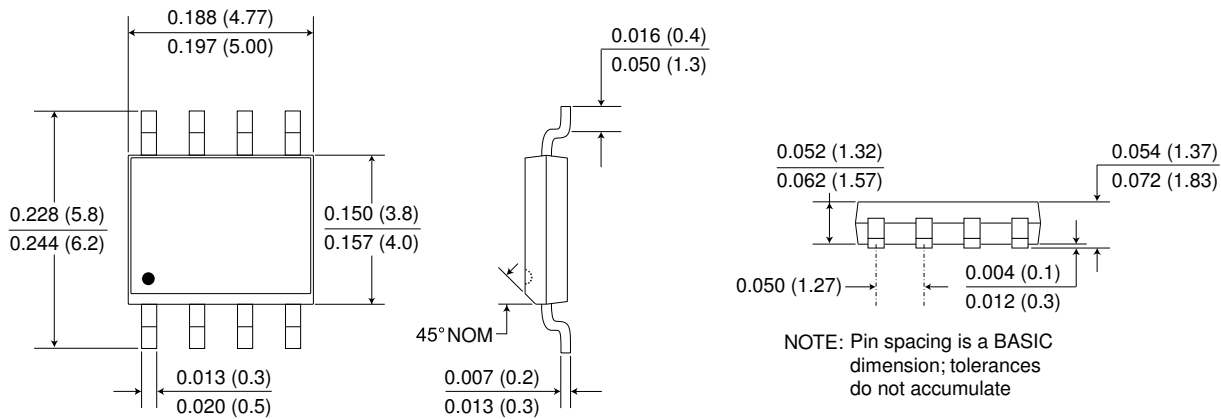

RoHS
COMPLIANT

RoHS
COMPLIANT

Soldering profiles per JEDEC J-STD-020C, MSL 1.

Revision History

SB-00-059-G

July 2019

Change

- Added SI units (mT) where appropriate.
- Added higher current-sensing trace illustration (p. 11).
- Revised AG903B-01 current sensor evaluation kit (p. 14).

SB-00-059-F

October 2018

Change

- Improved AAL-Series bandwidth specification; specified –3 dB bandwidth (p. 3).
- Added AG903B high-current evaluation kit (p. 14).

SB-00-059-E

January 2018

Change

- Added Absolute Maximum isolation specification for TDFN package (p. 2).
- Added TDFN Center Pad description (p. 12).
- Updated AAL004 and AAL024 linearity specification (p. 13).

SB-00-059-D

October 2017

Change

- Added AAK001 ultrahigh-field model.
- Added LED field-strength indicator and current-sensing applications (p. 10).
- Added AA selector chart (p. 13).
- Added Evaluation Kits (p. 14) and bare circuit boards (p. 15).
- Misc. cosmetic changes and additional illustrations.

SB-00-059-C

September 2017

Change

- Added AA007-00E high-field model.

SB-00-059-B

August 2017

Change

- Added AA024-10E and AAL024-10E cross-axis versions.

SB-00-059-A

April 2017

Change

- Initial datasheet release superseding catalog.

Datasheet Limitations

The information and data provided in datasheets shall define the specification of the product as agreed between NVE and its customer, unless NVE and customer have explicitly agreed otherwise in writing. All specifications are based on NVE test protocols. In no event however, shall an agreement be valid in which the NVE product is deemed to offer functions and qualities beyond those described in the datasheet.

Limited Warranty and Liability

Information in this document is believed to be accurate and reliable. However, NVE does not give any representations or warranties, expressed or implied, as to the accuracy or completeness of such information and shall have no liability for the consequences of use of such information.

In no event shall NVE be liable for any indirect, incidental, punitive, special or consequential damages (including, without limitation, lost profits, lost savings, business interruption, costs related to the removal or replacement of any products or rework charges) whether or not such damages are based on tort (including negligence), warranty, breach of contract or any other legal theory.

Right to Make Changes

NVE reserves the right to make changes to information published in this document including, without limitation, specifications and product descriptions at any time and without notice. This document supersedes and replaces all information supplied prior to its publication.

Use in Life-Critical or Safety-Critical Applications

Unless NVE and a customer explicitly agree otherwise in writing, NVE products are not designed, authorized or warranted to be suitable for use in life support, life-critical or safety-critical devices or equipment. NVE accepts no liability for inclusion or use of NVE products in such applications and such inclusion or use is at the customer's own risk. Should the customer use NVE products for such application whether authorized by NVE or not, the customer shall indemnify and hold NVE harmless against all claims and damages.

Applications

Applications described in this datasheet are illustrative only. NVE makes no representation or warranty that such applications will be suitable for the specified use without further testing or modification.

Customers are responsible for the design and operation of their applications and products using NVE products, and NVE accepts no liability for any assistance with applications or customer product design. It is customer's sole responsibility to determine whether the NVE product is suitable and fit for the customer's applications and products planned, as well as for the planned application and use of customer's third party customers. Customers should provide appropriate design and operating safeguards to minimize the risks associated with their applications and products.

NVE does not accept any liability related to any default, damage, costs or problem which is based on any weakness or default in the customer's applications or products, or the application or use by customer's third party customers. The customer is responsible for all necessary testing for the customer's applications and products using NVE products in order to avoid a default of the applications and the products or of the application or use by customer's third party customers. NVE accepts no liability in this respect.

Limiting Values

Stress above one or more limiting values (as defined in the Absolute Maximum Ratings System of IEC 60134) will cause permanent damage to the device. Limiting values are stress ratings only and operation of the device at these or any other conditions above those given in the recommended operating conditions of the datasheet is not warranted. Constant or repeated exposure to limiting values will permanently and irreversibly affect the quality and reliability of the device.

Terms and Conditions of Sale

In case an individual agreement is concluded only the terms and conditions of the respective agreement shall apply. NVE hereby expressly objects to applying the customer's general terms and conditions with regard to the purchase of NVE products by customer.

No Offer to Sell or License

Nothing in this document may be interpreted or construed as an offer to sell products that is open for acceptance or the grant, conveyance or implication of any license under any copyrights, patents or other industrial or intellectual property rights.

Export Control

This document as well as the items described herein may be subject to export control regulations. Export might require a prior authorization from national authorities.

Automotive Qualified Products

Unless the datasheet expressly states that a specific NVE product is automotive qualified, the product is not suitable for automotive use. It is neither qualified nor tested in accordance with automotive testing or application requirements. NVE accepts no liability for inclusion or use of non-automotive qualified products in automotive equipment or applications.

In the event that customer uses the product for design-in and use in automotive applications to automotive specifications and standards, customer (a) shall use the product without NVE's warranty of the product for such automotive applications, use and specifications, and (b) whenever customer uses the product for automotive applications beyond NVE's specifications such use shall be solely at customer's own risk, and (c) customer fully indemnifies NVE for any liability, damages or failed product claims resulting from customer design and use of the product for automotive applications beyond NVE's standard warranty and NVE's product specifications.

An ISO 9001 Certified Company

NVE Corporation
11409 Valley View Road
Eden Prairie, MN 55344-3617 USA
Telephone: (952) 829-9217
www.nve.com
www.youtube.com/NveCorporation

e-mail: sensor-info@nve.com

©NVE Corporation

All rights are reserved. Reproduction in whole or in part is prohibited without the prior written consent of the copyright owner.

SB-00-059_RevG

July 2019

Looking for pricing, stock, or lifecycle information?

Click below to explore more details on WIN SOURCE:

 [View AA004-02E on WIN SOURCE](#)

 [NVE Corp Information](#)

Optimize Your Supply Chain with WIN SOURCE Solutions

-  Global Sourcing Solution
-  Obsolete Management
-  Cost Control Management
-  Shortage Management
-  Alternative Solution
-  Excess Inventory Management