



**THE DATASHEET OF
ATP19-SL1-324-B0SE-03Q**



ATP19 Series

Anti-Vandal Sealed Pushbutton Switches



Agency Approvals

Agency	Agency File Number
	E42363

Specifications

Function	Single pole and double poles
Contact Arrangement	N.O. And N.C.
Mounting Type	Threaded front panel mount
Torque for Threaded Body	5-14 Nm

Mechanical Specifications

Mechanical Life	Momentary 1,000,000 cycles Self-lock 500,000 cycles
Total Travel	About 3.2 mm
Operating Force	1 pole 2.5 ± 1N 2 pole 3.5 ± 1N

Electrical Specifications

Contact Rating	1th 5A/250VAC 3A / 250VAC 3A / 28VDC
Operating Life	50,000 make-and-break cycles at full load
Dielectric Strength	2,000 V RMS @ sea level
Insulation Resistance	1,000 MΩ min. @ 500 VDC
Initial Contact Resistance	50 mΩ max @ 1A 12 VDC
Operating Temperature	-20°C to 55°C
Sealing / Protection	IP67 / IK10 (Stainless steel bushing)

Notes:

Specifications and materials listed above are for switches with standard options. For information on specific and custom switches, please contact Customer Service.

Description

The ATP19 series is an anti-vandal sealed pushbutton switch that offers the industry standard ring illuminated version in 19 mm diameter. The pushbutton switches use a scratch resistant actuator and housings are made of robust stainless steel particularly suitable for use in equipment subjected to harsh conditions or applications that require protection from vandalism. The 19 mm pushbuttons meet the seal protection and impact resistance ratings of IP67 and IK10 that design to withstand the possible extreme outdoor environmental and may subject to abuse. Also, the ATP19 comes with a variety of LED colors as illuminated pushbuttons and various of indicators on the actuator that meet your application needs.

Features & Benefits

- Momentary or Lock version
- IP67 sealed & IK10 (Stainless steel bushing)
- Capable of up to 3A resistive load
- 50,000 life cycle at full load
- Various colors of LED illuminate indicator
- Choices of pushbutton with symbol on spot, ring or power logo

Applications

- Control Panels including car park and traffic light
- Industrial Instruments
- Lifts / Escalator
- Communication equipment
- Alarm, safety and security systems

Materials

Bushing	Stainless steel / Nickel plated brass / Aluminum alloy
Base	PBT (UL 94-A0), PC (UL 94-V2)
Actuator	PC, (UL 94-V2); Stainless steel / Nickel plated brass / Aluminum alloy
Internal Assembly	POM / PA66
Spring	Steel
Sealing / O-ring	Silicone
Terminals	Brass with silver or gold plated
Contact	Copper, silver plated

ATP19 Series

Anti-Vandal Sealed Pushbutton Switches



Ordering Number

To order, simply select desired option from each category and place in the appropriate box.

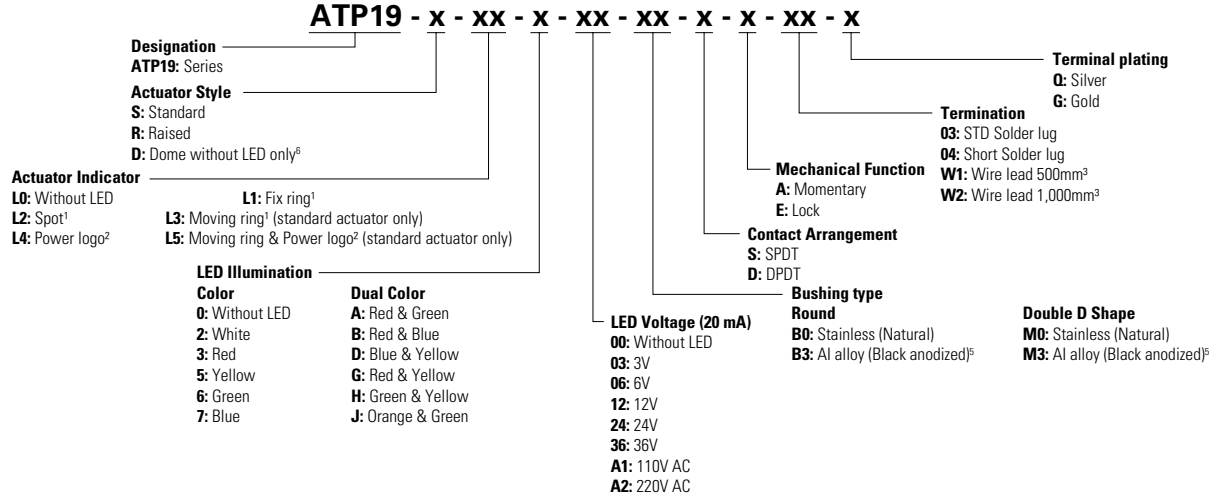

Notes:

1. Available on round bushing only
2. Available on double D-shape bushing only
3. Available upon request, please contact your sales representative for details
4. Come in B0 & M0 with L1 or L4 indicator only
5. Come in S style actuator only & no L5 indicator
6. Without LED & for B0 & M0 bushing type only

Standard View - Dimensions inches (mm)

Round Bushing

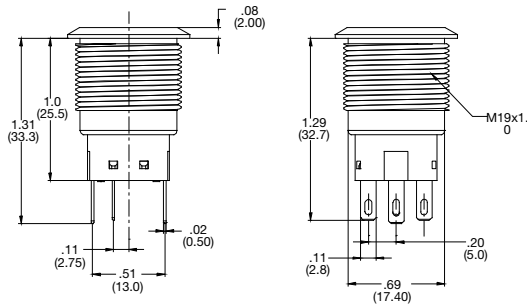

Double-D Bushing

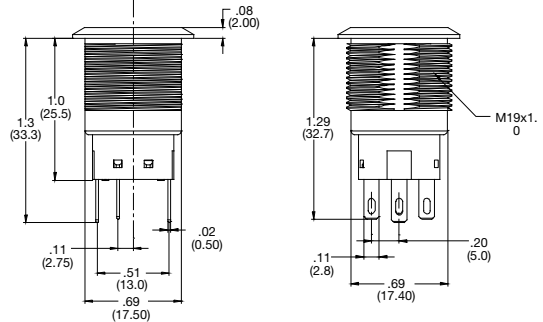

Actuator Style - Dimensions inches (mm)

S Standard

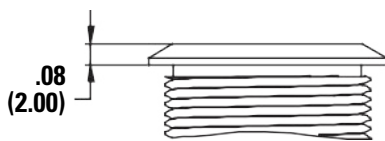

R Raised

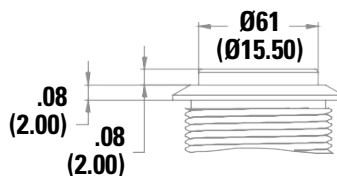

D Dome

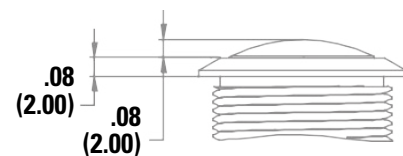

ATP19 Series

Anti-Vandal Sealed Pushbutton Switches



Actuator Indicator - Dimensions inches (mm)

L0 Without LED

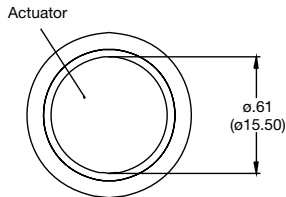

L1 Fix Ring

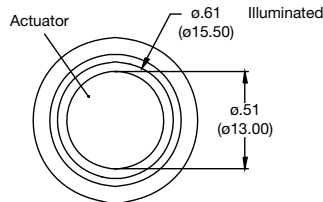

L3 Moving Ring

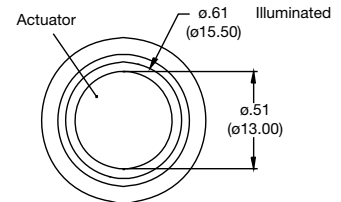

L2 Spot

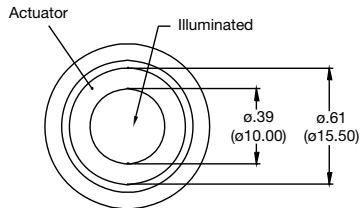

L4 Power Logo

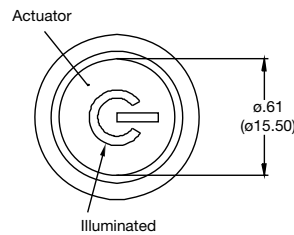

L5 Power & Moving Ring

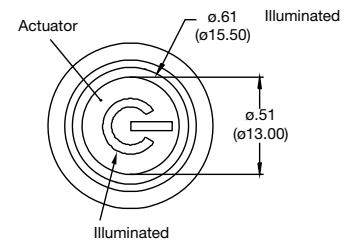

Circuit

SPDT

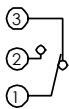

SPDT - Single Color LED

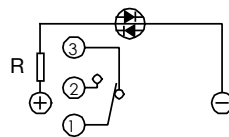

SPDT - Dual Color LED

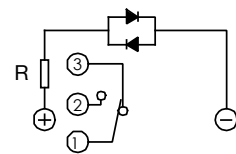

DPDT

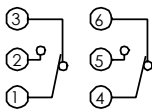

DPDT - Single Color LED

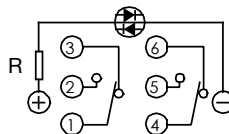

DPDT - Dual Color LED

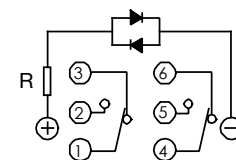

ATP19 Series

Anti-Vandal Sealed Pushbutton Switches



Termination - Dimensions inches (mm)

03 Solder Lug

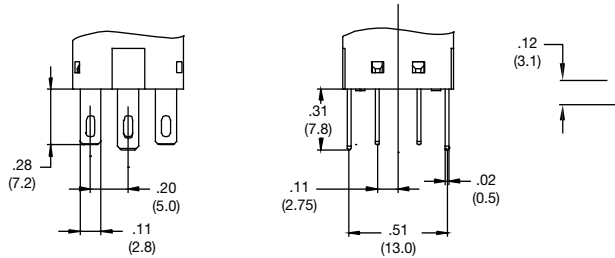

04 Short Solder Lug

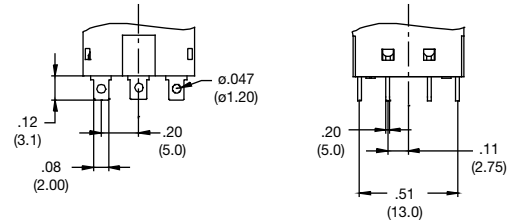

W1 or W2 Wire Lead

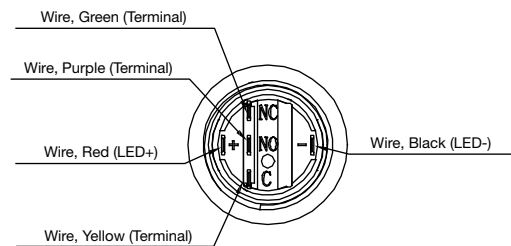
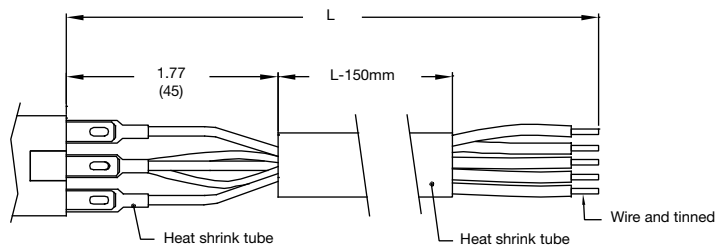

Hardware - Dimensions inches (mm)

Hex Nut Order PN: ATP19-HN

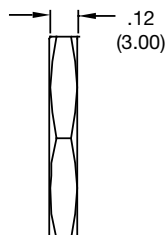
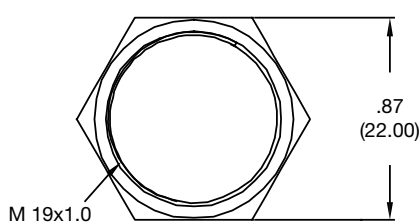

O Ring Order PN: ATP19-OR

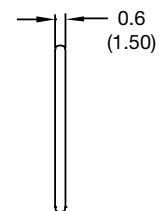
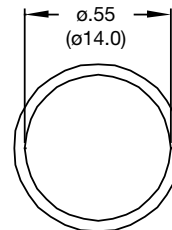

Disclaimer Notice - Information furnished is believed to be accurate and reliable. However, users should independently evaluate the suitability of and test each product selected for their own applications. Littelfuse products are not designed for, and may not be used in, all applications. Read complete Disclaimer Notice at <http://www.littelfuse.com/disclaimer-electronics>.

Looking for pricing, stock, or lifecycle information?

Click below to explore more details on WIN SOURCE:

- ⊖ [View ATP19-SL1-324-B0SE-03Q on WIN SOURCE](#)
- ⊖ [C&K Components Information](#)

Optimize Your Supply Chain with WIN SOURCE Solutions

- ✓ Global Sourcing Solution
- ✓ Obsolete Management
- ✓ Cost Control Management
- ✓ Shortage Management
- ✓ Alternative Solution
- ✓ Excess Inventory Management