



**THE DATASHEET OF
RCER71H473K0M1H03A**



Reference Specification

Leaded MLCC for Automotive (Powertrain/Safety)
RCE Series

Product specifications in this catalog are as of Apr. 2024, and are subject to change or obsolescence without notice.
Please consult the approval sheet before ordering. Please read rating and Cautions first.

<Reference> Please kindly use our website.

Please refer to the product information page for more information on ceramic capacitors. → [Ceramic capacitor product information](#)

Various data can be obtained directly from the product search. → [Product search \(SMD\)](#) / [Product search \(Lead Type\)](#)

⚠ CAUTION**1. OPERATING VOLTAGE**

Do not apply a voltage to the capacitor that exceeds the rated voltage as called out in the specifications.

1-1. Applied voltage between the terminals of a capacitor shall be less than or equal to the rated voltage.

(1) When AC voltage is superimposed on DC voltage, the zero-to-peak voltage shall not exceed the rated DC voltage. When AC voltage or pulse voltage is applied, the peak-to-peak voltage shall not exceed the rated DC voltage.

(2) Abnormal voltages (surge voltage, static electricity, pulse voltage, etc.) shall not exceed the rated DC voltage.

Typical Voltage Applied to the DC Capacitor

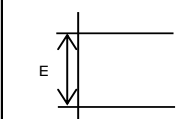
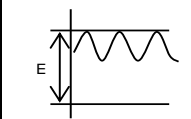
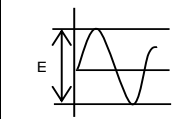
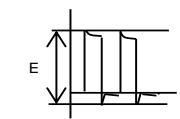
DC Voltage	DC+AC Voltage	AC Voltage	Pulse Voltage
			

(E: Maximum possible applied voltage.)

1-2. Influence of over voltage

Over voltage that is applied to the capacitor may result in an electrical short circuit caused by the breakdown of the internal dielectric layers. The time duration until breakdown depends on the applied voltage and the ambient temperature.

Use a safety standard certified capacitor in a power supply input circuit (AC filter), as it is also necessary to consider the withstand voltage and impulse withstand voltage defined for each device.

2. OPERATING TEMPERATURE AND SELF-GENERATED HEAT

Keep the surface temperature of a capacitor below the upper limit of its rated operating temperature range. Be sure to take into account the heat generated by the capacitor itself.

When the capacitor is used in a high-frequency current, pulse current or the like, it may have the self-generated heat due to dielectric-loss. In case of Class 2 capacitors (Temp.Char.: X7R,X7S,X8L, etc.), applied voltage should be the load such as self-generated heat is within 20 °C on the condition of atmosphere temperature 25 °C.

Since the self-heating is low in the Class 1 capacitors (Temp.Char.: C0G,U2J,X8G, etc.), the allowable power becomes extremely high compared to the Class 2 capacitors.

However, when a load with self-heating of 20°C is applied at the rated voltage, the allowable power may be exceeded. Please confirm that there is no rising trend of the capacitor's surface temperature and that the surface temperature of the capacitor does not exceed the maximum operating temperature.

Excessive generation of heat may cause deterioration of the characteristics and reliability of the capacitor.

When measuring the self-heating temperature, be aware that accurate measurement may not be possible due to the following effects.

- The heat generated by other parts
- Air flow such as convection and cooling fans
- Temperature sensor used for measuring surface temperature of capacitor

In the case using a thermocouple, it is recommended that use a K thermocouple of $\Phi 0.1\text{mm}$ with less heat capacity.

3. FAIL-SAFE

Capacitors that are cracked by dropping or bending of the board may cause deterioration of the insulation resistance, and result in a short.

If the circuit being used may cause an electrical shock, smoke or fire when a capacitor is shorted, be sure to install fail-safe functions, such as a fuse, to prevent secondary accidents.

4. OPERATING AND STORAGE ENVIRONMENT

The insulating coating of capacitors does not form a perfect seal; therefore, do not use or store capacitors in a corrosive atmosphere, especially where chloride gas, sulfide gas, acid, alkali, salt or the like are present. And avoid exposure to moisture. Before cleaning, bonding, or molding this product, verify that these processes do not affect product quality by testing the performance of a cleaned, bonded or molded product in the intended equipment. Store the capacitors where the temperature and relative humidity do not exceed 5 to 40 °C and 20 to 70%. Use capacitors within 6 months.

Use capacitors within 6 months after delivered. Check the solderability after 6 months or more.

Due to moisture condensation caused by rapid humidity changes, or the photochemical change caused by direct sunlight on the terminal electrodes, the solderability and electrical performance may deteriorate. Do not store capacitors under direct sunlight or in high humidity conditions.

5. VIBRATION AND IMPACT

Do not expose a capacitor or its leads to excessive shock or vibration during use.

5-1. Mechanical shock due to being dropped may cause damage or a crack in the dielectric material of the capacitor.

Do not use a dropped capacitor because the quality and reliability may be deteriorated.

5-2. Excessive shock or vibration may cause to fatigue destruction of lead wires mounted on the circuit board. If necessary, take measures to hold a capacitor on the circuit boards by adhesive, molding resin or coating and other.

Please confirm there is no influence of holding measures on the product with an intended equipment.

6. SOLDERING

When soldering this product to a PCB/PWB, do not exceed the solder heat resistance specification of the capacitor. Subjecting this product to excessive heating could melt the internal junction solder and may result in thermal shocks that can crack the ceramic element.

Please verify that the soldering process does not affect the quality of capacitors.

6-1. Flow Soldering

Soldering temperature	: 260 °C max.
Soldering time	: 7.5 s max.
Preheating temperature	: 120 °C max.
Preheating time	: 60 s max.

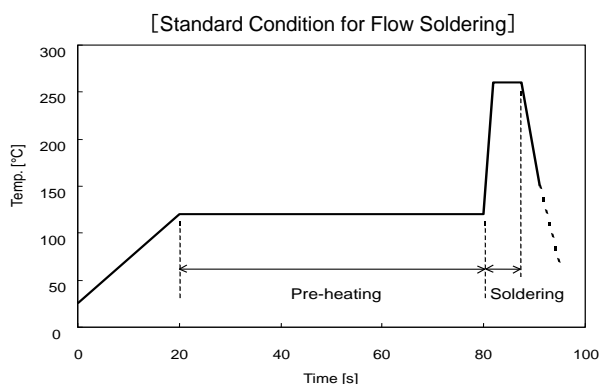

6-2. Reflow Soldering

Do not apply reflow soldering.

6-3. Soldering Iron

Temperature of iron-tip	: 350 °C max.
Soldering iron wattage	: 60 W max.
Soldering time	: 3.5 s max.

7. BONDING AND RESIN MOLDING, RESIN COAT

In case of bonding, molding or coating this product, verify that these processes do not affect the quality of capacitor by testing the performance of a bonded or molded product in the intended equipment.

In case of the amount of applications, dryness / hardening conditions of adhesives and molding resins containing organic solvents (ethyl acetate, methyl ethyl ketone, toluene, etc.) are unsuitable, the outer coating resin of a capacitor is damaged by the organic solvents and it may result, worst case, in a short circuit.

The variation in thickness of adhesive or molding resin may cause a outer coating resin cracking and/or ceramic element cracking of a capacitor in a temperature cycling.

8. TREATMENT AFTER BONDING AND RESIN MOLDING, RESIN COAT

When the outer coating is hot (over 100 °C) after soldering, it becomes soft and fragile.

So please be careful not to give it mechanical stress.

Failure to follow the above cautions may result, worst case, in a short circuit and cause fuming or partial dispersion when the product is used.

9. LIMITATION OF APPLICATIONS

The products listed in the specification(hereinafter the product(s) is called as the "Product(s)") are designed and manufactured for applications specified in the specification. (hereinafter called as the "Specific Application")

We shall not warrant anything in connection with the Products including fitness, performance, adequateness, safety, or quality, in the case of applications listed in from (1) to (11) written at the end of this precautions, which may generally require high performance, function, quality, management of production or safety.

Therefore, the Product shall be applied in compliance with the specific application.

WE DISCLAIM ANY LOSS AND DAMAGES ARISING FROM OR IN CONNECTION WITH THE PRODUCTS INCLUDING BUT NOT LIMITED TO THE CASE SUCH LOSS AND DAMAGES CAUSED BY THE UNEXPECTED ACCIDENT, IN EVENT THAT (i) THE PRODUCT IS APPLIED FOR THE PURPOSE WHICH IS NOT SPECIFIED AS THE SPECIFIC APPLICATION FOR THE PRODUCT, AND/OR (ii) THE PRODUCT IS APPLIED FOR ANY FOLLOWING APPLICATION PURPOSES FROM (1) TO (11) (EXCEPT THAT SUCH APPLICATION PURPOSE IS UNAMBIGUOUSLY SPECIFIED AS SPECIFIC APPLICATION FOR THE PRODUCT IN OUR CATALOG SPECIFICATION FORMS, DATASHEETS, OR OTHER DOCUMENTS OFFICIALLY ISSUED BY US*)

1. Aircraft equipment
2. Aerospace equipment
3. Undersea equipment
4. Power plant control equipment
5. Medical equipment
6. Transportation equipment
7. Traffic control equipment
8. Disaster prevention/security equipment
9. Industrial data-processing equipment
10. Combustion/explosion control equipment
11. Equipment with complexity and/or required reliability equivalent to the applications listed in the above.

For exploring information of the Products which will be compatible with the particular purpose other than those specified in the specification, please contact our sales offices, distribution agents, or trading companies with which you make a deal, or via our web contact form.

Contact form: <https://www.murata.com/contactform>

*We may design and manufacture particular Products for applications listed in (1) to (11). Provided that, in such case we shall unambiguously specify such Specific Application in the specification without any exception.

Therefore, any other documents and/or performances, whether exist or non-exist, shall not be deemed as the evidence to imply that we accept the applications listed in (1) to (11).

NOTICE**1. CLEANING**

- 1-1. Please evaluate the capacitor using actual cleaning equipment and conditions to confirm the quality, and select the solvent for cleaning.
- 1-2. Unsuitable cleaning may leave residual flux or other foreign substances, causing deterioration of electrical characteristics and the reliability of the capacitors.
- 1-3. To perform ultrasonic cleaning, observe the following conditions.
 - Rinse bath capacity : Output of 20 watts per liter or less.
 - Rinsing time : 5 min maximum.
 - Do not vibrate the PCB/PWB directly.
 - Excessive ultrasonic cleaning may lead to fatigue destruction of the lead wires.

2. SOLDERING AND MOUNTING

- 2-1. Insert the lead wire into the PCB with a distance appropriate to the lead space.
If the lead wires are inserted into different spacing holes, cracks may occur in the outer resin or the internal element.
- 2-2. When bending the lead wire, excessive force applied to the capacitor body may cause cracks in the outer resin or the internal element. Hold the lead wire closer to the capacitor body than the lead wire bending position with the fixture, then bend it.

(See the right figure)

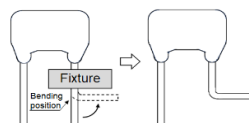

- 2-3. When cutting and clinching the lead wire, do not apply excessive force to the capacitor body.
- 2-4. When soldering, insert the lead wire into the PCB without mechanically stressing the lead wire.

3. CAPACITANCE CHANGE OF CAPACITORS

- Class 2 capacitors (Temp.Char. : X7R,X7S,X8L etc.)
Class 2 capacitors an aging characteristic, whereby the capacitor continually decreases its capacitance slightly if the capacitor leaves for a long time. Moreover, capacitance might change greatly depending on a surrounding temperature or an applied voltage. So, it is not likely to be able to use for the time constant circuit.
Please contact us if you need a detail information.

4. CHARACTERISTICS EVALUATION IN THE ACTUAL SYSTEM

- 4-1. Evaluate the capacitor in the actual system, to confirm that there is no problem with the performance and specification values in a finished product before using.
- 4-2. Since a voltage dependency and temperature dependency exists in the capacitance of Class 2 ceramic capacitors, the capacitance may change depending on the operating conditions in the actual system. Therefore, be sure to evaluate the various characteristics, such as the leakage current and noise absorptivity, which will affect the capacitance value of the capacitor.
- 4-3. In addition, voltages exceeding the predetermined surge may be applied to the capacitor by the inductance in the actual system.
Evaluate the surge resistance in the actual system as required.
- 4-4. When using Class 2 ceramic capacitors in AC or pulse circuits, the capacitor itself vibrates at specific frequencies and noise may be generated. Moreover, when the mechanical vibration or shock is added to capacitor, noise may occur.

⚠ NOTE

1. Please make sure that your product has been evaluated in view of your specifications with our product being mounted to your product.
2. You are requested not to use our product deviating from this product specification.

1. Application

This product specification is applied to Leaded MLCC RCE series.

1. Specific applications:

- Automotive powertrain/safety equipment: Products that can be used for automotive equipment related to running, turning, stopping, safety devices, etc., or equipment whose structure, equipment, and performance are legally required to meet technical standards for safety assurance or environmental protection.
- Automotive infotainment/comfort equipment: Products that can be used for automotive equipment such as car navigation systems and car audio systems that do not directly relate to human life and whose structure, equipment, and performance are not specifically required by law to meet technical standards for safety assurance or environmental protection.
- Medial Equipment [GHTF A/B/C] except for Implant Equipment: Products suitable for use in medical devices designated under the GHTF international classifications as Class A or Class B (the functions of which are not directly involved in protection of human life or property) or in medical devices other than implants designated under the GHTF international classifications as Class C (the malfunctioning of which is considered to pose a comparatively high risk to the human body).

2.Unsuitable Application: Applications listed in "Limitation of applications" in this product specification.

2. Rating

• Part Number Configuration

ex.)	RCE	C7	1H	226	M	W	K1	H03	B
	Series	Temperature Characteristics	Rated Voltage	Capacitance	Capacitance Tolerance	Dimension (LxW)	Lead Style	Individual Specification	Package

• Temperature Characteristics

Code	Temp. Char.	Temp. Range	Cap. Change	Standard Temp.	Operating Temp. Range
C7	X7S (EIA code)	-55~125°C	+/-22%	25°C	-55~125°C
R7	X7R (EIA code)	-55~125°C	+/-15%	25°C	-55~125°C

• Rated Voltage

Code	Rated voltage
1E	DC25V
1H	DC50V
2A	DC100V

• Capacitance

The first two digits denote significant figures ; the last digit denotes the multiplier of 10 in pF.

ex.) In case of 226 .

$$22 \times 10^6 = 22000000 \text{ pF}$$

• Capacitance Tolerance

Code	Capacitance Tolerance
K	+/-10%
M	+/-20%

Reference only

- Dimension (LxW)
Please refer to [Part number list].

- Lead Style
*Lead wire is "solder coated CP wire".

Code	Lead Style	Lead spacing (mm)
A2	Straight type	2.5+/-0.8
A3	Straight type	2.5+/-0.8
DB	Straight taping type	2.5+0.4/-0.2
DN	Straight taping type	2.5+0.4/-0.2
K1	Inside crimp type	5.0+/-0.8
M1	Inside crimp taping type	5.0+0.6/-0.2

- Individual Specification
Murata's control code.
Please refer to [Part number list].







- Package

Code	Package
A	Taping type of Ammo
B	Bulk type

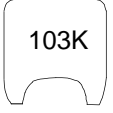
3. Marking

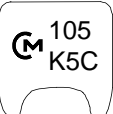
- Temp. char. : Letter code : C (X7R/X7S Char. Except dimension code : 0,1)
- Capacitance : 3 digit numbers
- Capacitance tolerance : Code
- Rated voltage : Letter code : 2 (DC25V. Except dimension code : 0,1)
Letter code : 5 (DC50V. Except dimension code : 0,1)
Letter code : 1 (DC100V. Except dimension code : 0,1)
- Company name code : Abbreviation :  (Except dimension code : 0,1)

(Ex.)

Rated voltage / Dimension code	DC25V	DC50V	DC100V
0,1			
2			
3,W			

4. Part number list

• Straight Long
(Lead Style:A2)

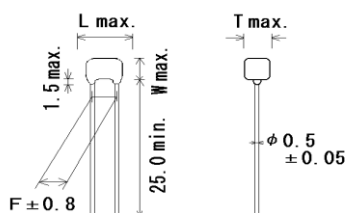

Unit : mm

Customer Part Number	Murata Part Number	T.C.	DC Rated Volt. (V)	Cap.	Cap. Tol.	Dimension (mm)					Dimension (LxW) Lead Style	Pack qty. (pcs)
						L	W	W1	F	T		
	RCER71E104K0A2H03B	X7R	25	0.1 μ F	\pm 10%	3.6	3.5	-	2.5	2.5	0A2	500
	RCER71E154K0A2H03B	X7R	25	0.15 μ F	\pm 10%	3.6	3.5	-	2.5	2.5	0A2	500
	RCER71E224K0A2H03B	X7R	25	0.22 μ F	\pm 10%	3.6	3.5	-	2.5	2.5	0A2	500
	RCER71E334K1A2H03B	X7R	25	0.33 μ F	\pm 10%	4.0	3.5	-	2.5	2.5	1A2	500
	RCER71E474K1A2H03B	X7R	25	0.47 μ F	\pm 10%	4.0	3.5	-	2.5	2.5	1A2	500
	RCER71E684K1A2H03B	X7R	25	0.68 μ F	\pm 10%	4.0	3.5	-	2.5	2.5	1A2	500
	RCER71E105K1A2H03B	X7R	25	1.0 μ F	\pm 10%	4.0	3.5	-	2.5	2.5	1A2	500
	RCER71E155K2A2H03B	X7R	25	1.5 μ F	\pm 10%	5.5	4.0	-	2.5	3.15	2A2	500
	RCER71E225K2A2H03B	X7R	25	2.2 μ F	\pm 10%	5.5	4.0	-	2.5	3.15	2A2	500
	RCER71E335K2A2H03B	X7R	25	3.3 μ F	\pm 10%	5.5	4.0	-	2.5	3.15	2A2	500
	RCER71E475K2A2H03B	X7R	25	4.7 μ F	\pm 10%	5.5	4.0	-	2.5	3.15	2A2	500
	RCER71E106K3A2H03B	X7R	25	10 μ F	\pm 10%	5.5	5.0	-	2.5	4.0	3A2	500
	RCER71H221K0A2H03B	X7R	50	220pF	\pm 10%	3.6	3.5	-	2.5	2.5	0A2	500
	RCER71H331K0A2H03B	X7R	50	330pF	\pm 10%	3.6	3.5	-	2.5	2.5	0A2	500
	RCER71H471K0A2H03B	X7R	50	470pF	\pm 10%	3.6	3.5	-	2.5	2.5	0A2	500
	RCER71H681K0A2H03B	X7R	50	680pF	\pm 10%	3.6	3.5	-	2.5	2.5	0A2	500
	RCER71H102K0A2H03B	X7R	50	1000pF	\pm 10%	3.6	3.5	-	2.5	2.5	0A2	500
	RCER71H152K0A2H03B	X7R	50	1500pF	\pm 10%	3.6	3.5	-	2.5	2.5	0A2	500
	RCER71H222K0A2H03B	X7R	50	2200pF	\pm 10%	3.6	3.5	-	2.5	2.5	0A2	500
	RCER71H332K0A2H03B	X7R	50	3300pF	\pm 10%	3.6	3.5	-	2.5	2.5	0A2	500
	RCER71H472K0A2H03B	X7R	50	4700pF	\pm 10%	3.6	3.5	-	2.5	2.5	0A2	500
	RCER71H682K0A2H03B	X7R	50	6800pF	\pm 10%	3.6	3.5	-	2.5	2.5	0A2	500
	RCER71H103K0A2H03B	X7R	50	10000pF	\pm 10%	3.6	3.5	-	2.5	2.5	0A2	500
	RCER71H153K0A2H03B	X7R	50	15000pF	\pm 10%	3.6	3.5	-	2.5	2.5	0A2	500
	RCER71H223K0A2H03B	X7R	50	22000pF	\pm 10%	3.6	3.5	-	2.5	2.5	0A2	500
	RCER71H333K0A2H03B	X7R	50	33000pF	\pm 10%	3.6	3.5	-	2.5	2.5	0A2	500
	RCER71H473K0A2H03B	X7R	50	47000pF	\pm 10%	3.6	3.5	-	2.5	2.5	0A2	500
	RCER71H683K0A2H03B	X7R	50	68000pF	\pm 10%	3.6	3.5	-	2.5	2.5	0A2	500
	RCER71H104K0A2H03B	X7R	50	0.1 μ F	\pm 10%	3.6	3.5	-	2.5	2.5	0A2	500
	RCER71H154K1A2H03B	X7R	50	0.15 μ F	\pm 10%	4.0	3.5	-	2.5	2.5	1A2	500
	RCER71H224K1A2H03B	X7R	50	0.22 μ F	\pm 10%	4.0	3.5	-	2.5	2.5	1A2	500
	RCER71H334K1A2H03B	X7R	50	0.33 μ F	\pm 10%	4.0	3.5	-	2.5	2.5	1A2	500
	RCER71H474K1A2H03B	X7R	50	0.47 μ F	\pm 10%	4.0	3.5	-	2.5	2.5	1A2	500
	RCER71H684K2A2H03B	X7R	50	0.68 μ F	\pm 10%	5.5	4.0	-	2.5	3.15	2A2	500
	RCEC71H105K1A2H03B	X7S	50	1.0 μ F	\pm 10%	4.0	3.5	-	2.5	2.5	1A2	500
	RCER71H105K2A2H03B	X7R	50	1.0 μ F	\pm 10%	5.5	4.0	-	2.5	3.15	2A2	500
	RCER71H155K2A2H03B	X7R	50	1.5 μ F	\pm 10%	5.5	4.0	-	2.5	3.15	2A2	500
	RCER71H225K2A2H03B	X7R	50	2.2 μ F	\pm 10%	5.5	4.0	-	2.5	3.15	2A2	500
	RCER71H335K3A2H03B	X7R	50	3.3 μ F	\pm 10%	5.5	5.0	-	2.5	4.0	3A2	500
	RCEC71H475K2A2H03B	X7S	50	4.7 μ F	\pm 10%	5.5	4.0	-	2.5	3.15	2A2	500

- Straight Long
(Lead Style:A2)

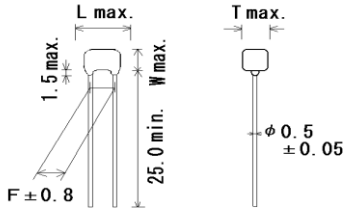

- Straight Long
(Lead Style:A3)

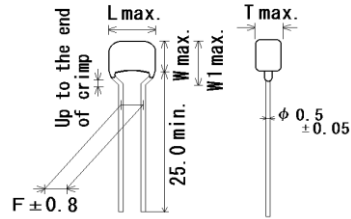

Unit : mm

Customer Part Number	Murata Part Number	T.C.	DC Rated Volt. (V)	Cap.	Cap. Tol.	Dimension (mm)					Dimension (LxW) Lead Style	Pack qty. (pcs)
						L	W	W1	F	T		
	RCER71H475K3A2H03B	X7R	50	4.7μF	±10%	5.5	5.0	-	2.5	4.0	3A2	500
	RCEC71H106K3A2H03B	X7S	50	10μF	±10%	5.5	5.0	-	2.5	4.0	3A2	500
	RCER72A221K0A2H03B	X7R	100	220pF	±10%	3.6	3.5	-	2.5	2.5	0A2	500
	RCER72A331K0A2H03B	X7R	100	330pF	±10%	3.6	3.5	-	2.5	2.5	0A2	500
	RCER72A471K0A2H03B	X7R	100	470pF	±10%	3.6	3.5	-	2.5	2.5	0A2	500
	RCER72A681K0A2H03B	X7R	100	680pF	±10%	3.6	3.5	-	2.5	2.5	0A2	500
	RCER72A102K0A2H03B	X7R	100	1000pF	±10%	3.6	3.5	-	2.5	2.5	0A2	500
	RCER72A152K0A2H03B	X7R	100	1500pF	±10%	3.6	3.5	-	2.5	2.5	0A2	500
	RCER72A222K0A2H03B	X7R	100	2200pF	±10%	3.6	3.5	-	2.5	2.5	0A2	500
	RCER72A332K0A2H03B	X7R	100	3300pF	±10%	3.6	3.5	-	2.5	2.5	0A2	500
	RCER72A472K0A2H03B	X7R	100	4700pF	±10%	3.6	3.5	-	2.5	2.5	0A2	500
	RCER72A682K0A2H03B	X7R	100	6800pF	±10%	3.6	3.5	-	2.5	2.5	0A2	500
	RCER72A103K0A2H03B	X7R	100	10000pF	±10%	3.6	3.5	-	2.5	2.5	0A2	500
	RCER72A153K0A2H03B	X7R	100	15000pF	±10%	3.6	3.5	-	2.5	2.5	0A2	500
	RCER72A223K0A2H03B	X7R	100	22000pF	±10%	3.6	3.5	-	2.5	2.5	0A2	500
	RCER72A333K1A2H03B	X7R	100	33000pF	±10%	4.0	3.5	-	2.5	2.5	1A2	500
	RCER72A473K1A2H03B	X7R	100	47000pF	±10%	4.0	3.5	-	2.5	2.5	1A2	500
	RCER72A683K1A2H03B	X7R	100	68000pF	±10%	4.0	3.5	-	2.5	2.5	1A2	500
	RCER72A104K1A2H03B	X7R	100	0.1μF	±10%	4.0	3.5	-	2.5	2.5	1A2	500
	RCER72A154K2A2H03B	X7R	100	0.15μF	±10%	5.5	4.0	-	2.5	3.15	2A2	500
	RCER72A224K2A2H03B	X7R	100	0.22μF	±10%	5.5	4.0	-	2.5	3.15	2A2	500
	RCER72A334K1A2H03B	X7R	100	0.33μF	±10%	4.0	3.5	-	2.5	2.5	1A2	500
	RCER72A474K2A2H03B	X7R	100	0.47μF	±10%	5.5	4.0	-	2.5	3.15	2A2	500
	RCER72A684K2A2H03B	X7R	100	0.68μF	±10%	5.5	4.0	-	2.5	3.15	2A2	500
	RCEC72A105K1A2H03B	X7S	100	1.0μF	±10%	4.0	3.5	-	2.5	2.5	1A2	500
	RCER72A105K2A2H03B	X7R	100	1.0μF	±10%	5.5	4.0	-	2.5	3.15	2A2	500
	RCEC72A155K3A2H03B	X7S	100	1.5μF	±10%	5.5	5.0	-	2.5	4.0	3A2	500
	RCEC72A225K2A3H03B	X7S	100	2.2μF	±10%	5.5	4.0	6.0	2.5	3.15	2A3	500
	RCEC72A225K3A2H03B	X7S	100	2.2μF	±10%	5.5	5.0	-	2.5	4.0	3A2	500
	RCEC72A475K3A3H03B	X7S	100	4.7μF	±10%	5.5	5.0	7.5	2.5	4.0	3A3	500

- Inside Crimp
(Lead Style : K*)

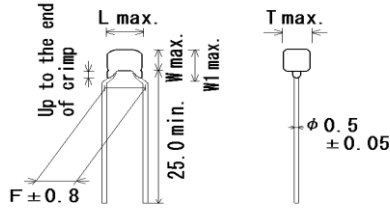

Unit : mm

Customer Part Number	Murata Part Number	T.C.	DC Rated Volt. (V)	Cap.	Cap. Tol.	Dimension (mm)					Dimension (LxW) Lead Style	Pack qty. (pcs)
						L	W	W1	F	T		
	RCER71E104K0K1H03B	X7R	25	0.1 μ F	\pm 10%	3.6	3.5	6.0	5.0	2.5	0K1	500
	RCER71E154K0K1H03B	X7R	25	0.15 μ F	\pm 10%	3.6	3.5	6.0	5.0	2.5	0K1	500
	RCER71E224K0K1H03B	X7R	25	0.22 μ F	\pm 10%	3.6	3.5	6.0	5.0	2.5	0K1	500
	RCER71E334K1K1H03B	X7R	25	0.33 μ F	\pm 10%	4.0	3.5	5.0	5.0	2.5	1K1	500
	RCER71E474K1K1H03B	X7R	25	0.47 μ F	\pm 10%	4.0	3.5	5.0	5.0	2.5	1K1	500
	RCER71E684K1K1H03B	X7R	25	0.68 μ F	\pm 10%	4.0	3.5	5.0	5.0	2.5	1K1	500
	RCER71E105K1K1H03B	X7R	25	1.0 μ F	\pm 10%	4.0	3.5	5.0	5.0	2.5	1K1	500
	RCER71E155K2K1H03B	X7R	25	1.5 μ F	\pm 10%	5.5	4.0	6.0	5.0	3.15	2K1	500
	RCER71E225K2K1H03B	X7R	25	2.2 μ F	\pm 10%	5.5	4.0	6.0	5.0	3.15	2K1	500
	RCER71E335K2K1H03B	X7R	25	3.3 μ F	\pm 10%	5.5	4.0	6.0	5.0	3.15	2K1	500
	RCER71E475K2K1H03B	X7R	25	4.7 μ F	\pm 10%	5.5	4.0	6.0	5.0	3.15	2K1	500
	RCER71E106K3K1H03B	X7R	25	10 μ F	\pm 10%	5.5	5.0	7.5	5.0	4.0	3K1	500
	RCER71E226MVK1H03B	X7R	25	22 μ F	\pm 20%	5.5	7.5	10.0	5.0	4.0	WK1	500
	RCER71H221K0K1H03B	X7R	50	220pF	\pm 10%	3.6	3.5	6.0	5.0	2.5	0K1	500
	RCER71H331K0K1H03B	X7R	50	330pF	\pm 10%	3.6	3.5	6.0	5.0	2.5	0K1	500
	RCER71H471K0K1H03B	X7R	50	470pF	\pm 10%	3.6	3.5	6.0	5.0	2.5	0K1	500
	RCER71H681K0K1H03B	X7R	50	680pF	\pm 10%	3.6	3.5	6.0	5.0	2.5	0K1	500
	RCER71H102K0K1H03B	X7R	50	1000pF	\pm 10%	3.6	3.5	6.0	5.0	2.5	0K1	500
	RCER71H152K0K1H03B	X7R	50	1500pF	\pm 10%	3.6	3.5	6.0	5.0	2.5	0K1	500
	RCER71H222K0K1H03B	X7R	50	2200pF	\pm 10%	3.6	3.5	6.0	5.0	2.5	0K1	500
	RCER71H332K0K1H03B	X7R	50	3300pF	\pm 10%	3.6	3.5	6.0	5.0	2.5	0K1	500
	RCER71H472K0K1H03B	X7R	50	4700pF	\pm 10%	3.6	3.5	6.0	5.0	2.5	0K1	500
	RCER71H682K0K1H03B	X7R	50	6800pF	\pm 10%	3.6	3.5	6.0	5.0	2.5	0K1	500
	RCER71H103K0K1H03B	X7R	50	10000pF	\pm 10%	3.6	3.5	6.0	5.0	2.5	0K1	500
	RCER71H153K0K1H03B	X7R	50	15000pF	\pm 10%	3.6	3.5	6.0	5.0	2.5	0K1	500
	RCER71H223K0K1H03B	X7R	50	22000pF	\pm 10%	3.6	3.5	6.0	5.0	2.5	0K1	500
	RCER71H333K0K1H03B	X7R	50	33000pF	\pm 10%	3.6	3.5	6.0	5.0	2.5	0K1	500
	RCER71H473K0K1H03B	X7R	50	47000pF	\pm 10%	3.6	3.5	6.0	5.0	2.5	0K1	500
	RCER71H683K0K1H03B	X7R	50	68000pF	\pm 10%	3.6	3.5	6.0	5.0	2.5	0K1	500
	RCER71H104K0K1H03B	X7R	50	0.1 μ F	\pm 10%	3.6	3.5	6.0	5.0	2.5	0K1	500
	RCER71H154K1K1H03B	X7R	50	0.15 μ F	\pm 10%	4.0	3.5	5.0	5.0	2.5	1K1	500
	RCER71H224K1K1H03B	X7R	50	0.22 μ F	\pm 10%	4.0	3.5	5.0	5.0	2.5	1K1	500
	RCER71H334K1K1H03B	X7R	50	0.33 μ F	\pm 10%	4.0	3.5	5.0	5.0	2.5	1K1	500
	RCER71H474K1K1H03B	X7R	50	0.47 μ F	\pm 10%	4.0	3.5	5.0	5.0	2.5	1K1	500
	RCER71H684K2K1H03B	X7R	50	0.68 μ F	\pm 10%	5.5	4.0	6.0	5.0	3.15	2K1	500
	RCEC71H105K1K1H03B	X7S	50	1.0 μ F	\pm 10%	4.0	3.5	5.0	5.0	2.5	1K1	500
	RCER71H105K2K1H03B	X7R	50	1.0 μ F	\pm 10%	5.5	4.0	6.0	5.0	3.15	2K1	500
	RCER71H155K2K1H03B	X7R	50	1.5 μ F	\pm 10%	5.5	4.0	6.0	5.0	3.15	2K1	500
	RCER71H225K2K1H03B	X7R	50	2.2 μ F	\pm 10%	5.5	4.0	6.0	5.0	3.15	2K1	500
	RCER71H335K3K1H03B	X7R	50	3.3 μ F	\pm 10%	5.5	5.0	7.5	5.0	4.0	3K1	500

- Inside Crimp
(Lead Style:K*)

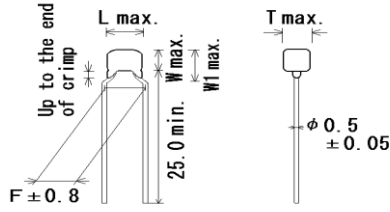

Unit : mm

Customer Part Number	Murata Part Number	T.C.	DC Rated Volt. (V)	Cap.	Cap. Tol.	Dimension (mm)					Dimension (LxW) Lead Style	Pack qty. (pcs)
						L	W	W1	F	T		
	RCEC71H475K2K1H03B	X7S	50	4.7μF	±10%	5.5	4.0	6.0	5.0	3.15	2K1	500
	RCER71H475K3K1H03B	X7R	50	4.7μF	±10%	5.5	5.0	7.5	5.0	4.0	3K1	500
	RCEC71H106K3K1H03B	X7S	50	10μF	±10%	5.5	5.0	7.5	5.0	4.0	3K1	500
	RCER71H106MVK1H03B	X7R	50	10μF	±20%	5.5	7.5	10.0	5.0	4.0	WK1	500
	RCEC71H226MVK1H03B	X7S	50	22μF	±20%	5.5	7.5	10.0	5.0	4.0	WK1	500
	RCER72A221K0K1H03B	X7R	100	220pF	±10%	3.6	3.5	6.0	5.0	2.5	0K1	500
	RCER72A331K0K1H03B	X7R	100	330pF	±10%	3.6	3.5	6.0	5.0	2.5	0K1	500
	RCER72A471K0K1H03B	X7R	100	470pF	±10%	3.6	3.5	6.0	5.0	2.5	0K1	500
	RCER72A681K0K1H03B	X7R	100	680pF	±10%	3.6	3.5	6.0	5.0	2.5	0K1	500
	RCER72A102K0K1H03B	X7R	100	1000pF	±10%	3.6	3.5	6.0	5.0	2.5	0K1	500
	RCER72A152K0K1H03B	X7R	100	1500pF	±10%	3.6	3.5	6.0	5.0	2.5	0K1	500
	RCER72A222K0K1H03B	X7R	100	2200pF	±10%	3.6	3.5	6.0	5.0	2.5	0K1	500
	RCER72A332K0K1H03B	X7R	100	3300pF	±10%	3.6	3.5	6.0	5.0	2.5	0K1	500
	RCER72A472K0K1H03B	X7R	100	4700pF	±10%	3.6	3.5	6.0	5.0	2.5	0K1	500
	RCER72A682K0K1H03B	X7R	100	6800pF	±10%	3.6	3.5	6.0	5.0	2.5	0K1	500
	RCER72A103K0K1H03B	X7R	100	10000pF	±10%	3.6	3.5	6.0	5.0	2.5	0K1	500
	RCER72A153K0K1H03B	X7R	100	15000pF	±10%	3.6	3.5	6.0	5.0	2.5	0K1	500
	RCER72A223K0K1H03B	X7R	100	22000pF	±10%	3.6	3.5	6.0	5.0	2.5	0K1	500
	RCER72A333K1K1H03B	X7R	100	33000pF	±10%	4.0	3.5	5.0	5.0	2.5	1K1	500
	RCER72A473K1K1H03B	X7R	100	47000pF	±10%	4.0	3.5	5.0	5.0	2.5	1K1	500
	RCER72A683K1K1H03B	X7R	100	68000pF	±10%	4.0	3.5	5.0	5.0	2.5	1K1	500
	RCER72A104K1K1H03B	X7R	100	0.1μF	±10%	4.0	3.5	5.0	5.0	2.5	1K1	500
	RCER72A154K2K1H03B	X7R	100	0.15μF	±10%	5.5	4.0	6.0	5.0	3.15	2K1	500
	RCER72A224K2K1H03B	X7R	100	0.22μF	±10%	5.5	4.0	6.0	5.0	3.15	2K1	500
	RCER72A334K1K1H03B	X7R	100	0.33μF	±10%	4.0	3.5	5.0	5.0	2.5	1K1	500
	RCER72A474K2K1H03B	X7R	100	0.47μF	±10%	5.5	4.0	6.0	5.0	3.15	2K1	500
	RCER72A684K2K1H03B	X7R	100	0.68μF	±10%	5.5	4.0	6.0	5.0	3.15	2K1	500
	RCEC72A105K1K1H03B	X7S	100	1.0μF	±10%	4.0	3.5	5.0	5.0	2.5	1K1	500
	RCER72A105K2K1H03B	X7R	100	1.0μF	±10%	5.5	4.0	6.0	5.0	3.15	2K1	500
	RCEC72A155K3K1H03B	X7S	100	1.5μF	±10%	5.5	5.0	7.5	5.0	4.0	3K1	500
	RCEC72A225K2K1H03B	X7S	100	2.2μF	±10%	5.5	4.0	6.0	5.0	3.15	2K1	500
	RCEC72A225K3K1H03B	X7S	100	2.2μF	±10%	5.5	5.0	7.5	5.0	4.0	3K1	500
	RCEC72A475K3K1H03B	X7S	100	4.7μF	±10%	5.5	5.0	7.5	5.0	4.0	3K1	500
	RCEC72A475MVK1H03B	X7S	100	4.7μF	±20%	5.5	7.5	10.0	5.0	4.0	WK1	500

• Straight Taping
(Lead Style :DB)

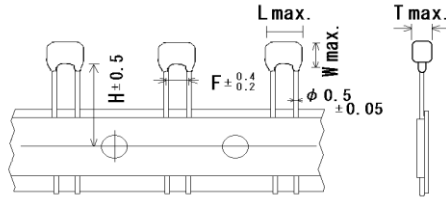

Unit : mm

Customer Part Number	Murata Part Number	T.C.	DC Rated Volt. (V)	Cap.	Cap. Tol.	Dimension (mm)						Dimension (LxW) Lead Style	Pack qty. (pcs)
						L	W	W1	F	T	H/H0		
	RCER71E104K0DBH03A	X7R	25	0.1μF	±10%	3.6	3.5	-	2.5	2.5	16.0	0DB	2000
	RCER71E154K0DBH03A	X7R	25	0.15μF	±10%	3.6	3.5	-	2.5	2.5	16.0	0DB	2000
	RCER71E224K0DBH03A	X7R	25	0.22μF	±10%	3.6	3.5	-	2.5	2.5	16.0	0DB	2000
	RCER71E334K1DBH03A	X7R	25	0.33μF	±10%	4.0	3.5	-	2.5	2.5	16.0	1DB	2000
	RCER71E474K1DBH03A	X7R	25	0.47μF	±10%	4.0	3.5	-	2.5	2.5	16.0	1DB	2000
	RCER71E684K1DBH03A	X7R	25	0.68μF	±10%	4.0	3.5	-	2.5	2.5	16.0	1DB	2000
	RCER71E105K1DBH03A	X7R	25	1.0μF	±10%	4.0	3.5	-	2.5	2.5	16.0	1DB	2000
	RCER71E155K2DBH03A	X7R	25	1.5μF	±10%	5.5	4.0	-	2.5	3.15	16.0	2DB	2000
	RCER71E225K2DBH03A	X7R	25	2.2μF	±10%	5.5	4.0	-	2.5	3.15	16.0	2DB	2000
	RCER71E335K2DBH03A	X7R	25	3.3μF	±10%	5.5	4.0	-	2.5	3.15	16.0	2DB	2000
	RCER71E475K2DBH03A	X7R	25	4.7μF	±10%	5.5	4.0	-	2.5	3.15	16.0	2DB	2000
	RCER71E106K3DBH03A	X7R	25	10μF	±10%	5.5	5.0	-	2.5	4.0	16.0	3DB	1500
	RCER71H221K0DBH03A	X7R	50	220pF	±10%	3.6	3.5	-	2.5	2.5	16.0	0DB	2000
	RCER71H331K0DBH03A	X7R	50	330pF	±10%	3.6	3.5	-	2.5	2.5	16.0	0DB	2000
	RCER71H471K0DBH03A	X7R	50	470pF	±10%	3.6	3.5	-	2.5	2.5	16.0	0DB	2000
	RCER71H681K0DBH03A	X7R	50	680pF	±10%	3.6	3.5	-	2.5	2.5	16.0	0DB	2000
	RCER71H102K0DBH03A	X7R	50	1000pF	±10%	3.6	3.5	-	2.5	2.5	16.0	0DB	2000
	RCER71H152K0DBH03A	X7R	50	1500pF	±10%	3.6	3.5	-	2.5	2.5	16.0	0DB	2000
	RCER71H222K0DBH03A	X7R	50	2200pF	±10%	3.6	3.5	-	2.5	2.5	16.0	0DB	2000
	RCER71H332K0DBH03A	X7R	50	3300pF	±10%	3.6	3.5	-	2.5	2.5	16.0	0DB	2000
	RCER71H472K0DBH03A	X7R	50	4700pF	±10%	3.6	3.5	-	2.5	2.5	16.0	0DB	2000
	RCER71H682K0DBH03A	X7R	50	6800pF	±10%	3.6	3.5	-	2.5	2.5	16.0	0DB	2000
	RCER71H103K0DBH03A	X7R	50	10000pF	±10%	3.6	3.5	-	2.5	2.5	16.0	0DB	2000
	RCER71H153K0DBH03A	X7R	50	15000pF	±10%	3.6	3.5	-	2.5	2.5	16.0	0DB	2000
	RCER71H223K0DBH03A	X7R	50	22000pF	±10%	3.6	3.5	-	2.5	2.5	16.0	0DB	2000
	RCER71H333K0DBH03A	X7R	50	33000pF	±10%	3.6	3.5	-	2.5	2.5	16.0	0DB	2000
	RCER71H473K0DBH03A	X7R	50	47000pF	±10%	3.6	3.5	-	2.5	2.5	16.0	0DB	2000
	RCER71H683K0DBH03A	X7R	50	68000pF	±10%	3.6	3.5	-	2.5	2.5	16.0	0DB	2000
	RCER71H104K0DBH03A	X7R	50	0.1μF	±10%	3.6	3.5	-	2.5	2.5	16.0	0DB	2000
	RCER71H154K1DBH03A	X7R	50	0.15μF	±10%	4.0	3.5	-	2.5	2.5	16.0	1DB	2000
	RCER71H224K1DBH03A	X7R	50	0.22μF	±10%	4.0	3.5	-	2.5	2.5	16.0	1DB	2000
	RCER71H334K1DBH03A	X7R	50	0.33μF	±10%	4.0	3.5	-	2.5	2.5	16.0	1DB	2000
	RCER71H474K1DBH03A	X7R	50	0.47μF	±10%	4.0	3.5	-	2.5	2.5	16.0	1DB	2000
	RCER71H684K2DBH03A	X7R	50	0.68μF	±10%	5.5	4.0	-	2.5	3.15	16.0	2DB	2000
	RCEC71H105K1DBH03A	X7S	50	1.0μF	±10%	4.0	3.5	-	2.5	2.5	16.0	1DB	2000
	RCER71H105K2DBH03A	X7R	50	1.0μF	±10%	5.5	4.0	-	2.5	3.15	16.0	2DB	2000
	RCER71H155K2DBH03A	X7R	50	1.5μF	±10%	5.5	4.0	-	2.5	3.15	16.0	2DB	2000
	RCER71H225K2DBH03A	X7R	50	2.2μF	±10%	5.5	4.0	-	2.5	3.15	16.0	2DB	2000
	RCER71H335K3DBH03A	X7R	50	3.3μF	±10%	5.5	5.0	-	2.5	4.0	16.0	3DB	1500
	RCEC71H475K2DBH03A	X7S	50	4.7μF	±10%	5.5	4.0	-	2.5	3.15	16.0	2DB	2000

• Straight Taping
(Lead Style:DB)

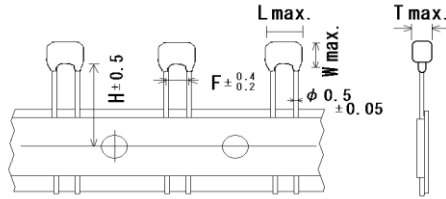

• Straight Taping
(Lead Style:DN)

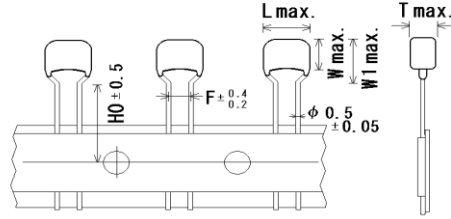

Unit : mm

Customer Part Number	Murata Part Number	T.C.	DC Rated Volt. (V)	Cap.	Cap. Tol.	Dimension (mm)						Dimension (LxW) Lead Style	Pack qty. (pcs)
						L	W	W1	F	T	H/H0		
	RCER71H475K3DBH03A	X7R	50	4.7μF	±10%	5.5	5.0	-	2.5	4.0	16.0	3DB	1500
	RCEC71H106K3DBH03A	X7S	50	10μF	±10%	5.5	5.0	-	2.5	4.0	16.0	3DB	1500
	RCER72A221K0DBH03A	X7R	100	220pF	±10%	3.6	3.5	-	2.5	2.5	16.0	0DB	2000
	RCER72A331K0DBH03A	X7R	100	330pF	±10%	3.6	3.5	-	2.5	2.5	16.0	0DB	2000
	RCER72A471K0DBH03A	X7R	100	470pF	±10%	3.6	3.5	-	2.5	2.5	16.0	0DB	2000
	RCER72A681K0DBH03A	X7R	100	680pF	±10%	3.6	3.5	-	2.5	2.5	16.0	0DB	2000
	RCER72A102K0DBH03A	X7R	100	1000pF	±10%	3.6	3.5	-	2.5	2.5	16.0	0DB	2000
	RCER72A152K0DBH03A	X7R	100	1500pF	±10%	3.6	3.5	-	2.5	2.5	16.0	0DB	2000
	RCER72A222K0DBH03A	X7R	100	2200pF	±10%	3.6	3.5	-	2.5	2.5	16.0	0DB	2000
	RCER72A332K0DBH03A	X7R	100	3300pF	±10%	3.6	3.5	-	2.5	2.5	16.0	0DB	2000
	RCER72A472K0DBH03A	X7R	100	4700pF	±10%	3.6	3.5	-	2.5	2.5	16.0	0DB	2000
	RCER72A682K0DBH03A	X7R	100	6800pF	±10%	3.6	3.5	-	2.5	2.5	16.0	0DB	2000
	RCER72A103K0DBH03A	X7R	100	10000pF	±10%	3.6	3.5	-	2.5	2.5	16.0	0DB	2000
	RCER72A153K0DBH03A	X7R	100	15000pF	±10%	3.6	3.5	-	2.5	2.5	16.0	0DB	2000
	RCER72A223K0DBH03A	X7R	100	22000pF	±10%	3.6	3.5	-	2.5	2.5	16.0	0DB	2000
	RCER72A333K1DBH03A	X7R	100	33000pF	±10%	4.0	3.5	-	2.5	2.5	16.0	1DB	2000
	RCER72A473K1DBH03A	X7R	100	47000pF	±10%	4.0	3.5	-	2.5	2.5	16.0	1DB	2000
	RCER72A683K1DBH03A	X7R	100	68000pF	±10%	4.0	3.5	-	2.5	2.5	16.0	1DB	2000
	RCER72A104K1DBH03A	X7R	100	0.1μF	±10%	4.0	3.5	-	2.5	2.5	16.0	1DB	2000
	RCER72A154K2DBH03A	X7R	100	0.15μF	±10%	5.5	4.0	-	2.5	3.15	16.0	2DB	2000
	RCER72A224K2DBH03A	X7R	100	0.22μF	±10%	5.5	4.0	-	2.5	3.15	16.0	2DB	2000
	RCER72A334K1DBH03A	X7R	100	0.33μF	±10%	4.0	3.5	-	2.5	2.5	16.0	1DB	2000
	RCER72A474K2DBH03A	X7R	100	0.47μF	±10%	5.5	4.0	-	2.5	3.15	16.0	2DB	2000
	RCER72A684K2DBH03A	X7R	100	0.68μF	±10%	5.5	4.0	-	2.5	3.15	16.0	2DB	2000
	RCEC72A105K1DBH03A	X7S	100	1.0μF	±10%	4.0	3.5	-	2.5	2.5	16.0	1DB	2000
	RCER72A105K2DBH03A	X7R	100	1.0μF	±10%	5.5	4.0	-	2.5	3.15	16.0	2DB	2000
	RCEC72A155K3DBH03A	X7S	100	1.5μF	±10%	5.5	5.0	-	2.5	4.0	16.0	3DB	1500
	RCEC72A225K2DNH03A	X7S	100	2.2μF	±10%	5.5	4.0	6.0	2.5	3.15	16.0	2DN	2000
	RCEC72A225K3DBH03A	X7S	100	2.2μF	±10%	5.5	5.0	-	2.5	4.0	16.0	3DB	1500
	RCEC72A475K3DNH03A	X7S	100	4.7μF	±10%	5.5	5.0	7.5	2.5	4.0	16.0	3DN	2000

• Inside Crimp Taping
(Lead Style: M*)

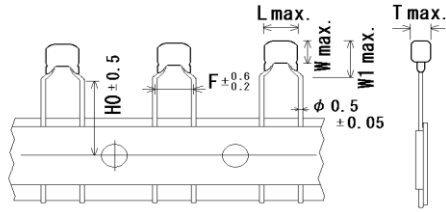

Unit : mm

Customer Part Number	Murata Part Number	T.C.	DC Rated Volt. (V)	Cap.	Cap. Tol.	Dimension (mm)						Dimension (LxW) Lead Style	Pack qty. (pcs)
						L	W	W1	F	T	H/H0		
	RCER71E104K0M1H03A	X7R	25	0.1µF	±10%	3.6	3.5	6.0	5.0	2.5	16.0	0M1	2000
	RCER71E154K0M1H03A	X7R	25	0.15µF	±10%	3.6	3.5	6.0	5.0	2.5	16.0	0M1	2000
	RCER71E224K0M1H03A	X7R	25	0.22µF	±10%	3.6	3.5	6.0	5.0	2.5	16.0	0M1	2000
	RCER71E334K1M1H03A	X7R	25	0.33µF	±10%	4.0	3.5	5.0	5.0	2.5	16.0	1M1	2000
	RCER71E474K1M1H03A	X7R	25	0.47µF	±10%	4.0	3.5	5.0	5.0	2.5	16.0	1M1	2000
	RCER71E684K1M1H03A	X7R	25	0.68µF	±10%	4.0	3.5	5.0	5.0	2.5	16.0	1M1	2000
	RCER71E105K1M1H03A	X7R	25	1.0µF	±10%	4.0	3.5	5.0	5.0	2.5	16.0	1M1	2000
	RCER71E155K2M1H03A	X7R	25	1.5µF	±10%	5.5	4.0	6.0	5.0	3.15	16.0	2M1	2000
	RCER71E225K2M1H03A	X7R	25	2.2µF	±10%	5.5	4.0	6.0	5.0	3.15	16.0	2M1	2000
	RCER71E335K2M1H03A	X7R	25	3.3µF	±10%	5.5	4.0	6.0	5.0	3.15	16.0	2M1	2000
	RCER71E475K2M1H03A	X7R	25	4.7µF	±10%	5.5	4.0	6.0	5.0	3.15	16.0	2M1	2000
	RCER71E106K3M1H03A	X7R	25	10µF	±10%	5.5	5.0	7.5	5.0	4.0	16.0	3M1	1500
	RCER71E226MWM1H03A	X7R	25	22µF	±20%	5.5	7.5	10.0	5.0	4.0	16.0	WM1	1500
	RCER71H221K0M1H03A	X7R	50	220pF	±10%	3.6	3.5	6.0	5.0	2.5	16.0	0M1	2000
	RCER71H331K0M1H03A	X7R	50	330pF	±10%	3.6	3.5	6.0	5.0	2.5	16.0	0M1	2000
	RCER71H471K0M1H03A	X7R	50	470pF	±10%	3.6	3.5	6.0	5.0	2.5	16.0	0M1	2000
	RCER71H681K0M1H03A	X7R	50	680pF	±10%	3.6	3.5	6.0	5.0	2.5	16.0	0M1	2000
	RCER71H102K0M1H03A	X7R	50	1000pF	±10%	3.6	3.5	6.0	5.0	2.5	16.0	0M1	2000
	RCER71H152K0M1H03A	X7R	50	1500pF	±10%	3.6	3.5	6.0	5.0	2.5	16.0	0M1	2000
	RCER71H222K0M1H03A	X7R	50	2200pF	±10%	3.6	3.5	6.0	5.0	2.5	16.0	0M1	2000
	RCER71H332K0M1H03A	X7R	50	3300pF	±10%	3.6	3.5	6.0	5.0	2.5	16.0	0M1	2000
	RCER71H472K0M1H03A	X7R	50	4700pF	±10%	3.6	3.5	6.0	5.0	2.5	16.0	0M1	2000
	RCER71H682K0M1H03A	X7R	50	6800pF	±10%	3.6	3.5	6.0	5.0	2.5	16.0	0M1	2000
	RCER71H103K0M1H03A	X7R	50	10000pF	±10%	3.6	3.5	6.0	5.0	2.5	16.0	0M1	2000
	RCER71H153K0M1H03A	X7R	50	15000pF	±10%	3.6	3.5	6.0	5.0	2.5	16.0	0M1	2000
	RCER71H223K0M1H03A	X7R	50	22000pF	±10%	3.6	3.5	6.0	5.0	2.5	16.0	0M1	2000
	RCER71H333K0M1H03A	X7R	50	33000pF	±10%	3.6	3.5	6.0	5.0	2.5	16.0	0M1	2000
	RCER71H473K0M1H03A	X7R	50	47000pF	±10%	3.6	3.5	6.0	5.0	2.5	16.0	0M1	2000
	RCER71H683K0M1H03A	X7R	50	68000pF	±10%	3.6	3.5	6.0	5.0	2.5	16.0	0M1	2000
	RCER71H104K0M1H03A	X7R	50	0.1µF	±10%	3.6	3.5	6.0	5.0	2.5	16.0	0M1	2000
	RCER71H154K1M1H03A	X7R	50	0.15µF	±10%	4.0	3.5	5.0	5.0	2.5	16.0	1M1	2000
	RCER71H224K1M1H03A	X7R	50	0.22µF	±10%	4.0	3.5	5.0	5.0	2.5	16.0	1M1	2000
	RCER71H334K1M1H03A	X7R	50	0.33µF	±10%	4.0	3.5	5.0	5.0	2.5	16.0	1M1	2000
	RCER71H474K1M1H03A	X7R	50	0.47µF	±10%	4.0	3.5	5.0	5.0	2.5	16.0	1M1	2000
	RCER71H684K2M1H03A	X7R	50	0.68µF	±10%	5.5	4.0	6.0	5.0	3.15	16.0	2M1	2000
	RCEC71H105K1M1H03A	X7S	50	1.0µF	±10%	4.0	3.5	5.0	5.0	2.5	16.0	1M1	2000
	RCER71H105K2M1H03A	X7R	50	1.0µF	±10%	5.5	4.0	6.0	5.0	3.15	16.0	2M1	2000
	RCER71H155K2M1H03A	X7R	50	1.5µF	±10%	5.5	4.0	6.0	5.0	3.15	16.0	2M1	2000
	RCER71H225K2M1H03A	X7R	50	2.2µF	±10%	5.5	4.0	6.0	5.0	3.15	16.0	2M1	2000
	RCER71H335K3M1H03A	X7R	50	3.3µF	±10%	5.5	5.0	7.5	5.0	4.0	16.0	3M1	1500

• Inside Crimp Taping
(Lead Style: M*)

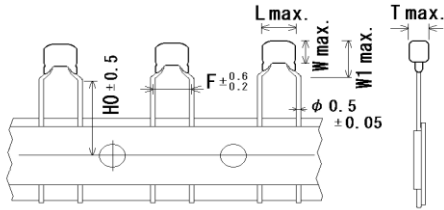

Unit : mm

Customer Part Number	Murata Part Number	T.C.	DC Rated Volt. (V)	Cap.	Cap. Tol.	Dimension (mm)						Dimension (LxW) Lead Style	Pack qty. (pcs)
						L	W	W1	F	T	H/H0		
	RCEC71H475K2M1H03A	X7S	50	4.7μF	±10%	5.5	4.0	6.0	5.0	3.15	16.0	2M1	2000
	RCER71H475K3M1H03A	X7R	50	4.7μF	±10%	5.5	5.0	7.5	5.0	4.0	16.0	3M1	1500
	RCEC71H106K3M1H03A	X7S	50	10μF	±10%	5.5	5.0	7.5	5.0	4.0	16.0	3M1	1500
	RCER71H106MWM1H03A	X7R	50	10μF	±20%	5.5	7.5	10.0	5.0	4.0	16.0	WM1	1500
	RCEC71H226MWM1H03A	X7S	50	22μF	±20%	5.5	7.5	10.0	5.0	4.0	16.0	WM1	1500
	RCER72A221K0M1H03A	X7R	100	220pF	±10%	3.6	3.5	6.0	5.0	2.5	16.0	0M1	2000
	RCER72A331K0M1H03A	X7R	100	330pF	±10%	3.6	3.5	6.0	5.0	2.5	16.0	0M1	2000
	RCER72A471K0M1H03A	X7R	100	470pF	±10%	3.6	3.5	6.0	5.0	2.5	16.0	0M1	2000
	RCER72A681K0M1H03A	X7R	100	680pF	±10%	3.6	3.5	6.0	5.0	2.5	16.0	0M1	2000
	RCER72A102K0M1H03A	X7R	100	1000pF	±10%	3.6	3.5	6.0	5.0	2.5	16.0	0M1	2000
	RCER72A152K0M1H03A	X7R	100	1500pF	±10%	3.6	3.5	6.0	5.0	2.5	16.0	0M1	2000
	RCER72A222K0M1H03A	X7R	100	2200pF	±10%	3.6	3.5	6.0	5.0	2.5	16.0	0M1	2000
	RCER72A332K0M1H03A	X7R	100	3300pF	±10%	3.6	3.5	6.0	5.0	2.5	16.0	0M1	2000
	RCER72A472K0M1H03A	X7R	100	4700pF	±10%	3.6	3.5	6.0	5.0	2.5	16.0	0M1	2000
	RCER72A682K0M1H03A	X7R	100	6800pF	±10%	3.6	3.5	6.0	5.0	2.5	16.0	0M1	2000
	RCER72A103K0M1H03A	X7R	100	10000pF	±10%	3.6	3.5	6.0	5.0	2.5	16.0	0M1	2000
	RCER72A153K0M1H03A	X7R	100	15000pF	±10%	3.6	3.5	6.0	5.0	2.5	16.0	0M1	2000
	RCER72A223K0M1H03A	X7R	100	22000pF	±10%	3.6	3.5	6.0	5.0	2.5	16.0	0M1	2000
	RCER72A333K1M1H03A	X7R	100	33000pF	±10%	4.0	3.5	5.0	5.0	2.5	16.0	1M1	2000
	RCER72A473K1M1H03A	X7R	100	47000pF	±10%	4.0	3.5	5.0	5.0	2.5	16.0	1M1	2000
	RCER72A683K1M1H03A	X7R	100	68000pF	±10%	4.0	3.5	5.0	5.0	2.5	16.0	1M1	2000
	RCER72A104K1M1H03A	X7R	100	0.1μF	±10%	4.0	3.5	5.0	5.0	2.5	16.0	1M1	2000
	RCER72A154K2M1H03A	X7R	100	0.15μF	±10%	5.5	4.0	6.0	5.0	3.15	16.0	2M1	2000
	RCER72A224K2M1H03A	X7R	100	0.22μF	±10%	5.5	4.0	6.0	5.0	3.15	16.0	2M1	2000
	RCER72A334K1M1H03A	X7R	100	0.33μF	±10%	4.0	3.5	5.0	5.0	2.5	16.0	1M1	2000
	RCER72A474K2M1H03A	X7R	100	0.47μF	±10%	5.5	4.0	6.0	5.0	3.15	16.0	2M1	2000
	RCER72A684K2M1H03A	X7R	100	0.68μF	±10%	5.5	4.0	6.0	5.0	3.15	16.0	2M1	2000
	RCEC72A105K1M1H03A	X7S	100	1.0μF	±10%	4.0	3.5	5.0	5.0	2.5	16.0	1M1	2000
	RCER72A105K2M1H03A	X7R	100	1.0μF	±10%	5.5	4.0	6.0	5.0	3.15	16.0	2M1	2000
	RCEC72A155K3M1H03A	X7S	100	1.5μF	±10%	5.5	5.0	7.5	5.0	4.0	16.0	3M1	1500
	RCEC72A225K2M1H03A	X7S	100	2.2μF	±10%	5.5	4.0	6.0	5.0	3.15	16.0	2M1	2000
	RCEC72A225K3M1H03A	X7S	100	2.2μF	±10%	5.5	5.0	7.5	5.0	4.0	16.0	3M1	1500
	RCEC72A475K3M1H03A	X7S	100	4.7μF	±10%	5.5	5.0	7.5	5.0	4.0	16.0	3M1	2000
	RCEC72A475MWM1H03A	X7S	100	4.7μF	±20%	5.5	7.5	10.0	5.0	4.0	16.0	WM1	1500

Reference only

5. Specification																		
No.	Test Item	Specification	Test Method (Compliant Standard:AEC-Q200)															
1	Pre-and Post-Stress Electrical Test																	
2	High Temperature Exposure (Storage)	Appearance	No defects or abnormalities															
		Capacitance Change	within $\pm 12.5\%$															
		D.F.	0.04 max. * 1															
		I.R.	More than 1,000M Ω or 50 M Ω · μ F (Whichever is smaller)															
			Sit the capacitor for 1000 \pm 12h at 150 \pm 3°C. Let sit for 24 \pm 2h at *room condition then measure. *Pretreatment Perform the heat treatment at 150+0/-10°C for 60 \pm 5 min and then let sit for 24 \pm 2 h at *room condition.															
3	Temperature Cycling	Appearance	No defects or abnormalities															
		Capacitance Change	within $\pm 12.5\%$															
		D.F.	0.05 max. * 1															
		I.R.	1,000M Ω or 50M Ω · μ F min. (Whichever is smaller)															
			Perform the 1000 cycles according to the four heat treatments listed in the following table. Let sit for 24 \pm 2 h at *room condition, then measure.															
			<table border="1"> <thead> <tr> <th>Step</th> <th>1</th> <th>2</th> <th>3</th> <th>4</th> </tr> </thead> <tbody> <tr> <td>Temp. (°C)</td> <td>-55+0/-3</td> <td>Room Temp.</td> <td>125+3/-0</td> <td>Room Temp.</td> </tr> <tr> <td>Time (min.)</td> <td>15\pm3</td> <td>1</td> <td>15\pm3</td> <td>1</td> </tr> </tbody> </table>	Step	1	2	3	4	Temp. (°C)	-55+0/-3	Room Temp.	125+3/-0	Room Temp.	Time (min.)	15 \pm 3	1	15 \pm 3	1
Step	1	2	3	4														
Temp. (°C)	-55+0/-3	Room Temp.	125+3/-0	Room Temp.														
Time (min.)	15 \pm 3	1	15 \pm 3	1														
			*Pretreatment Perform the heat treatment at 150+0/-10°C for 60 \pm 5 min and then let sit for 24 \pm 2 h at *room condition.															
4	Moisture Resistance	Appearance	No defects or abnormalities															
		Capacitance Change	within $\pm 12.5\%$															
		D.F.	0.05 max. * 1															
		I.R.	500M Ω or 25M Ω · μ F min. (Whichever is smaller)															
			Apply the 24h heat (25 to 65°C) and humidity (80 to 98%) treatment shown below, 10 consecutive times. Let sit for 24 \pm 2 h at *room condition, then measure.															
			*Pretreatment Perform the heat treatment at 150+0/-10°C for 60 \pm 5 min and then let sit for 24 \pm 2 h at *room condition.															
5	Biased Humidity	Appearance	No defects or abnormalities															
		Capacitance Change	within $\pm 12.5\%$ * 2															
		D.F.	0.05 max. * 1															
		I.R.	500M Ω or 25M Ω · μ F min. * 3 (Whichever is smaller)															
			Apply the rated voltage and DC1.3+0.2/-0V (add 100k Ω resistor) at 85 \pm 3°C and 80 to 85% humidity for 1000 \pm 12h. Remove and let sit for 24 \pm 2 h at *room condition, then measure. The charge/discharge current is less than 50mA. *Pretreatment Perform the heat treatment at 150+0/-10°C for 60 \pm 5 min and then let sit for 24 \pm 2 h at *room condition.															
6	Operational Life	Appearance	No defects or abnormalities															
		Capacitance Change	within $\pm 12.5\%$ * 2															
		D.F.	0.04 max. * 1															
		I.R.	1,000M Ω or 50M Ω · μ F min. * 4 (Whichever is smaller)															
			Apply 200% of the rated voltage * 5 for 1000 \pm 12h at 125 \pm 3°C. Let sit for 24 \pm 2 h at *room condition, then measure. The charge/discharge current is less than 50mA. *Pretreatment Apply test voltage for 60 \pm 5 min at test temperature. Remove and let sit for 24 \pm 2 h at *room condition.															
* "room condition" Temperature : 15 to 35°C, Relative humidity : 45 to 75%, Atmosphere pressure : 86 to 106kPa																		
Below parts are applicable in		* 5 Below parts are applicable in rated voltage \times 150%.																
* 1 D.F. : 0.2 max.																		
* 2 Capacitance Change : within $\pm 15\%$																		
* 3 I.R. : 12.5M Ω · μ F min.																		
* 4 I.R. : 25M Ω · μ F min.																		
Char.	Rated Voltage	Capacitance	Dimensions															
C7	2A	105	1															
C7	2A	225	2															
C7	2A	475	3															
Char.	Rated Voltage	Capacitance	Dimensions															
C7	2A	105	1															
C7	2A	225	2															
C7	2A	155-475	3															
C7	2A	475	W															

Reference only

No.	Test Item	Specification	Test Method (Compliant Standard:AEC-Q200)																
7	External Visual	No defects or abnormalities	Visual inspection																
8	Physical Dimension	Within the specified dimensions	Using calipers and micrometers.																
9	Marking	To be easily legible.	Visual inspection																
10	Resistance to Solvents	Appearance	Per MIL-STD-202 Method 215 Solvent 1 : 1 part (by volume) of isopropyl alcohol 3 parts (by volume) of mineral spirits Solvent 2 : Terpene defluxer Solvent 3 : 42 parts (by volume) of water 1part (by volume) of propylene glycol monomethyl ether 1 part (by volume) of monoethanolamine																
		Capacitance																	
		D.F.																	
		I.R.																	
		More than 10,000MΩ or 500 MΩ·μF * 7 (Whichever is smaller)																	
11	Mechanical Shock	Appearance	Three shocks in each direction should be applied along 3 mutually perpendicular axes of the test specimen (18 shocks). The specified test pulse should be Half-sine and should have a duration : 0.5ms, peak value : 1500G and velocity change : 4.7m/s.																
		Capacitance																	
		D.F.																	
		0.025 max. * 6																	
12	Vibration	Appearance	The capacitor should be subjected to a simple harmonic motion having a total amplitude of 1.5mm, the frequency being varied uniformly between the approximate limits of 10 and 2,000Hz. The frequency range, from 10 to 2000Hz and return to 10Hz, should be traversed in approximately 20 min. This motion should be applied for 12 items in each 3 mutually perpendicular directions (total of 36 times).																
		Capacitance																	
		D.F.																	
		0.025 max. * 6																	
13-1	Resistance to Soldering Heat (Non-Preheat)	Appearance	The lead wires should be immersed in the melted solder 1.5 to 2.0mm from the root of terminal at 260±5°C for 10±1 seconds. • Pre-treatment Capacitor should be stored at 150+0/-10°C for one hour, then place at *room condition for 24±2 hours before initial measurement. • Post-treatment Capacitor should be stored for 24±2 hours at *room condition.																
		Capacitance Change																	
		Dielectric Strength (Between terminals)																	
		Within ±7.5% * 8 No defects																	
13-2	Resistance to Soldering Heat (On-Preheat)	Appearance	First the capacitor should be stored at 120+0/-5°C for 60+0/-5 seconds. Then, the lead wires should be immersed in the melted solder 1.5 to 2.0mm from the root of terminal at 260±5°C for 7.5+0/-1 seconds. • Pre-treatment Capacitor should be stored at 150+0/-10°C for one hour, then place at *room condition for 24±2 hours before initial measurement. • Post-treatment Capacitor should be stored for 24±2 hours at *room condition.																
		Capacitance Change																	
		Dielectric Strength (Between terminals)																	
		Within ±7.5% * 8 No defects																	
13-3	Resistance to Soldering Heat (soldering iron method)	Appearance	Test condition Temperature of iron-tip : 350±10°C Soldering time : 3.5±0.5 seconds Soldering position Straight Lead : 1.5 to 2.0mm from the root of terminal. Crimp Lead : 1.5 to 2.0mm from the end of lead bend. • Pre-treatment Capacitor should be stored at 150+0/-10°C for one hour, then place at *room condition for 24±2 hours before initial measurement. • Post-treatment Capacitor should be stored for 24±2 hours at *room condition.																
		Capacitance Change																	
		Dielectric Strength (Between terminals)																	
		Within ±7.5% * 8 No defects																	
14	Thermal Shock	Appearance	Perform the 300 cycles according to the two heat treatments listed in the following table(Maximum transfer time is 20s.). Let sit for 24±2 h at *room condition, then measure. <table border="1" style="margin-left: auto; margin-right: auto;"> <thead> <tr> <th>Step</th> <th>1</th> <th>2</th> </tr> </thead> <tbody> <tr> <td>Temp. (°C)</td> <td>-55+0/-3</td> <td>125+3/-0</td> </tr> <tr> <td>Time (min.)</td> <td>15±3</td> <td>15±3</td> </tr> </tbody> </table> •Pretreatment Perform the heat treatment at 150+0/-10°C for 60±5 min and then let sit for 24±2 h at *room condition.	Step	1	2	Temp. (°C)	-55+0/-3	125+3/-0	Time (min.)	15±3	15±3							
		Step		1	2														
		Temp. (°C)		-55+0/-3	125+3/-0														
		Time (min.)		15±3	15±3														
Capacitance Change																			
D.F.																			
		0.05 max. * 1 1,000MΩ or 50MΩ·μF min. (Whichever is smaller)																	
<p>* "room condition" Temperature : 15 to 35°C, Relative humidity : 45 to 75%, Atmosphere pressure : 86 to 106kPa</p> <p>Below parts are applicable in</p> <ul style="list-style-type: none"> * 1 D.F. : 0.2 max. * 6 D.F. : 0.125 max. * 7 I.R. : 50 MΩ · μF min. * 8 Capacitance Change : within ±10% <table border="1" style="margin-left: auto; margin-right: auto;"> <thead> <tr> <th>Char.</th> <th>Rated Voltage</th> <th>Capacitance</th> <th>Dimensions</th> </tr> </thead> <tbody> <tr> <td>C7</td> <td>2A</td> <td>105</td> <td>1</td> </tr> <tr> <td>C7</td> <td>2A</td> <td>225</td> <td>2</td> </tr> <tr> <td>C7</td> <td>2A</td> <td>475</td> <td>3</td> </tr> </tbody> </table>				Char.	Rated Voltage	Capacitance	Dimensions	C7	2A	105	1	C7	2A	225	2	C7	2A	475	3
Char.	Rated Voltage	Capacitance	Dimensions																
C7	2A	105	1																
C7	2A	225	2																
C7	2A	475	3																

Reference only

No.	Test Item		Specification	Test Method (Compliant Standard:AEC-Q200)																
15	ESD	Appearance	No defects or abnormalities	Per AEC-Q200-002																
		Capacitance	Within the specified tolerance																	
		D.F.	0.025 max. * 6																	
		I.R.	More than 10,000MΩ or 500 MΩ·μF * 7 (Whichever is smaller)																	
16	Solderability		Lead wire should be soldered with uniform coating on the axial direction over 95% of the circumferential direction.	Should be placed into steam aging for 8h±15 min. The terminal of capacitor is dipped into a solution of rosin ethanol (25% rosin in weight proportion). Immerse in solder solution for 2±0.5 seconds. In both cases the depth of dipping is up to about 1.5 to 2mm from the terminal body. Temp. of solder : 245±5°C (Sn-3.0Ag-0.5Cu)																
17	Electrical Characterization	Appearance	No defects or abnormalities	Visual inspection.																
		Capacitance	Within the specified tolerance	The capacitance/D.F. should be measured at 25°C at the frequency and voltage shown in the table.																
		D.F.	0.025 max. * 6																	
		<table border="1"> <thead> <tr> <th>Nominal Cap.</th> <th>Frequency</th> <th>Voltage</th> </tr> </thead> <tbody> <tr> <td>C ≤ 10μF</td> <td>1±0.1kHz</td> <td>AC1±0.2V (r.m.s.)</td> </tr> <tr> <td>C > 10μF</td> <td>120±24Hz</td> <td>AC0.5±0.1V (r.m.s.)</td> </tr> </tbody> </table>			Nominal Cap.	Frequency	Voltage	C ≤ 10μF	1±0.1kHz	AC1±0.2V (r.m.s.)	C > 10μF	120±24Hz	AC0.5±0.1V (r.m.s.)							
		Nominal Cap.	Frequency	Voltage																
C ≤ 10μF	1±0.1kHz	AC1±0.2V (r.m.s.)																		
C > 10μF	120±24Hz	AC0.5±0.1V (r.m.s.)																		
I.R.	Between Terminals	10,000MΩ or 500MΩ·μF min. * 7 (Whichever is smaller)	The insulation resistance should be measured with a DC voltage not exceeding the rated voltage at 25 °C within 2 min. of charging.																	
Dielectric Strength	Between Terminals	No defects or abnormalities	The capacitor should not be damaged when DC voltage of 250% of the rated voltage * 9 is applied between the terminations for 1 to 5 seconds. (Charge/Discharge current ≤ 50mA.)																	
	Terminal To External Resin	No defects or abnormalities	The capacitor is placed in a container with metal balls of 1mm diameter so that each terminal, short-circuit is kept approximately 2mm from the balls, and 250% of the rated DC voltage is impressed for 1 to 5 seconds between capacitor terminals and metal balls. (Charge/Discharge current ≤ 50mA.)																	
18	Terminal Strength	Tensile Strength	Termination not to be broken or loosened	As in the figure, fix the capacitor body, apply the force gradually to each lead in the radial direction of the capacitor until reaching 10N and then keep the force applied for 10±1 seconds. 																
		Bending Strength	Termination not to be broken or loosened	Each lead wire should be subjected to a force of 2.5N and then be bent 90° at the point of egress in one direction. Each wire is then returned to the original position and bent 90° in the opposite direction at the rate of one bend per 2 to 3 seconds.																
19	Capacitance Temperature Characteristics		Char.X7R : Within ±15% Char.X7S : Within ±22%	The capacitance change should be measured after 5min. at each specified temperature step. <table border="1"> <thead> <tr> <th>Step</th> <th>Temperature(°C)</th> </tr> </thead> <tbody> <tr> <td>1</td> <td>25±2</td> </tr> <tr> <td>2</td> <td>-55±3</td> </tr> <tr> <td>3</td> <td>25±2</td> </tr> <tr> <td>4</td> <td>125±3</td> </tr> <tr> <td>5</td> <td>25±2</td> </tr> </tbody> </table> The ranges of capacitance change compared with the above 25°C value over the temperature ranges shown in the table should be within the specified ranges. •Pretreatment Perform the heat treatment at 150+0/-10°C for 60±5 min and then let sit for 24±2 h at *room condition. Perform the initial measurement.	Step	Temperature(°C)	1	25±2	2	-55±3	3	25±2	4	125±3	5	25±2				
Step	Temperature(°C)																			
1	25±2																			
2	-55±3																			
3	25±2																			
4	125±3																			
5	25±2																			
<p>* "room condition" Temperature : 15 to 35°C, Relative humidity : 45 to 75%, Atmosphere pressure : 86 to 106kPa</p> <p>Below parts are applicable in</p> <ul style="list-style-type: none"> * 6 D.F. : 0.125 max. * 7 I.R. : 50 MΩ · μF min. * 9 Rated voltage×200% <table border="1"> <thead> <tr> <th></th> <th>Rated Voltage</th> <th>Capacitance</th> <th>Dimensions</th> </tr> </thead> <tbody> <tr> <td>C7</td> <td>2A</td> <td>105</td> <td>1</td> </tr> <tr> <td>C7</td> <td>2A</td> <td>225</td> <td>2</td> </tr> <tr> <td>C7</td> <td>2A</td> <td>475</td> <td>3</td> </tr> </tbody> </table>						Rated Voltage	Capacitance	Dimensions	C7	2A	105	1	C7	2A	225	2	C7	2A	475	3
	Rated Voltage	Capacitance	Dimensions																	
C7	2A	105	1																	
C7	2A	225	2																	
C7	2A	475	3																	

6. Packing specification

- Bulk type (Packing style code : B)

The size of packing case and packing way

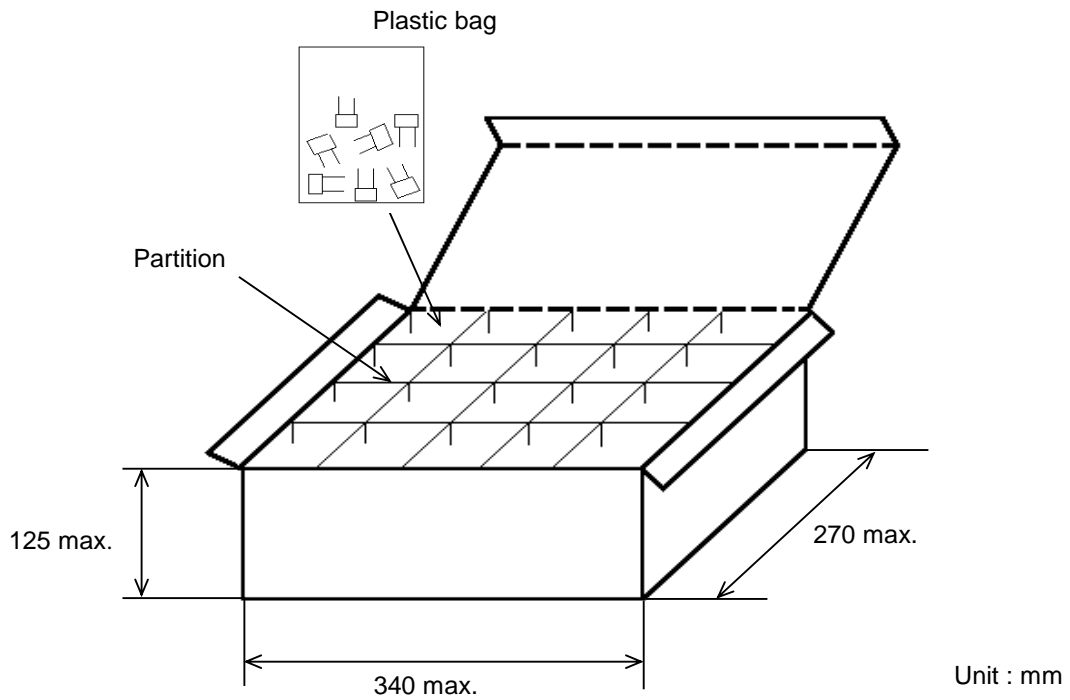

The number of packing = ^{*1} Packing quantity × ^{*2} n

*1 : Please refer to [Part number list].

*2 : Standard n = 20 (bag)

Note)

The outer package and the number of outer packing be changed by the order getting amount.

• Ammo pack taping type (Packing style code : A)

A crease is made every 25 pitches, and the tape with capacitors is packed zigzag into a case. When body of the capacitor is piled on other body under it.

The size of packing case and packing way

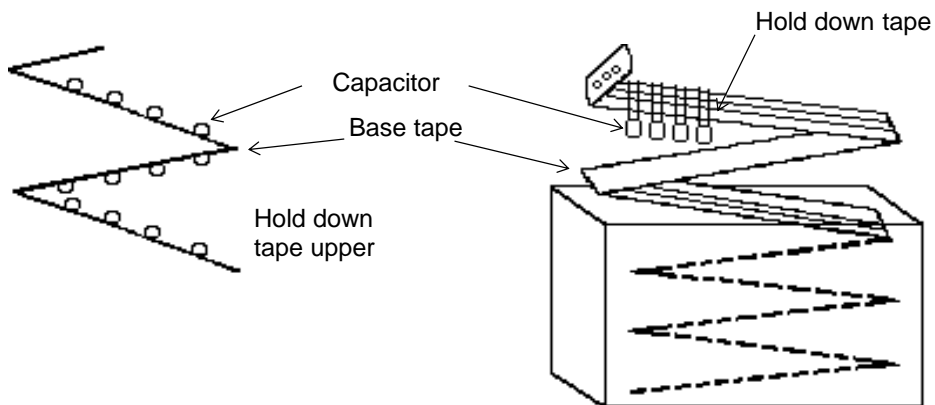
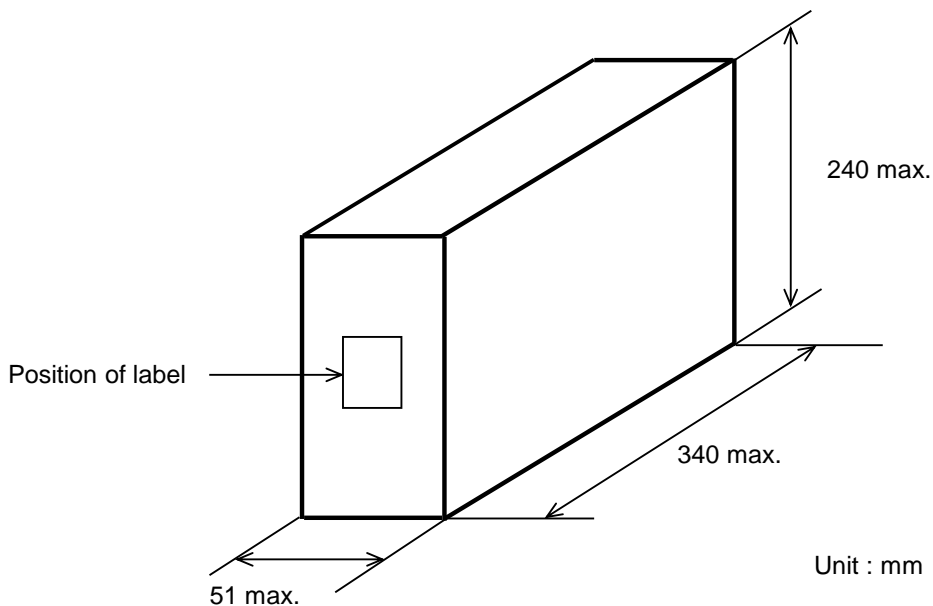

7. Taping specification

7-1. Dimension of capacitors on tape

Straight taping type < Lead Style : DB >

Pitch of component 12.7mm / Lead spacing 2.5mm

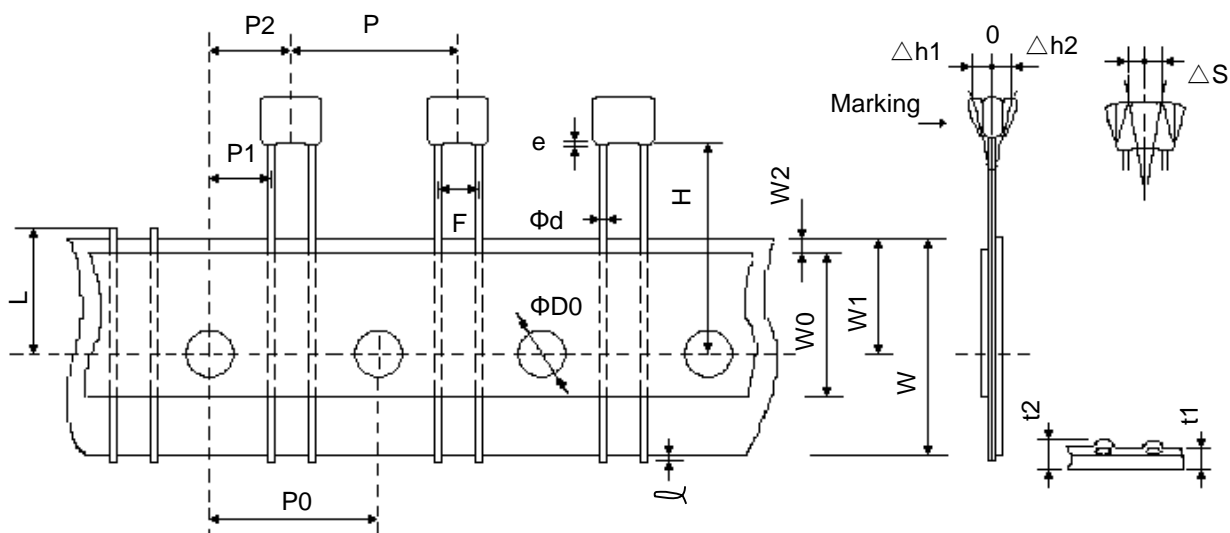

Unit : mm

Item	Code	Dimensions	Remarks
Pitch of component	P	12.7+/-1.0	
Pitch of sprocket hole	P0	12.7+/-0.2	
Lead spacing	F	2.5+0.4/-0.2	
Length from hole center to component center	P2	6.35+/-1.3	Deviation of progress direction
Length from hole center to lead	P1	5.1+/-0.7	
Deviation along tape, left or right defect	ΔS	0+/-2.0	They include deviation by lead bend
Carrier tape width	W	18.0+/-0.5	
Position of sprocket hole	W1	9.0+0/-0.5	Deviation of tape width direction
Lead distance between reference and bottom plane	H	16.0+/-0.5	
Protrusion length	ℓ	0.5 max.	
Diameter of sprocket hole	ΦD0	4.0+/-0.1	
Lead diameter	Φd	0.5+/-0.05	
Total tape thickness	t1	0.6+/-0.3	They include hold down tape thickness
Total thickness of tape and lead wire	t2	1.5 max.	
Deviation across tape	Δh1	1.0 max.	
	Δh2		
Portion to cut in case of defect	L	11.0+0/-1.0	
Hold down tape width	W0	9.5 min.	
Hold down tape position	W2	1.5+/-1.5	
Coating extension on lead	e	1.5 max.	

Reference only

Straight taping type < Lead Style : DN >

Pitch of component 12.7mm / Lead spacing 2.5mm

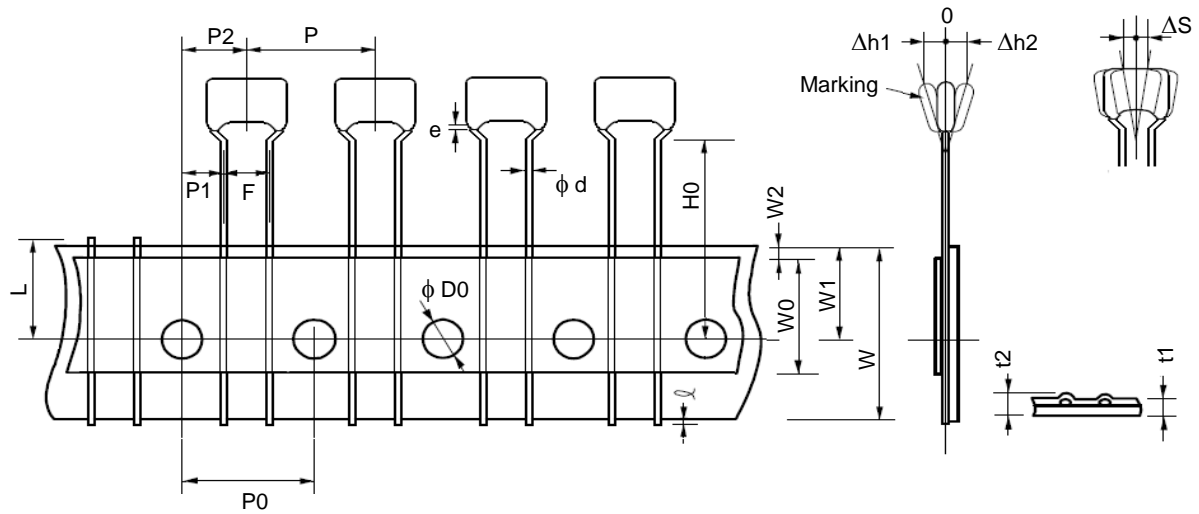

Unit : mm

Item	Code	Dimensions	Remarks
Pitch of component	P	12.7+/-1.0	
Pitch of sprocket hole	P0	12.7+/-0.2	
Lead spacing	F	2.5+0.4/-0.2	
Length from hole center to component center	P2	6.35+/-1.3	Deviation of progress direction
Length from hole center to lead	P1	5.1+/-0.7	
Deviation along tape, left or right defect	ΔS	0+/-2.0	They include deviation by lead bend
Carrier tape width	W	18.0+/-0.5	
Position of sprocket hole	W1	9.0+0/-0.5	Deviation of tape width direction
Lead distance between reference and bottom plane	H0	16.0+/-0.5	
Protrusion length	ℓ	0.5 max.	
Diameter of sprocket hole	ΦD0	4.0+/-0.1	
Lead diameter	Φd	0.5+/-0.05	
Total tape thickness	t1	0.6+/-0.3	They include hold down tape thickness
Total thickness of tape and lead wire	t2	1.5 max.	
Deviation across tape	Δh1	1.0 max.	
	Δh2		
Portion to cut in case of defect	L	11.0+0/-1.0	
Hold down tape width	W0	9.5 min.	
Hold down tape position	W2	1.5+/-1.5	
Coating extension on lead	e	Up to the end of crimp	

ETP1DN01

Reference only

Inside crimp taping type < Lead Style : M1 >
 Pitch of component 12.7mm / Lead spacing 5.0mm

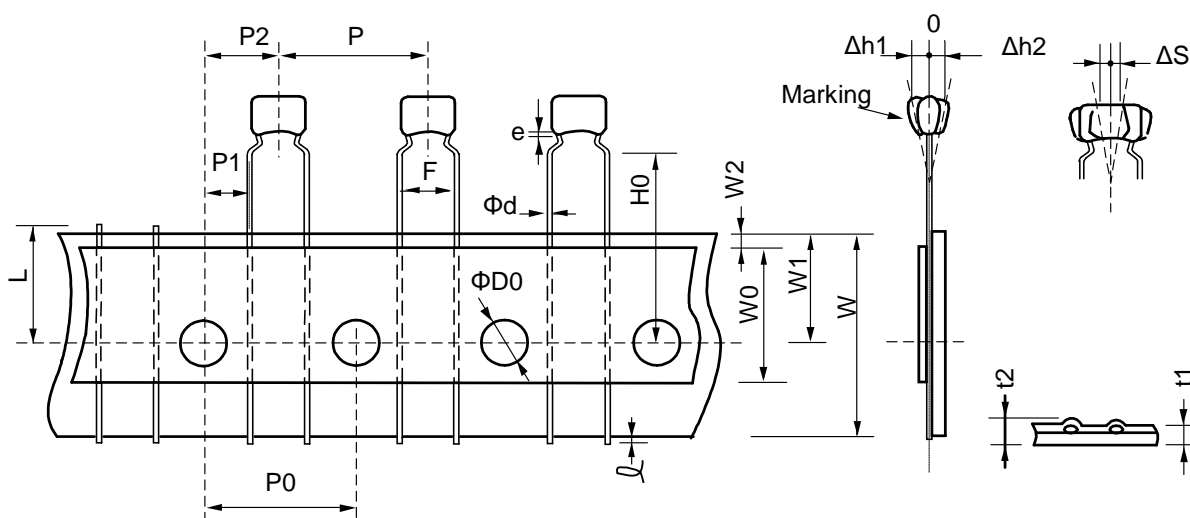

Unit : mm

Item	Code	Dimensions	Remarks
Pitch of component	P	12.7+/-1.0	
Pitch of sprocket hole	P0	12.7+/-0.2	
Lead spacing	F	5.0+0.6/-0.2	
Length from hole center to component center	P2	6.35+/-1.3	Deviation of progress direction
Length from hole center to lead	P1	3.85+/-0.7	
Deviation along tape, left or right defect	ΔS	0+/-2.0	They include deviation by lead bend
Carrier tape width	W	18.0+/-0.5	
Position of sprocket hole	W1	9.0+0/-0.5	Deviation of tape width direction
Lead distance between reference and bottom plane	H0	16.0+/-0.5	
Protrusion length	ℓ	0.5 max.	
Diameter of sprocket hole	ΦD0	4.0+/-0.1	
Lead diameter	Φd	0.5+/-0.05	
Total tape thickness	t1	0.6+/-0.3	They include hold down tape thickness
Total thickness of tape and lead wire	t2	1.5 max.	
Deviation across tape	Δh1	2.0 max. (Dimension code : W)	
	Δh2	1.0 max. (except as above)	
Portion to cut in case of defect	L	11.0+0/-1.0	
Hold down tape width	W0	9.5 min.	
Hold down tape position	W2	1.5+/-1.5	
Coating extension on lead	e	Up to the end of crimp	

7-2. Splicing way of tape

- 1) Adhesive force of tape is over 3N at test condition as below.

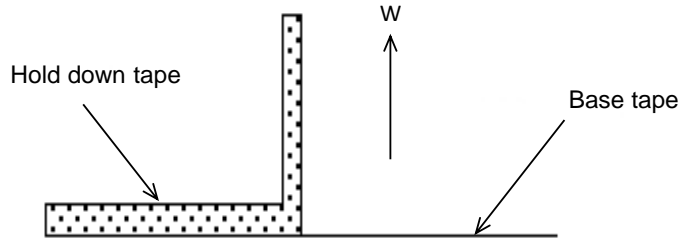

2) Splicing of tape

- (a) When base tape is spliced

- Base tape shall be spliced by cellophane tape.
- (Total tape thickness shall be less than 1.05mm.)

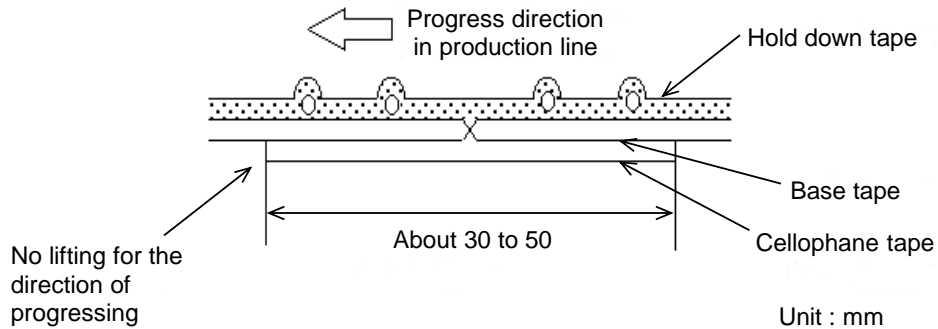

- (b) When hold down tape is spliced

- Hold down tape shall be spliced with overlapping.
- (Total tape thickness shall be less than 1.05mm.)

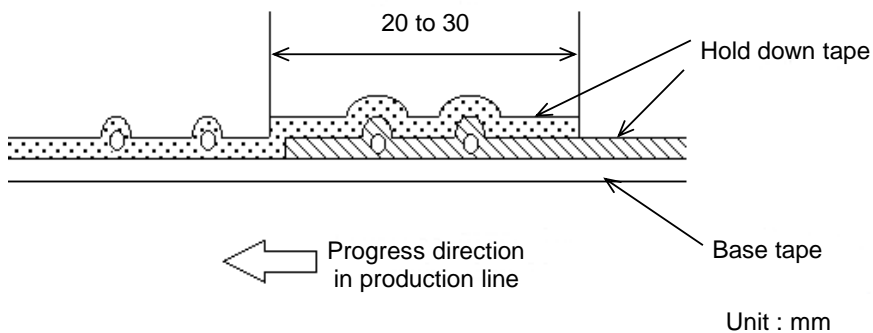

- (c) When both tape are spliced



- Base tape and hold down tape shall be spliced with splicing tape.

3) Missing components







- There should be no consecutive missing of more than three components.
- The number of missing components should be not more than 0.5 % of total components that should be present in a Ammo pack.

Looking for pricing, stock, or lifecycle information?

Click below to explore more details on WIN SOURCE:

-  [View RCER71H473K0M1H03A on WIN SOURCE](#)
-  [Murata Electronics North America Information](#)

Optimize Your Supply Chain with WIN SOURCE Solutions

-  Global Sourcing Solution
-  Obsolete Management
-  Cost Control Management
-  Shortage Management
-  Alternative Solution
-  Excess Inventory Management