



**THE DATASHEET OF  
MAX20404AF0B/VY+**



## Automotive 36V, 4A/5A/6A, Fully Integrated Synchronous Silent Switcher Buck Converters

## MAX20404/MAX20405/MAX20406

### General Description

The MAX20404/MAX20405/MAX20406/MAX20406E ICs are tiny, low EMI emission, synchronous Silent Switcher<sup>®</sup> buck converters with integrated high-side and low-side switches. The ICs are designed to deliver up to 6A with wide input voltages range from 3V to 36V. Voltage quality can be monitored by observing the PGOOD signal. The MAX20404/MAX20405/MAX20406/MAX20406E can operate in dropout by running at 99% duty cycle, making them ideal for automotive and industrial applications.

The MAX20404/MAX20405/MAX20406/MAX20406E offer programmable or fixed output voltages of 5V and 3.3V. The frequency is internally fixed at 2.1MHz (or 400kHz, 2.3MHz, or 3MHz) which allows for small external components, reduced output ripple, and guarantees no AM interference. The MAX20404/MAX20405/MAX20406/MAX20406E automatically enter skip mode at light loads with ultra-low quiescent current of 10 $\mu$ A at no load. This family of products (including the MAX20408/MAX20410) offers a pin-to-pin compatible offering from 4A to 10A in a single-phase configuration, and up to 20A in a dual-phase configuration. These devices have also been optimized for dual-phase operation with very high current sharing accuracy. These devices can be ordered with spread-spectrum frequency modulation designed to minimize EMI-radiated emissions due to the modulation frequency.

This device features the MAXQ<sup>®</sup> power architecture, which provides precision transient performance and phase margin. This allows obtaining the maximum power, performance, and precision while minimizing system cost for any specific application.

The MAX20404/MAX20405/MAX20406/MAX20406E are available in a small 3.5mm x 3.75mm, 17-pin and 15-pin FC2QFN packages and use very few external components.

### Applications

- Automotive
  - Infotainment Systems
  - ADAS and Other Safety-Critical Applications
- Industrial
- High-Voltage DC-DC Converters

### Benefits and Features

- Silent Switcher Converter
  - Enables Compact, Efficient, Low-EMI Solution
  - Spread-Spectrum Frequency Modulation
  - Symmetrical Package Offers Superior EMI Performance
  - CISPR 25 Class 5-Compliant EV Kit
- Multiple Functions for Small Size
  - Operating  $V_{IN}$  Range of 3V to 36V
  - 10 $\mu$ A Quiescent Current in Skip Mode
  - Synchronous DC-DC Converter with Integrated FETs
  - 400kHz, 2.1MHz, 2.3MHz, and 3MHz Fixed-Frequency Options
  - Fixed 2.5ms Internal Soft-Start
  - Programmable 0.8V to 10V Output, or Fixed-Output Voltages of 3.3V, 3.9V, 4.2V, and 5.0V
  - Other Fixed-Output Options Available between 2.9V to 6V in 100mV Steps
  - 3.5mm x 3.75mm, 17-Pin and 15-Pin FC2QFN
- Dual-Phase Capability
  - Can Be Used in Dual-Phase Configuration for High-Power Design
  - Dynamic Current Sharing through Shared VEA Pin
  - Low- $I_Q$  Operation Capability in Dual Phase
- High Precision
  - $\pm 1\%$  Output-Voltage Accuracy in FPWM Mode
  - MAXQ Power Architecture
  - Precise Output Voltage Monitoring with PGOOD
- Robust for the Automotive Environment
  - Forced-PWM and Skip-Mode Operation
  - 99% Duty-Cycle Operation with Low Dropout
  - Overtemperature and Short-Circuit Protection
  - -40°C to +125°C Operating Temperature Range
  - 42V Load-Dump Tolerant
  - AEC-Q100 Qualified

Ordering Information appears at end of data sheet.

*Silent Switcher is a registered trademark of Analog Devices, Inc.  
MAXQ is a registered trademark of Analog Devices, Inc.*

Simplified Block Diagram

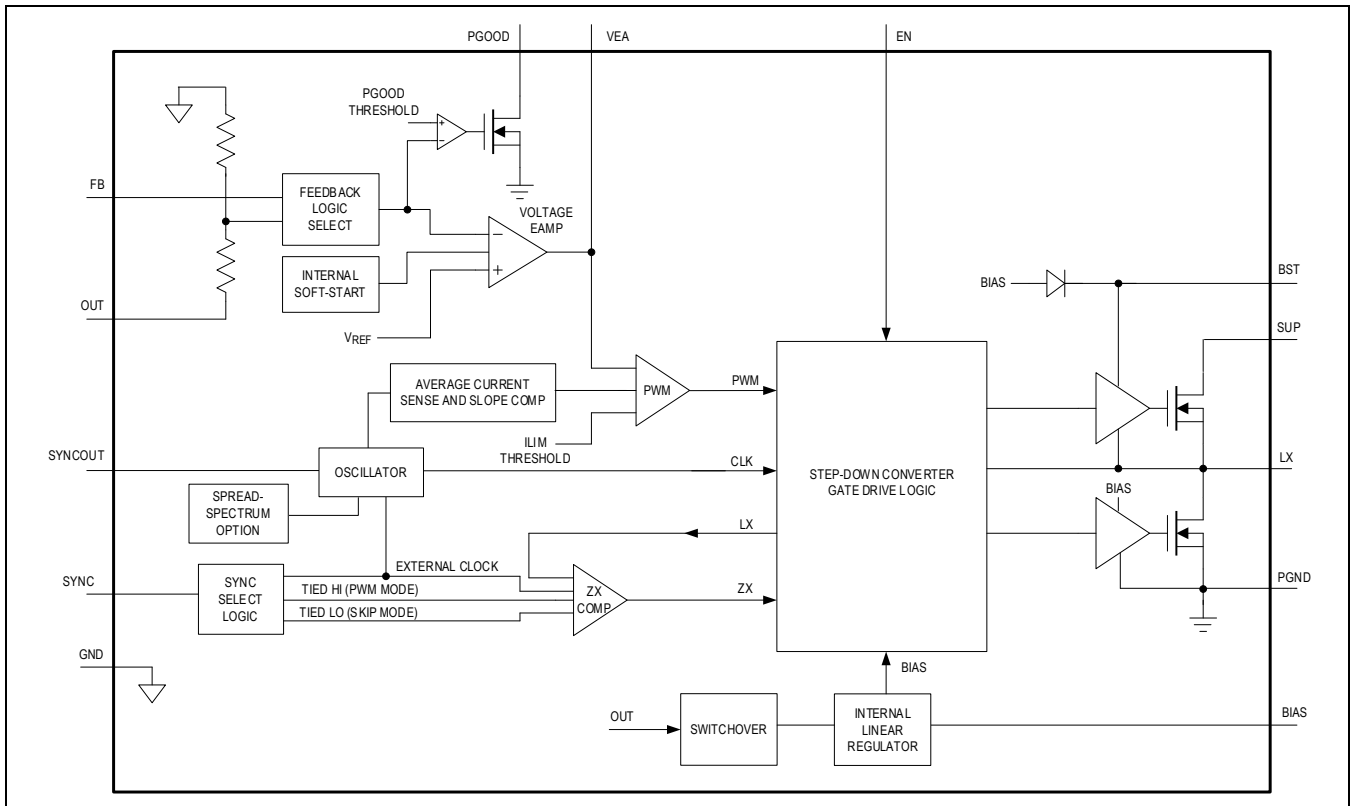

**Absolute Maximum Ratings**

SUP.....	-0.3V to +42V	BIAS.....	-0.3V to +2.2V
EN.....	-0.3V to +42V	PGND to AGND.....	-0.3V to +0.3V
BST to LX ( <a href="#">Note 1</a> ).....	-0.3V to +2.2V	LX Continuous RMS Current.....	6A
BST.....	-0.3V to +44V	ESD Protection	
LX ( <a href="#">Note 1</a> ).....	-0.3V to SUP+0.3V	Human Body Model.....	±2kV
SYNCOUT.....	-0.3V to +6V	Charged Device Model.....	±750V
SYNC.....	-0.3V to +6V	Continuous Power Dissipation (T <sub>A</sub> = +70°C, derate 34.48mW/°C above +70°C.).....	2758mW
VEA.....	-0.3V to BIAS+0.3V	Operating Temperature Range.....	-40°C to +150°C
FB.....	-0.3V to BIAS+0.3V	Storage Temperature Range.....	-65°C to +150°C
OUT.....	-0.3V to +16V	Soldering Temperature (Soldering 10sec).....	+300°C
PGOOD.....	-0.3V to +6V		

**Note 1:** Self-protected against transient voltages exceeding these limits for ≤50ns under normal operation and loads up to the maximum rated output current.

*Stresses beyond those listed under "Absolute Maximum Ratings" may cause permanent damage to the device. These are stress ratings only, and functional operation of the device at these or any other conditions beyond those indicated in the operational sections of the specifications is not implied. Exposure to absolute maximum rating conditions for extended periods may affect device reliability.*

**Recommended Operating Conditions**

PARAMETER	SYMBOL	CONDITION	TYPICAL RANGE	UNIT
Ambient Temperature Range	T <sub>A</sub>		-40 to +125	°C

**Note:** These limits are not guaranteed.

**Package Information**

**17 FC2QFN (MAX20404/MAX20405/MAX20406)**

<b>Package Code</b>	<b>F173A3FY+6</b>	
Outline Number	<a href="#">21-100343</a>	
Land Pattern Number	<a href="#">90-100129</a>	
<b>THERMAL PARAMETERS</b>	<b>JEDEC 4-LAYER BOARD</b>	<b>EV KIT 4-LAYER BOARD</b>
Junction-to-Ambient Thermal Resistance (θ <sub>JA</sub> )	38.4°C/W	28.9°C/W
Junction-to-Case (top) Thermal Resistance (θ <sub>JCT</sub> )	21.4°C/W	—
Junction-to-Case (bottom) Thermal Resistance (θ <sub>JCb</sub> )	10.4°C/W	10.2°C/W
Junction-to-Board Thermal Resistance (θ <sub>JB</sub> )	9.9°C/W	12.0°C/W
Junction-to-Top Characterization Parameter (ψ <sub>JT</sub> )	1.9°C/W	0.86°C/W
Junction-to-Board Characterization Parameter (ψ <sub>JB</sub> )	12.5°C/W	12.2°C/W

**15 FC2QFN (MAX20406E)**

<b>Package Code</b>	<b>F153A3FY+2</b>	
Outline Number	<a href="#">21-100624</a>	
Land Pattern Number	<a href="#">90-100214</a>	
<b>THERMAL PARAMETERS</b>	<b>JEDEC 4-LAYER BOARD</b>	<b>EV KIT 4-LAYER BOARD</b>
Junction-to-Ambient Thermal Resistance (θ <sub>JA</sub> )	37.8°C/W	31.5°C/W

Junction-to-Case (top) Thermal Resistance ( $\theta_{JCt}$ )	24.0°C/W	—
Junction-to-Case (bottom) Thermal Resistance ( $\theta_{JCb}$ )	10.1°C/W	10.3°C/W
Junction-to-Board Thermal Resistance ( $\theta_{JB}$ )	11.9°C/W	12.0°C/W
Junction-to-Top Characterization Parameter ( $\psi_{JT}$ )	1.3°C/W	1.1°C/W
Junction-to-Board Characterization Parameter ( $\psi_{JB}$ )	12.5°C/W	14.0°C/W

For the latest package outline information and land patterns (footprints), go to <https://www.analog.com/en/resources/packaging-quality-symbols-footprints/package-index.html>. Note that a “+”, “#”, or “-” in the package code indicates RoHS status only. Package drawings may show a different suffix character, but the drawing pertains to the package regardless of RoHS status.

Package thermal resistances were obtained using both the four-layer EV kit as well as the method described in JEDEC specification JESD51-7. For detailed information on package thermal considerations, refer to <https://www.analog.com/en/resources/technical-articles/thermal-characterization-of-ic-packages.html>.

## Electrical Characteristics

( $V_{SUP} = V_{EN} = 14V$ ,  $T_J = -40^\circ C$  to  $+150^\circ C$ , unless otherwise noted. Typical values are at  $T_A = +25^\circ C$  under normal conditions unless otherwise noted. [Note 2](#) and [Note 3](#))

PARAMETER	SYMBOL	CONDITIONS	MIN	TYP	MAX	UNITS
Supply Voltage Range	$V_{SUP}$		3		36	V
Supply Current	$I_{SUP\_SHDN}$	$V_{EN} = 0V$ , $T_A = +25^\circ C$		4	6	$\mu A$
	$I_{SUP}$	$V_{EN} = \text{high}$ , $V_{OUT} = 3.3V$ , $V_{FB} = V_{BIAS}$ , no load, no switching, $T_A = +25^\circ C$		10		
SUP Undervoltage Lockout	$V_{SUP\_UVLO\_R\_ISE}$	SUP voltage rising	2.945	3.025	3.175	V
	$V_{SUP\_UVLO\_F\_ALL}$	SUP voltage falling	2.655	2.725	2.870	
BIAS Undervoltage Lockout	$V_{BIAS\_UVLO}$	BIAS voltage falling	1.53	1.58	1.63	V
BIAS Undervoltage Lock	$V_{BIAS\_UVLO\_HYS}$	BIAS UVLO hysteresis		50		mV
BIAS Voltage	$V_{BIAS}$			1.8		V
<b>BUCK CONVERTER</b>						
Output Voltage Accuracy	$V_{OUT\_5V}$	Skip mode, no load	4.93	5.0	5.05	V
		PWM mode, no load	4.95	5.0	5.05	
	$V_{OUT\_4.2V}$	Skip mode, no load	4.13	4.2	4.245	
		PWM mode, no load	4.155	4.2	4.245	
	$V_{OUT\_3.9V}$	Skip mode, no load	3.84	3.9	3.94	
		PWM mode, no load	3.86	3.9	3.94	
$V_{OUT\_3.3V}$	Skip mode, no load	3.245	3.3	3.335		
	PWM mode, no load	3.265	3.3	3.335		
Output Voltage Adjustable Range	$V_{OUT}$		0.8		10	V
Feedback Voltage Accuracy	$V_{FB\_PWM}$	PWM mode, no load	0.787	0.800	0.813	V
Feedback Leakage Current	$I_{FB}$	$V_{FB} = 0.8V$ , $T_A = +25^\circ C$			100	nA
High-Side DMOS On-Resistance	$R_{DSON\_HS}$	$V_{BIAS} = 1.8V$ , $I_{LX} = 2A$		45	90	m $\Omega$
Low-Side DMOS On-Resistance	$R_{DSON\_LS}$	$V_{BIAS} = 1.8V$ , $I_{LX} = 2A$		22	44	m $\Omega$

( $V_{SUP} = V_{EN} = 14V$ ,  $T_J = -40^{\circ}C$  to  $+150^{\circ}C$ , unless otherwise noted. Typical values are at  $T_A = +25^{\circ}C$  under normal conditions unless otherwise noted. [Note 2](#) and [Note 3](#))

PARAMETER	SYMBOL	CONDITIONS	MIN	TYP	MAX	UNITS
High-Side DMOS Current-Limit Threshold	$I_{LIM}$	MAX20404	5.50	6.25	7.00	A
		MAX20405	6.5	7.5	8.5	
		MAX20406/MAX20406E	7.5	8.75	10	
Low-Side DMOS Negative Current-Limit Threshold	$I_{NEG}$	MAX20404		-2.3		A
		MAX20405		-3		
		MAX20406/MAX20406E		-3.5		
LX Leakage	$I_{LX\_LKG}$	$V_{SUP} = 36V$ , $V_{LX} = 0V$ , or $V_{LX} = 36V$ , $T_A = +25^{\circ}C$			1	$\mu A$
Soft-Start Ramp Time	$t_{SS}$		2.2		2.8	ms
Minimum On-Time	$t_{ON}$	<a href="#">(Note 4)</a>		33	55	ns
Maximum Duty Cycle	$D_{MAX}$	Dropout mode	98	99		%
<b>SWITCHING FREQUENCY</b>						
PWM Switching Frequency	$f_{SW}$	400kHz	360	400	440	kHz
		2.1MHz	1.925	2.1	2.275	
		2.3MHz	2.0	2.3	2.6	MHz
		3.0MHz	2.7	3.0	3.3	
SYNC External Clock Frequency	$f_{SYNC}$	$f_{SW} = 400kHz$	360		600	kHz
		$f_{SW} = 2.1MHz$	1.7		2.6	
		$f_{SW} = 2.3MHz$	2.0		2.6	MHz
		$f_{SW} = 3MHz$	2.6		3.4	
Spread Spectrum	SPS	Percentage of $f_{SW}$		$\pm 3$		%
<b>PGOOD OUTPUT</b>						
PGOOD Threshold	$V_{PGOOD\_THR}$	$V_{OUT}$ rising	92	94	96	%
	$V_{PGOOD\_THF}$	$V_{OUT}$ falling	91	93	95	
PGOOD Debounce Time	$t_{DEB}$	Rising		100		$\mu s$
		Falling		50		
PGOOD Leakage Current	$I_{PGOOD\_LKG}$	$T_A = +25^{\circ}C$			1	$\mu A$
PGOOD Low Voltage Level	$V_{PGOOD\_LOW}$	Sinking 1mA			0.4	V
<b>LOGIC LEVELS</b>						
EN High Voltage Level	$V_{EN\_HIGH}$		1.2			V
EN Low Voltage Level	$V_{EN\_LOW}$				0.5	V
EN Input Current	$I_{EN}$	$V_{EN} = V_{SUP} = 36V$ , $T_A = +25^{\circ}C$			1	$\mu A$
SYNC High Voltage Level	$V_{SYNC\_HIGH}$		1.4			V
SYNC Low Voltage Level	$V_{SYNC\_LOW}$				0.4	V
SYNCOUT Output Voltage Level	$V_{SYNCOUT}$	No load	2.6	3.3	3.9	V
<b>THERMAL PROTECTION</b>						
Thermal Shutdown	$T_{SHDN}$			175		$^{\circ}C$

( $V_{SUP} = V_{EN} = 14V$ ,  $T_J = -40^{\circ}C$  to  $+150^{\circ}C$ , unless otherwise noted. Typical values are at  $T_A = +25^{\circ}C$  under normal conditions unless otherwise noted. [Note 2](#) and [Note 3](#))

PARAMETER	SYMBOL	CONDITIONS	MIN	TYP	MAX	UNITS
Thermal Shutdown Hysteresis	$T_{SHDN\_HYS}$			20		$^{\circ}C$

**Note 2:** Limits are 100% tested at  $T_A = +25^{\circ}C$ . Limits over the operating temperature range and relevant supply voltage are guaranteed by design and characterization. Typical values are at  $T_A = +25^{\circ}C$ .

**Note 3:** The device is designed for continuous operation up to  $T_J = +125^{\circ}C$  for 95,000 hours and  $T_J = +150^{\circ}C$  for 5,000 hours.

**Note 4:** Guaranteed by design; not production tested.

Typical Operating Characteristics

( $V_{SUP} = V_{EN} = +14V$ ,  $T_A = +25^{\circ}C$ , unless otherwise noted.)

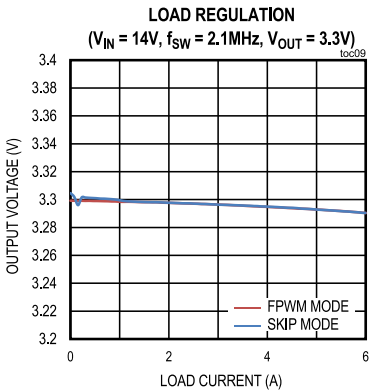
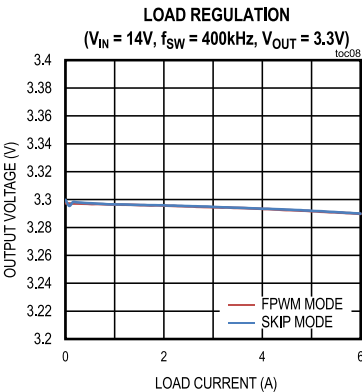
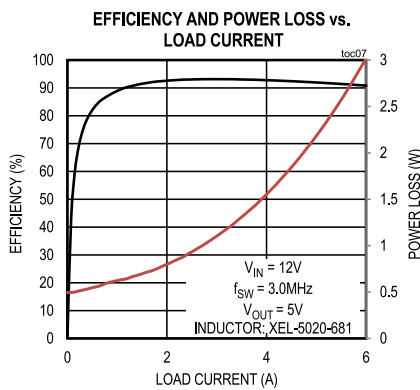
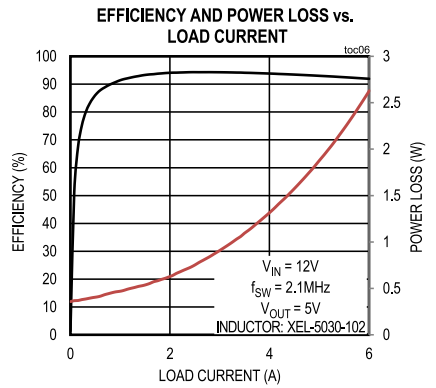
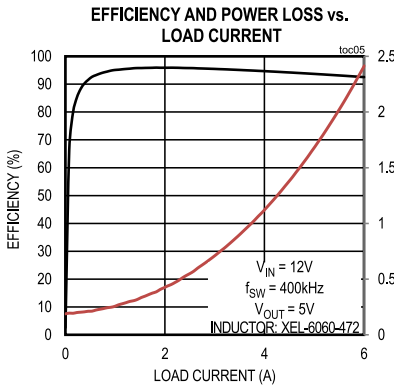
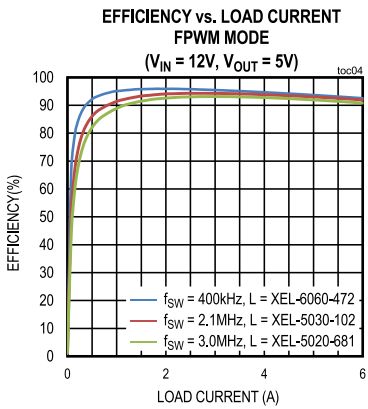
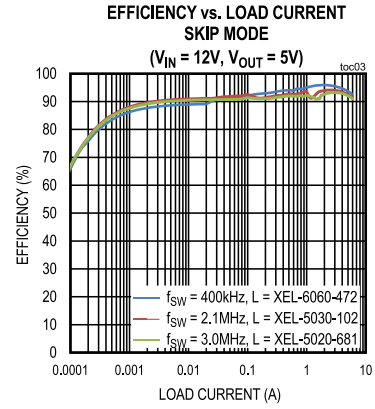
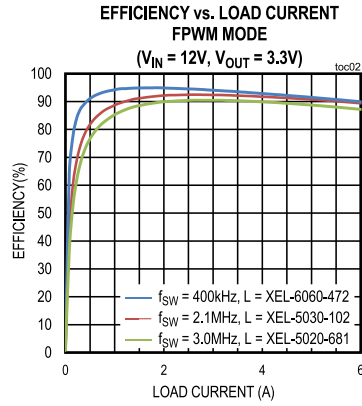
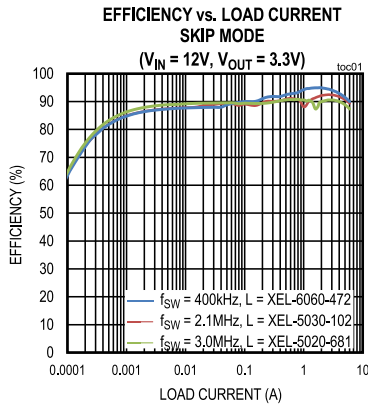

( $V_{SUP} = V_{EN} = +14V$ ,  $T_A = +25^\circ C$ , unless otherwise noted.)

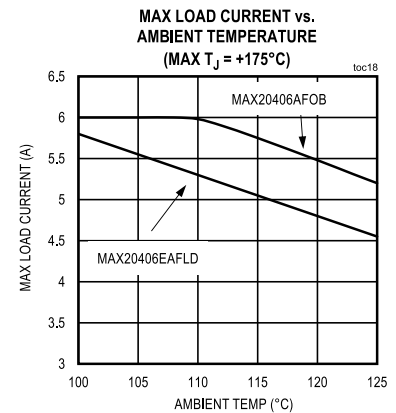
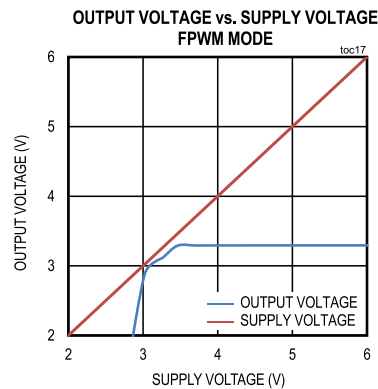
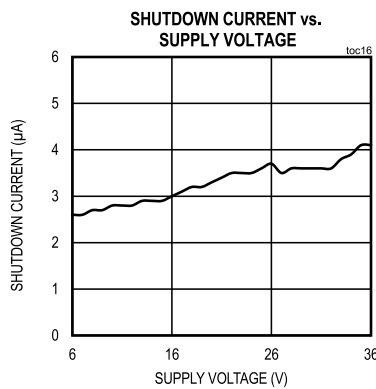
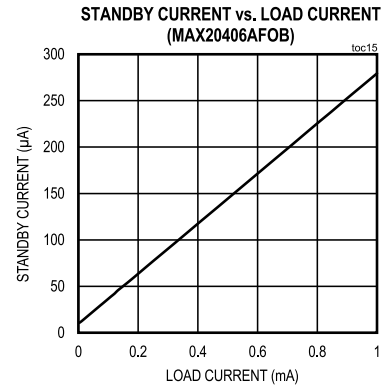
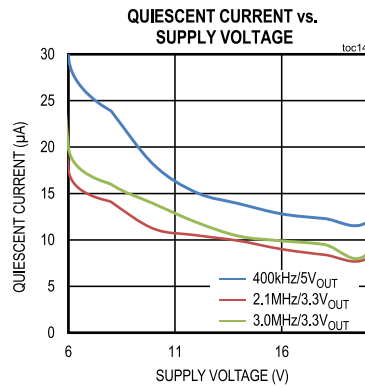
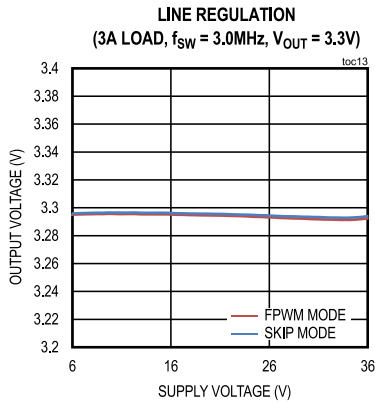
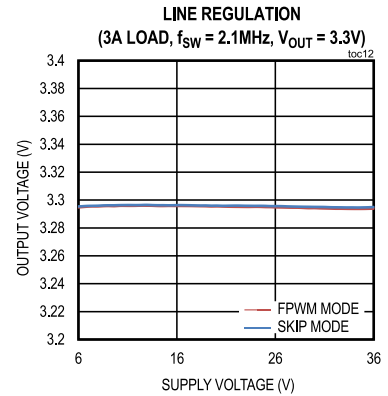
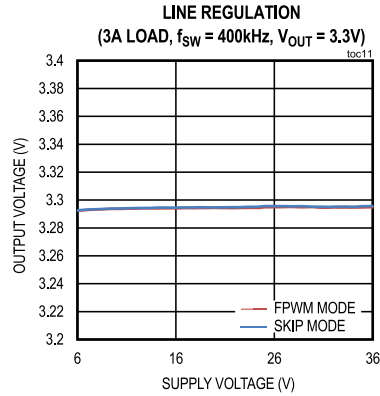
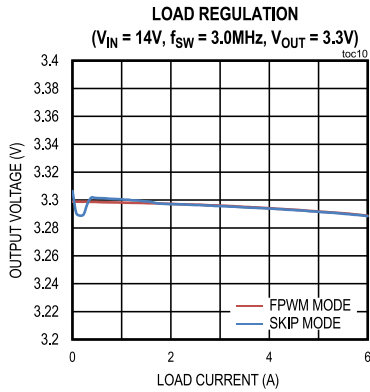

( $V_{SUP} = V_{EN} = +14V$ ,  $T_A = +25^\circ C$ , unless otherwise noted.)

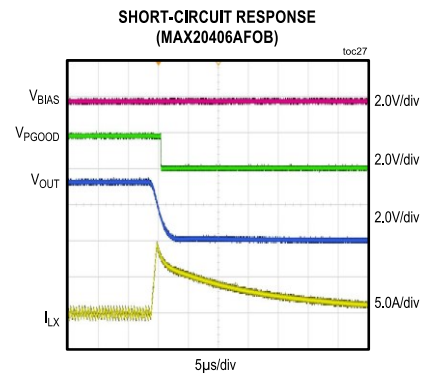
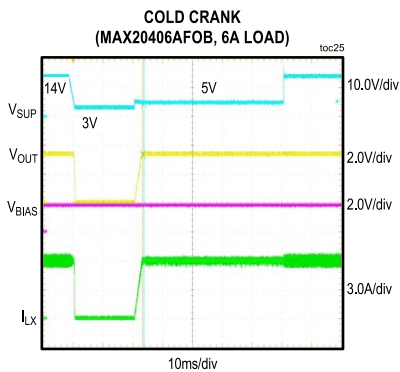
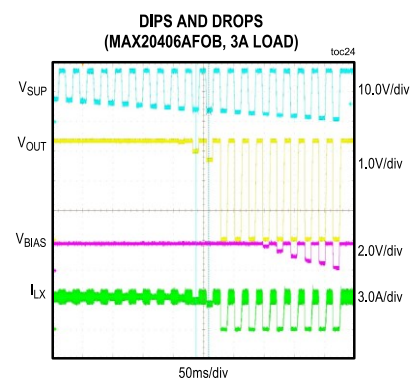
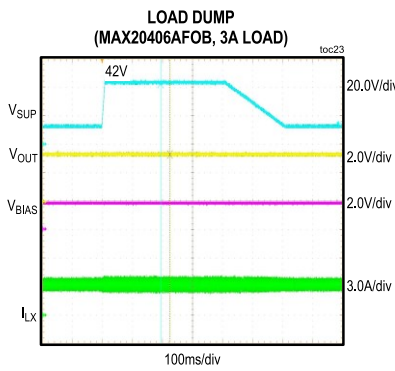
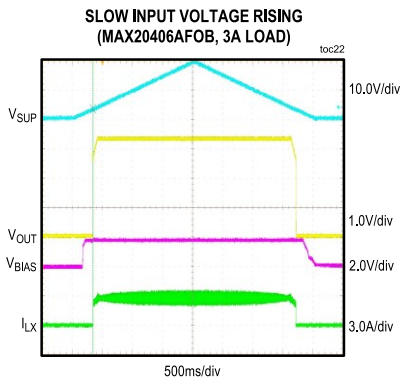
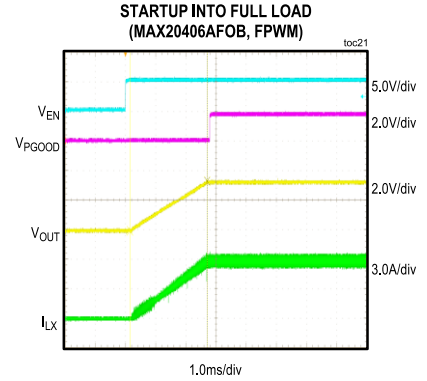
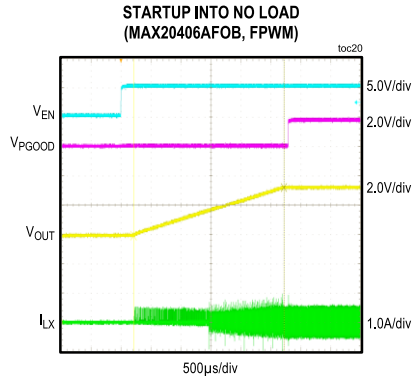
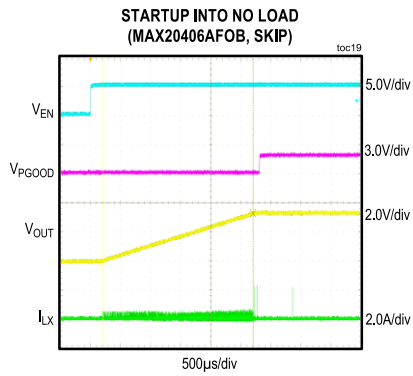

( $V_{SUP} = V_{EN} = +14V$ ,  $T_A = +25^\circ C$ , unless otherwise noted.)

**HICCUP MODE  
(MAX20406AFOB)**

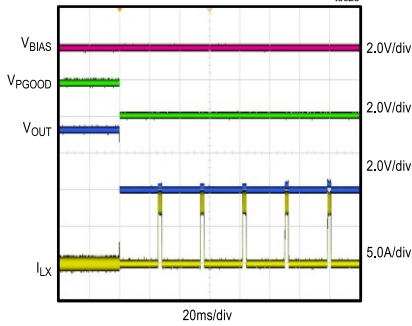

**MINIMUM ON-TIME  
(MAX20406AFOB, FPWM)  
(VIN = 33V, NO LOAD)**

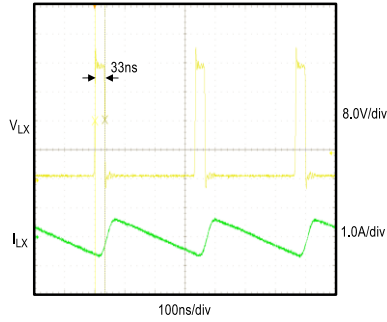

**SKIP MODE, NO LOAD OPERATION  
(MAX20406AFOB)**

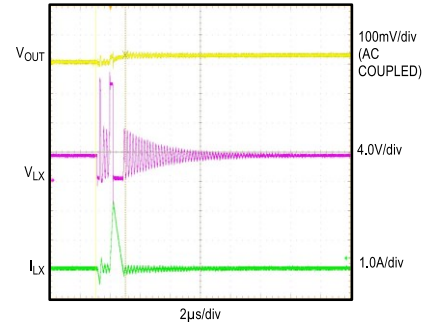

**DUAL-PHASE LOAD TRANSIENT  
(MAX20406AFOB)**

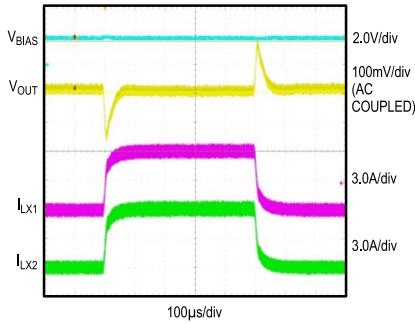

**DUAL-PHASE CURRENT SHARING  
(MAX20406AFOB)**

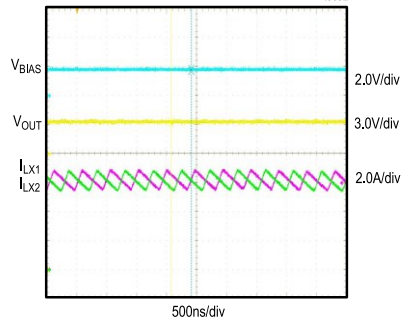

**STEADY-STATE SWITCHING WAVEFORM  
(MAX20406AFOB)**

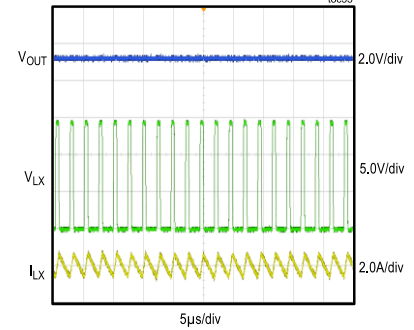

**CONDUCTED EMI PERFORMANCE  
(CISPR25 WITH CLASS 5 PEAK LIMITS)**

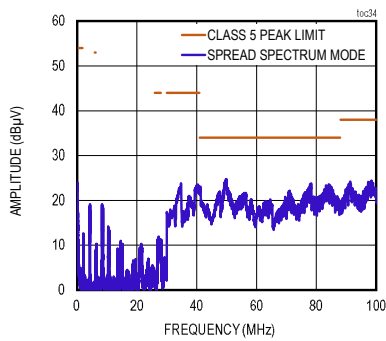

**RADIATED EMI PERFORMANCE  
(CISPR25 WITH CLASS 5 PEAK LIMITS)  
VERTICAL ANTENNA**

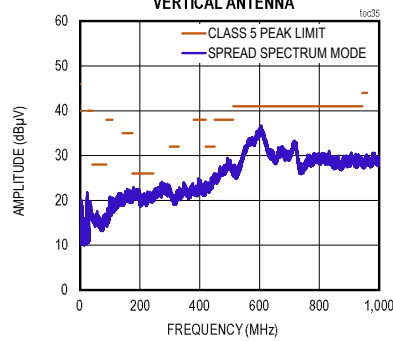

**RADIATED EMI PERFORMANCE  
(CISPR25 WITH CLASS 5 PEAK LIMITS)  
HORIZONTAL ANTENNA**

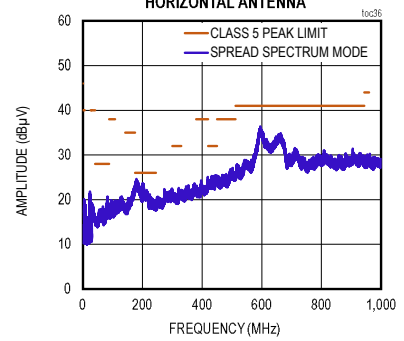

### Pin Configurations

#### MAX20404/MAX20405/MAX20406

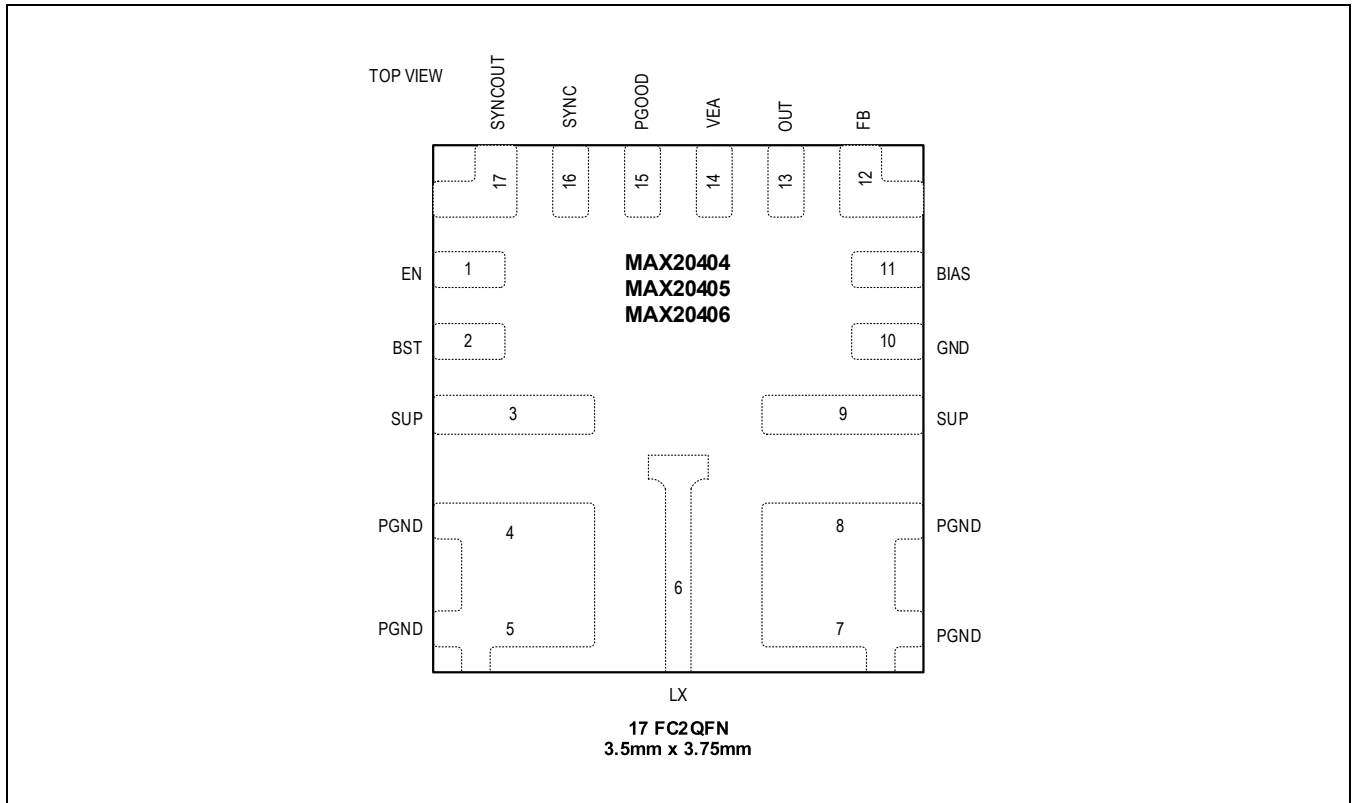

MAX20406E

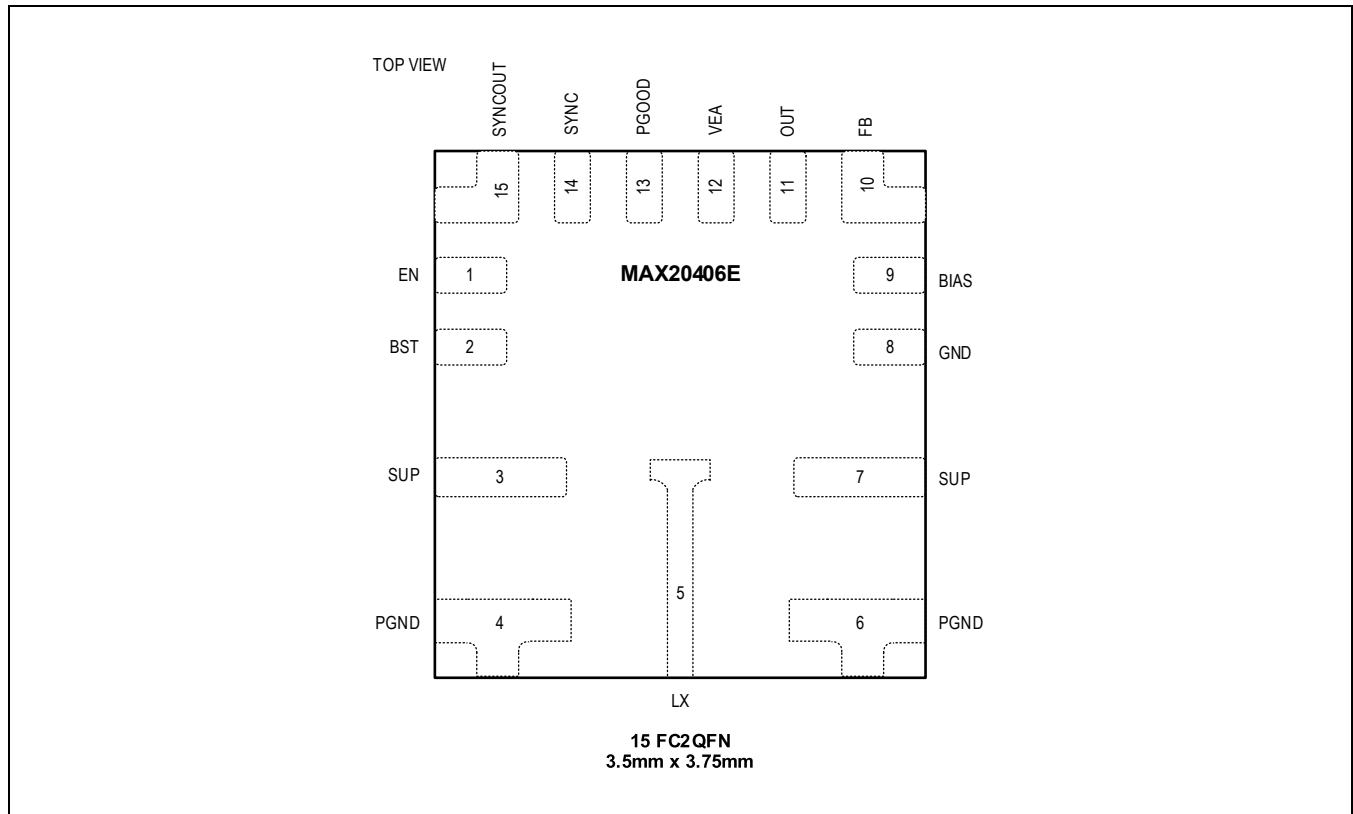

Pin Descriptions

PIN		NAME	FUNCTION
MAX20404/ MAX20405/ MAX20406	MAX20406E		
1	1	EN	High-Voltage-Compatible Input for Circuit Activation. If this pin is low, the part is off.
2	2	BST	High-Side Driver Supply. Connect a 0.1µF capacitor between LX and BST for proper operation.
3,9	3,7	SUP	IC Supply Input. Connect a 1µF or larger ceramic capacitor in parallel with a 4.7µF capacitor from SUP to PGND.
4,5,7,8	4,6	PGND	Power Ground. Connect all PGND pins together.
6	5	LX	BUCK Switching Node. High impedance when part is off. Connect LX to the switched side of the appropriate inductor.
10	8	GND	Analog Ground
11	9	BIAS	1.8V Internal BIAS Supply. Connect a minimum of 2µF ceramic capacitor to PGND.
12	10	FB	Feedback Pin. Connect a resistor-divider from OUT to FB to GND for external adjustment of output voltage. Connect to BIAS for internal fixed voltages.
13	11	OUT	Buck Regulator Output Voltage-Sense Input. Connect OUT to the buck output.
14	12	VEA	Internal Voltage Loop Error-Amplifier Output. Connect to VEA of the target for dual-phase operation. Leave unconnected for single-phase operation.
15	13	PGOOD	Open-Drain Reset Output. External pull-up required.
16	14	SYNC	SYNC. If connected to GND, Skip-mode operation is enabled under light loads. If connected to BIAS, forced-PWM mode is enabled.

17	15	SYNCOU	180-Degree Out-of-Phase Clock Output for Multiphase Operation. Leave SYNCOU open for single-phase operation.
----	----	--------	--

## Detailed Description

The MAX20404/MAX20405/MAX20406/MAX20406E are small, synchronous buck converters with integrated high-side and low-side switches. These devices are designed to deliver up to 6A with input voltages from +3V to +36V while using only 10 $\mu$ A quiescent current at no load ( $V_{SUP} = 12V$ ,  $V_{OUT} = 3.3V$ ). Voltage quality can be monitored by observing the PGOOD signal. The ICs can operate in dropout by running at 99% duty cycle, making them ideal for automotive and industrial applications.

The MAX20404/MAX20405/MAX20406/MAX20406E offer fixed output voltages (see the [Ordering Information](#) table) or an FB pin for an external resistor-divider. The frequency is internally fixed at 2.1MHz, 2.3MHz, 3MHz, or 400kHz, which allows for small external components and reduced output ripple, and guarantees no AM interference. The device automatically enters skip mode (SYNC pin pulled low) at light loads with an ultra-low-quiescent current of 10 $\mu$ A at no load. It can be ordered with spread-spectrum frequency modulation designed to minimize EMI-radiated emissions due to the modulation frequency. The architecture is an average current-mode control that allows much better noise rejection of the current loop. The IC comes with a small minimum ON time of 33ns to allow for large step-down ratios in single stage without skipping cycles.

The devices can also be used in a dual-phase configuration with the help of SYNCOUT and VEA. An innovative average current-mode control architecture provides noise immunity and accurate dynamic current sharing during transients. Highpower designs with up to 12A of output current can be enabled with integrated switches using the IC's dual-phase capability. FC2QFN provides improved thermal and EMI performance. Symmetrical pinout across VIN and PGND further improves the EMI performance, enabling low-noise designs.

## Multiphase Operation

The MAX20404/MAX20405/MAX20406/MAX20406E are capable of dual-phase operation for high-current applications, and each IC can be configured as a controller or a target. The multiphase operation is intended for forced-PWM mode only. SYNCOUT will be 180 degrees out of phase with the controller clock. If the device is in Skip mode, then no clock will be present on SYNCOUT. To enable low- $I_Q$  operation in dual-phase configuration, disable the EN of the target to turn OFF the IC and save quiescent current.

For a target, connect SYNCOUT to BIAS. When EN is high, there will be a procedure to detect if the IC is a controller (SYNCOUT not connected to BIAS) or a target. The VEA pin will be the voltage-error amplifier output for the controller or the current-error amplifier input for the target. Connect the VEA pin of the controller to the VEA pin of the target to ensure balanced current sharing between two phases. FB of the controller and target should be connected to their respective BIAS pins for internal fixed  $V_{OUT}$  setting. Since the target IC uses the outer voltage loop of the controller (through the VEA pin), the internal resistor-divider of the target IC is not used, and any mismatch in the output voltage is avoided. See [Figure 1](#) for a dual-phase configuration setup using the MAX20404/MAX20405/MAX20406/MAX20406E.

For external resistor-divider configurations, use two separate resistor-dividers for each IC to avoid the FB pins of controller and target being connected together at the same point.

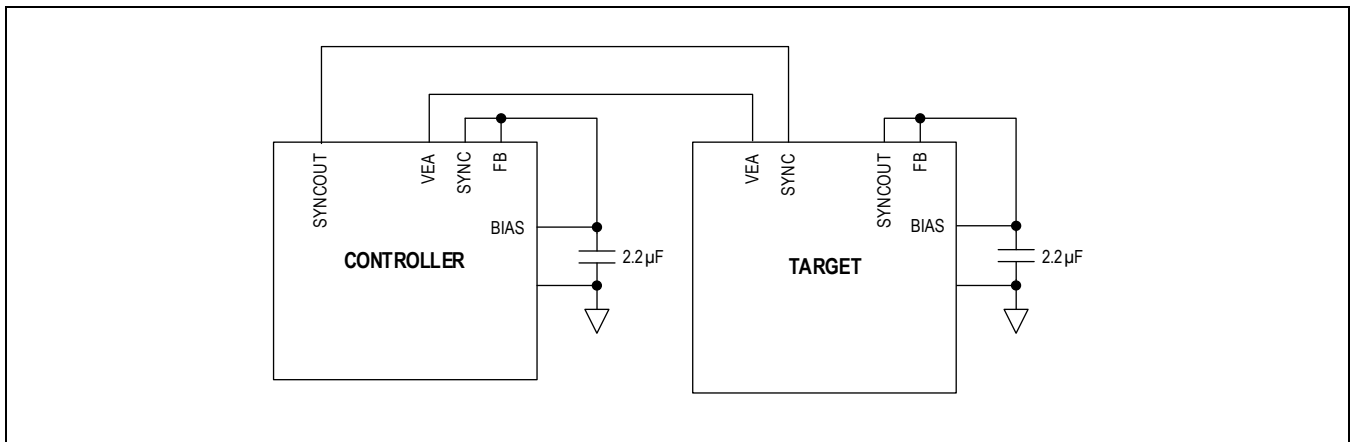

Figure 1. Typical Dual-Phase Configuration Setup Using Fixed Internal  $V_{OUT}$  Setting

### Linear Regulator Output (BIAS)

The device includes a 1.8V linear regulator ( $V_{BIAS}$ ) that provides power to the internal circuit blocks. Connect a 2.2 $\mu$ F ceramic capacitor from BIAS to GND. During startup, the bias regulator draws power from the input and switches over to the output after the startup is complete (if  $V_{OUT} > 2.5V$ ). For output voltages less than 1.8V, the bias regulator is always tied to the input.

### System Enable (EN)

An enable control input (EN) activates the devices from their low-power shutdown mode. EN is compatible with inputs from automotive battery level down to 3V. EN turns on the internal linear (BIAS) regulator. Once  $V_{BIAS}$  is above the internal lockout threshold ( $V_{UVBIAS} = 1.63V$  (typ)), the converter activates and the output voltage ramps up with the programmed soft-start time.

A logic-low at EN shuts down the device. During shutdown, the BIAS regulator and gate drivers turn off. Shutdown is the lowest power state and reduces the quiescent current to 4 $\mu$ A (typ). Drive EN high to bring the device out of shutdown.

### Synchronization Input (SYNC)

The MAX20404/MAX20405/MAX20406/MAX20406E include a SYNC pin, which is a logic-level input used for operating-mode selection and frequency control. Connecting SYNC to BIAS or to an external clock enables forced fixed-frequency (FPWM) operation. Connecting SYNC to GND enables automatic skip-mode operation for better light-load efficiency. The ICs synchronize to an external clock at the rising edge applied at the SYNC pin. The devices synchronize to the external clock in two cycles. When the external clock signal at SYNC is absent for more than two clock cycles, the devices use the internal clock.

### Soft-Start

The devices include a fixed, internal 2.5ms soft-start. Soft-start limits startup inrush current by forcing the output voltage to ramp up towards its regulation point.

### Spread-Spectrum Option

The ICs feature enhanced EMI performance with a spread-spectrum option, which is available as a factory option. When spread spectrum is enabled, the operating frequency is varied at  $\pm 3\%$  centered at the switching frequency. The modulation signal is a triangular wave with 4.5kHz frequency at 2.1MHz. Therefore, the switching frequency ramps down 3% and back to 2.1MHz in 110 $\mu$ s, and also ramps up 3% and back to 2.1MHz in 110 $\mu$ s after which the cycle repeats. For operation at 400kHz, the modulation signal scales proportionally to 0.4/2.1. The internal spread spectrum is disabled if the devices are synchronized to an external clock. However, the devices do not filter the input clock in SYNC and pass any modulation (including spread spectrum) present on the driving external clock.

### Short-Circuit Protection

The devices feature a current limit that protects them against short-circuit and overload conditions at the output. In the event of a short-circuit or overload condition, the high-side MOSFET remains on until the inductor current reaches the specified LX current-limit threshold. The converter then turns the high-side MOSFET off and the low-side MOSFET on to allow the inductor current to ramp down. Once the inductor current crosses below the current-limit threshold, the converter turns on the high-side MOSFET again. This cycle repeats until the short or overload condition is removed.

A hard short is detected when the output voltage falls below 50% of the target (for fixed internal output) or 25% of the target (for external output) while in current limit. If this occurs, hiccup mode activates, and the output turns off for 25ms. The output then enters soft-start and powers back up. This repeats indefinitely while the short circuit is present. Hiccup mode is disabled during soft-start.

## Applications Information

### Setting the Output Voltage

Connect FB to BIAS for a fixed 5V or 3.3V output voltage. To set the output to other voltages between 0.8V and 10V, connect a resistor-divider from the output (OUT) to GND [Figure 2](#). Select R<sub>FB2</sub> (FB to GND resistor) less than or equal to 100kΩ. Calculate R<sub>FB1</sub> (OUT to FB resistor) with the following equation:

Equation 1:

$$R_{FB1} = R_{FB2} \cdot \left( \frac{V_{OUT}}{V_{FB}} - 1 \right)$$

where V<sub>FB</sub> is the feedback regulation voltage. See the [Electrical Characteristics](#) table.

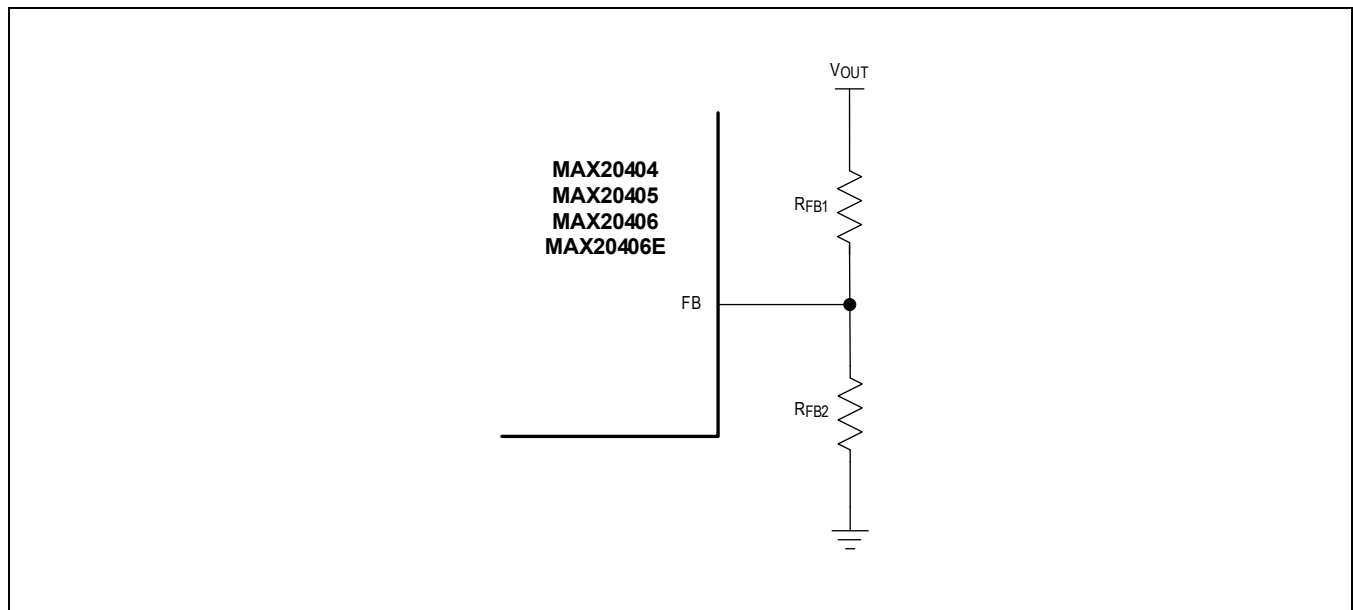

Figure 2. Output Voltage Setting Using External Resistor-Divider

[Table 1](#) provides components selection recommendations for each output range for the adjustable-output configuration. Recommendations can be further optimized for specific applications. The CFF values listed in [Table 1](#) are recommended based on R<sub>FB1</sub> = 100kΩ. The CFF recommendation changes with the R<sub>FB1</sub> selection.

**Table 1. Recommended Components for Adjustable Output Voltage**

SWITCHING FREQUENCY (kHz)	V <sub>OUT</sub> (V)	INDUCTOR (μH)	EFFECTIVE C <sub>OUT</sub> (μF)	CFF (pF)
400	0.8 to 1.8	1.5	440	100
	1.8 to 3	3.3	440	100
	3 to 5	3.3	150	47
	5 to 10	4.7	90	100
2100, 2300	0.8 to 3	0.56	235	10
	3 to 5	1	44	15
	5 to 10	1	44	27
2100 Low C <sub>OUT</sub> Option	0.8 to 3	0.56	141	10
	3 to 5	1	40	15
	5 to 10	1	22	27
3000	0.8 to 3	0.47	141	15
	3 to 5	0.68	30	20
	5 to 10	0.9	30	27

## Dual-Phase Operation

### Low-I<sub>Q</sub> Operation in Dual Phase

The MAX20404/MAX20405/MAX20406/MAX20406E come with dual-phase capability where each IC can be either configured as a controller or target. The SYNCOUT pin of the controller outputs a 180-degree out-of-phase clock when SYNC is tied high (FPWM mode). For low-I<sub>Q</sub> mode, the SYNC pin of the controller should be pulled low (Skip mode). In this mode, there is no clock present on SYNCOUT pin of the controller, and the controller IC enters Skip mode. The internal circuit of the target IC remains ON during this time and actively looks for the SYNCOUT signal from the controller. Since the target IC is ON, the quiescent current is slightly higher, even though both of the ICs skip pulses.

To improve the light-load efficiency and further reduce the I<sub>Q</sub>, the target EN should be pulled low. This disables the target and its internal circuits, further reducing the I<sub>Q</sub>. [Table 2](#) summarizes the truth table for low-I<sub>Q</sub> operation.

**Table 2. Configurations for Low-I<sub>Q</sub> Operation**

CONTROLLER	TARGET	MODE
EN = High, SYNC = BIAS	EN = High	FPWM (high I <sub>Q</sub> )
EN = High, SYNC = Low	EN = High	Skip mode (low I <sub>Q</sub> )
EN = High, SYNC = Low	EN = Low	Standby mode (ultra-low I <sub>Q</sub> )
EN = Low	EN = High	Not allowed

### Setting Output Voltage

For setting the output voltage to internal fixed voltage, order the same fixed V<sub>OUT</sub> setting for both controller and target ICs and connect the FB pin to its respective BIAS. It is recommended NOT to connect the FB pins of the controller and target together.

For setting the output voltage to a value other than the available fixed V<sub>OUT</sub> options, connect a resistor-divider between OUT, FB, and GND as shown in [Figure 3](#). An identical but separate resistor-divider for controller and target is recommended.

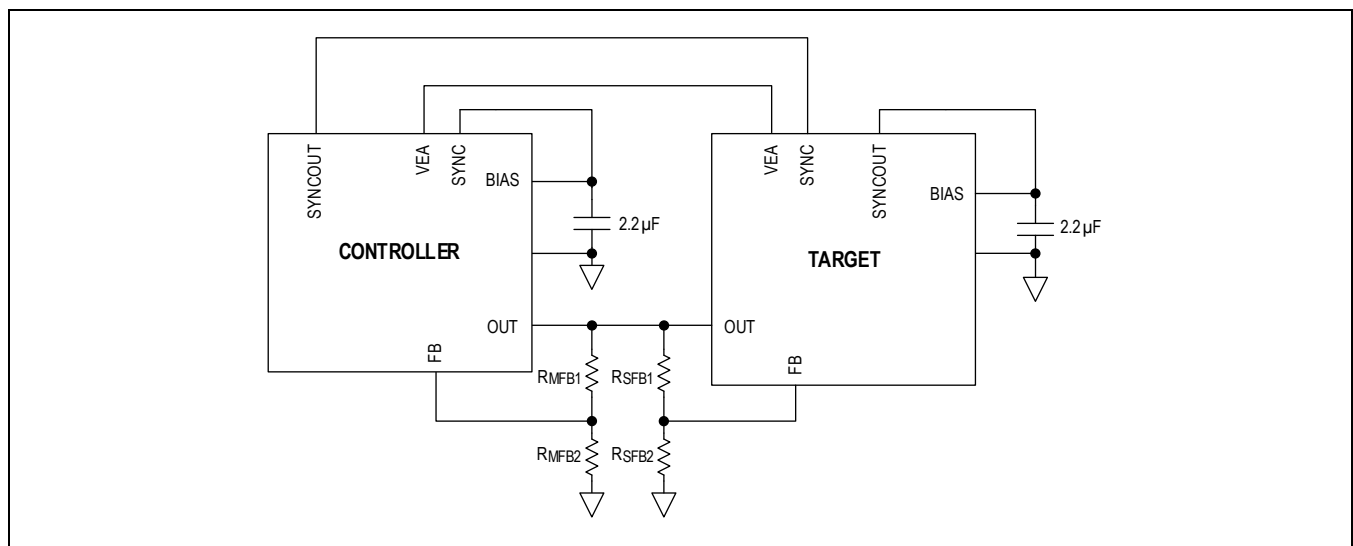

*Figure 3. Typical Application Circuit for Dual-Phase Configuration with External Resistor-Divider*

### Inductor Selection

Inductor design is a compromise between the size, efficiency, control-loop bandwidth, and stability of the converter. Insufficient inductance value would increase the inductor current ripple, causing higher conduction losses and higher output voltage ripple. Since the slope compensation is fixed internally for the MAX20404/MAX20405/MAX20406/MAX20406E, it might also cause current-mode-control instability to appear. A large inductor reduces the ripple, but

increases the size and cost of the solution and slows the response. [Table 3](#) provides optimized inductance values for each switching frequency. The nominal standard value selected should be within  $\pm 30\%$  of the specified inductance.

**Table 3. Inductor Selection for Fixed Output Voltage**

SWITCHING FREQUENCY	INDUCTOR_TYP ( $\mu\text{H}$ )
400kHz	4.7
2.1MHz, 2.3MHz	1
3.0MHz	0.68

### Input Capacitor

The input filter capacitor reduces peak currents drawn from the power source and reduces noise and voltage ripple on the input caused by the circuit's switching. The MAX20404/MAX20405/MAX20406/MAX20406E incorporate a symmetrical pinout that can be leveraged for better EMI performance. Connect two high-frequency 0603 or smaller capacitors on two SUP pins on either side of the package for good EMI performance. Connect a high-quality,  $4.7\mu\text{F}$  (or larger) low-ESR ceramic capacitor on the SUP pin for low-input voltage ripple.

A bulk capacitor with higher ESR (such as an electrolytic capacitor) is normally required as well to lower the Q of the front-end circuit and provide the remaining capacitance needed to minimize input-voltage ripple. The input capacitor RMS current requirement ( $I_{\text{RMS}}$ ) is defined by the following equation:

Equation 2:

$$I_{\text{RMS}} = I_{\text{LOAD(MAX)}} \cdot \left( \frac{\sqrt{V_{\text{OUT}} \cdot (V_{\text{SUP}} - V_{\text{OUT}})}}{V_{\text{SUP}}} \right)$$

$I_{\text{RMS}}$  has a maximum value when the input voltage equals twice the output voltage:

$$V_{\text{SUP}} = 2 \times V_{\text{OUT}}$$

Therefore:

$$I_{\text{RMS}} = \frac{I_{\text{LOAD(MAX)}}}{2}$$

Choose an input capacitor that exhibits less than  $+10^\circ\text{C}$  self-heating temperature rise at the RMS input current for optimal long-term reliability. The input-voltage ripple consists of  $\Delta V_{\text{Q}}$  (caused by the capacitor discharge) and  $\Delta V_{\text{ESR}}$  (caused by the ESR of the capacitor). Use low-ESR ceramic capacitors with high ripple-current capability at the input. Assume the contribution from the ESR and capacitor discharge equal to 50%. Calculate the input capacitance and ESR required for a specified input voltage ripple using the following equations:

Equation 3:

$$\text{ESR}_{\text{IN}} = \frac{\Delta V_{\text{ESR}}}{I_{\text{OUT}} + \Delta I_{\text{L}}/2}$$

where:

$$\Delta I_{\text{L}} = \frac{(V_{\text{SUP}} - V_{\text{OUT}}) \cdot V_{\text{OUT}}}{V_{\text{SUP}} \cdot f_{\text{SW}} \cdot L}$$

and:

$$C_{\text{IN}} = \frac{I_{\text{OUT}} \cdot D(1 - D)}{\Delta V_{\text{Q}} \cdot f_{\text{SW}}}$$

$$D = \frac{V_{\text{OUT}}}{V_{\text{SUP}}}$$

where:

$I_{\text{OUT}}$  = maximum output current

D = duty cycle

## Output Capacitor

Output capacitance is selected to satisfy the output load-transient, output voltage ripple, and closed-loop stability requirements. During a load step, the output current changes almost instantaneously, whereas the inductor is slow to react. During this transition time, the load-current requirements are supplied by the output capacitor, which causes an undershoot/overshoot in the output voltage. For a buck converter that is controlled by inductor current, as employed in the MAX20404/MAX20405/MAX20406/MAX20406E, output capacitance also affects the control-loop stability. The output ripple is composed of  $\Delta V_Q$  (caused by the capacitor discharge) and  $\Delta V_{ESR}$  (caused by the ESR of the output capacitor). Use low-ESR ceramic or aluminum electrolytic capacitors at the output. For aluminum electrolytic capacitors, the entire output ripple is contributed by  $\Delta V_{ESR}$ . Use Equation 4 to calculate the ESR requirement and choose the capacitor accordingly. If using ceramic capacitors, assume the contribution to the output-ripple voltage from the ESR and the capacitor discharge to be equal. The following equations show the output capacitance and ESR requirement for specified output-voltage ripple.

Equation 4:

$$ESR = \frac{\Delta V_{ESR}}{\Delta I_{P-P}}$$

$$C_{OUT} = \frac{\Delta I_{P-P}}{8 \cdot \Delta V_Q \cdot f_{SW}}$$

where:

$$\Delta I_{P-P} = \frac{(V_{IN} - V_{OUT}) \cdot V_{OUT}}{V_{IN} \cdot f_{SW} \cdot L}$$

$$V_{OUT\_RIPPLE} = \Delta V_{ESR} + \Delta V_Q$$

$\Delta I_{P-P}$  is the peak-to-peak inductor current as calculated above, and  $f_{SW}$  is the converter's switching frequency.

The output capacitor supplies the step-load current until the converter responds with a greater duty cycle. The resistive drop across the output capacitor's ESR and the capacitor discharge causes a voltage droop during a step load. Use a combination of low-ESR tantalum and ceramic capacitors for better transient-load and ripple/noise performance. Keep the maximum output-voltage deviations below the tolerable limits of the electronics being powered. When using a ceramic capacitor, assume an 80% and 20% contribution from the output-capacitance discharge and the ESR drop, respectively. Use the following equations to calculate the required ESR and capacitance value:

Equation 5:

$$C_{OUT} = \frac{\Delta I}{\Delta V \cdot 2\pi \cdot f_C}$$

where  $\Delta I$  is the load change,  $\Delta V$  is the allowed voltage droop, and  $f_C$  is the loop crossover frequency, which can be assumed to be the lesser of  $f_{SW}/10$  or 100kHz. Any calculations involving  $C_{OUT}$  should consider capacitance tolerance, temperature, and voltage derating. The values in [Table 4](#) are actual capacitances after considering these factors.

For optimal phase margin, the recommended output capacitances are shown in [Table 4](#). Recommendations can be further optimized for specific applications. If a lower or higher output capacitance is required for the application, contact the factory for an optimized solution.

**Table 4. Output Capacitance Selection – Fixed Output Voltage**

FREQUENCY	EFFECTIVE $C_{OUT}$ TYP ( $\mu F$ )	EFFECTIVE $C_{OUT}$ MIN ( $\mu F$ )
400kHz	100	90
2.1MHz, 2.3MHz	50	42
2.1MHz Low $C_{OUT}$ Option	36	30
3.0MHz	30	20

## PCB Layout Guidelines

Careful PCB layout is critical to achieve low switching losses and clean, stable operation. Use a multilayer board whenever possible for better noise immunity and power dissipation. See [Figure 4](#) and the following guidelines for good PCB layout:

- 1) Use the correct footprint for the IC and place as many copper planes as possible under the IC footprint to ensure efficient heat transfer.
- 2) Place the ceramic input-bypass capacitors,  $C_{BP}$  and  $C_{IN}$ , as close as possible to the SUP and PGND pins on both sides of the IC. Use low-impedance connections (no vias or other discontinuities) between the capacitors and IC pins.  $C_{BP}$  should be located closest to the IC and should have very good high-frequency performance (small package size and high capacitance). This will provide the best EMI rejection and minimize internal noise on the device, which can degrade performance.
- 3) Place the inductor (L), output capacitors ( $C_{OUT}$ ), bootstrap capacitor ( $C_{BST}$ ) and BIAS capacitor ( $C_{BIAS}$ ) in such a way as to minimize the area enclosed by the current loops. Place the inductor (L) as close as possible to the IC LX pin and minimize the area of the LX node. Place the output capacitors ( $C_{OUT}$ ) near the inductor so that the ground side of  $C_{OUT}$  is near the  $C_{IN}$  ground connection to minimize the current-loop area. Place the BIAS capacitor ( $C_{BIAS}$ ) next to the BIAS pin.
- 4) Place the bootstrap capacitor  $C_{BST}$  close to the IC and use short wide traces to minimize the loop area in order to minimize the parasitic inductance. Use the nearest layer for return trace ( $C_{BST}$  to LX) to minimize the inductance further. Refer to the layout in the EV kit for optimum design. High parasitic inductance can impact switching speed (increase switching losses) and cause high dv/dt noise.
- 5) Use a continuous copper GND plane on the layer next to the IC to shield the entire circuit. GND should also be poured around the entire circuit on the top side. Ensure that all heat-dissipating components have adequate connections to copper for cooling. Use multiple vias to interconnect GND planes/areas for low impedance and maximum heat dissipation. Place vias at the GND terminals of the IC and input/output bypass capacitors. Do not separate or isolate PGND and GND connections with separate planes or areas.
- 6) Place the feedback resistor-divider (if used) near the IC and route the feedback and OUT connections away from the inductor and LX node and other noisy signals.

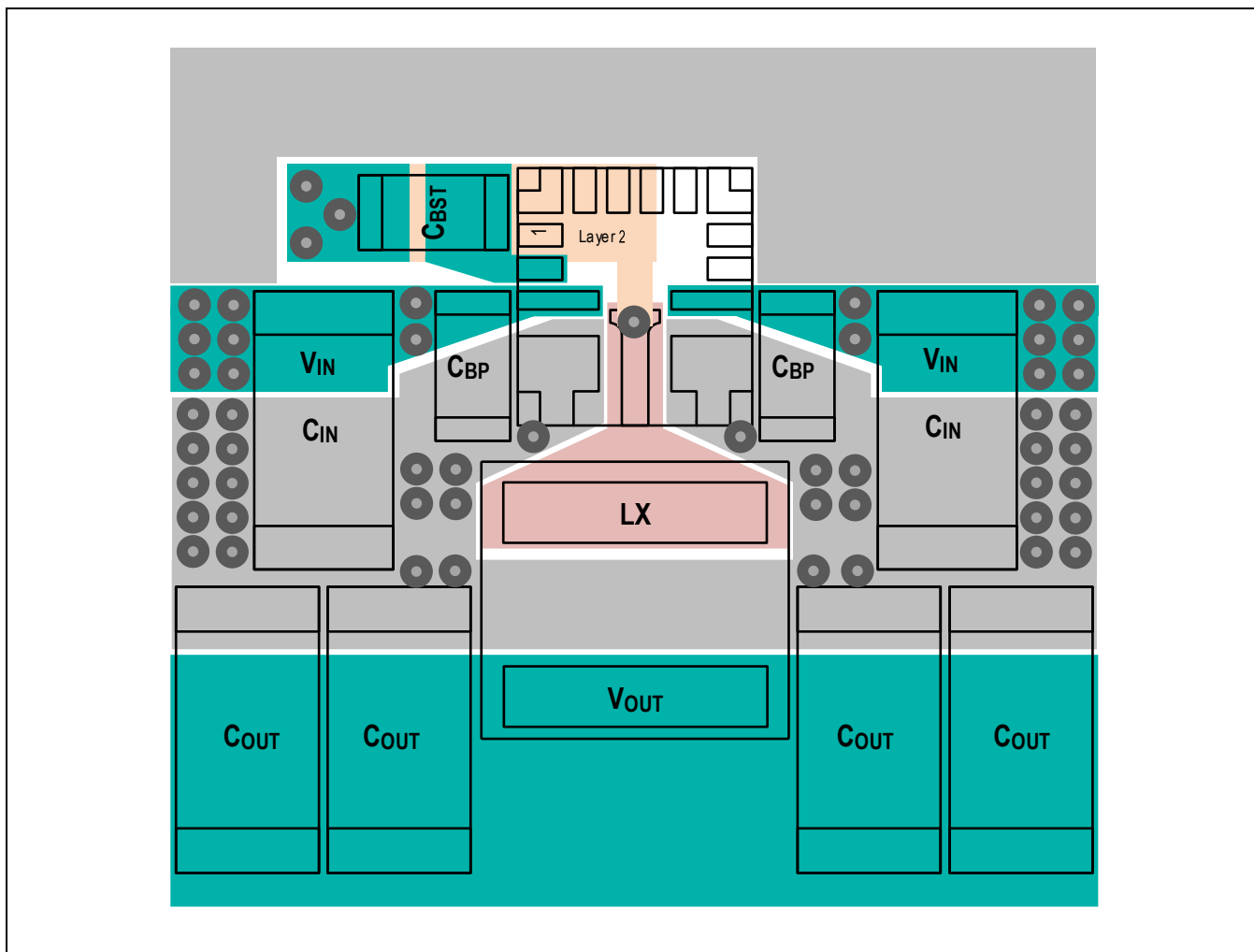
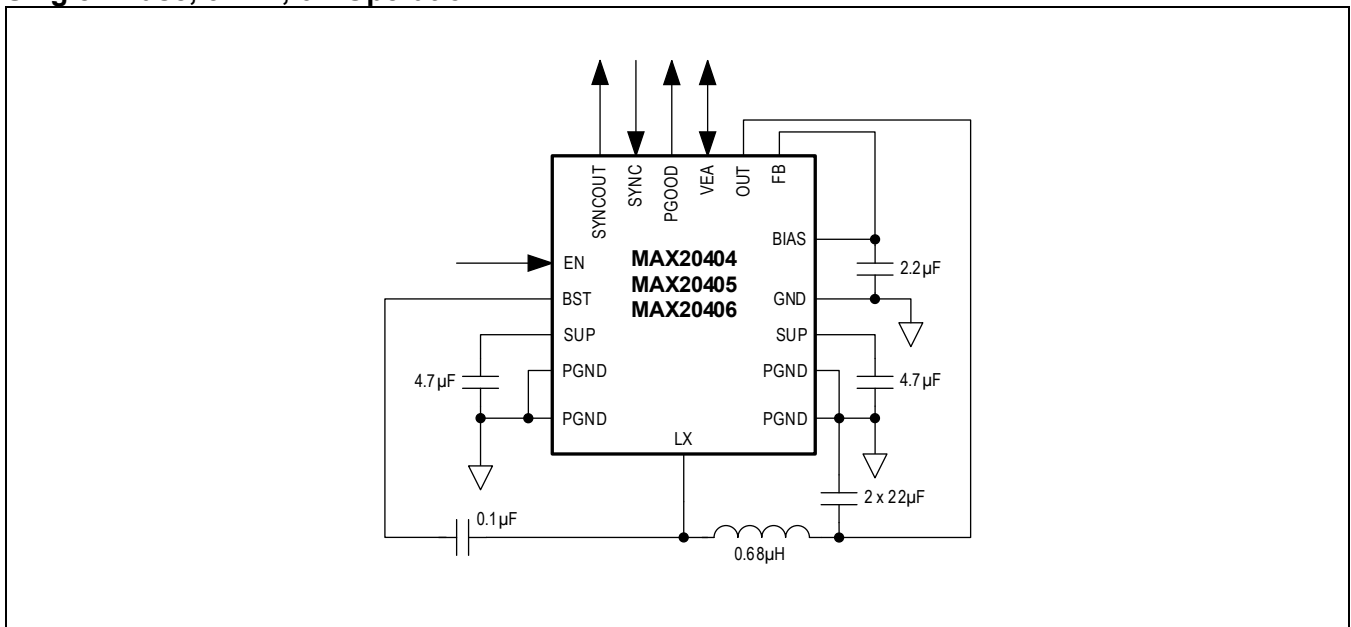

Figure 4. PCB Layout Example



Single-Phase, 3MHz, 6A Operation



Dual-Phase, Controller - Target 2.1MHz and 2.3MHz Operation

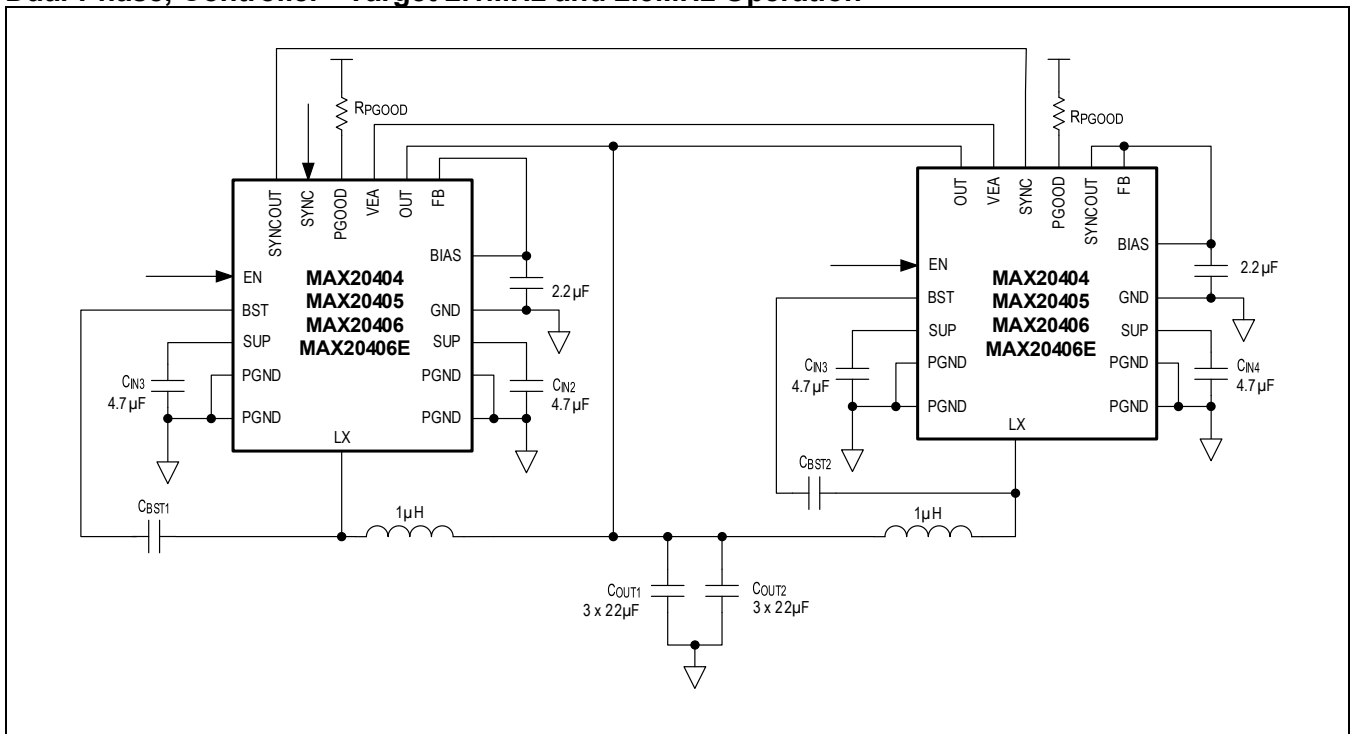

## Ordering Information

PART NUMBER	V <sub>OUT</sub> (FB TIED TO BIAS) <sup>1</sup>	MAXIMUM LOAD CURRENT (A)	FREQUENCY (kHz)	SPREAD SPECTRUM <sup>2</sup>	PACKAGE CODE	C <sub>OUT</sub> OPTION
<b>MAX20404</b> AFOA/VY+	5	4	2100	ON	F173A3FY+6	Standard
MAX20404AFOB/VY+	3.3	4	2100	ON	F173A3FY+6	Standard
MAX20404AFOC/VY+	5	4	400	ON	F173A3FY+6	Standard
MAX20404AFOD/VY+	3.3	4	400	ON	F173A3FY+6	Standard
MAX20404AFOE/VY+	5	4	3000	ON	F173A3FY+6	Standard
MAX20404AFOF/VY+	3.3	4	3000	ON	F173A3FY+6	Standard
MAX20404AFOJ/VY+	4.2	4	400	ON	F173A3FY+6	Standard
MAX20404AFOK/VY+	4.2	4	2100	ON	F173A3FY+6	Standard
<b>MAX20405</b> AFOA/VY+	5	5	2100	ON	F173A3FY+6	Standard
MAX20405AFOB/VY+	3.3	5	2100	ON	F173A3FY+6	Standard
MAX20405AFOC/VY+	5	5	400	ON	F173A3FY+6	Standard
MAX20405AFOD/VY+	3.3	5	400	ON	F173A3FY+6	Standard
MAX20405AFOE/VY+*	5	5	3000	ON	F173A3FY+6	Standard
MAX20405AFOF/VY+	3.3	5	3000	ON	F173A3FY+6	Standard
<b>MAX20406</b> AFOA/VY+	5	6	2100	ON	F173A3FY+6	Standard
MAX20406AFOB/VY+	3.3	6	2100	ON	F173A3FY+6	Standard
MAX20406AFOC/VY+	5	6	400	ON	F173A3FY+6	Standard
MAX20406AFOD/VY+	3.3	6	400	ON	F173A3FY+6	Standard
MAX20406AFOE/VY+	5	6	3000	ON	F173A3FY+6	Standard
MAX20406AFOF/VY+*	3.3	6	3000	ON	F173A3FY+6	Standard
MAX20406AFOG/VY+*	5	6	2100	OFF	F173A3FY+6	Standard
MAX20406AFOH/VY+*	3.3	6	2100	OFF	F173A3FY+6	Standard
MAX20406AFOI/VY+*	3.3	6	2300	ON	F173A3FY+6	Standard
<b>MAX20406E</b> AFLA/VY+	5	6	2100	ON	F153A3FY+2	Standard
MAX20406EAFLB/VY+	3.9	6	2100	ON	F153A3FY+2	Low
MAX20406EAFLC/VY+*	4	6	2100	ON	F153A3FY+2	Standard
MAX20406EAFLD/VY+*	3.3	6	2100	ON	F153A3FY+2	Standard

\* Future part—contact factory for availability.

+ Denotes a lead(Pb)-free/RoHS-compliant package.

T Denotes tape-and-reel.

/VY+ Denotes a side-wettable, automotive-qualified package.

1 Other fixed output voltages between 2.9V to 6V with 100mV step are available, contact the factory for custom requests.

2 All ICs come with spread spectrum turned ON as the default. For SS OFF parts, contact the factory.

**Revision History**

REVISION NUMBER	REVISION DATE	DESCRIPTION	PAGES CHANGED
0	2/21	Initial release	—
1	6/21	Updated General Description, added 3MHz spec in Electrical Characteristics table, removed future products reference for MAX20404AFOE/VY+ in Ordering Information	5, 24
2	8/21	Updated Ordering Information	24
3	9/21	Updated Recommended Components table in Applications Information	15, 16
4	9/21	Updated Ordering Information	24
5	11/21	Updated Ordering Information	24
6	5/22	Updated DS to include MAX20406E, changed wording in General description, changed wording on Benefits and Features, updated all Diagrams to include/not include MAX20406E, added package information for MAX20406E, changed Output Voltage Accuracy section in ECT, updated TOC 18 to include MAX20406E, updated Pin Configurations and Pin Description for SYNCOUT/NC, added Spread Spectrum section, updated Table 1, Table 3, and Table 4, added variants to Ordering Information Table	All
7	6/22	Removed MAX20406E from heading on all pages	All
8	7/22	Added the 2.3MHz variant - updated General Description, Benefits and Features, Electrical Characteristics table, Table 1, Table 3, Table 4, Typical Application Circuits; updated Package Information, Output Capacitor section, and Ordering Information table	1, 3, 5, 14, 17, 19, 21, 23, 24, 25
9	5/23	Added Silent Switcher to datasheet title, added Silent Switcher to General Description, Added Silent Switcher bullet points under Benefits and Features, added TOC34, TOC35, TOC36. Added Low C <sub>OUT</sub> option to Table 1 and to Table 4. Updated Ordering Information table to include Standard and Low C <sub>OUT</sub> options.	1, 10, 17, 21, 25
10	8/23	Updated Silent Switcher bullet point under Benefits and Features, Updated Package Information Table thermal resistance numbers, removed asterisk on future part number MAX20404AFOF/VY+*	1, 3, 25
11	4/24	Updated Simplified Block Diagram and Output Capacitor Selection	2, 21



## Looking for pricing, stock, or lifecycle information?

Click below to explore more details on WIN SOURCE:

- ⊖ [View MAX20404AF0B/VY+ on WIN SOURCE](#)
- ⊖ [Maxim Integrated Information](#)

## Optimize Your Supply Chain with WIN SOURCE Solutions

- ✓ Global Sourcing Solution
- ✓ Obsolete Management
- ✓ Cost Control Management
- ✓ Shortage Management
- ✓ Alternative Solution
- ✓ Excess Inventory Management