



**THE DATASHEET OF  
101KD25**



# DATA SHEET

## METAL OXIDE VARISTORS POWER SUPPLY

25D series

RoHS compliant & Halogen free



Product specification— September 04, 2023 V.3



<b>INDEX</b>	<b>Page</b>
■ <b>Features</b>	<b>3</b>
■ <b>Recommended Applications</b>	<b>3</b>
■ <b>Parameters</b>	<b>3</b>
■ <b>Dimensions</b>	<b>4</b>
■ <b>Electrical Characteristics</b>	<b>5</b>
■ <b>Maximum Surge Current Derating Curve</b>	<b>6</b>
■ <b>Max. Leakage Current and Max. Clamping Voltage Curves</b>	<b>7</b>
■ <b>Reliability</b>	<b>8</b>
■ <b>Soldering Recommendation</b>	<b>9</b>
■ <b>Marking Code</b>	<b>9</b>
■ <b>Quantity</b>	<b>10</b>
■ <b>Storage Condition of Products</b>	<b>10</b>
■ <b>Legal Disclaimer</b>	<b>11</b>

## Metal Oxide Varistor (MOV) Data Sheet

### Features

- Wide operating voltage ( $V_{1mA}$ ) range from 18V to 1800V
- Fast responding to transient over-voltage
- Large absorbing transient energy capability
- Low clamping ratio and no follow-on current
- Meets MSL level 1, per J-STD-020
- Operating Temperature:  $-40^{\circ}\text{C} \sim +105^{\circ}\text{C}$
- Storage Temperature:  $-40^{\circ}\text{C} \sim +125^{\circ}\text{C}$
- Safety certification: UL、CSA、VDE



### Applications

- Transistor, diode, IC, thyristor or triac semiconductor protection
- Surge protection in consumer electronics
- Surge protection in industrial electronics
- Surge protection in electronic home appliances, gas and petroleum appliances
- Relay and electromagnetic valve surge absorption

### Part Number Code

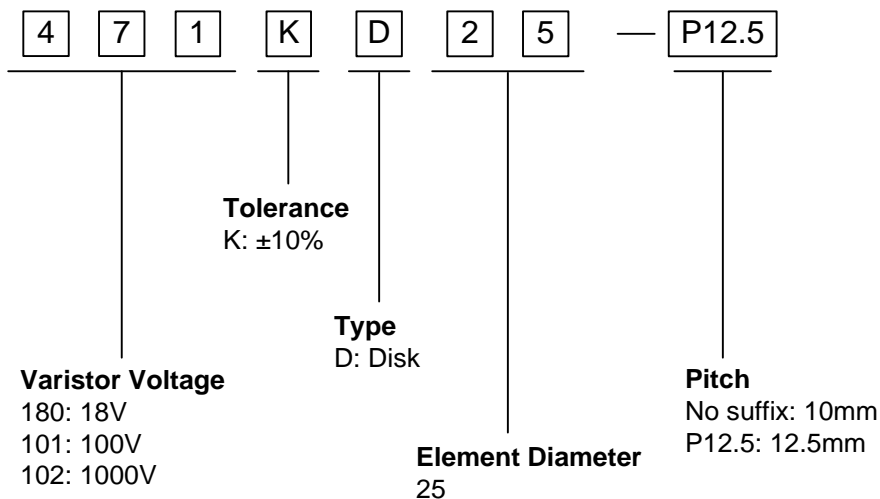

Dimensions

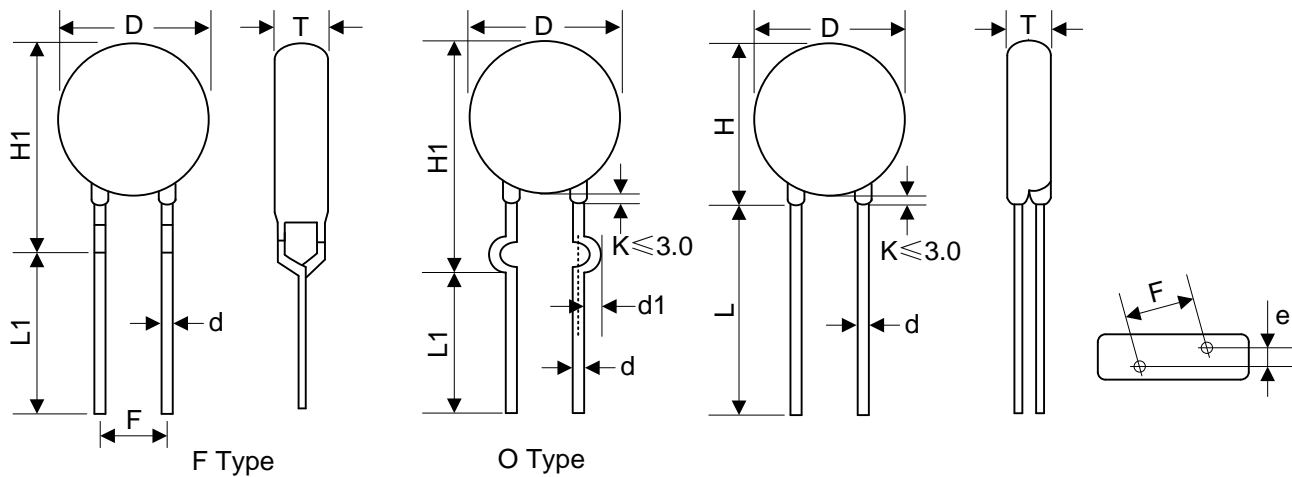

Notes: Varistor voltage ≥ 1200V, structure diagram is F type.

Table 1	
Unit: mm	
Symbol	Dimension
H	27.0~31.5
H1	28.0~34.0
L(min.)	20.0
L1(min.)	15.0
D	25.0~28.0
F(±1.0)	10.0/12.5
T	Table 2
e(±0.8)	Table 2
d(±0.1)	1.0
d1(±0.4)	1.4/1.6

Table 2					
Unit: mm					
Model	T	e	Model	T	e
180K	2.5~4.8	1.7	361K	3.4~5.9	2.9
220K	2.6~4.9	1.8	391K	3.5~6.1	3.0
270K	2.6~5.0	2.0	431K	3.7~6.4	3.2
330K	2.7~5.2	1.9	471K	3.8~6.7	3.4
390K	2.6~5.5	2.0	511K	3.9~7.0	3.6
470K	2.7~5.1	2.1	561K	4.1~7.3	3.8
560K	2.8~5.4	2.3	621K	4.3~7.6	4.1
680K	2.9~5.7	2.6	681K	4.5~7.8	4.4
820K	2.6~4.5	2.0	751K	4.8~8.0	4.5
101K	2.9~4.6	2.2	781K	4.9~8.1	4.6
121K	2.9~4.8	2.4	821K	5.1~8.4	4.8
151K	2.7~4.9	2.0	911K	5.3~8.9	5.2
181K	2.8~5.2	2.1	102K	5.9~9.5	5.2
201K	2.9~5.2	2.2	112K	6.3~10.1	5.6
221K	3.0~5.3	2.3	122K	6.4~10.7	6.0
241K	3.1~5.8	2.4	142K	7.4~12.6	6.8
271K	3.1~5.3	2.6	162K	7.9~13.2	7.6
301K	3.2~5.5	2.7	182K	8.1~14.5	8.4
331K	3.2~5.7	2.7			

## Electrical Characteristics

Part Number	Maximum Allowable Voltage		Varistor Voltage	Maximum Clamping Voltage		Withstanding Surge Current	Maximum Energy (10/1000 $\mu$ s)	Rated Power	Typical Capacitance (Reference)
	V <sub>AC</sub> (V)	V <sub>DC</sub> (V)	V <sub>1mA</sub> (V)	I <sub>P</sub> (A)	V <sub>C</sub> (V)	I (A)	(J)	(W)	@1KHz (pf)
180KD25	11	14	18(15~21.6)	30	36	4500	20	0.25	45000
220KD25	14	18	22(19.5~26)	30	43	4500	25	0.25	29000
270KD25	17	22	27(24~31)	30	53	4500	30	0.25	26500
330KD25	20	26	33(29.5~36.5)	30	65	4500	35	0.25	18000
390KD25	25	31	39(35~43)	30	77	4500	40	0.25	13500
470KD25	30	38	47(42~52)	30	93	4500	50	0.25	11500
560KD25	35	45	56(50~62)	30	110	4500	60	0.25	10500
680KD25	40	56	68(61~75)	30	135	4500	70	0.25	9050
820KD25	50	65	82(74~90)	150	135	15000	80	1.2	7700
101KD25	60	85	100(90~110)	150	165	15000	100	1.2	6300
121KD25	75	100	120(108~132)	150	200	15000	120	1.2	5200
151KD25	95	125	150(135~165)	150	250	15000	160	1.2	4300
181KD25	115	150	180(162~198)	150	300	15000	175	1.2	3500
201KD25	130	170	200(180~220)	150	340	15000	190	1.2	3200
221KD25	140	180	220(198~242)	150	360	15000	200	1.2	2900
241KD25	150	200	240(216~264)	150	395	15000	220	1.2	2650
271KD25	175	225	270(243~297)	150	455	15000	255	1.2	2400
301KD25	190	250	300(270~330)	150	500	15000	275	1.2	2100
331KD25	210	275	330(297~363)	150	550	15000	300	1.2	1900
361KD25	230	300	360(324~396)	150	595	15000	330	1.2	1750
391KD25	250	320	390(351~429)	150	650	15000	360	1.2	1600
431KD25	275	350	430(387~473)	150	710	15000	380	1.2	1500
471KD25	300	385	470(423~517)	150	775	15000	400	1.2	1400
511KD25	320	415	510(459~561)	150	845	15000	420	1.2	1250
561KD25	350	460	560(504~616)	150	925	15000	440	1.2	1150
621KD25	385	505	620(558~682)	150	1025	15000	450	1.2	1050
681KD25	420	560	680(612~748)	150	1120	15000	460	1.2	950
751KD25	460	615	750(675~825)	150	1240	15000	510	1.2	850
781KD25	485	640	780(702~858)	150	1290	15000	530	1.2	850
821KD25	510	670	820(738~902)	150	1355	15000	570	1.2	800
911KD25	550	745	910(819~1001)	150	1500	15000	620	1.2	700
102KD25	625	825	1000(900~1100)	150	1650	15000	685	1.2	650
112KD25	680	895	1100(990~1210)	150	1815	15000	720	1.2	600
122KD25	750	990	1200(1080~1320)	150	1980	15000	792	1.2	550
142KD25	880	1140	1400(1260~1540)	150	2310	15000	850	1.2	500
162KD25	1000	1280	1600(1440~1760)	150	2640	15000	970	1.2	450
182KD25	1100	1465	1800(1620~1980)	150	2970	15000	1092	1.2	400

Notes: 1. The tolerance of varistor voltage between 18V and 27V is more than 10%.

2. Leakage Current (@83% of V<sub>1mA</sub>) : IR $\leq$ 50 $\mu$ A (180K~680K) ; IR $\leq$ 40 $\mu$ A (820K~182K)

**Maximum Surge Current Derating Curve**

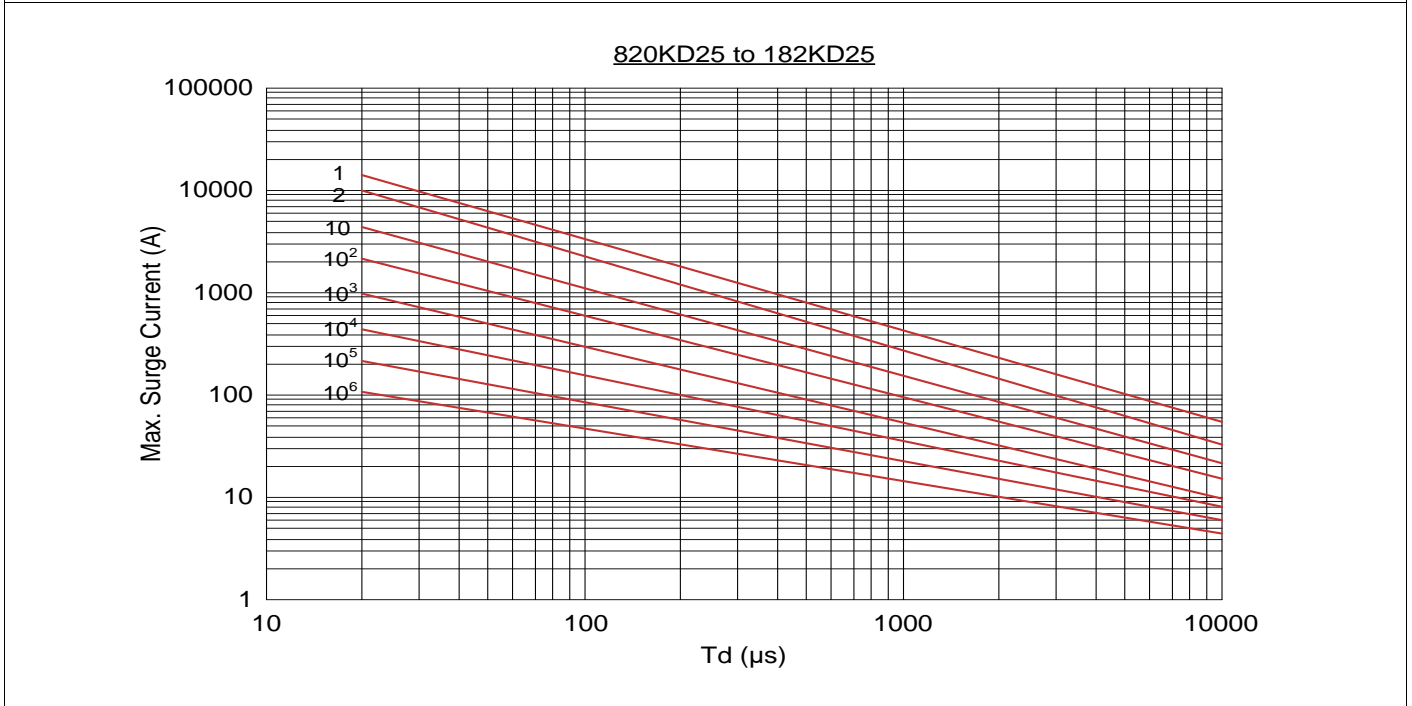
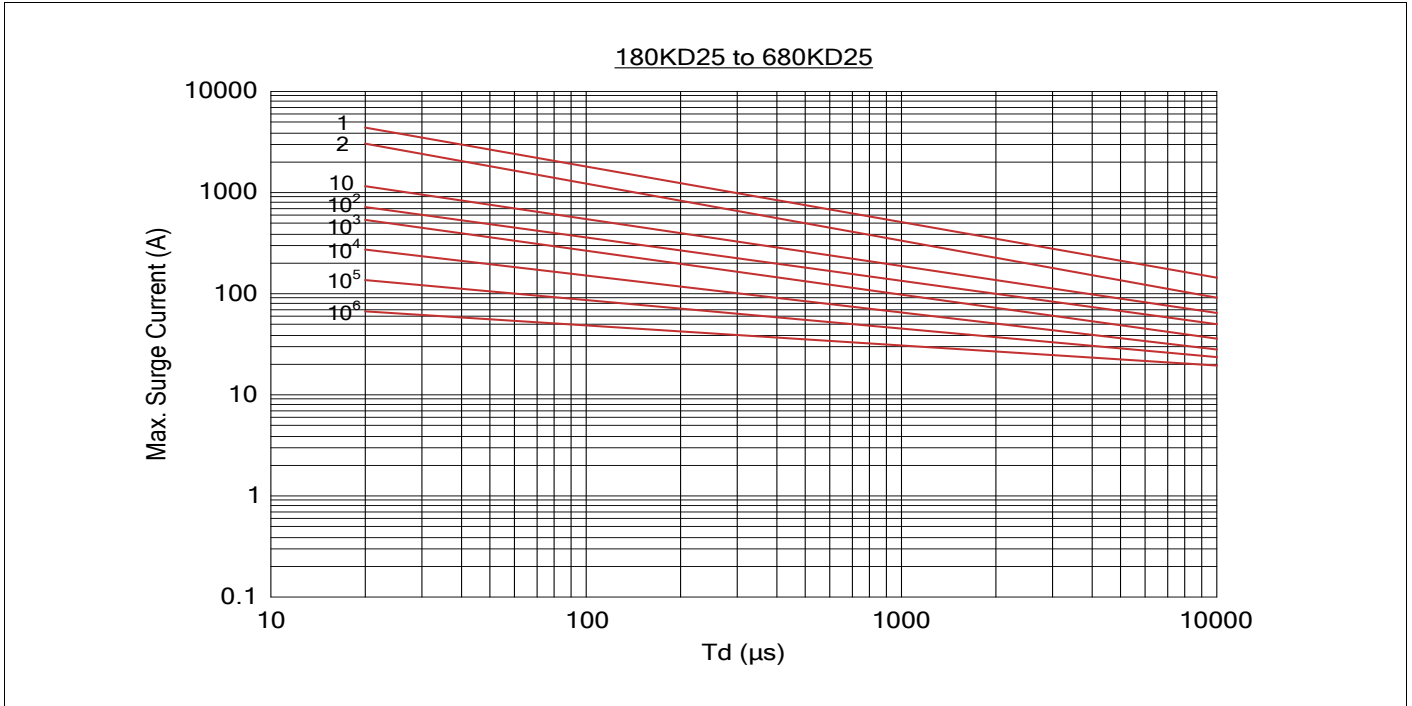

Maximum Leakage Current and Maximum Clamping Voltage Curve

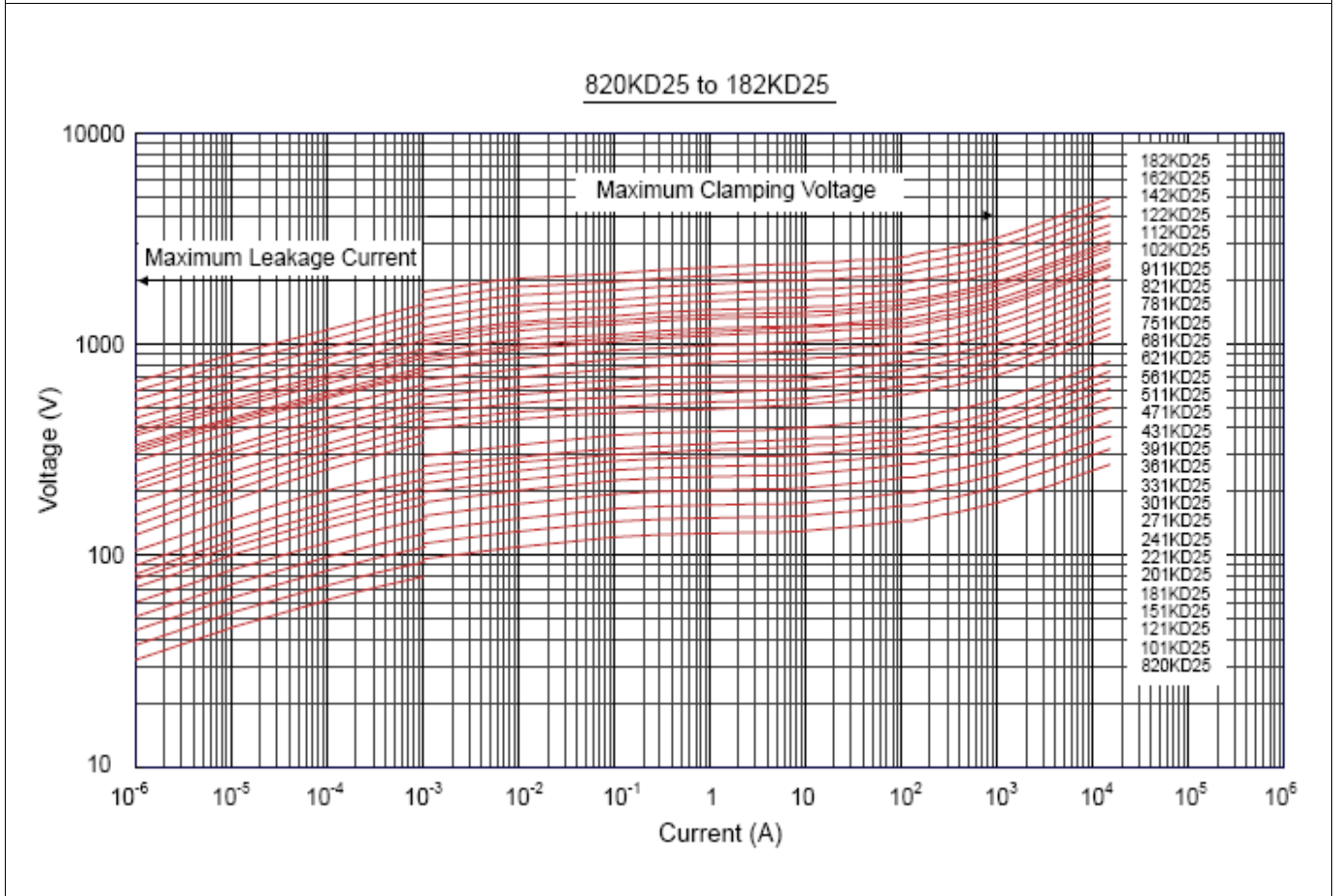
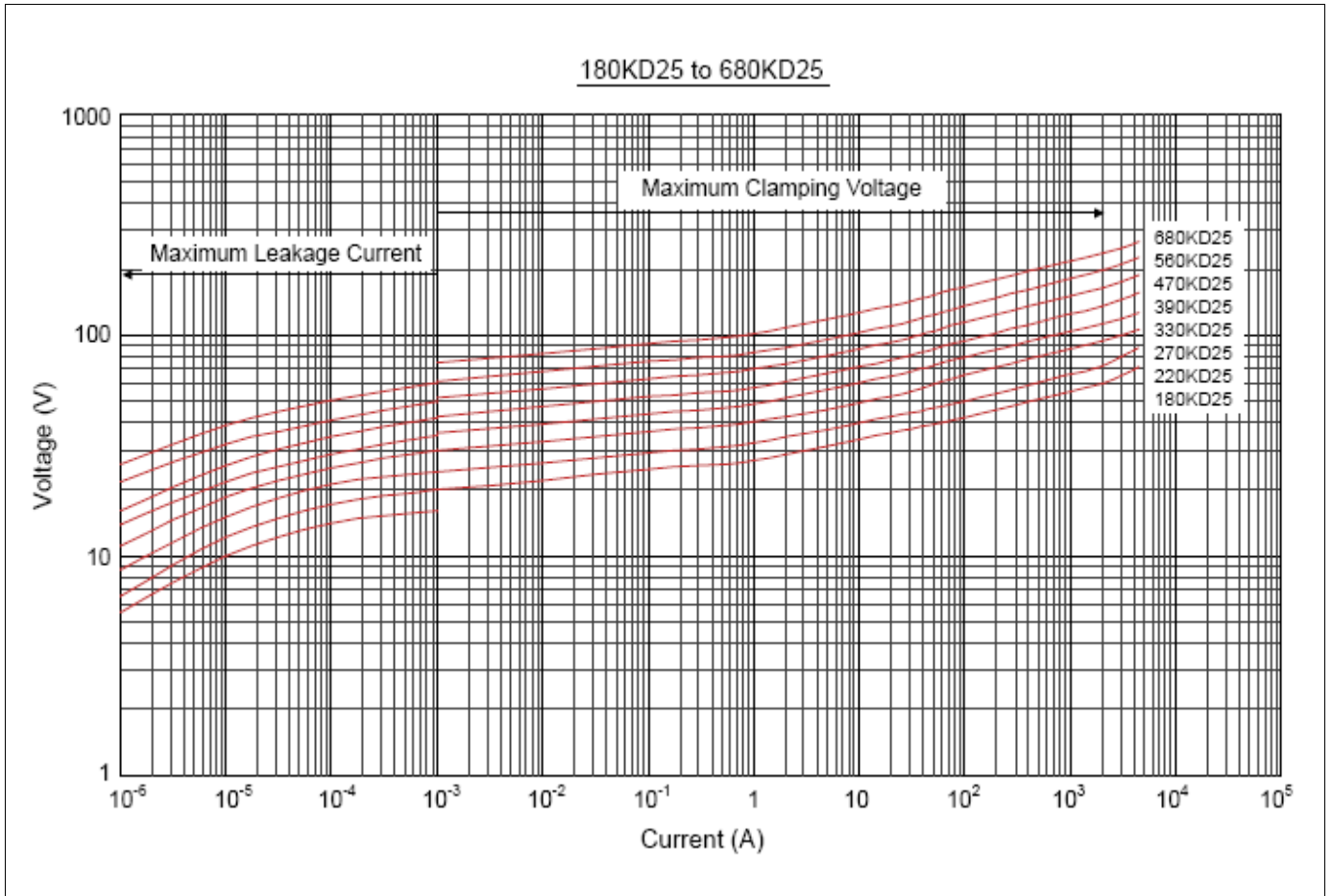

**Reliability**

Items	Standard	Test conditions / Methods	Specifications															
Tensile Strength of Terminals	IEC60068-2-21	Gradually applying the force specified and keeping the unit fixed for 10±1 sec.  <table style="width: 100%; border-collapse: collapse;"> <tr> <td style="text-align: center; border-bottom: 1px solid black;">Terminal diameter (mm)</td> <td style="text-align: center; border-bottom: 1px solid black;">Force (kg)</td> </tr> <tr> <td style="text-align: center;">0.5&lt;d≤0.8</td> <td style="text-align: center;">1.0</td> </tr> <tr> <td style="text-align: center;">0.8&lt;d≤1.25</td> <td style="text-align: center;">2.0</td> </tr> <tr> <td style="text-align: center;">1.25&lt;d</td> <td style="text-align: center;">4.0</td> </tr> </table>	Terminal diameter (mm)	Force (kg)	0.5<d≤0.8	1.0	0.8<d≤1.25	2.0	1.25<d	4.0	No visible damage  ΔV <sub>1mA</sub> /V <sub>1mA</sub>   ≤5%							
Terminal diameter (mm)	Force (kg)																	
0.5<d≤0.8	1.0																	
0.8<d≤1.25	2.0																	
1.25<d	4.0																	
Bending Strength of Terminals	IEC60068-2-21	Hold specimen and apply the force specified below to each lead. Bend the specimen to 90°, then return to the original position. Repeat the procedure in the opposite direction.  <table style="width: 100%; border-collapse: collapse;"> <tr> <td style="text-align: center; border-bottom: 1px solid black;">Terminal diameter (mm)</td> <td style="text-align: center; border-bottom: 1px solid black;">Force (kg)</td> </tr> <tr> <td style="text-align: center;">0.5&lt;d≤0.8</td> <td style="text-align: center;">0.5</td> </tr> <tr> <td style="text-align: center;">0.8&lt;d≤1.25</td> <td style="text-align: center;">1.0</td> </tr> <tr> <td style="text-align: center;">1.25&lt;d</td> <td style="text-align: center;">2.0</td> </tr> </table>	Terminal diameter (mm)	Force (kg)	0.5<d≤0.8	0.5	0.8<d≤1.25	1.0	1.25<d	2.0	No visible damage  ΔV <sub>1mA</sub> /V <sub>1mA</sub>   ≤5%							
Terminal diameter (mm)	Force (kg)																	
0.5<d≤0.8	0.5																	
0.8<d≤1.25	1.0																	
1.25<d	2.0																	
Vibration	IEC60068-2-6	Frequency range: 10~55 Hz Amplitude: 0.75mm or 98m/s <sup>2</sup> Direction: 3 mutually perpendicular directions, 2hrs each.	No visible damage  ΔV <sub>1mA</sub> /V <sub>1mA</sub>   ≤5%															
Solderability	IEC60068-2-20	Solder Temp: 245±5°C Dipping Time: 2±0.5 sec	At least 95% of terminal electrode is covered by new solder															
Resistance to Soldering Heat	IEC60068-2-20	Solder Temp: 260±5°C Dipping Time: 10±1 sec	No visible damage  ΔV <sub>1mA</sub> /V <sub>1mA</sub>   ≤5%															
High Temperature Storage	IEC60068-2-2	Ambient Temp: 125±2°C Duration: 1000±24hrs	No visible damage  ΔV <sub>1mA</sub> /V <sub>1mA</sub>   ≤5%															
Low Temperature Storage	IEC60068-2-1	Ambient Temp: -40±2°C Duration: 1000±24hrs	No visible damage  ΔV <sub>1mA</sub> /V <sub>1mA</sub>   ≤5%															
Damp Heat, Steady State	IEC60068-2-78	The test is divided into two groups . a. 40±2°C , 90~95% RH for 1344±24hrs b. 40±2°C , 90~95% RH, at 10%VDC , 1344±24 hrs	No visible damage  ΔV <sub>1mA</sub> /V <sub>1mA</sub>   ≤10% Insulation Resistance ≥ 100MΩ															
High Temperature Load	MIL-STD-202 Method 108	Ambient Temp: 105±2°C    Duration: 1000±24hrs Load: Max. Allowable Voltage In AC.	ΔV <sub>1mA</sub> /V <sub>1mA</sub>   ≤10%															
Temperature Cycle	IEC60068-2-14	The conditions shown below shall be repeated 5 cycles <table border="1" style="width: 100%; border-collapse: collapse; margin-top: 5px;"> <thead> <tr> <th>Step</th> <th>Temperature (°C)</th> <th>Period (minutes)</th> </tr> </thead> <tbody> <tr> <td style="text-align: center;">1</td> <td style="text-align: center;">-40±3</td> <td style="text-align: center;">30±3</td> </tr> <tr> <td style="text-align: center;">2</td> <td style="text-align: center;">Room temperature</td> <td style="text-align: center;">5±3</td> </tr> <tr> <td style="text-align: center;">3</td> <td style="text-align: center;">125±3</td> <td style="text-align: center;">30±3</td> </tr> <tr> <td style="text-align: center;">4</td> <td style="text-align: center;">Room temperature</td> <td style="text-align: center;">5±3</td> </tr> </tbody> </table>	Step	Temperature (°C)	Period (minutes)	1	-40±3	30±3	2	Room temperature	5±3	3	125±3	30±3	4	Room temperature	5±3	No visible damage  ΔV <sub>1mA</sub> /V <sub>1mA</sub>   ≤5%
Step	Temperature (°C)	Period (minutes)																
1	-40±3	30±3																
2	Room temperature	5±3																
3	125±3	30±3																
4	Room temperature	5±3																
8/20uS Surge Life	IEC61051-1	8/20μS waveform, 10 surge currents, unipolar, interval 30secs, amplitude corresponding to max. surge current derating curves for 20μS.	No visible damage ΔV <sub>b</sub> (1mA) ≅ ±10%															
10/1000μS Surge Life	IEC61051-1	10/1000μS waveform, 10 surge currents, unipolar, interval 2mins, amplitude corresponding to max. surge current derating curves for 1000μS.	No visible damage  ΔV <sub>1mA</sub> /V <sub>1mA</sub>   ≤10%															
Voltage Proof	IEC61051-1	Metal balls method, 2500Vac 1 min.	No visible damage															

Soldering Recommendation

Lead-free Wave Soldering Recommendation

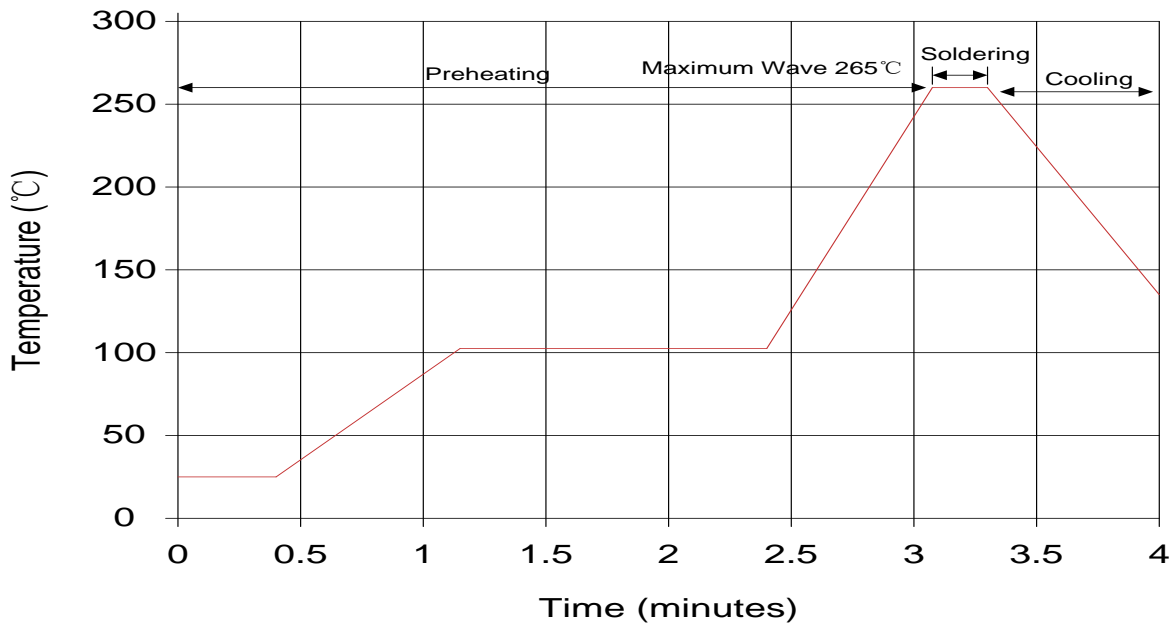

Item	Conditions
Peak Temperature	265°C
Dipping Time	10 seconds (max.)
Soldering	1 time

Recommendation Reworking Conditions with Soldering Iron

Item	Conditions
Temperature of Soldering Iron-tip	360°C (max.)
Soldering Time	3 seconds (max.)
Distance from Varistor	2mm (min.)

Marking Code

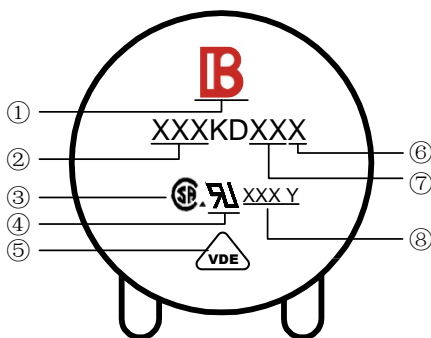

- ① Brightking Logo
- ② Varistor Voltage
- ③ CSA Accreditation Logo
- ④ UL Accreditation Logo
- ⑤ VDE Accreditation Logo
- ⑥ “J” is High Surge Code, no “J” is Standard Surge
- ⑦ Disk Size
- ⑧ Internal control code

**Quantity**

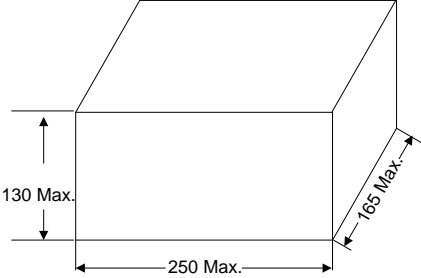
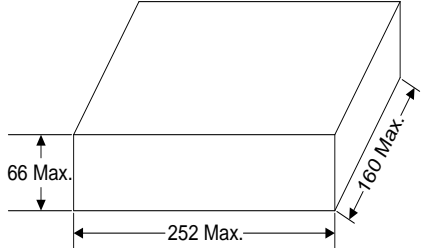
Packaging Dimensions (Unit: mm)	Quantity
<p>In bulk for Terminals Untrimmed Products</p> 	<p>100pcs/bag 4bags/box (180K~621K)</p>
	<p>50pcs/bag 4bags/box (681K~182K)</p>
<p>In bulk for Terminals Trimmed Products</p> 	<p>100pcs/bag 4bags/box (180K~621K)</p>
	<p>50pcs/bag 4bags/box (681K~182K)</p>

**Storage Condition of Products**

(I) Storage Conditions :

- 1.Storage Temperature : -10℃ ~ +40℃
- 2.Relative Humidity : ≅80%RH
- 3.Keep away from corrosive atmosphere and sunlight.

(II) Period of Storage : 1 year

LEGAL DISCLAIMER

YAGEO, its distributors and agents (collectively, "YAGEO"), hereby disclaims any and all liabilities for any errors, inaccuracies or incompleteness contained in any product related information, including but not limited to product specifications, datasheets, pictures and/or graphics. YAGEO may make changes, modifications and/or improvements to product related information at any time and without notice.



YAGEO makes no representation, warranty, and/or guarantee about the fitness of its products for any particular purpose or the continuing production of any of its products. To the maximum extent permitted by law, YAGEO disclaims (i) any and all liability arising out of the application or use of any YAGEO product, (ii) any and all liability, including without limitation special, consequential or incidental damages, and (iii) any and all implied warranties, including warranties of fitness for a particular purpose, non-infringement and merchantability.

YAGEO products are designed for general purpose applications under normal operation and usage conditions. Please contact YAGEO for the applications listed below which require especially high reliability for the prevention of defects which might directly cause damage to the third party's life, body or property: Aerospace equipment (artificial satellite, rocket, etc.), Atomic energy-related equipment, Aviation equipment, Disaster prevention equipment, crime prevention equipment, Electric heating apparatus, burning equipment, Highly public information network equipment, data-processing equipment, Medical devices, Military equipment, Power generation control equipment, Safety equipment, Traffic signal equipment, Transportation equipment and Undersea equipment, or for any other application or use in which the failure of YAGEO products could result in personal injury or death, or serious property damage. Particularly **YAGEO Corporation and its affiliates do not recommend the use of commercial or automotive grade products for high reliability applications or manned space flight.**





Information provided here is intended to indicate product specifications only. YAGEO reserves all the rights for revising this content without further notification, as long as products are unchanged. Any product change will be announced by PCN.

## Looking for pricing, stock, or lifecycle information?

Click below to explore more details on WIN SOURCE:

-  [View 101KD25 on WIN SOURCE](#)
-  [Yageo Information](#)

## Optimize Your Supply Chain with WIN SOURCE Solutions

-  Global Sourcing Solution
-  Obsolete Management
-  Cost Control Management
-  Shortage Management
-  Alternative Solution
-  Excess Inventory Management