

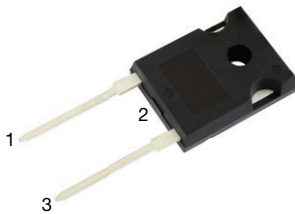

**THE DATASHEET OF  
VS-EPH3007L-N3**



## Hyperfast Rectifier, 30 A FRED Pt<sup>®</sup>



TO-247AD 2L

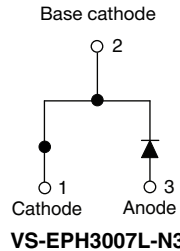

VS-EPH3007L-N3

### FEATURES

- Low forward voltage drop
- Hyperfast soft recovery time
- 175 °C operating junction temperature
- Material categorization:  
for definitions of compliance please see [www.vishay.com/doc?99912](http://www.vishay.com/doc?99912)

**RoHS**  
COMPLIANT  
HALOGEN  
**FREE**

### DESCRIPTION / APPLICATIONS

Hyperfast recovery rectifiers designed with optimized performance of forward voltage drop, hyperfast recovery time, and soft recovery.

The planar structure and the platinum doped life time control guarantee the best overall performance, ruggedness and reliability characteristics.

These devices are intended for use in PFC Boost stage in the AC/DC section of SMPS, inverters or as freewheeling diodes.

The extremely optimized stored charge and low recovery current minimize the switching losses and reduce over dissipation in the switching element and snubbers.

### MECHANICAL DATA

**Case:** TO-247AD 2L

Molding compound meets UL 94 V-0 flammability rating

**Terminals:** matte tin plated leads, solderable per J-STD-002

### LINKS TO ADDITIONAL RESOURCES



PRIMARY CHARACTERISTICS	
$I_{F(AV)}$	30 A
$V_R$	650 V
$V_F$ at $I_F$	1.4 V
$t_{rr}$ typ.	33 ns
$T_J$ max.	175 °C
Package	TO-247AD 2L
Circuit configuration	Single

ABSOLUTE MAXIMUM RATINGS				
PARAMETER	SYMBOL	TEST CONDITIONS	MAX.	UNITS
Repetitive peak reverse voltage	$V_{RRM}$		650	V
Average rectified forward current	$I_{F(AV)}$	$T_C = 113$ °C	30	A
Non-repetitive peak surge current	$I_{FSM}$	$T_C = 25$ °C, $t_p = 8.3$ ms, half sine wave	195	
Operating junction and storage temperatures	$T_J, T_{Stg}$		-55 to +175	°C

ELECTRICAL SPECIFICATIONS ( $T_J = 25$ °C unless otherwise specified)						
PARAMETER	SYMBOL	TEST CONDITIONS	MIN.	TYP.	MAX.	UNITS
Breakdown voltage, blocking voltage	$V_{BR}, V_R$	$I_R = 100$ $\mu$ A	650	-	-	V
Forward voltage	$V_F$	$I_F = 30$ A	-	1.8	2.1	
		$I_F = 30$ A, $T_J = 150$ °C	-	1.4	1.6	
Reverse leakage current	$I_R$	$V_R = V_R$ rated	-	0.02	30	$\mu$ A
		$T_J = 150$ °C, $V_R = V_R$ rated	-	-	300	
Junction capacitance	$C_T$	$V_R = 650$ V	-	22	-	pF
Series inductance	$L_S$	Measured lead to lead 5 mm from package body	-	8.0	-	nH



<b>DYNAMIC RECOVERY CHARACTERISTICS</b> ( $T_J = 25\text{ }^\circ\text{C}$ unless otherwise specified)							
PARAMETER	SYMBOL	TEST CONDITIONS	MIN.	TYP.	MAX.	UNITS	
Reverse recovery time	$t_{rr}$	$I_F = 1\text{ A}$ , $di_F/dt = 100\text{ A}/\mu\text{s}$ , $V_R = 30\text{ V}$	-	37	-	ns	
		$T_J = 25\text{ }^\circ\text{C}$	-	33	-		
		$T_J = 125\text{ }^\circ\text{C}$	-	88	-		
Peak recovery current	$I_{RRM}$	$I_F = 30\text{ A}$ $di_F/dt = 1000\text{ A}/\mu\text{s}$ $V_R = 400\text{ V}$	$T_J = 25\text{ }^\circ\text{C}$	-	18	-	A
			$T_J = 125\text{ }^\circ\text{C}$	-	30	-	
Reverse recovery charge	$Q_{rr}$	$I_F = 30\text{ A}$ $di_F/dt = 1000\text{ A}/\mu\text{s}$ $V_R = 400\text{ V}$	$T_J = 25\text{ }^\circ\text{C}$	-	450	-	nC
			$T_J = 125\text{ }^\circ\text{C}$	-	1350	-	

<b>THERMAL - MECHANICAL SPECIFICATIONS</b>						
PARAMETER	SYMBOL	TEST CONDITIONS	MIN.	TYP.	MAX.	UNITS
Maximum junction and storage temperature range	$T_J, T_{Stg}$		-55	-	175	$^\circ\text{C}$
Thermal resistance, junction to case	$R_{thJC}$		-	0.7	1.1	$^\circ\text{C}/\text{W}$
Thermal resistance, case to heatsink	$R_{thCS}$	Mounting surface, flat, smooth, and greased	-	0.5	-	
Weight			-	5.5	-	g
			-	0.2	-	oz.
Mounting torque			1.2 (10)	-	2.4 (20)	kgf · cm (lbf · in)
Marking device		Case style TO-247 2L	EPH3007L			

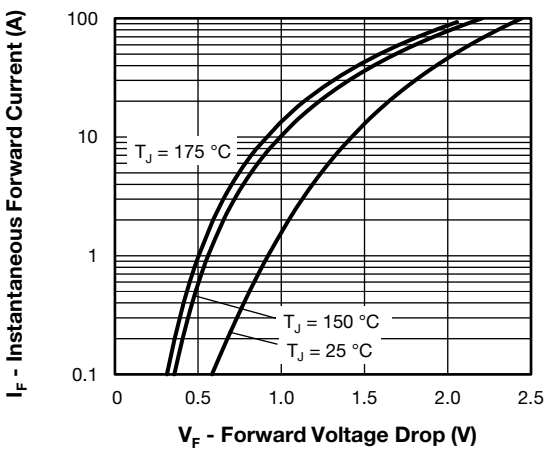

Fig. 1 - Typical Forward Voltage Drop Characteristics

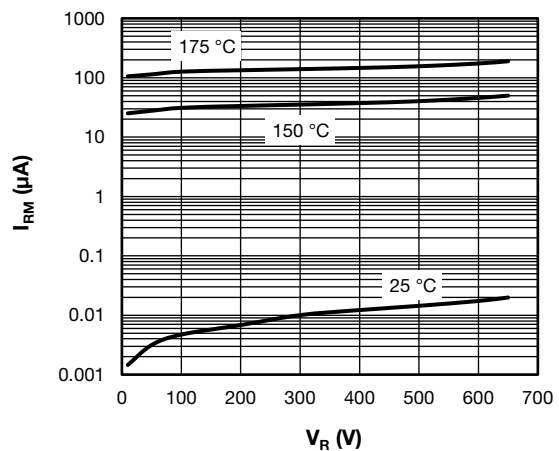

Fig. 2 - Typical Values of Reverse Current vs. Reverse Voltage

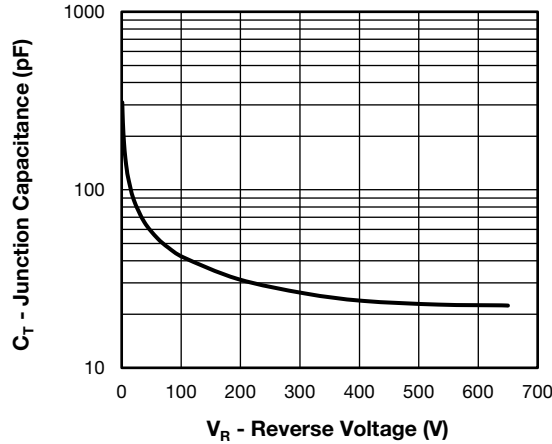

Fig. 3 - Typical Junction Capacitance vs. Reverse Voltage

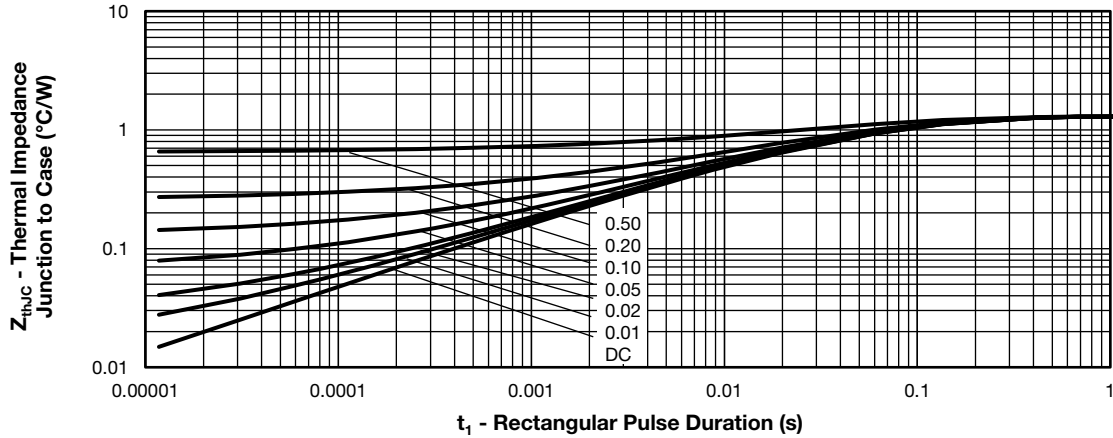

Fig. 4 - Maximum Thermal Impedance  $Z_{thJC}$  Characteristics

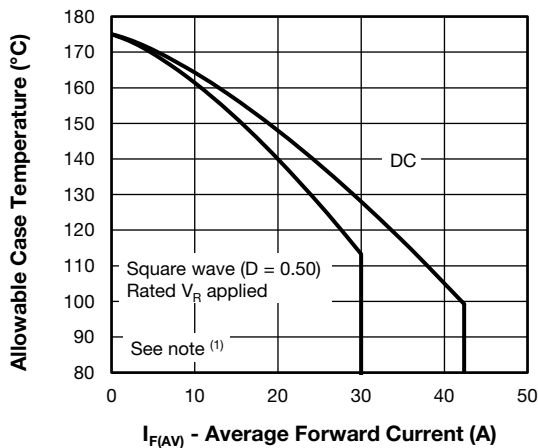

Fig. 5 - Maximum Allowable Case Temperature vs. Average Forward Current

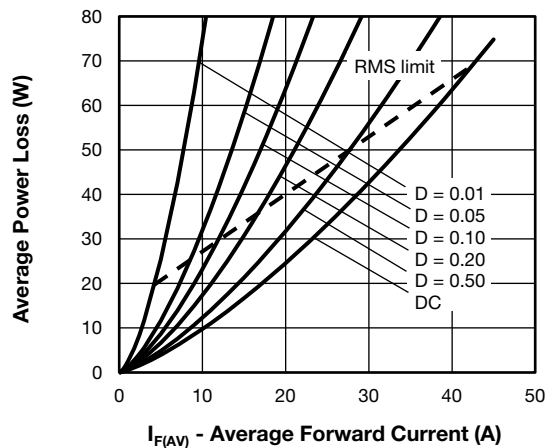

Fig. 6 - Forward Power Loss Characteristics

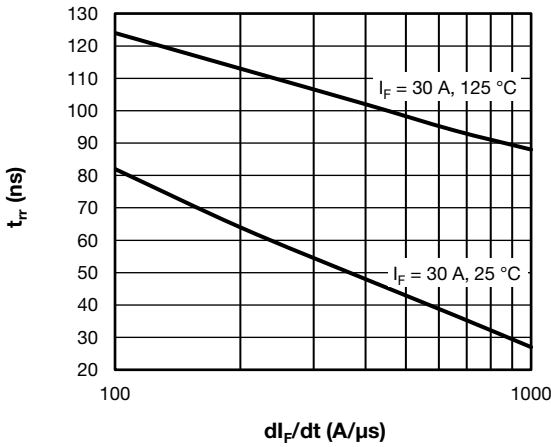

Fig. 7 - Typical Reverse Recovery Time vs.  $di_F/dt$

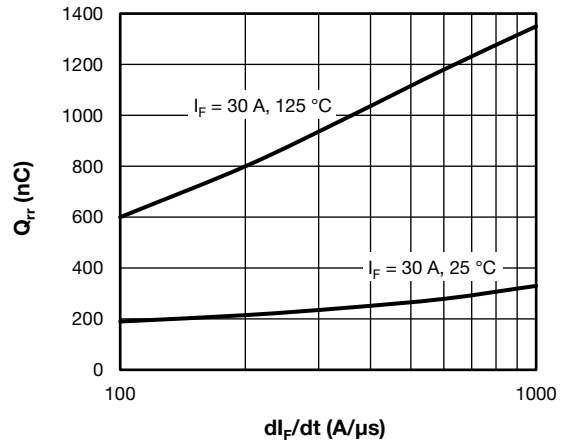

Fig. 8 - Typical Stored Charge vs.  $di_F/dt$

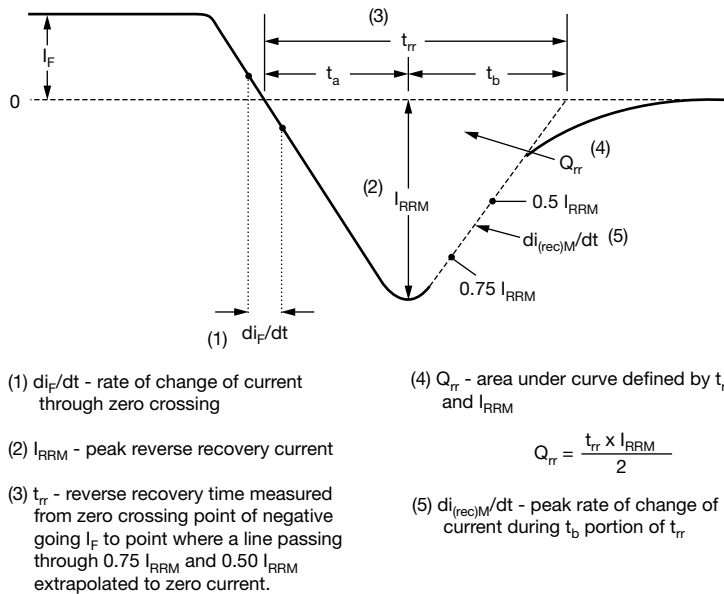
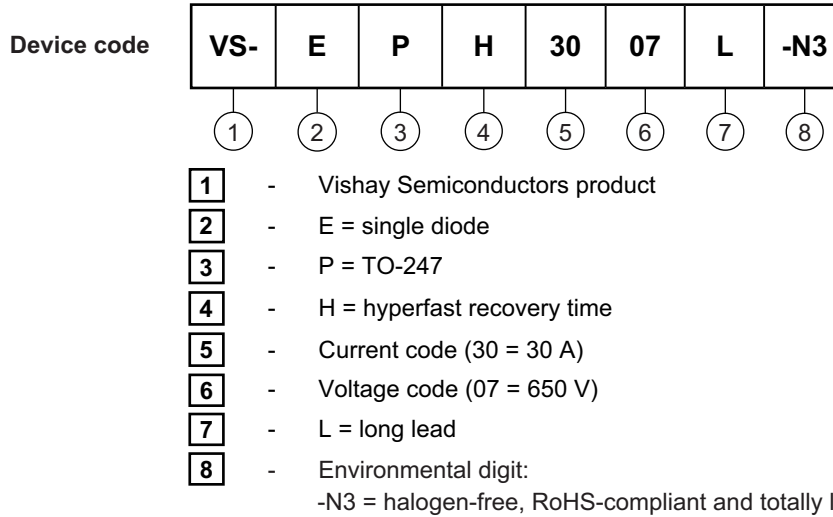

Fig. 9 - Reverse Recovery Waveform and Definitions



**ORDERING INFORMATION TABLE**



<b>ORDERING INFORMATION</b> (Example)			
PREFERRED P/N	QUANTITY PER TUBE	MINIMUM ORDER QUANTITY	PACKAGING DESCRIPTION
VS-EPH3007L-N3	25	500	Antistatic plastic tube

<b>LINKS TO RELATED DOCUMENTS</b>	
Dimensions	<a href="http://www.vishay.com/doc?95536">www.vishay.com/doc?95536</a>
Part marking information	<a href="http://www.vishay.com/doc?95648">www.vishay.com/doc?95648</a>



TO-247AD 2L

**DIMENSIONS** in millimeters and inches

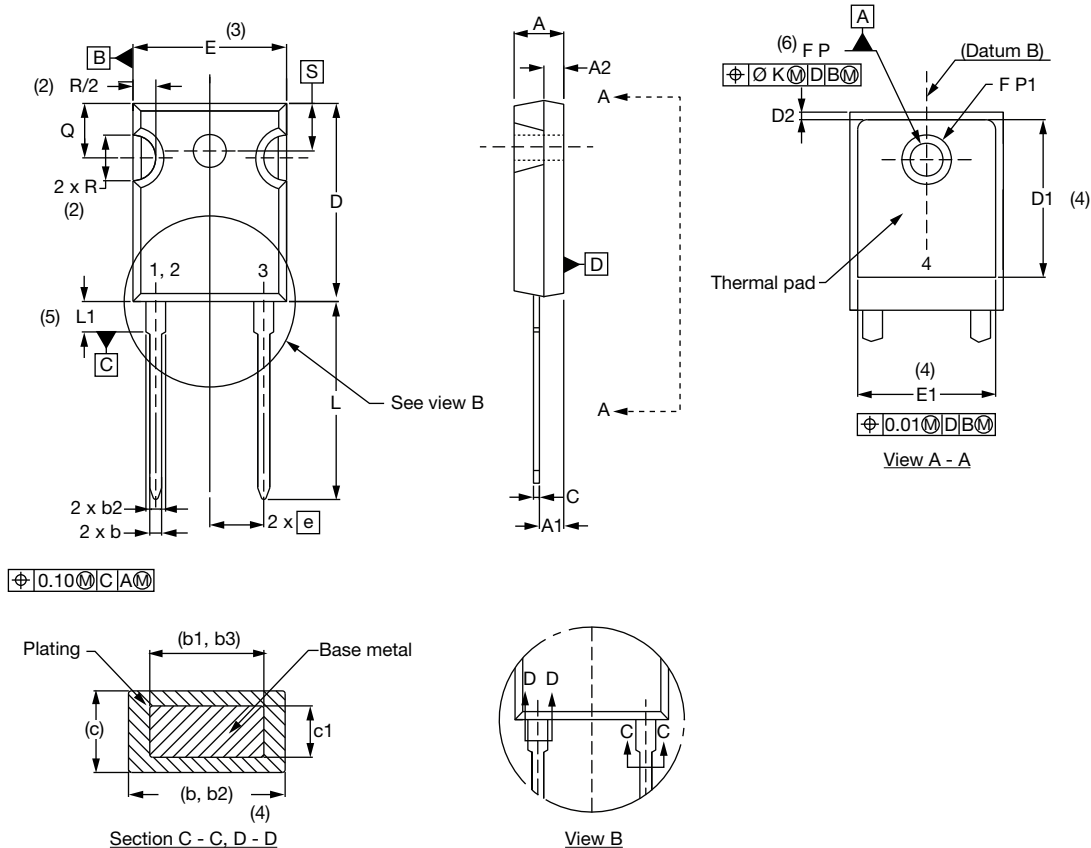

SYMBOL	MILLIMETERS		INCHES		NOTES	SYMBOL	MILLIMETERS		INCHES		NOTES
	MIN.	MAX.	MIN.	MAX.			MIN.	MAX.	MIN.	MAX.	
A	4.65	5.31	0.183	0.209		E	15.29	15.87	0.602	0.625	3
A1	2.21	2.59	0.087	0.102		E1	13.46	-	0.53	-	
A2	1.50	2.49	0.059	0.098		e	5.46 BSC		0.215 BSC		
b	0.99	1.40	0.039	0.055		Ø K	0.254		0.010		
b1	0.99	1.35	0.039	0.053		L	19.81	20.32	0.780	0.800	
b2	1.65	2.39	0.065	0.094		L1	3.71	4.29	0.146	0.169	
b3	1.65	2.34	0.065	0.092		Ø P	3.56	3.66	0.14	0.144	
c	0.38	0.89	0.015	0.035		Ø P1	-	6.98	-	0.275	
c1	0.38	0.84	0.015	0.033		Q	5.31	5.69	0.209	0.224	
D	19.71	20.70	0.776	0.815	3	R	4.52	5.49	0.178	0.216	
D1	13.08	-	0.515	-	4	S	5.51 BSC		0.217 BSC		
D2	0.51	1.35	0.020	0.053							

**Notes**

- (1) Dimensioning and tolerancing per ASME Y14.5M-1994
- (2) Contour of slot optional
- (3) Dimension D and E do not include mold flash. These dimensions are measured at the outermost extremes of the plastic body
- (4) Thermal pad contour optional with dimensions D1 and E1
- (5) Lead finish uncontrolled in L1
- (6) Ø P to have a maximum draft angle of 1.5 to the top of the part with a maximum hole diameter of 3.91 mm (0.154")
- (7) Outline conforms to JEDEC® outline TO-247 with exception of dimension A min., D, E min., Q min., S, and note 4



## Disclaimer

ALL PRODUCT, PRODUCT SPECIFICATIONS AND DATA ARE SUBJECT TO CHANGE WITHOUT NOTICE TO IMPROVE RELIABILITY, FUNCTION OR DESIGN OR OTHERWISE.

Vishay Intertechnology, Inc., its affiliates, agents, and employees, and all persons acting on its or their behalf (collectively, "Vishay"), disclaim any and all liability for any errors, inaccuracies or incompleteness contained in any datasheet or in any other disclosure relating to any product.

Vishay makes no warranty, representation or guarantee regarding the suitability of the products for any particular purpose or the continuing production of any product. To the maximum extent permitted by applicable law, Vishay disclaims (i) any and all liability arising out of the application or use of any product, (ii) any and all liability, including without limitation special, consequential or incidental damages, and (iii) any and all implied warranties, including warranties of fitness for particular purpose, non-infringement and merchantability.

Statements regarding the suitability of products for certain types of applications are based on Vishay's knowledge of typical requirements that are often placed on Vishay products in generic applications. Such statements are not binding statements about the suitability of products for a particular application. It is the customer's responsibility to validate that a particular product with the properties described in the product specification is suitable for use in a particular application. Parameters provided in datasheets and / or specifications may vary in different applications and performance may vary over time. All operating parameters, including typical parameters, must be validated for each customer application by the customer's technical experts. Product specifications do not expand or otherwise modify Vishay's terms and conditions of purchase, including but not limited to the warranty expressed therein.



Hyperlinks included in this datasheet may direct users to third-party websites. These links are provided as a convenience and for informational purposes only. Inclusion of these hyperlinks does not constitute an endorsement or an approval by Vishay of any of the products, services or opinions of the corporation, organization or individual associated with the third-party website. Vishay disclaims any and all liability and bears no responsibility for the accuracy, legality or content of the third-party website or for that of subsequent links.

Vishay products are not designed for use in life-saving or life-sustaining applications or any application in which the failure of the Vishay product could result in personal injury or death unless specifically qualified in writing by Vishay. Customers using or selling Vishay products not expressly indicated for use in such applications do so at their own risk. Please contact authorized Vishay personnel to obtain written terms and conditions regarding products designed for such applications.

No license, express or implied, by estoppel or otherwise, to any intellectual property rights is granted by this document or by any conduct of Vishay. Product names and markings noted herein may be trademarks of their respective owners.

## Looking for pricing, stock, or lifecycle information?

Click below to explore more details on WIN SOURCE:

-  [View VS-EPH3007L-N3 on WIN SOURCE](#)
-  [Vishay Information](#)

## Optimize Your Supply Chain with WIN SOURCE Solutions

-  Global Sourcing Solution
-  Obsolete Management
-  Cost Control Management
-  Shortage Management
-  Alternative Solution
-  Excess Inventory Management