



**THE DATASHEET OF
ISL80138IVEAJZ**



ISL80138

40V, High Accuracy, Low Quiescent Current, 150mA Linear Regulator

The [ISL80138](#) is a high voltage, adjustable V_{OUT} low quiescent current linear regulator ideally suited for “always-on” and “keep alive” applications. The ISL80138 operates from an input voltage of +6V to +40V under normal operating conditions and consumes only 18 μ A of quiescent current at no load.

The ISL80138 features an EN pin that can be used to put the device into a low-quiescent current shutdown mode where it draws only 2 μ A of supply current. The device features over-temperature shutdown and current limit protection.

The ISL80138 is rated to operate across the -40°C to +125°C temperature range and is available in a 14 lead HTSSOP with an exposed pad package.

Features

- Wide V_{IN} range of 6V to 40V
- Adjustable output voltage from 2.5V to 12V
- Ensured 150mA output current
- Ultra low 18 μ A typical quiescent current
- Low 2 μ A of typical shutdown current
- $\pm 1\%$ accurate voltage reference (over temperature, load)
- Low dropout voltage of 295mV at 150mA
- Low 26 μ V_{RMS} noise
- 40V tolerant logic level (TTL/CMOS) enable input
- Stable operation with 10 μ F output capacitor
- 5kV ESD HBM rated
- Thermal shutdown and current limit protection
- Thermally enhanced 14 Ld exposed pad HTSSOP package

Applications

- Industrial
- Telecommunications

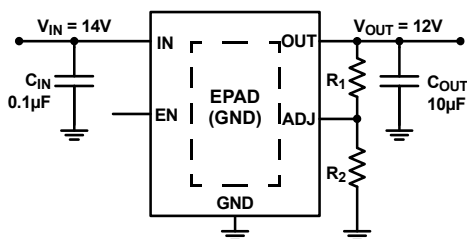

FIGURE 1. TYPICAL APPLICATION

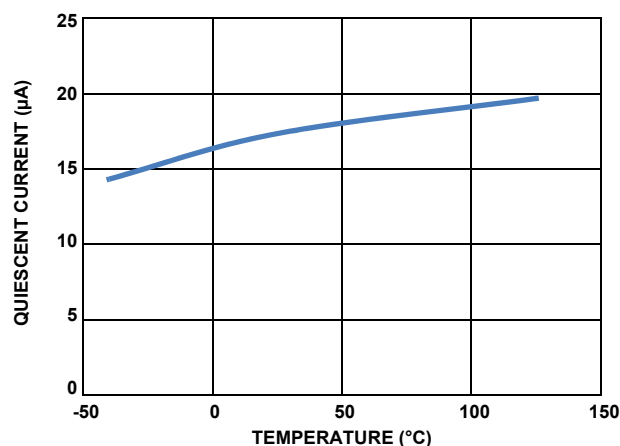
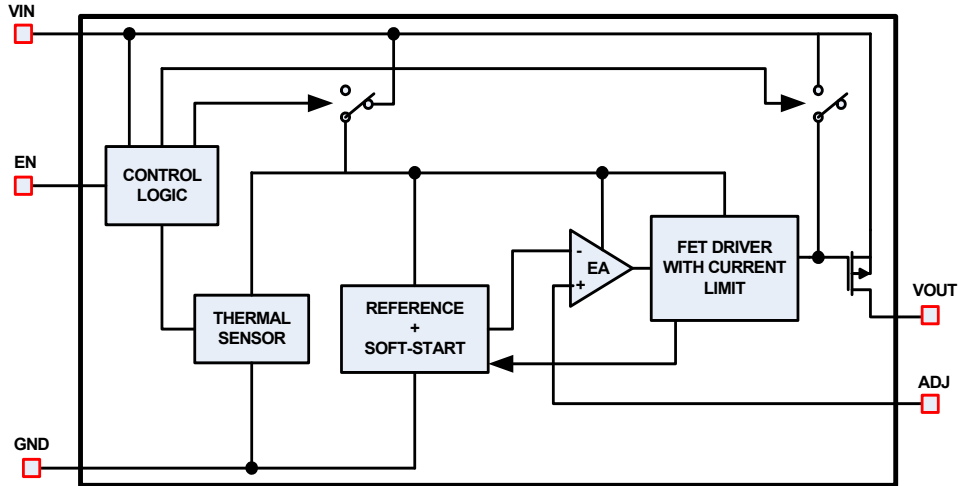

FIGURE 2. QUIESCENT CURRENT vs TEMPERATURE (AT UNITY GAIN). $V_{IN} = 14V$

Block Diagram



Ordering Information

| PART NUMBER (Notes 2, 3) | PART MARKING | ENABLE PIN | OUTPUT VOLTAGE (V) | PACKAGE (RoHS Compliant) | PKG. DWG. # | CARRIER TYPE (Note 1) | TEMP. RANGE (°C) |
|-----------------------------|---------------------|------------|--------------------|-----------------------------|-------------|--------------------------|---------------------|
| ISL80138IVEAJZ | 80138 | Yes | ADJ | 14 Ld HTSSOP | M14.173B | Tube | -40 to +125 |
| ISL80138IVEAJZ-T | IAJZ | | | | | Reel, 2.5k | |
| ISL80138EVAL1Z | Evaluation Platform | | | | | | |

NOTES:

1. See [TB347](#) for details about reel specifications.
2. These Pb-free plastic packaged products employ special Pb-free material sets, molding compounds/die attach materials, and 100% matte tin plate plus anneal (e3 termination finish, which is RoHS compliant and compatible with both SnPb and Pb-free soldering operations). Pb-free products are MSL classified at Pb-free peak reflow temperatures that meet or exceed the Pb-free requirements of IPC/JEDEC J STD-020.
3. For Moisture Sensitivity Level (MSL), see the [ISL80138](#) device page. For more information about MSL, see [TB363](#).

TABLE 1. KEY DIFFERENCES IN FAMILY OF 40V LDO PARTS

| PART NUMBER | MINIMUM I _{OUT} | IC PACKAGE |
|-------------|--------------------------|--------------|
| ISL80410 | 150mA | 8 Ld EPSOIC |
| ISL80136 | 50mA | 8 Ld EPSOIC |
| ISL80138 | 150mA | 14 LD HTSSOP |

Pin Configuration

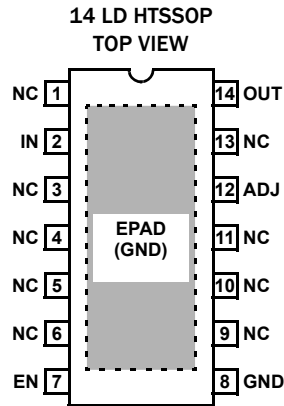

Pin Descriptions

| PIN NUMBER | PIN NAME | DESCRIPTION |
|------------------------------|----------|---|
| 1, 3, 4, 5, 6, 9, 10, 11, 13 | NC | Pins have internal termination and can be left unconnected. Connection to ground is optional. |
| 2 | IN | Input voltage pin. A minimum 0.1 μ F ceramic capacitor is required for proper operation. Range 6V to 40V. |
| 7 | EN | Enable pin. High on this pin enables the device. Range 0V to V_{IN} . |
| 8 | GND | Ground pin. |
| 12 | ADJ | This pin is connected to the external feedback resistor divider which sets the LDO output voltage. |
| 14 | OUT | Regulated output voltage. A 10 μ F ceramic capacitor is required for stability. Range 0V to 12V. |
| - | EPAD | It is recommended to solder the EPAD to the ground plane. |

Absolute Maximum Ratings

| | |
|--|-------------------|
| IN Pin to GND Voltage | GND - 0.3V to 45V |
| OUT Pin to GND Voltage | GND - 0.3V to 16V |
| ADJ Pin to GND Voltage | GND - 0.3V to 3V |
| EN Pin to GND Voltage | GND - 0.3V to VIN |
| Output Short-Circuit Duration | Indefinite |
| ESD Rating | |
| Human Body Model (Tested per JESD22-A114E) | 5kV |
| Machine Model (Tested per JESD-A115-A) | 200V |
| Charge Device Model (Tested per JESD22-C101C) | 2.2kV |
| Latch-Up (Tested per JESD78B; Class II, Level A) | 100mA |

Thermal Information

| | | |
|-----------------------------------|---------------------------|----------------------|
| Thermal Resistance (Typical) | θ_{JA} (°C/W) | θ_{JC} (°C/W) |
| 14 Ld HTSSOP Package (Notes 4, 5) | 37 | 5 |
| Maximum Junction Temperature | +150°C | |
| Maximum Storage Temperature Range | -65°C to +175°C | |
| Pb-Free Reflow Profile | see TB493 | |

Recommended Operating Conditions

| | |
|---------------------------|-----------------|
| Ambient Temperature Range | -40°C to +125°C |
| IN pin to GND Voltage | +6V to +40V |
| OUT pin to GND Voltage | +2.5V to +12V |
| EN pin to GND Voltage | 0V to +40V |

CAUTION: Do not operate at or near the maximum ratings listed for extended periods of time. Exposure to such conditions can adversely impact product reliability and result in failures not covered by warranty.

NOTES:

- θ_{JA} is measured in free air with the component mounted on a high-effective thermal conductivity test board with "direct attach" features. See [TB379](#).
- For θ_{JC} , the "case temp" location is the center of the exposed metal pad on the package underside.

Electrical Specifications Recommended Operating Conditions, unless otherwise noted. $V_{IN} = 14V$, $I_{OUT} = 1mA$, $T_A = T_J = -40^\circ C$ to $+125^\circ C$, unless otherwise noted. Typical specifications are at $T_A = +25^\circ C$. **Boldface limits apply across the operating temperature range, -40°C to +125°C.**

| PARAMETER | SYMBOL | TEST CONDITIONS | MIN (Note 8) | TYP | MAX (Note 8) | UNIT |
|------------------------------|---|---|-----------------|-------|-----------------|---------------|
| Input Voltage Range | V_{IN} | | 6 | | 40 | V |
| Guaranteed Output Current | I_{OUT} | $V_{IN} = V_{OUT} + V_{DO}$ | 150 | | | mA |
| ADJ Reference Voltage | V_{OUT} | EN = High, $V_{IN} = 14V$, $I_{OUT} = 0.1mA$ to 150mA | 1.211 | 1.223 | 1.235 | V |
| Line Regulation | $(V_{OUT \text{ low line}} - V_{OUT \text{ high line}}) / V_{OUT \text{ low line}}$ | $6V < V_{IN} < 40V$, $I_{OUT} = 1mA$ | | 0.04 | 0.15 | % |
| Load Regulation | $(V_{OUT \text{ no load}} - V_{OUT \text{ high load}}) / V_{OUT \text{ no load}}$ | $V_{IN} = 14V$, $I_{OUT} = 100\mu A$ to 150mA | | 0.3 | 0.6 | % |
| Dropout Voltage (Note 6) | ΔV_{DO} | $I_{OUT} = 1mA$, $V_{OUT} = 2.5V$ | | 7 | 33 | mV |
| | | $I_{OUT} = 150mA$, $V_{OUT} = 2.5V$ | | 380 | 571 | mV |
| | | $I_{OUT} = 1mA$, $V_{OUT} = 5V$ | | 7 | 33 | mV |
| | | $I_{OUT} = 150mA$, $V_{OUT} = 5V$ | | 295 | 507 | mV |
| Shutdown Current | I_{SHDN} | EN = LOW | | 2 | 3.64 | μA |
| Quiescent Current | I_Q | EN = HIGH, $I_{OUT} = 0mA$ | | 18 | 24 | μA |
| | | EN = HIGH, $I_{OUT} = 1mA$ | | 22 | 42 | μA |
| | | EN = HIGH, $I_{OUT} = 10mA$ | | 34 | 60 | μA |
| | | EN = HIGH, $I_{OUT} = 150mA$ | | 90 | 125 | μA |
| Power Supply Rejection Ratio | PSRR | $f = 100Hz$; $V_{IN_RIPPLE} = 500mV_{p-p}$; Load = 150mA | | 66 | | dB |
| Output Voltage Noise | | $V_{IN} = 14V$, $V_{OUT} = 3.3V$, $C_{OUT} = 10\mu F$, $I_{OUT} = 10mA$, BW = 100Hz to 100kHz | | 26 | | μV_{RMS} |

Electrical Specifications Recommended Operating Conditions, unless otherwise noted. $V_{IN} = 14V$, $I_{OUT} = 1mA$, $T_A = T_J = -40^\circ C$ to $+125^\circ C$, unless otherwise noted. Typical specifications are at $T_A = +25^\circ C$. **Boldface limits apply across the operating temperature range, $-40^\circ C$ to $+125^\circ C$.** (Continued)

| PARAMETER | SYMBOL | TEST CONDITIONS | MIN (Note 8) | TYP | MAX (Note 8) | UNIT |
|-----------------------------------|-------------|------------------------------|-----------------|-------|-----------------|------------|
| EN FUNCTION | | | | | | |
| EN Threshold Voltage | V_{EN_H} | $V_{OUT} = \text{Off to On}$ | | | 1.485 | V |
| | V_{EN_L} | $V_{OUT} = \text{On to Off}$ | 0.975 | | | V |
| EN Pin Current | I_{EN} | $V_{OUT} = 0V$ | | 0.026 | | μA |
| EN to Regulation Time (Note 7) | t_{EN} | | | 1.65 | 1.93 | ms |
| PROTECTION FEATURES | | | | | | |
| Output Current Limit | I_{LIMIT} | $V_{OUT} = 0V$ | 175 | 410 | | mA |
| Thermal Shutdown | T_{SHDN} | Junction Temperature Rising | | +165 | | $^\circ C$ |
| Thermal Shutdown Hysteresis | T_{HYST} | | | +20 | | $^\circ C$ |

NOTES:

- Dropout voltage is defined as $(V_{IN} - V_{OUT})$ when V_{OUT} is 2% below the value of V_{OUT} .
- Enable to Regulation Time is the time the output takes to reach 95% of its final value with $V_{IN} = 14V$ and EN is taken from V_{IL} to V_{IH} in 5ns. For the adjustable versions, the output voltage is set at 5V.
- Parameters with MIN and/or MAX limits are 100% tested at $+25^\circ C$, unless otherwise specified. Temperature limits established by characterization and are not production tested.

Typical Performance Curves

$V_{IN} = 14V$, $I_{OUT} = 1mA$, $V_{OUT} = 5V$, $T_J = +25^\circ C$, unless otherwise specified.

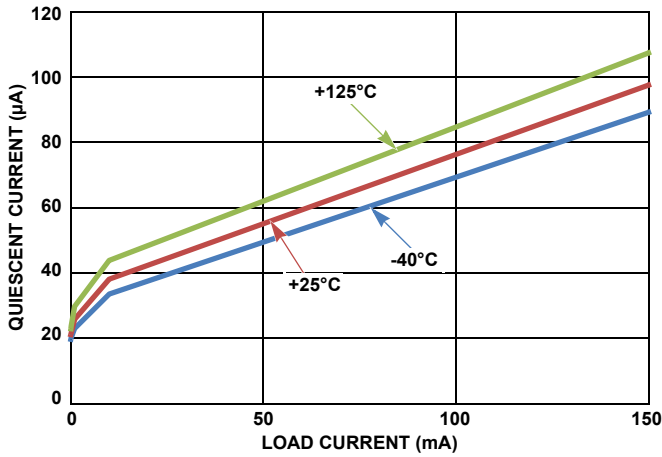

FIGURE 3. QUIESCENT CURRENT vs LOAD CURRENT

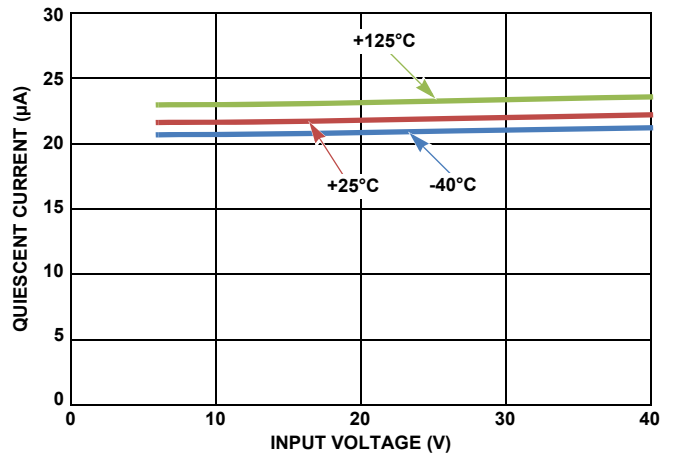

FIGURE 4. QUIESCENT CURRENT vs INPUT VOLTAGE (NO LOAD)

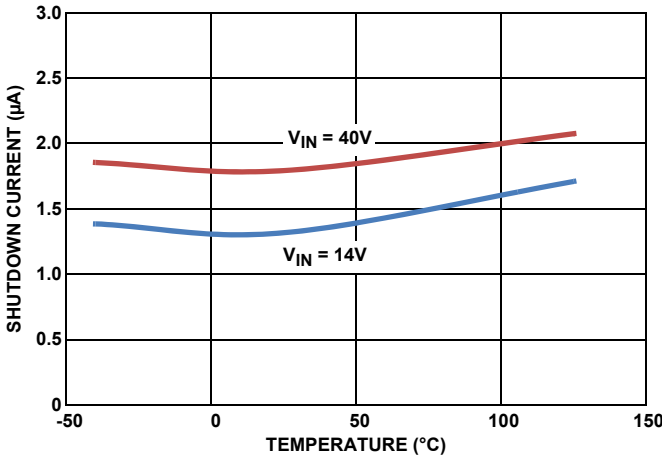

FIGURE 5. SHUTDOWN CURRENT vs TEMPERATURE (EN = 0)

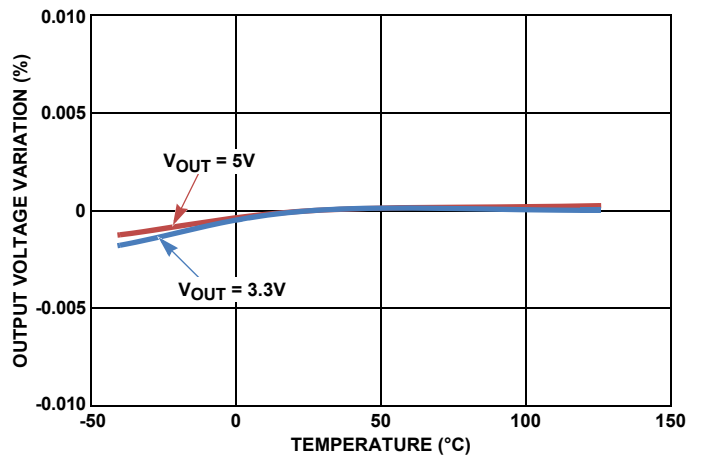

FIGURE 6. OUTPUT VOLTAGE vs TEMPERATURE (LOAD = 50mA)

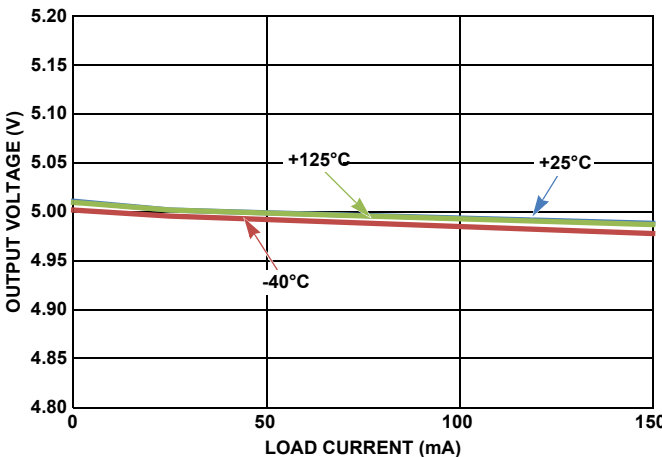

FIGURE 7. OUTPUT VOLTAGE vs LOAD CURRENT

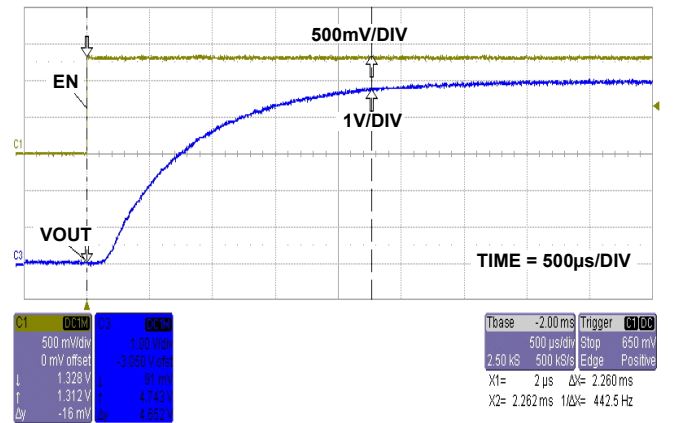

FIGURE 8. START-UP WAVEFORM

Typical Performance Curves $V_{IN} = 14V, I_{OUT} = 1mA, V_{OUT} = 5V, T_J = +25^{\circ}C$, unless otherwise specified. (Continued)

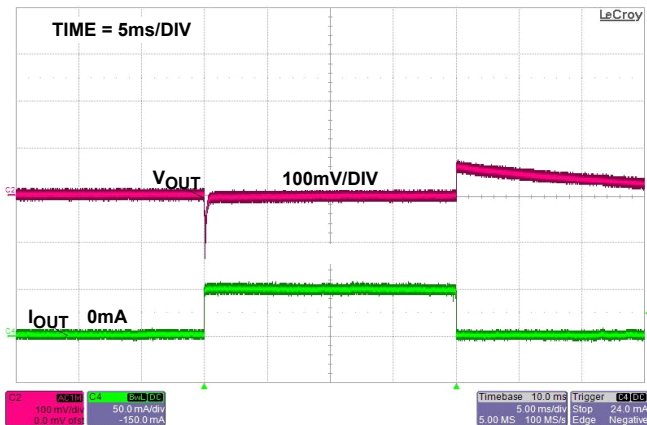

FIGURE 9. LOAD TRANSIENT RESPONSE

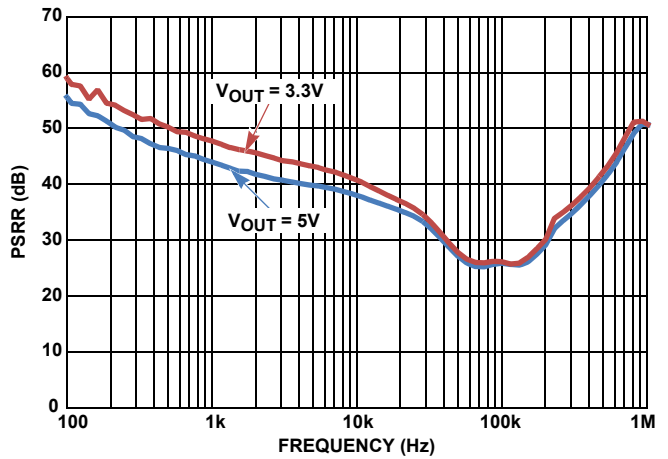

FIGURE 10. PSRR vs FREQUENCY FOR VARIOUS OUTPUT VOLTAGES, (LOAD = 150mA)

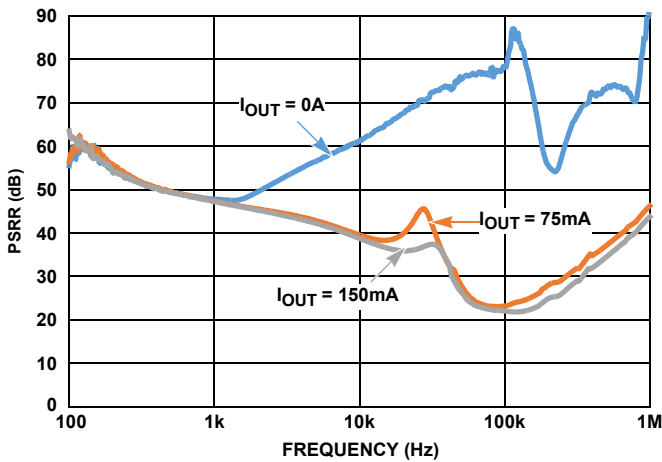

FIGURE 11. PSRR vs FREQUENCY FOR VARIOUS LOAD CURRENTS, $V_{OUT} = 3.3V$

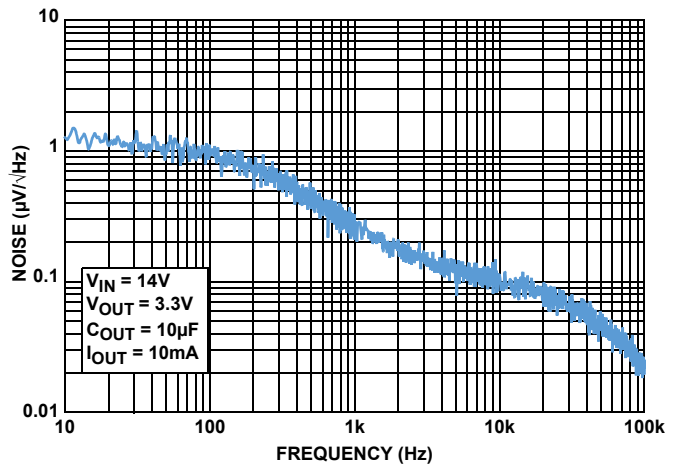

FIGURE 12. OUTPUT NOISE SPECTRAL DENSITY, $I_{OUT} = 10mA$

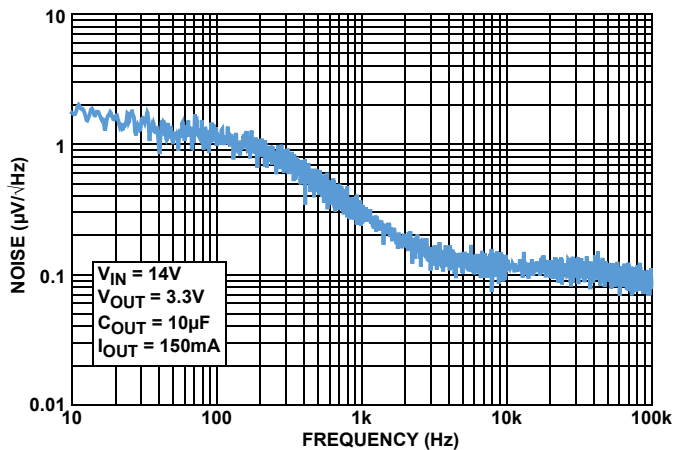

FIGURE 13. OUTPUT NOISE SPECTRAL DENSITY, $I_{OUT} = 150mA$

Functional Description

Functional Overview

The ISL80138 is a high performance, high voltage, low-dropout regulator (LDO) with 150mA sourcing capability. The part is rated to operate across the -40°C to $+125^{\circ}\text{C}$ temperature range. Featuring ultra-low quiescent current, it is an ideal choice for “always-on” applications. It works well under a “load dump condition” where the input voltage could rise up to 40V. This LDO device also features current limit and thermal shutdown protection.

Enable Control

The ISL80138 has an enable pin that turns the device on when pulled high. When EN is low, the IC goes into shutdown mode and draws less than $2\mu\text{A}$ of current. Tie the EN pin to IN for “always-on” operation.

Current Limit Protection

The ISL80138 has internal current limiting functionality to protect the regulator during fault conditions. During current limit, the output sources a fixed amount of current largely independent of the output voltage. If the short or overload is removed from V_{OUT} , the output returns to normal voltage regulation mode.

Thermal Fault Protection

If the die temperature exceeds a typical value of $+165^{\circ}\text{C}$, the output of the LDO shuts down until the die temperature cools down to a typical $+145^{\circ}\text{C}$. The level of power dissipated, combined with the ambient temperature and the thermal impedance of the package, determines if the junction temperature exceeds the thermal shutdown temperature. See “[Power Dissipation](#)” for more details.

Application Information

Input and Output Capacitors

A minimum $0.1\mu\text{F}$ ceramic capacitor is recommended at the input for proper operation. For the output, a ceramic capacitor with a capacitance of $10\mu\text{F}$ is recommended for the ISL80138 to maintain stability. Route the ground connection of the output capacitor directly to the GND pin of the device and place it close to the IC.

Output Voltage Setting

The ISL80138 output voltage is programmed using an external resistor divider as shown in [Figure 14](#).

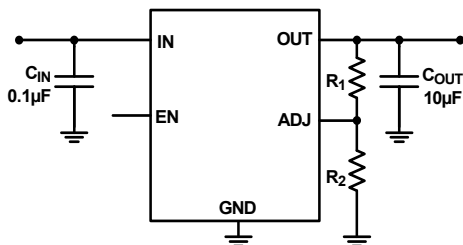

FIGURE 14. OUTPUT VOLTAGE SETTING

The output voltage is calculated using [Equation 1](#):

$$V_{\text{OUT}} = 1.223\text{V} \times \left(\frac{R_1}{R_2} + 1 \right) \quad (\text{EQ. 1})$$

Power Dissipation

The junction temperature must not exceed the range specified in “[Recommended Operating Conditions](#)” on [page 4](#). The power dissipation can be calculated using [Equation 2](#):

$$P_{\text{D}} = (V_{\text{IN}} - V_{\text{OUT}}) \times I_{\text{OUT}} + V_{\text{IN}} \times I_{\text{GND}} \quad (\text{EQ. 2})$$

The maximum allowable junction temperature, $T_{\text{J}(\text{MAX})}$ and the maximum expected ambient temperature, $T_{\text{A}(\text{MAX})}$ determine the maximum allowable junction temperature rise (ΔT_{J}), as shown in [Equation 3](#):

$$\Delta T_{\text{J}} = T_{\text{J}(\text{MAX})} - T_{\text{A}(\text{MAX})} \quad (\text{EQ. 3})$$

To calculate the maximum ambient operating temperature, use the junction-to-ambient thermal resistance (θ_{JA}) as shown in [Equation 4](#):

$$T_{\text{J}(\text{MAX})} = P_{\text{D}(\text{MAX})} \times \theta_{\text{JA}} + T_{\text{A}} \quad (\text{EQ. 4})$$

Board Layout Recommendations

A good PCB layout is important to achieve expected performance. When placing the components and routing the trace, minimize the ground impedance and keep the parasitic inductance low. The input and output capacitors should have a good ground connection and be placed as close to the IC as possible. The feedback trace in the adjustable version should be away from other noisy traces. The 14 Ld HTSSOP package uses the copper area on the PCB as a heat sink. The EPAD of this package must be soldered to the copper plane (GND plane) for effective heat dissipation. [Figure 15](#) shows a curve for θ_{JA} of the package for different copper area sizes.

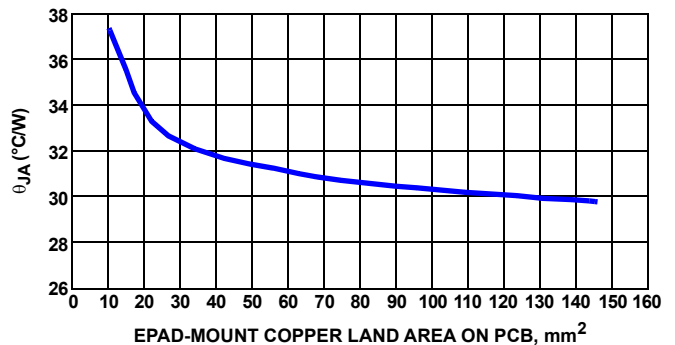

FIGURE 15. θ_{JA} vs EPAD-MOUNT COPPER LAND AREA ON PCB

Revision History

The revision history provided is for informational purposes only and is believed to be accurate, but not warranted. Please go to web to make sure you have the latest Rev.

| DATE | REVISION | CHANGE |
|--------------|----------|--|
| Aug 10, 2023 | 2.01 | Updated Ordering Information section. Removed Related literature section. |
| Feb 20, 2019 | 2.00 | Updated title Updated the 6th bullet and added the 8th bullet in the features list. Updated Related Literature section. Updated ordering information table with tape and reel information and updated notes. Updated Table 1 and moved to page 2. Added Output Voltage Noise specification. Removed About Intersil section. Updated disclaimer |
| Jan 15, 2016 | 1.00 | Updated entire datasheet applying Intersil's new standards. On page 1, updated Key Differences Table, Replaced "ADJ OR FIXED VOUT" Column with "IC PACKAGE" column. On page 2, updated Block Diagram, removed two resistors and switched polarity of EA. On page 3, removed "Range 0V to 3V." from the ADJ Pin Description On page 4, updated Note 4 from " θ_{JA} is measured with the component mounted on a high effective thermal conductivity test board in free air. See Tech Brief TB379 for details." to " θ_{JA} is measured in free air with the component mounted on a high effective thermal conductivity test board with "direct attach" features. See Tech Brief TB379." On page 4, removed " $C_{IN} = 0.1\mu F$, $C_{OUT} = 10\mu F$ " from the Electrical Specification heading. On page 4, updated the Line Regulation -Symbol, from " $\Delta V_{OUT}/\Delta V_{IN}$ " to " $(V_{OUT} \text{ low line} - V_{OUT} \text{ high line})/V_{OUT} \text{ low line}$ ". -Test Conditions, from " $3V \leq V_{IN} \leq 40V$, $I_{OUT} = 1mA$ " to " $6V < V_{IN} < 40V$, $I_{OUT} = 1mA$ " On page 4, updated the Load Regulation -Symbol, from " $\Delta V_{OUT}/\Delta I_{OUT}$ " to " $(V_{OUT} \text{ no load} - V_{OUT} \text{ high load})/V_{OUT} \text{ no load}$ ". -Test Conditions from " $V_{IN} = V_{OUT} + V_{DO}$ " to " $V_{IN} = 14V$ " On page 3, updated the Dropout Voltage (Two rows only): -Test Conditions from " $V_{OUT} = 3.3V$ " to " $V_{OUT} = 2.5V$ " -Changed maximum value for condition, $I_{OUT} = 150mA$, $V_{OUT} = 2.5V$, from "525" to "571" -Changed maximum value for condition, $I_{OUT} = 150mA$, $V_{OUT} = 5V$, from "460" to "507" Updated Note 6 from "Dropout voltage is defined as $(V_{IN} - V_{OUT})$ when V_{OUT} is 2% below the value of V_{OUT} when $V_{IN} = V_{OUT} + 3V$." to "Dropout voltage is defined as $(V_{IN} - V_{OUT})$ when V_{OUT} is 2% below the value of V_{OUT} ." On page 7, switched Figures 9 and 10 location, then updated title for Figure 10 from "POWER SUPPLY REJECTION RATIO (LOAD = 150mA)" to "PSRR vs FREQUENCY FOR VARIOUS OUTPUT VOLTAGES (LOAD = 150mA)" Added Figures 11, 12 and 13 on page 7. Updated Products verbiage to About Intersil verbiage. |
| Jan 11, 2012 | 0.00 | Initial Release. |

Package Outline Drawing

For the most recent package outline drawing, see [M14.173B](#).

M14.173B

14 LEAD HEAT-SINK THIN SHRINK SMALL OUTLINE PACKAGE (HTSSOP)

Rev 1, 1/10

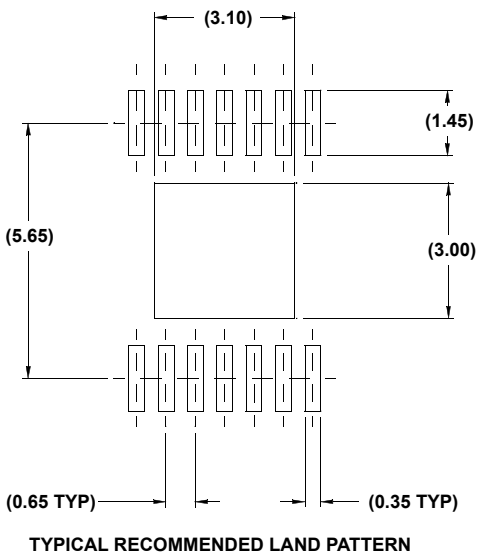
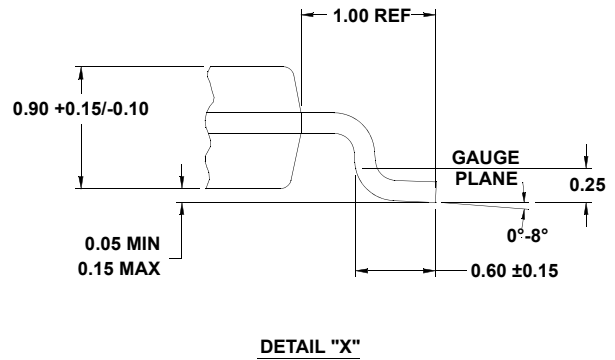
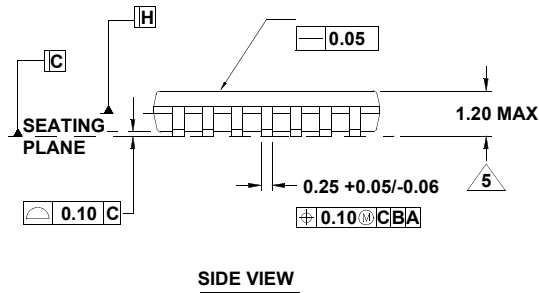
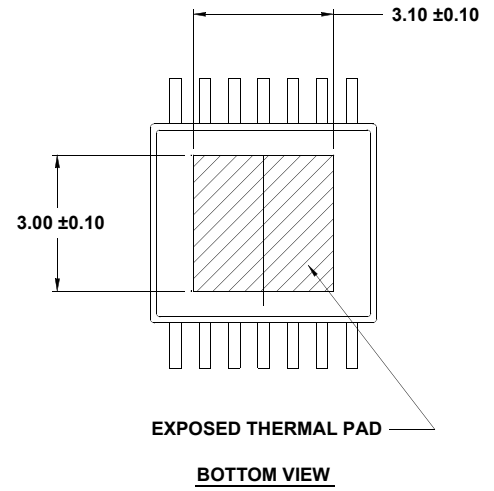
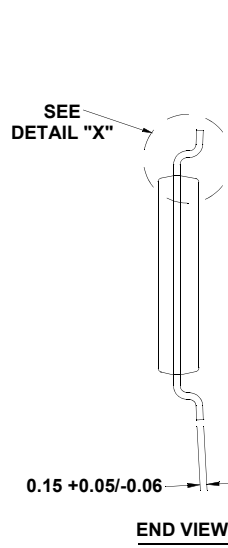
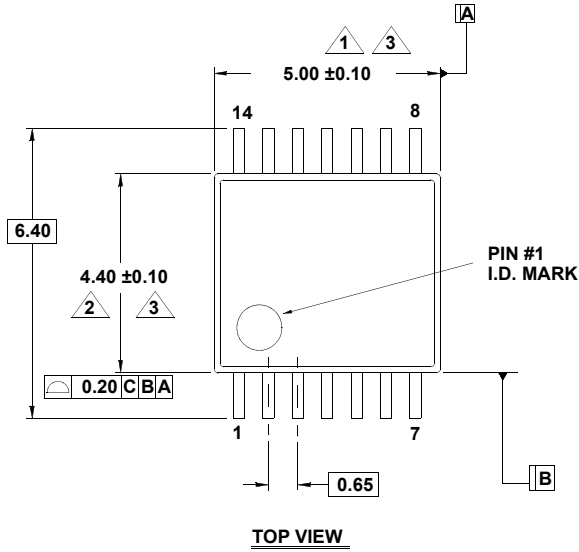

NOTES:

1. Dimension does not include mold flash, protrusions or gate burrs. Mold flash, protrusions or gate burrs shall not exceed 0.15 per side.
2. Dimension does not include interlead flash or protrusion. Interlead flash or protrusion shall not exceed 0.25 per side.
3. Dimensions are measured at datum plane H.
4. Dimensioning and tolerancing per ASME Y14.5M-1994.
5. Dimension does not include dambar protrusion. Allowable protrusion shall be 0.80mm total in excess of dimension at maximum material condition. Minimum space between protrusion and adjacent lead is 0.07mm.
6. Dimension in () are for reference only.
7. Conforms to JEDEC MO-153, variation ABT-1.

IMPORTANT NOTICE AND DISCLAIMER

RENESAS ELECTRONICS CORPORATION AND ITS SUBSIDIARIES (“RENESAS”) PROVIDES TECHNICAL SPECIFICATIONS AND RELIABILITY DATA (INCLUDING DATASHEETS), DESIGN RESOURCES (INCLUDING REFERENCE DESIGNS), APPLICATION OR OTHER DESIGN ADVICE, WEB TOOLS, SAFETY INFORMATION, AND OTHER RESOURCES “AS IS” AND WITH ALL FAULTS, AND DISCLAIMS ALL WARRANTIES, EXPRESS OR IMPLIED, INCLUDING, WITHOUT LIMITATION, ANY IMPLIED WARRANTIES OF MERCHANTABILITY, FITNESS FOR A PARTICULAR PURPOSE, OR NON-INFRINGEMENT OF THIRD PARTY INTELLECTUAL PROPERTY RIGHTS.

These resources are intended for developers skilled in the art designing with Renesas products. You are solely responsible for (1) selecting the appropriate products for your application, (2) designing, validating, and testing your application, and (3) ensuring your application meets applicable standards, and any other safety, security, or other requirements. These resources are subject to change without notice. Renesas grants you permission to use these resources only for development of an application that uses Renesas products. Other reproduction or use of these resources is strictly prohibited. No license is granted to any other Renesas intellectual property or to any third party intellectual property. Renesas disclaims responsibility for, and you will fully indemnify Renesas and its representatives against, any claims, damages, costs, losses, or liabilities arising out of your use of these resources. Renesas' products are provided only subject to Renesas' Terms and Conditions of Sale or other applicable terms agreed to in writing. No use of any Renesas resources expands or otherwise alters any applicable warranties or warranty disclaimers for these products.

(Disclaimer Rev.1.0 Mar 2020)

Corporate Headquarters

TOYOSU FORESIA, 3-2-24 Toyosu,
Koto-ku, Tokyo 135-0061, Japan
www.renesas.com

Contact Information

For further information on a product, technology, the most up-to-date version of a document, or your nearest sales office, please visit:
www.renesas.com/contact/

Trademarks

Renesas and the Renesas logo are trademarks of Renesas Electronics Corporation. All trademarks and registered trademarks are the property of their respective owners.

Looking for pricing, stock, or lifecycle information?

Click below to explore more details on WIN SOURCE:

-  [View ISL80138IVEAJZ on WIN SOURCE](#)
-  [Renesas Electronics America](#) Information

Optimize Your Supply Chain with WIN SOURCE Solutions

-  Global Sourcing Solution
-  Obsolete Management
-  Cost Control Management
-  Shortage Management
-  Alternative Solution
-  Excess Inventory Management