



**THE DATASHEET OF  
DMP3099LQ-13**



## Product Summary

BV <sub>DSS</sub>	R <sub>DS(ON)</sub> max	I <sub>D</sub> max T <sub>A</sub> = +25°C
-30V	65mΩ @ V <sub>GS</sub> = -10V	-3.8A
	99mΩ @ V <sub>GS</sub> = -4.5V	-3.0A

## Description and Applications

This MOSFET is designed to meet the stringent requirements of Automotive applications. It is qualified to AEC-Q101, supported by a PPAP and is ideal for use in:

- Backlighting
- Power Management Functions
- DC-DC Converters

## Features and Benefits

- Low Gate Threshold Voltage
- Low Input Capacitance
- Fast Switching Speed
- Low Input/Output Leakage
- **Totally Lead-Free & Fully RoHS Compliant (Notes 1 & 2)**
- **Halogen and Antimony Free. "Green" Device (Note 3)**
- **Qualified to AEC-Q101 Standards for High Reliability**
- **PPAP Capable (Note 4)**

## Mechanical Data

- Case: SOT23
- Case Material: Molded Plastic, "Green" Molding Compound. UL Flammability Classification Rating 94V-0
- Moisture Sensitivity: Level 1 per J-STD-020
- Terminals: Finish — Matte Tin Annealed over Copper Leadframe. Solderable per MIL-STD-202, Method 208 **e3**
- Terminal Connections: See Diagram
- Weight: 0.009 grams (Approximate)

SOT23



Top View

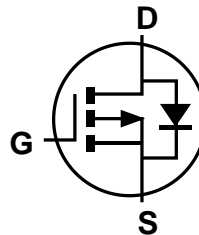

Equivalent Circuit

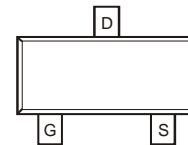

Top View  
Pin Configuration

## Ordering Information (Note 5)

Part Number	Case	Packaging
DMP3099LQ-7	SOT23	3000/Tape & Reel
DMP3099LQ-13	SOT23	10000/Tape & Reel

- Notes:
1. No purposely added lead. Fully EU Directive 2002/95/EC (RoHS) & 2011/65/EU (RoHS 2) compliant.
  2. See [http://www.diodes.com/quality/lead\\_free.html](http://www.diodes.com/quality/lead_free.html) for more information about Diodes Incorporated's definitions of Halogen- and Antimony-free, "Green" and Lead-free.
  3. Halogen- and Antimony-free "Green" products are defined as those which contain <900ppm bromine, <900ppm chlorine (<1500ppm total Br + Cl) and <1000ppm antimony compounds.
  4. Automotive products are AEC-Q101 qualified and are PPAP capable. Refer to <https://www.diodes.com/quality/product-compliance-definitions/>.
  5. For packaging details, go to our website at <https://www.diodes.com/design/support/packaging/diodes-packaging/>.

## Marking Information

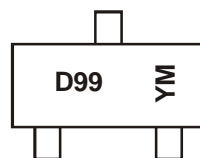

D99 = Product Type Marking Code  
 YM = Date Code Marking  
 Y = Year (ex: E = 2017)  
 M = Month (ex: 9 = September)

### Date Code Key

Year	2016	2017	2018	2019	2020	2021	2022	2023
Code	D	E	F	G	H	I	J	K

Month	Jan	Feb	Mar	Apr	May	Jun	Jul	Aug	Sep	Oct	Nov	Dec
Code	1	2	3	4	5	6	7	8	9	O	N	D

**Maximum Ratings** (@T<sub>A</sub> = +25°C, unless otherwise specified.)

Characteristic			Symbol	Value	Unit
Drain-Source Voltage			V <sub>DSS</sub>	-30	V
Gate-Source Voltage			V <sub>GSS</sub>	±20	V
Drain Current (Note 6) V <sub>GS</sub> = -10V	Steady State	T <sub>A</sub> = +25°C	I <sub>D</sub>	-3.8	A
		T <sub>A</sub> = +70°C		-2.9	
Pulsed Drain Current (Note 7)			I <sub>DM</sub>	-11	A
Avalanche Current, L = 0.1mH			I <sub>AS</sub>	-14.3	A
Avalanche Energy, L = 0.1mH			E <sub>AS</sub>	10.2	mJ

**Thermal Characteristics**

Characteristic	Symbol	Value	Unit
Total Power Dissipation (Note 6)	P <sub>D</sub>	1.08	W
Thermal Resistance, Junction to Ambient @T <sub>A</sub> = +25°C (Note 6)	R <sub>θJA</sub>	115	°C/W
Operating and Storage Temperature Range	T <sub>J</sub> , T <sub>STG</sub>	-55 to +150	°C

**Electrical Characteristics** (@T<sub>A</sub> = +25°C, unless otherwise specified.)

Characteristic	Symbol	Min	Typ	Max	Unit	Test Condition
<b>OFF CHARACTERISTICS (Note 8)</b>						
Drain-Source Breakdown Voltage	BV <sub>DSS</sub>	-30	—	—	V	V <sub>GS</sub> = 0V, I <sub>D</sub> = -250μA
Zero Gate Voltage Drain Current	I <sub>DSS</sub>	—	—	-800	nA	V <sub>DS</sub> = -30V, V <sub>GS</sub> = 0V
Gate-Source Leakage	I <sub>GSS</sub>	—	—	±100	nA	V <sub>GS</sub> = ±20V, V <sub>DS</sub> = 0V
<b>ON CHARACTERISTICS (Note 8)</b>						
Gate Threshold Voltage	V <sub>GS(TH)</sub>	-1.0	—	-2.1	V	V <sub>DS</sub> = V <sub>GS</sub> , I <sub>D</sub> = -250μA
Static Drain-Source On-Resistance	R <sub>DS(ON)</sub>	—	—	65	mΩ	V <sub>GS</sub> = -10V, I <sub>D</sub> = -3.8A
				99		V <sub>GS</sub> = -4.5V, I <sub>D</sub> = -3.0A
Forward Transfer Admittance	Y <sub>fs</sub>	—	3.6	—	S	V <sub>DS</sub> = -5V, I <sub>D</sub> = -2.7A
Diode Forward Voltage	V <sub>SD</sub>	—	—	-1.26	V	V <sub>GS</sub> = 0V, I <sub>S</sub> = -2.7A
<b>DYNAMIC CHARACTERISTICS (Note 9)</b>						
Input Capacitance	C <sub>iss</sub>	—	563	—	pF	V <sub>DS</sub> = -25V, V <sub>GS</sub> = 0V, f = 1.0MHz
Output Capacitance	C <sub>oss</sub>	—	48	—	pF	
Reverse Transfer Capacitance	C <sub>rss</sub>	—	41	—	pF	
Gate Resistance	R <sub>G</sub>	—	10.3	—	Ω	V <sub>GS</sub> = 0V, V <sub>DS</sub> = 0V, f = 1MHz
<b>SWITCHING CHARACTERISTICS (Note 9)</b>						
Total Gate Charge	Q <sub>g</sub>	—	5.2	—	nC	V <sub>DS</sub> = -15V, V <sub>GS</sub> = -4.5V, I <sub>D</sub> = -3.8A
			11			
Gate-Source Charge	Q <sub>gs</sub>	—	1.7	—		V <sub>DS</sub> = -15V, V <sub>GS</sub> = -10V, I <sub>D</sub> = -3.8A
Gate-Drain Charge	Q <sub>gd</sub>	—	1.9			
Turn-On Delay Time	t <sub>D(ON)</sub>	—	4.8	ns	V <sub>DS</sub> = -15V, V <sub>GS</sub> = -10V, I <sub>D</sub> = -1A, R <sub>G</sub> = 6.0Ω	
Rise Time	t <sub>R</sub>	—	5.0			
Turn-Off Delay Time	t <sub>D(OFF)</sub>	—	31			
Fall Time	t <sub>F</sub>	—	15			

- Notes:
6. Device mounted on FR-4 PCB on 2 oz., 0.5 inch<sup>2</sup> copper pads and t ≤ 5 sec.
  7. Pulse width ≤ 10μs, Duty Cycle ≤ 1%.
  8. Short duration pulse test used to minimize self-heating effect.
  9. Guaranteed by design. Not subject to production testing.

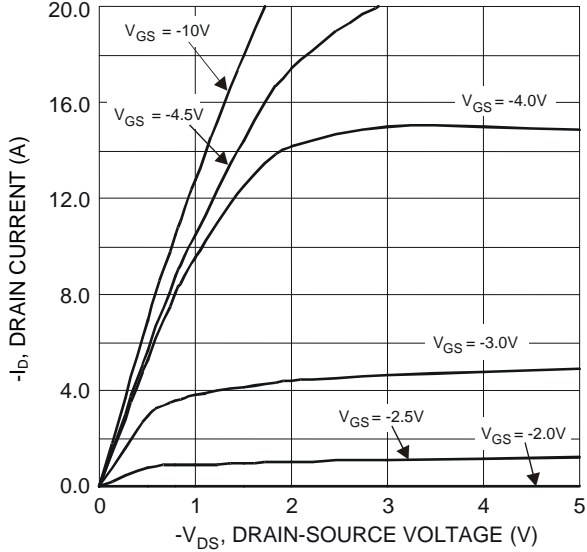

Figure 1 Typical Output Characteristics

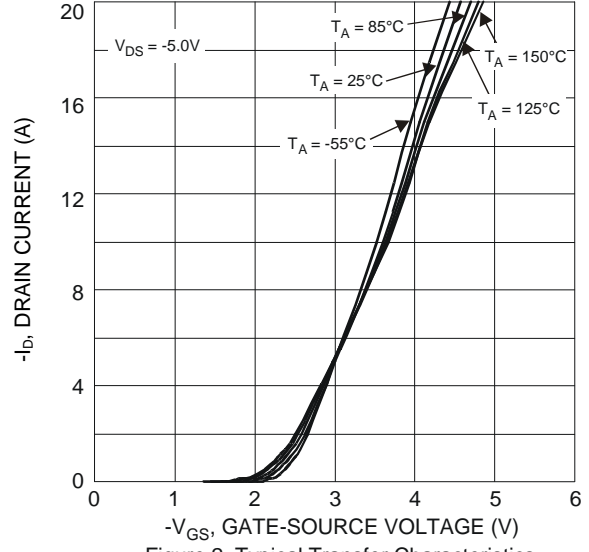

Figure 2 Typical Transfer Characteristics

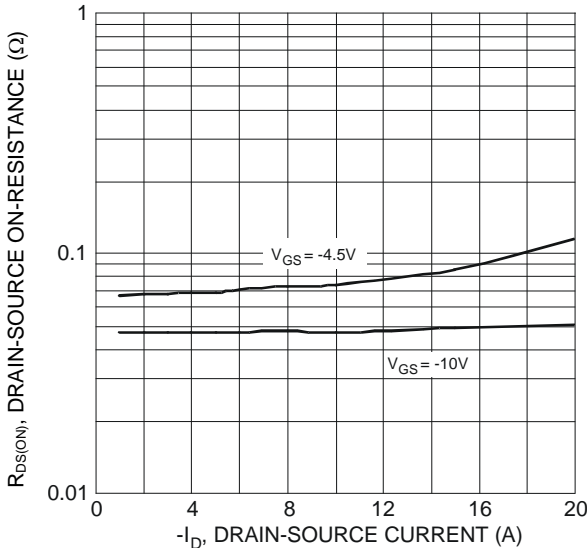

Figure 3 Typical On-Resistance vs. Drain Current and Gate Voltage

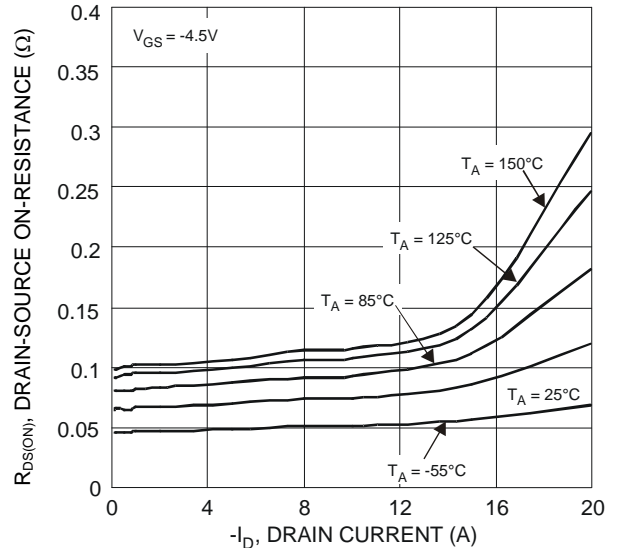

Figure 4 Typical On-Resistance vs. Drain Current and Temperature

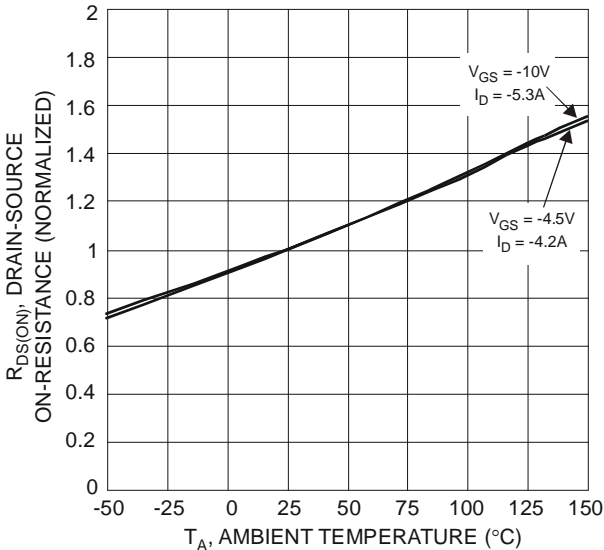

Figure 5 On-Resistance Variation with Temperature

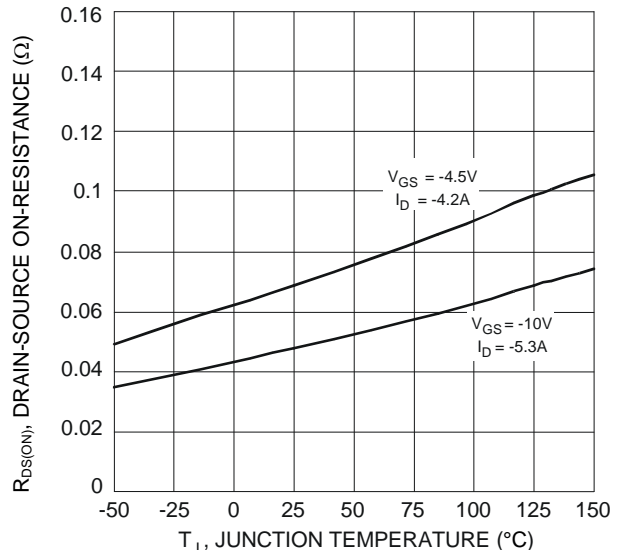

Figure 6 On-Resistance Variation with Temperature

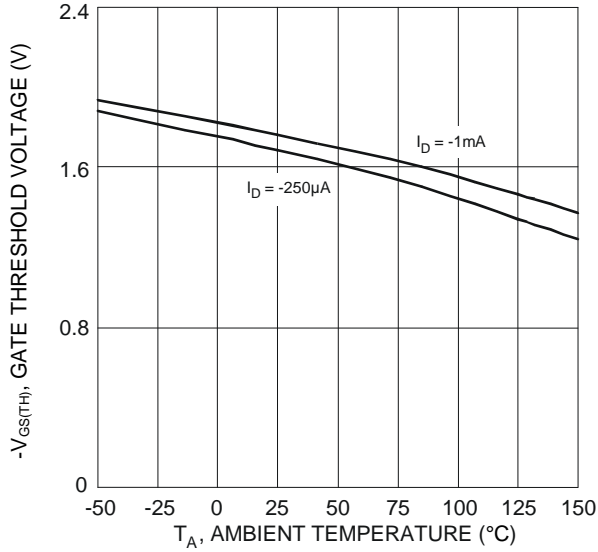

Figure 7 Gate Threshold Variation vs. Ambient Temperature

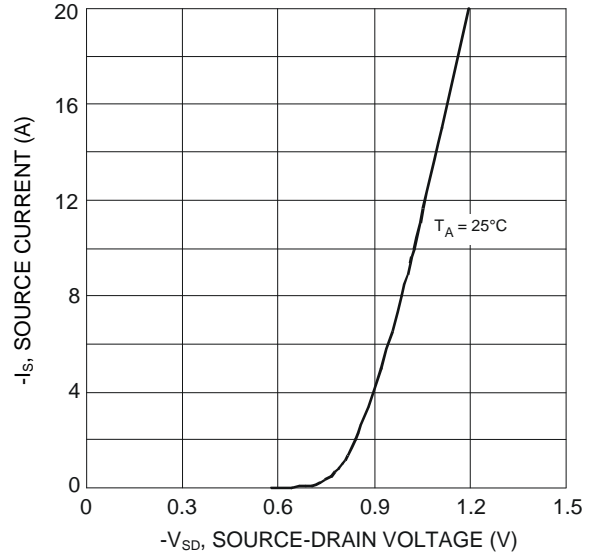

Figure 8 Diode Forward Voltage vs. Current

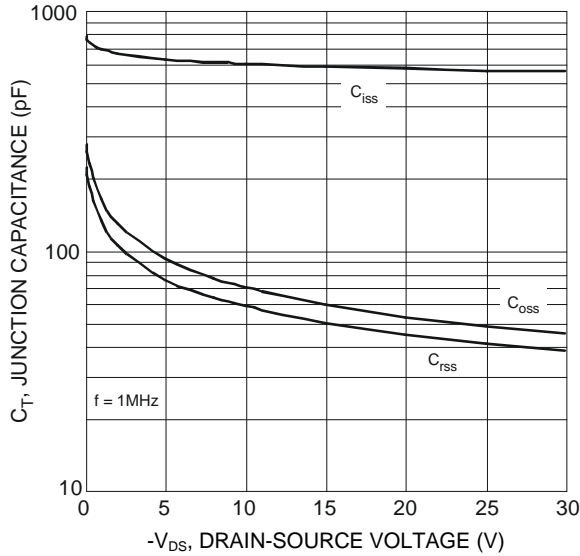

Figure 9 Typical Junction Capacitance

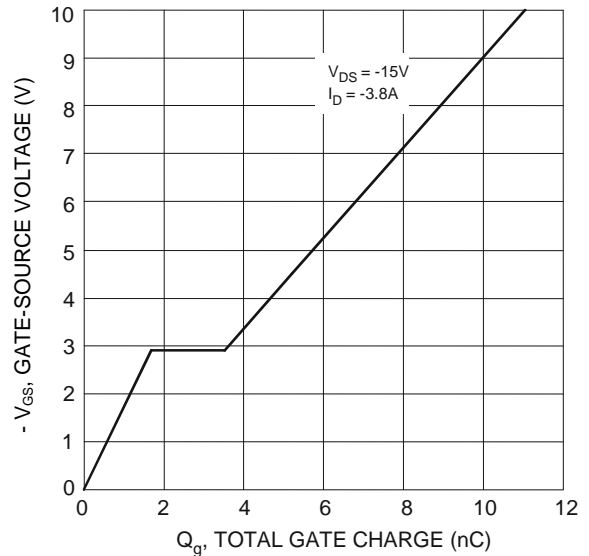
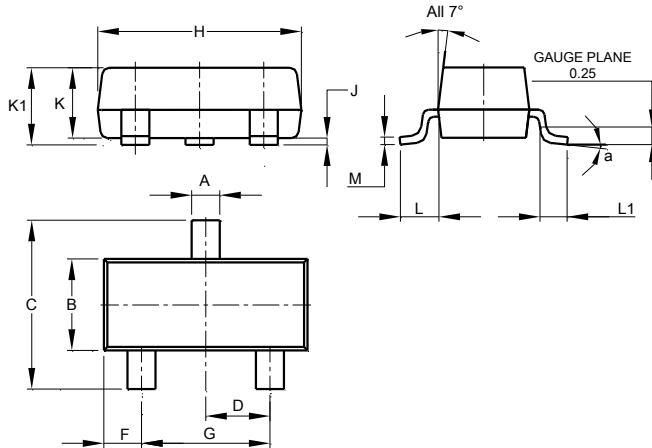

Figure 10 Gate Charge

**Package Outline Dimensions**

Please see <http://www.diodes.com/package-outlines.html> for the latest version.

**SOT23**



SOT23			
Dim	Min	Max	Typ
A	0.37	0.51	0.40
B	1.20	1.40	1.30
C	2.30	2.50	2.40
D	0.89	1.03	0.915
F	0.45	0.60	0.535
G	1.78	2.05	1.83
H	2.80	3.00	2.90
J	0.013	0.10	0.05
K	0.890	1.00	0.975
K1	0.903	1.10	1.025
L	0.45	0.61	0.55
L1	0.25	0.55	0.40
M	0.085	0.150	0.110
a	0°	8°	--
<b>All Dimensions in mm</b>			

**Suggested Pad Layout**

Please see <http://www.diodes.com/package-outlines.html> for the latest version.

**SOT23**

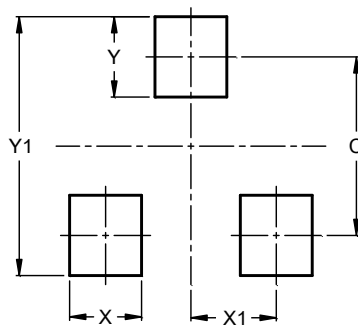

Dimensions	Value (in mm)
C	2.0
X	0.8
X1	1.35
Y	0.9
Y1	2.9

**IMPORTANT NOTICE**

DIODES INCORPORATED MAKES NO WARRANTY OF ANY KIND, EXPRESS OR IMPLIED, WITH REGARDS TO THIS DOCUMENT, INCLUDING, BUT NOT LIMITED TO, THE IMPLIED WARRANTIES OF MERCHANTABILITY AND FITNESS FOR A PARTICULAR PURPOSE (AND THEIR EQUIVALENTS UNDER THE LAWS OF ANY JURISDICTION).

Diodes Incorporated and its subsidiaries reserve the right to make modifications, enhancements, improvements, corrections or other changes without further notice to this document and any product described herein. Diodes Incorporated does not assume any liability arising out of the application or use of this document or any product described herein; neither does Diodes Incorporated convey any license under its patent or trademark rights, nor the rights of others. Any Customer or user of this document or products described herein in such applications shall assume all risks of such use and will agree to hold Diodes Incorporated and all the companies whose products are represented on Diodes Incorporated website, harmless against all damages.

Diodes Incorporated does not warrant or accept any liability whatsoever in respect of any products purchased through unauthorized sales channel. Should Customers purchase or use Diodes Incorporated products for any unintended or unauthorized application, Customers shall indemnify and hold Diodes Incorporated and its representatives harmless against all claims, damages, expenses, and attorney fees arising out of, directly or indirectly, any claim of personal injury or death associated with such unintended or unauthorized application.

Products described herein may be covered by one or more United States, international or foreign patents pending. Product names and markings noted herein may also be covered by one or more United States, international or foreign trademarks.

This document is written in English but may be translated into multiple languages for reference. Only the English version of this document is the final and determinative format released by Diodes Incorporated.

**LIFE SUPPORT**

Diodes Incorporated products are specifically not authorized for use as critical components in life support devices or systems without the express written approval of the Chief Executive Officer of Diodes Incorporated. As used herein:

A. Life support devices or systems are devices or systems which:

1. are intended to implant into the body, or
2. support or sustain life and whose failure to perform when properly used in accordance with instructions for use provided in the labeling can be reasonably expected to result in significant injury to the user.

B. A critical component is any component in a life support device or system whose failure to perform can be reasonably expected to cause the failure of the life support device or to affect its safety or effectiveness.

Customers represent that they have all necessary expertise in the safety and regulatory ramifications of their life support devices or systems, and acknowledge and agree that they are solely responsible for all legal, regulatory and safety-related requirements concerning their products and any use of Diodes Incorporated products in such safety-critical, life support devices or systems, notwithstanding any devices- or systems-related information or support that may be provided by Diodes Incorporated. Further, Customers must fully indemnify Diodes Incorporated and its representatives against any damages arising out of the use of Diodes Incorporated products in such safety-critical, life support devices or systems.

Copyright © 2017, Diodes Incorporated

[www.diodes.com](http://www.diodes.com)

## Looking for pricing, stock, or lifecycle information?

Click below to explore more details on WIN SOURCE:

 [View DMP3099LQ-13 on WIN SOURCE](#)

 [Diodes Incorporated Information](#)

## Optimize Your Supply Chain with WIN SOURCE Solutions

-  Global Sourcing Solution
-  Obsolete Management
-  Cost Control Management
-  Shortage Management
-  Alternative Solution
-  Excess Inventory Management