



**THE DATASHEET OF
C6D20065D**



C6D20065D

6th Generation 650 V, 20 A Silicon Carbide Schottky Diode

Description

With the performance advantages of a Silicon Carbide (SiC) Schottky Barrier diode, power electronics systems can expect to meet higher efficiency standards than Si-based solutions, while also reaching higher frequencies and power densities. SiC diodes can be easily paralleled to meet various application demands, without concern of thermal runaway. In combination with the reduced cooling requirements and improved thermal performance of SiC products, SiC diodes are able to provide lower overall system costs in a variety of diverse applications.

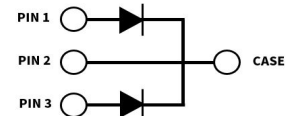

Package Types: TO-247-3
Marking: C6D20065

Features

- High-Frequency Operation
- Zero Reverse Recovery Current / Forward Recovery Voltage
- Temperature-Independent Switching Behavior
- Parallel Devices Without Thermal Runaway

Applications

- Boost Diodes in PFC or DC/DC Stages
- Free Wheeling Diodes in Inverter Stages
- Switch Mode Power Supplies
- Solar Inverters
- AC/DC Converters

Maximum Ratings ($T_c = 25^\circ\text{C}$ Unless Otherwise Specified)

* Per Leg, ** Per Device

Parameter	Symbol	Value	Unit	Test Conditions	Notes
Repetitive Peak Reverse Voltage	V_{RRM}	650	V		
Surge Peak Reverse Voltage	V_{RSM}	650			
DC Blocking Voltage	V_{DC}	650			
Continuous Forward Current (Per Leg/Per Device)	I_F	38*/76**	A	$T_c = 25^\circ\text{C}$	Fig. 3
		20*/40**		$T_c = 125^\circ\text{C}$	
		10*/20**		$T_c = 155^\circ\text{C}$	
Repetitive Peak Forward Surge Current	I_{FRM}	45*	A	$T_c = 25^\circ\text{C}, t_p = 10\text{ ms, Half Sine Wave}$	
		27*		$T_c = 110^\circ\text{C}, t_p = 10\text{ ms, Half Sine Wave}$	
Non-Repetitive Forward Surge Current	I_{FSM}	86*	A	$T_c = 25^\circ\text{C}, t_p = 10\text{ ms, Half Sine Wave}$	Fig. 8
		75*		$T_c = 110^\circ\text{C}, t_p = 10\text{ ms, Half Sine Wave}$	
Non-Repetitive Peak Forward Surge Current	$I_{F,Max}$	1250*	A	$T_c = 25^\circ\text{C}, t_p = 10\text{ }\mu\text{s, Pulse}$	
		1100*		$T_c = 110^\circ\text{C}, t_p = 10\text{ }\mu\text{s, Pulse}$	
Power Dissipation	P_{tot}	116*	W	$T_c = 25^\circ\text{C}$	Fig. 4
		50*		$T_c = 110^\circ\text{C}$	

Electrical Characteristics

Parameter	Symbol	Typ.	Max.	Unit	Test Conditions	Notes
Forward Voltage	V_F	1.27*	1.5*	V	$I_F = 10\text{ A}, T_j = 25\text{ }^\circ\text{C}$	Fig. 1
		1.37*	1.6*		$I_F = 10\text{ A}, T_j = 175\text{ }^\circ\text{C}$	
Reverse Current	I_R	2*	50*	μA	$V_R = 650\text{ V}, T_j = 25\text{ }^\circ\text{C}$	Fig. 2
		12*	200*		$V_R = 650\text{ V}, T_j = 175\text{ }^\circ\text{C}$	
Total Capacitive Charge	Q_C	35*		nC	$V_R = 400\text{ V}, T_j = 25\text{ }^\circ\text{C}$ $I_F = 10\text{ A}, di/dt = 500\text{ A}/\mu\text{s}$	Fig. 5
Total Capacitance	C	611*		pF	$V_R = 0\text{ V}, T_j = 25\text{ }^\circ\text{C}, f = 1\text{ MHz}$	Fig. 6
		67*			$V_R = 200\text{ V}, T_j = 25\text{ }^\circ\text{C}, f = 1\text{ MHz}$	
		53*			$V_R = 400\text{ V}, T_j = 25\text{ }^\circ\text{C}, f = 1\text{ MHz}$	
Capacitance Stored Energy	E_C	5.2*		μJ	$V_R = 400\text{ V}$	Fig. 7

Notes:

SiC Schottky Diodes are majority carrier devices, so there is no reverse recovery charge.

Thermal & Mechanical Characteristics

Parameter	Symbol	Value	Unit	Notes
Thermal Resistance, Junction to Case (Typical)	$R_{\theta, JC(TYP)}$	1.3* 0.64**	$^\circ\text{C} / \text{W}$	
Junction Temperature	T_j	-55 to +175	$^\circ\text{C}$	
Case & Storage Temperature	T_c	-55 to +175		
TO-247 Mounting Torque	-	1	Nm	M3 Screw
		8.8	lbf-in	6-32 Screw

* Per Leg, ** Per Device

Typical Performance

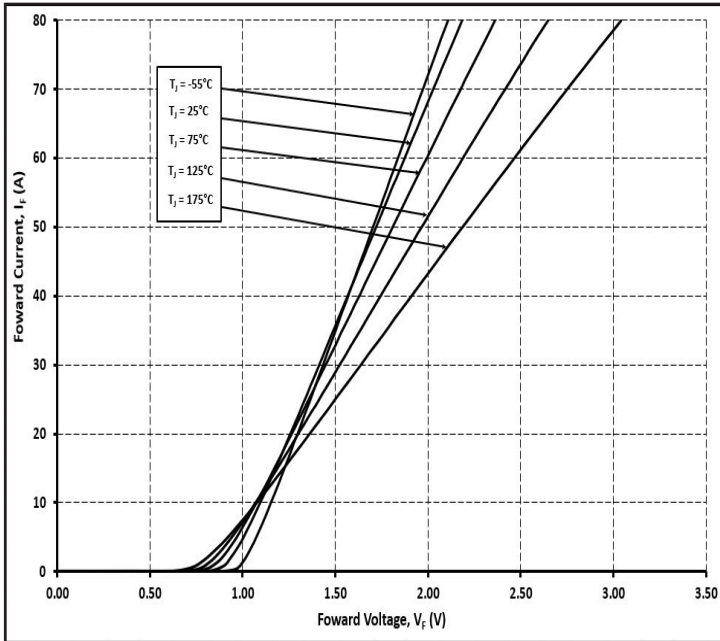

Figure 1
Forward Characteristics

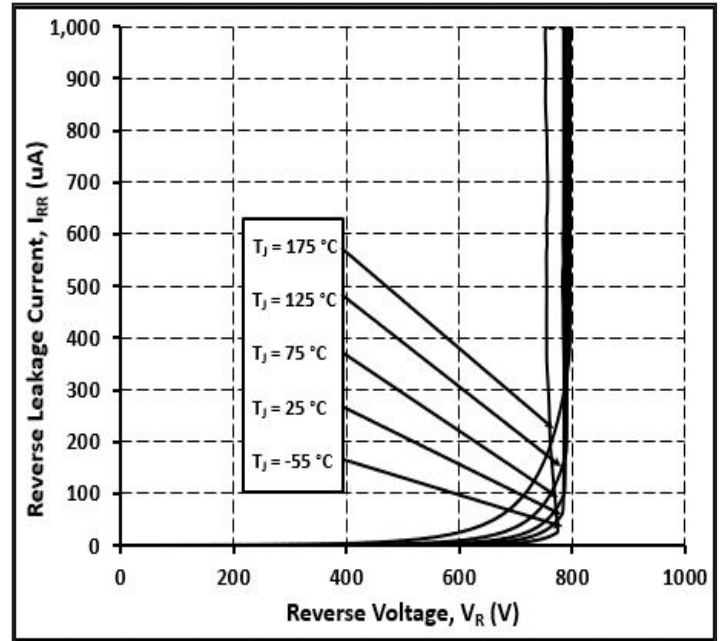

Figure 2
Reverse Characteristics

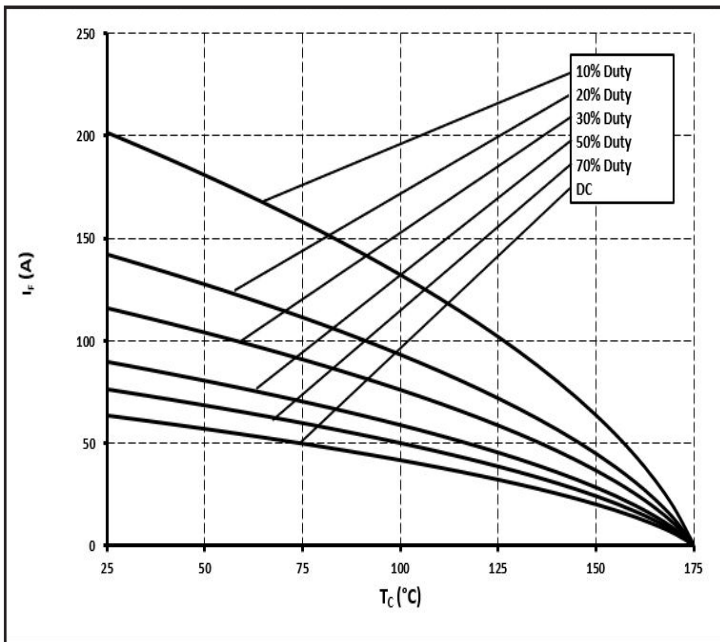

Figure 3
Current Derating

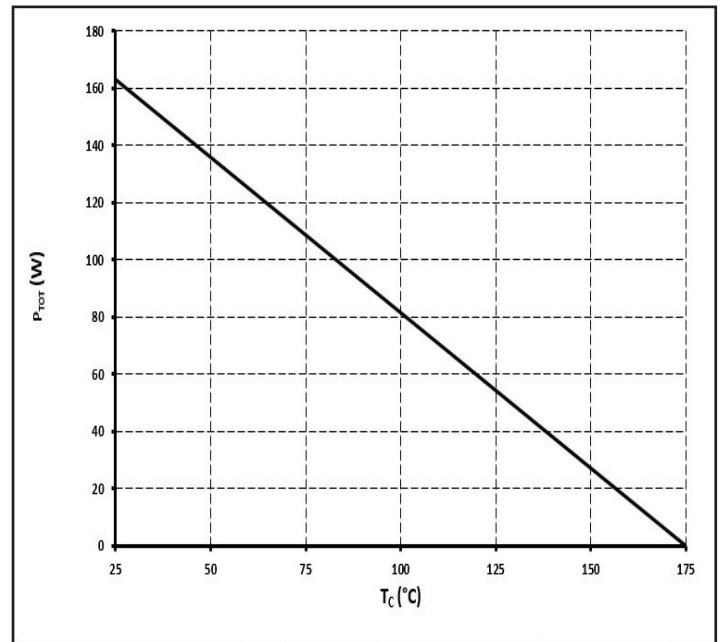

Figure 4
Power Derating



Typical Performance

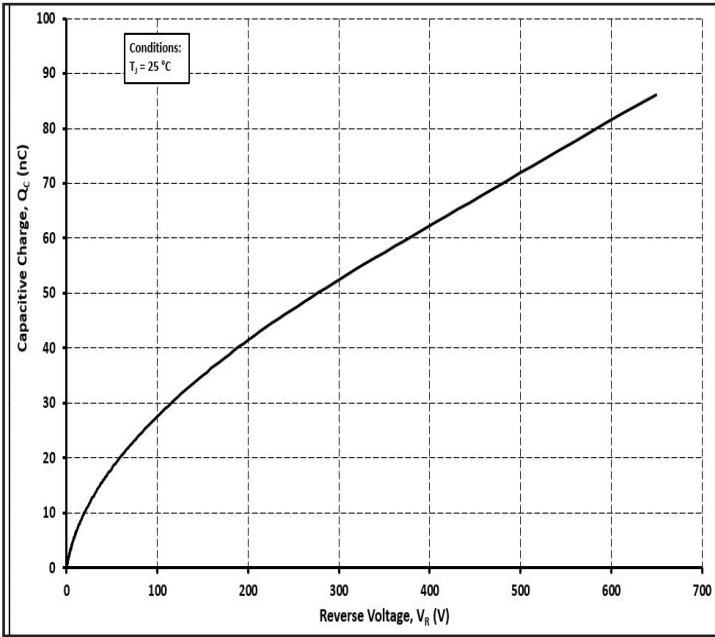

Figure 5

Total Capacitance Charge vs. Reverse Voltage

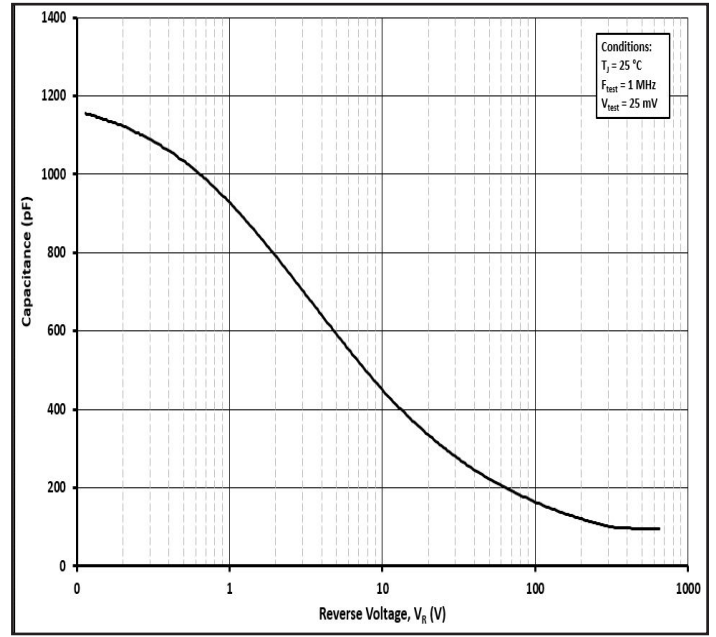

Figure 6

Capacitance vs. Reverse Voltage

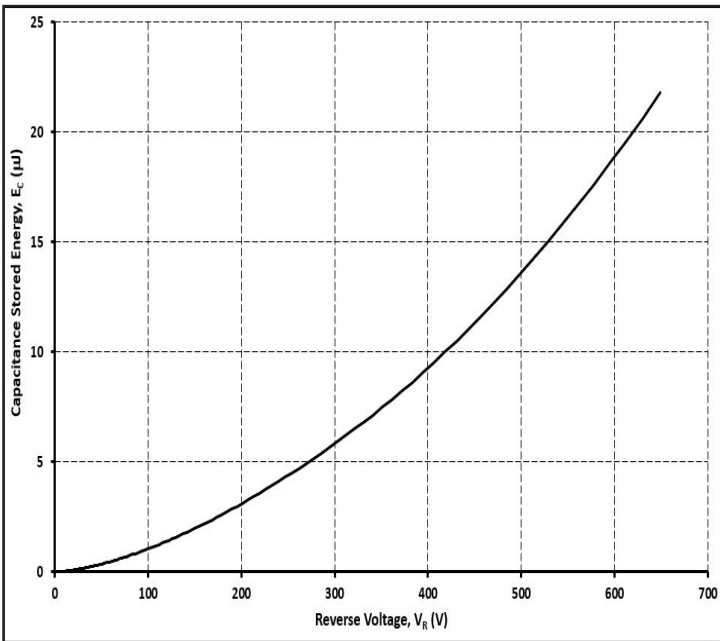

Figure 7

Capacitance Stored Energy

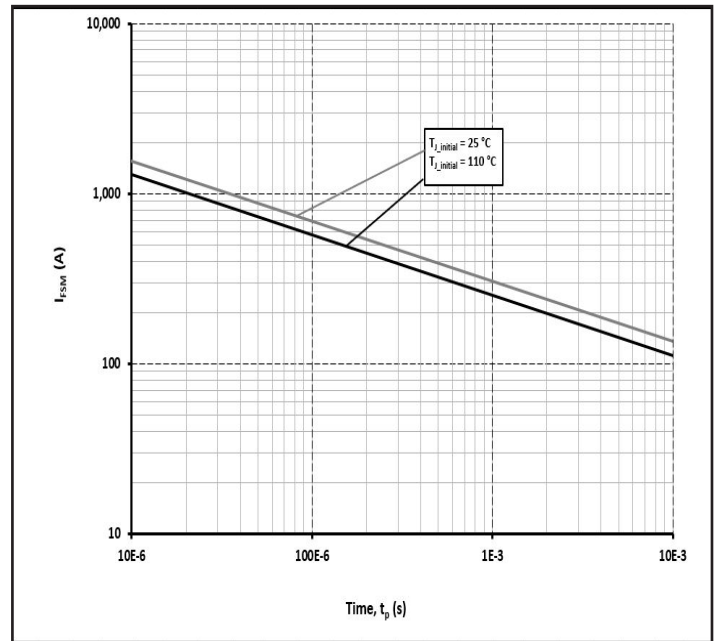

Figure 8

Non-Repetitive Peak Forward Surge Current vs. Pulse Duration

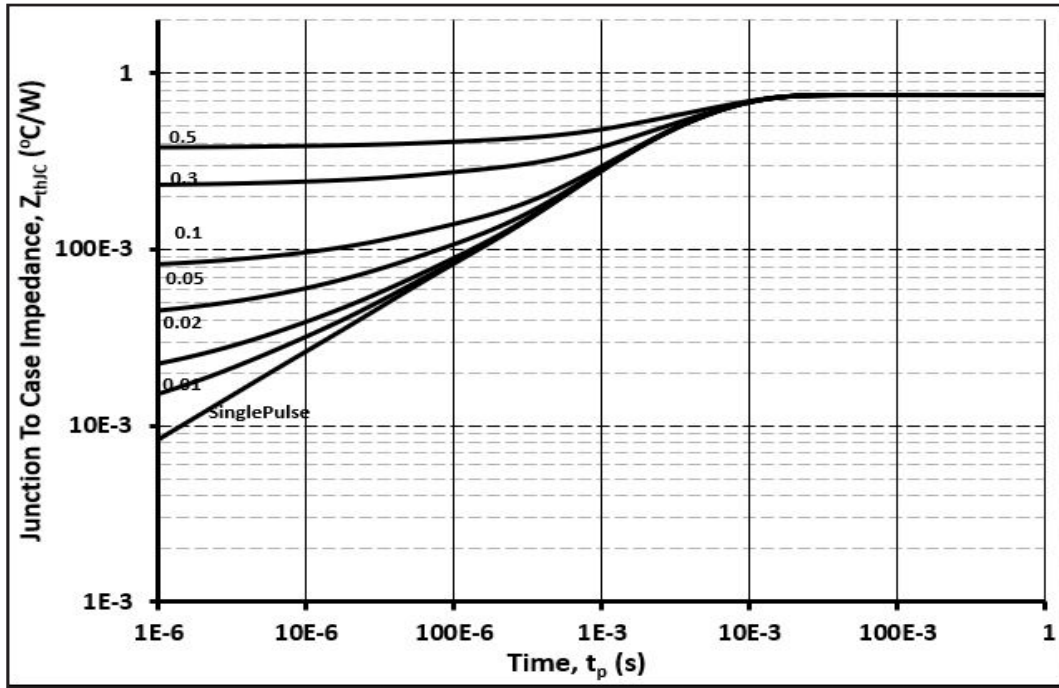
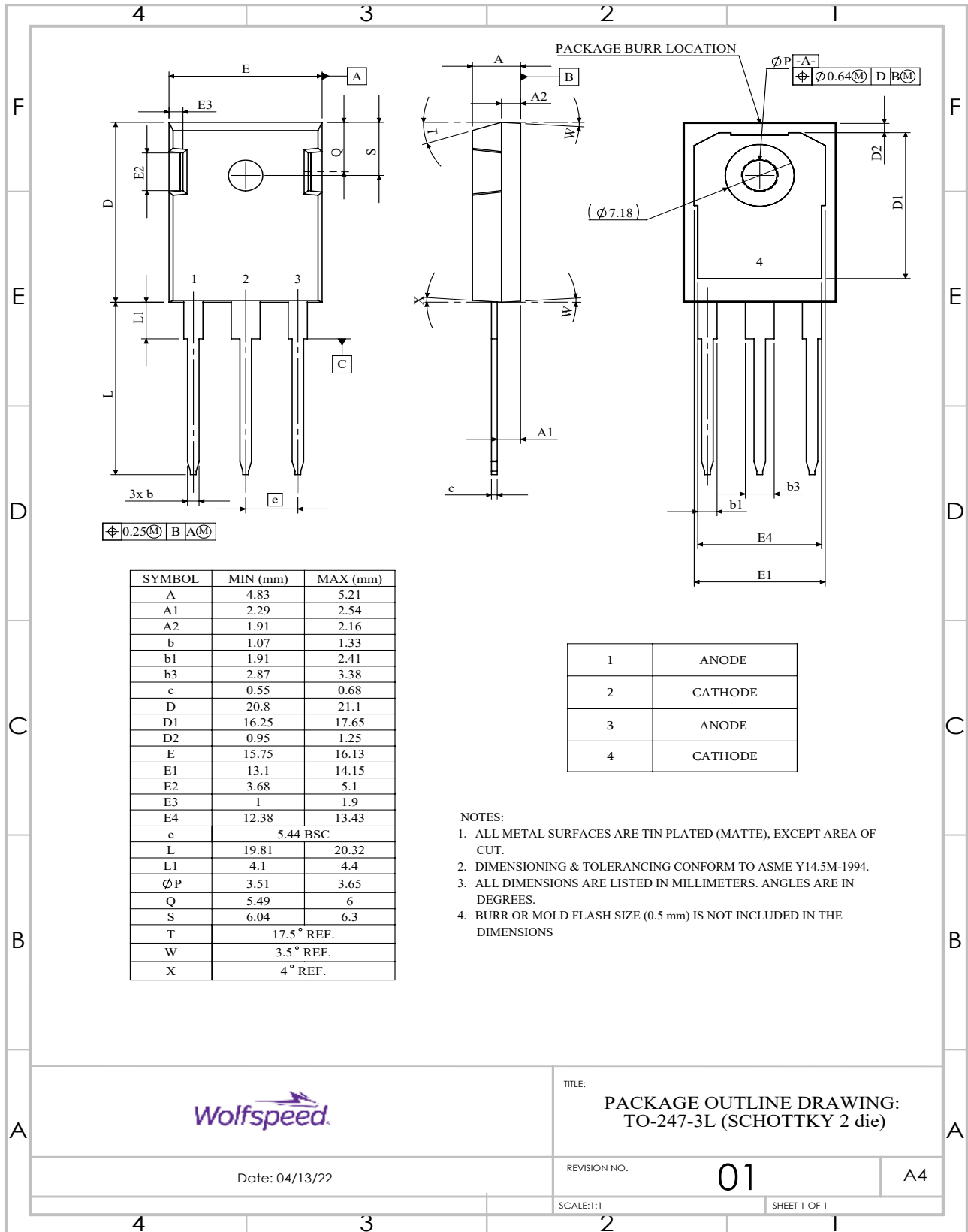

Figure 9
Transient Thermal Impedance

Package Dimensions & Pin-Out

Package: TO-247-3



TITLE: PACKAGE OUTLINE DRAWING:
TO-247-3L (SCHOTTKY 2 die)

Date: 04/13/22

REVISION NO.

01

A4

SCALE:1:1

SHEET 1 OF 1

Recommended Solder Pad Layout

Primary dimensions shown in mm.

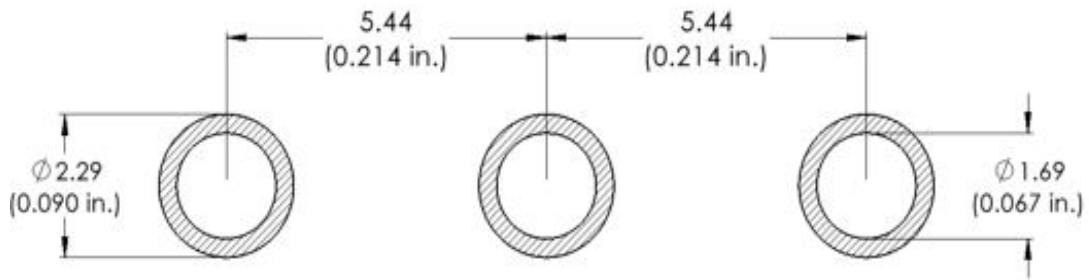

Product Ordering Information

Order Number	Packing Type
C6D20065D	Tube

REACH, RoHS, and Halogen-Free compliance documentation available for this product.



Revision History

Document Version	Date of Release	Description of Changes
2	October- 2020	Initial Release
3	November-2023	Update Branding, POD, Package Image, Solder pad layout

Notes & Disclaimer

This document and the information contained herein are subject to change without notice. Any such change shall be evidenced by the publication of an updated version of this document by Wolfspeed. No communication from any employee or agent of Wolfspeed or any third party shall effect an amendment or modification of this document. No responsibility is assumed by Wolfspeed for any infringement of patents or other rights of third parties which may result from use of the information contained herein. No license is granted by implication or otherwise under any patent or patent rights of Wolfspeed.

Notwithstanding any application-specific information, guidance, assistance, or support that Wolfspeed may provide, the buyer of this product is solely responsible for determining the suitability of this product for the buyer's purposes, including without limitation for use in the applications identified in the next bullet point, and for the compliance of the buyers' products, including those that incorporate this product, with all applicable legal, regulatory, and safety-related requirements.

This product has not been designed or tested for use in, and is not intended for use in, applications in which failure of the product would reasonably be expected to cause death, personal injury, or property damage, including but not limited to equipment implanted into the human body, life-support machines, cardiac defibrillators, and similar emergency medical equipment, aircraft navigation, communication, and control systems, aircraft power and propulsion systems, air traffic control systems, and equipment used in the planning, construction, maintenance, or operation of nuclear facilities.

RoHS Compliance

The levels of RoHS restricted materials in this product are below the maximum concentration values (also referred to as the threshold limits) permitted for such substances, or are used in an exempted application, in accordance with EU Directive 2011/65/EC (RoHS2), as implemented January 2, 2013. RoHS Declarations for this product can be obtained from your Wolfspeed representative or from the Product Documentation sections of www.wolfspeed.com.

REACH Compliance



REACH substances of high concern (SVHCs) information is available for this product. Since the European Chemical Agency (ECHA) has published notice of their intent to frequently revise the SVHC listing for the foreseeable future, please contact your Wolfspeed representative to ensure you get the most up-to-date REACH SVHC Declaration. REACH banned substance information (REACH Article 67) is also available upon request.

Contact info:

4600 Silicon Drive
Durham, NC 27703 USA
Tel: +1.919.313.5300
www.wolfspeed.com/power

Looking for pricing, stock, or lifecycle information?

Click below to explore more details on WIN SOURCE:

-  [View C6D20065D on WIN SOURCE](#)
-  [Wolfson Microelectronics plc Information](#)

Optimize Your Supply Chain with WIN SOURCE Solutions

-  Global Sourcing Solution
-  Obsolete Management
-  Cost Control Management
-  Shortage Management
-  Alternative Solution
-  Excess Inventory Management