

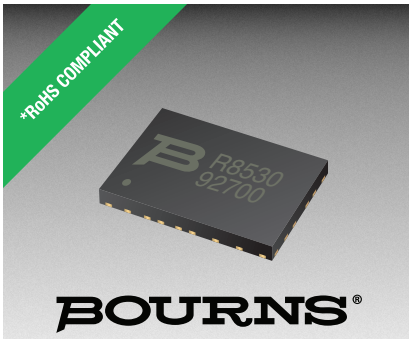

**THE DATASHEET OF  
TBU-RS085-300-WH**





## Features

- Dual channel protector for RS-485 interfaces
- Aids compliance to IEC 61000-4-2 (ESD), IEC 61000-4-4 (EFT) and IEC 61000-4-5 (Surge) standards
- Fast protection response time (1  $\mu$ s)
- RoHS compliant\*

## Additional Information

Click these links for more information:



[PRODUCT SELECTOR](#) [TECHNICAL LIBRARY](#) [INVENTORY](#) [SAMPLES](#) [CONTACT](#)

**BOURNS®**

## TBU-RSxxx-300-WH - TBU® High-Speed Protector

### General Information

Bourns® Model TBU-RSxxx-300-WH Series is an integrated dual channel Transient Blocking Unit (TBU) overcurrent device and TVS overvoltage protector for the RS-485 communications interface. When coupled with an overvoltage protector like the Bourns® GDT [Model 2036-23-SM-RPLF](#) or [2030-42T-SM-RPLF](#) or TISP® Thyristor Surge Protector Model [TISP4350J3BJR-S](#) or [TISP4350H3BJR-S](#), the integrated solution aids compliance to IEC 61000-4-2 (ESD), IEC 61000-4-4 (EFT) and IEC 61000-4-5 (Surge) standards (see Application section). Apart from a reduction in the number of components used, there is also a savings of 52 % in board space when compared to a discrete solution. Check out the latest [RS-485 Evaluation Board Design Note](#) for more information on RS-485 application integration.

The Model TBU-RSxxx-300-WH Series is available in a DFN package and meets industry standards such as RoHS and Pb-free solder reflow profiles.

### Functional Block Diagram

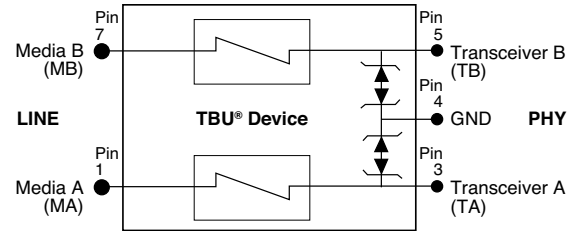

### Absolute Maximum Ratings (@ T<sub>A</sub> = 25 °C Unless Otherwise Noted)

Symbol	Parameter	Part Number	Value	Unit
V <sub>imp</sub>	+/- MA to TA or +/- MB to TB; Peak impulse voltage withstand with duration less than 10 ms	TBU-RS055-300-WH TBU-RS085-300-WH	550 850	V
V <sub>rms</sub>	+/- MA to TA or +/- MB to TB with GND floating; Continuous A.C. RMS voltage	TBU-RS055-300-WH TBU-RS085-300-WH	250 425	V
T <sub>op</sub>	Operating temperature range		-55 to +125	°C
T <sub>amax</sub>	Maximum ambient temperature		+125	°C
ESD	ESD protection per IEC 61000-4-2 - Contact discharge		±2	kV
V <sub>WM</sub>	Maximum working voltage (Line to PHY or reverse)		12 or -7	V

### Electrical Characteristics (@ T<sub>A</sub> = 25 °C Unless Otherwise Noted)

Symbol	Pin Configuration	Description	Part Number	Min.	Typ.	Max.	Unit
I <sub>trigger</sub>	Line to PHY or Reverse	Current required for the device to go from operating state to protected state		300	450	600	mA
V <sub>reset</sub>		Voltage below which the triggered TBU® device will transition to normal operating state		12	16	20	V
I <sub>Q</sub>		Current through the triggered TBU® device with 50 Vdc voltage			0.5		mA
R <sub>device</sub>		On resistance of the TBU® device	TBU-RS055-300-WH TBU-RS085-300-WH	6 15	10 21.5	14 26	Ω
t <sub>block</sub>		Time for the device to go from normal operating state to protected state			1		μs
V <sub>BR</sub>	PHY T <sub>A/B</sub> to GND or Reverse	Minimum breakdown voltage @ 1 mA		13.3 -7.5			V
I <sub>D</sub>		Leakage current @ V <sub>WM</sub>				1 20	μA
V <sub>c</sub>		Maximum clamping voltage @ 1 A				19 -11	V
V <sub>c</sub>		Maximum clamping voltage @ 5 A (8/20 pulse)				20 -12	V
V <sub>c</sub>		Maximum clamping voltage @ 17 A (8/20 pulse)				26 -14	V
C <sub>D</sub>		Typical Junction Capacitance, V <sub>OSC</sub> = 30 mV, V <sub>bias</sub> = 0 V, Osc. Frequency = 1 MHz			95		



**WARNING Cancer and Reproductive Harm**  
[www.P65Warnings.ca.gov](http://www.P65Warnings.ca.gov)

\*RoHS Directive 2015/863, Mar 31, 2015 and Annex. Specifications are subject to change without notice. Users should verify actual device performance in their specific applications. The products described herein and this document are subject to specific legal disclaimers as set forth on the last page of this document, and at [www.bourns.com/docs/legal/disclaimer.pdf](http://www.bourns.com/docs/legal/disclaimer.pdf).

## Applications

- RS-485 interface surge protection
- AISG (Antenna Interface Standards Group) modem protection

## TBU-RSxxx-300-WH Series - TBU® High-Speed Protector

**BOURNS®**

### Device Description

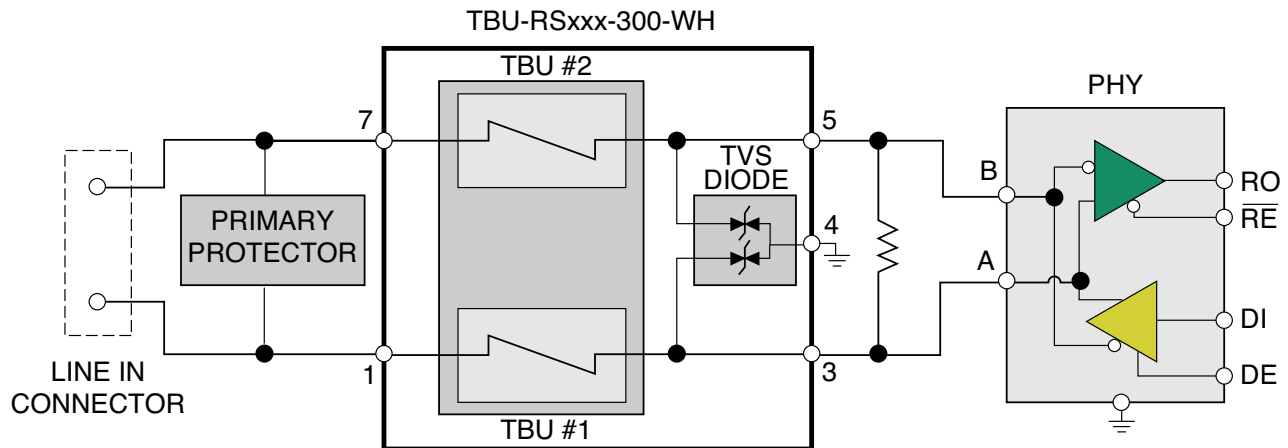

RS-485 interfaces are popular in industrial and communication applications due to their high immunity to noise. However, RS-485 interface PHYs are subject to damage by threats such as inductive transients, environmental, and lightning surges commonly found in industrial and communication installations. These threats must be taken into consideration in the design stage of the RS-485 link.

Bourns® TBU-RSxxx-300 is a highly integrated and fast RS-485 interface protector that can be used with external overvoltage devices like a GDT or thyristor to deliver IEC 61000-4-5 Class 4 protection. Check out the latest [RS-485 Evaluation Board Design Note](#) for more information on RS-485 application integration.

As shown in the above figure, the device integrates two TBU® HSPs ([click here for more information on TBU® HSPs](#)) and a pair of TVS diodes to provide a total RS-485 interface protection solution in a small footprint.

### Device Operation

In normal operation, the TBU-RSxxx-300 device's TBU® HSP exhibits low impedance and the TVS Diode exhibits high impedance which has a minimal impact on circuit operation. When a surge is detected at the RS-485 interface and the surge voltage is above the breakdown voltage ( $V_{BR}$ ) of the TVS Diode, the device's TVS diode will break down, protecting the RS-485 PHY interface by providing a low impedance path to ground. As the surge current increases above the TBU® HSP's trigger current level ( $I_{trigger}$ ), the TBU® HSP will turn off immediately, thereby blocking the surge energy in less than 1  $\mu$ s (typical). During the remainder of the surge, the TBU-RSxxx-300 device remains in the protected blocking state, consuming low quiescent current ( $I_Q$ , 0.5 mA).

The device will start its reset process at the end of a surge event; the TBU® HSP will begin the reset process when the voltage across the device drops below the  $V_{reset}$  level and will complete the reset process when the signal line returns to its normal operating range.

Specifications are subject to change without notice.

Users should verify actual device performance in their specific applications.

The products described herein and this document are subject to specific legal disclaimers as set forth on the last page of this document, and at [www.bourns.com/docs/legal/disclaimer.pdf](http://www.bourns.com/docs/legal/disclaimer.pdf).

Device Operation (Continued)

**Protection Against Lightning Surges**

To protect against surge levels of 500 V and above (see table below), the TBU-RSxxx-300 will require an external OVP device, also referred to here as “Primary Protector”. The table below outlines how the primary protector, GDT or Thyristor, when used with the TBU-RSxxx-300 device will afford protection of the RS-485 interface device to lightning waveform surges up to 4 kV.

**Primary Protectors for TBU-RSxxx-300-WH Series - Passing Combinations**

Generator Impedance	Standard	IEC 61000-4-5				
	Class	0	1	2	3	4
	Peak Test	25 V	500 V	1 kV	2 kV	4 kV
Req. = 42 Ω		TBU-RS055-300-WH	TBU-RS055-300-WH	TBU-RS055-300-WH	TBU-RS055-300-WH	TBU-RS085-300-WH
	Primary Protector	None	None	<a href="#">TISP4350H3BJR-S</a>	<a href="#">TISP4350H3BJR-S</a>	<a href="#">TISP4350J3BJR-S</a>
Req. = 12 Ω		TBU-RS055-300-WH	TBU-RS055-300-WH	TBU-RS055-300-WH	TBU-RS055-300-WH	TBU-RS085-300-WH
	Primary Protector	None	<a href="#">TISP4350H3BJR-S</a>	<a href="#">TISP4350H3BJR-S</a>	<a href="#">TISP4350H3BJR-S</a>	<a href="#">TISP4350J3BJR-S</a>
Req. = 2 Ω		TBU-RS055-300-WH	TBU-RS055-300-WH	TBU-RS055-300-WH	TBU-RS085-300-WH	TBU-RS085-300-WH
	Primary Protector	None	<a href="#">TISP4350H3BJR-S</a>	<a href="#">TISP4350J3BJR-S</a>	<a href="#">2036-23-SM-RPLF/ 2030-42T-SM-RPLF</a>	<a href="#">2036-23-SM-RPLF/ 2030-42T-SM-RPLF</a>

When selecting the Integrated RS-485 interface protector and primary protection components, it is important to be aware of the maximum surge current available. The TISP4350H3BJR can endure 300 A peak and the TISP4350J3BJR can endure 800 A in an 8/20 μs surge. A 1 kV surge can provide 500 A into a 2 ohm load, so the 800 A TISP® device is required. At 4 kV, high voltage and current combine to require the 800 A TISP® device and the 850 V Model TBU-RS085-300. If low impedance exposure to lightning surges is anticipated, the GDT with the 850 V Model TBU-RS085-300 provides the best combination. The GDT takes the current and the 850 V TBU-RS device withstands the GDT let-through voltage.

Specifications are subject to change without notice.

Users should verify actual device performance in their specific applications.

The products described herein and this document are subject to specific legal disclaimers as set forth on the last page of this document, and at [www.bourns.com/docs/legal/disclaimer.pdf](http://www.bourns.com/docs/legal/disclaimer.pdf).

Performance Graphs

Typical V-I Characteristics

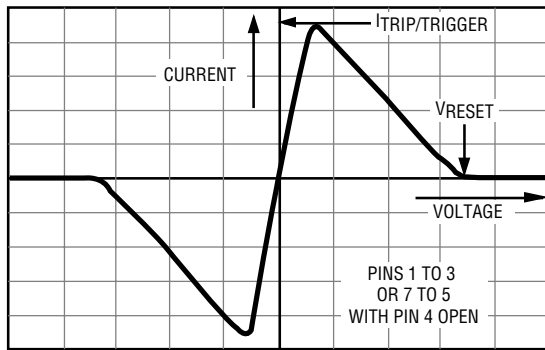

Typical Normalized  $I_{trigger}$  vs. Temperature

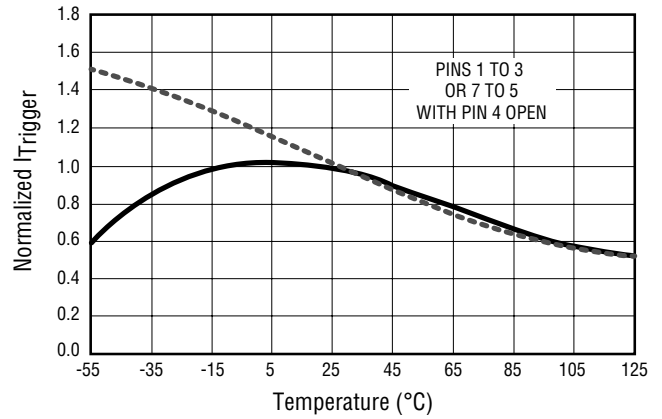

Typical Normalized Resistance vs. Temperature

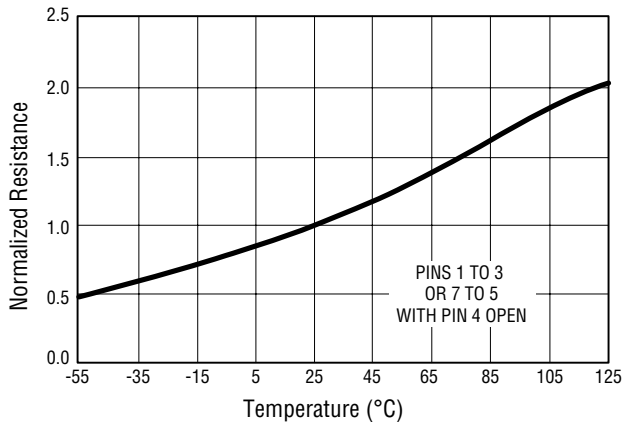

Typical 8/20  $\mu$ s Pulse Waveform

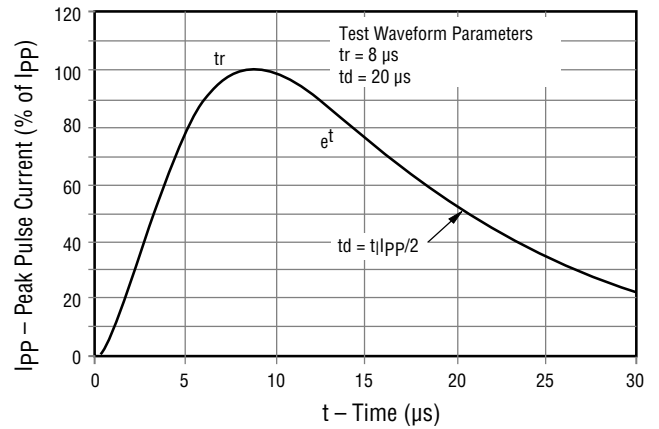

Typical V-I Curve for the Diode

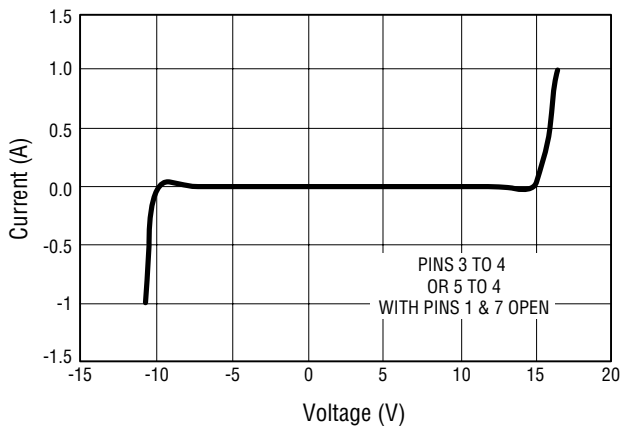

Specifications are subject to change without notice. Users should verify actual device performance in their specific applications. The products described herein and this document are subject to specific legal disclaimers as set forth on the last page of this document, and at [www.bourns.com/docs/legal/disclaimer.pdf](http://www.bourns.com/docs/legal/disclaimer.pdf).

**Product Dimensions**

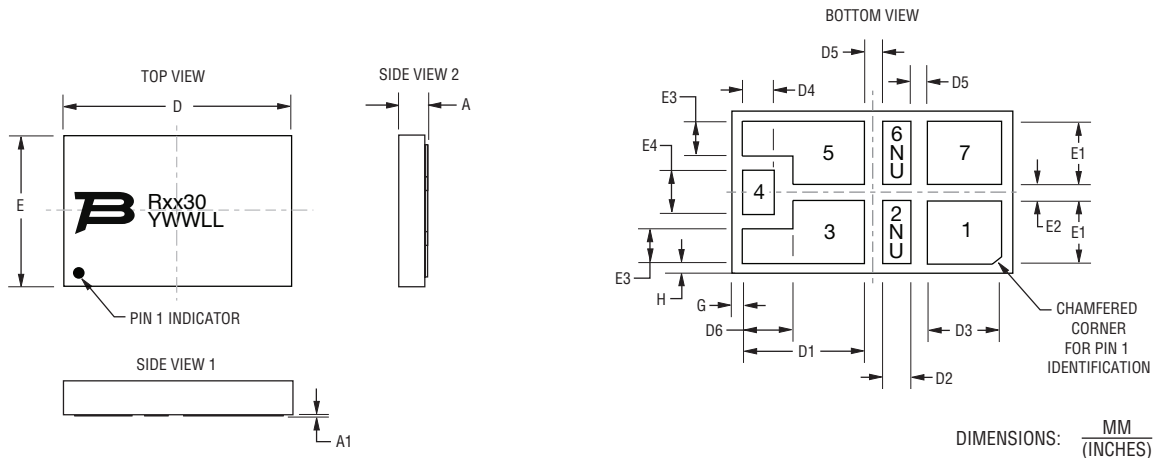

Dim.	Min.	Nom.	Max.
A	0.80 (.031)	0.90 (.035)	1.00 (.039)
A1	0.00 (.000)	—	0.50 (.002)
D	8.00 (.315) BSC		
D1	3.45 (.136)	3.50 (.138)	3.55 (.140)
D2	0.75 (.030)	0.80 (.031)	0.85 (.033)
D3	2.05 (.081)	2.10 (.083)	2.15 (.085)
D4	0.85 (.033)	0.90 (.035)	0.95 (.037)
D5	0.45 (.018)	0.50 (.020)	0.55 (.022)
D6	1.35 (.053)	1.40 (.055)	1.45 (.057)
E	5.50 (.217) BSC		
E1	2.15 (.085)	2.20 (.087)	2.25 (.089)
E2	0.45 (.018)	0.50 (.020)	0.55 (.022)
E3	1.15 (.045)	1.20 (.047)	1.25 (.049)
E4	1.45 (.057)	1.50 (.059)	1.55 (.061)
H	0.20 (.008)	0.30 (.012)	0.35 (.014)
G	0.20 (.008)	0.30 (.012)	0.35 (.018)

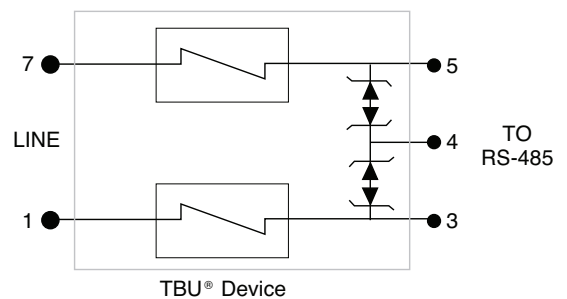

Pad #	Pin Out
1	Line 1 In
2	Not Used
3	Line 1 Out
4	Ground
5	Line 2 Out
6	Not Used
7	Line 2 In

**NOTES:**

- Pin 1 Indicator is laser marked; radius and location within the Pin 1 terminal.  
Pin 1 dot size: 0.500 ± 0.125 mm / (.020 ± .005 in.).
- Coplanarity on exposed pads shall not exceed 0.08 mm / (.003 in.).
- Warpage shall not exceed 0.10 mm / (.004 in.) on all surfaces.
- Exposed tie bars at package side are not plated.

Specifications are subject to change without notice.

Users should verify actual device performance in their specific applications.

The products described herein and this document are subject to specific legal disclaimers as set forth on the last page of this document, and at [www.bourns.com/docs/legal/disclaimer.pdf](http://www.bourns.com/docs/legal/disclaimer.pdf).

**Recommended Pad Layout**

TBU® High-Speed Protectors have a 100 % matte-tin termination finish. For improved thermal dissipation, the recommended layout uses PCB copper areas which extend beyond the exposed solder pad. The exposed solder pads should be defined by a solder mask which matches the pad layout of the TBU® device in size and spacing. It is recommended that they should be the same dimension as the TBU® pads but if smaller solder pads are used, they should be centered on the TBU® package terminal pads and not more than 0.10-0.12 mm (0.004-0.005 in.) smaller in overall width or length. Solder pad areas should not be larger than the TBU® pad sizes to ensure adequate clearance is maintained. The recommended stencil thickness is 0.10-0.12 mm (0.004-0.005 in.) with a stencil opening size 0.025 mm (0.0010 in.) less than the solder pad size. Extended copper areas beyond the solder pad significantly improve the junction to ambient thermal resistance, resulting in operation at lower junction temperatures with a corresponding benefit of reliability.

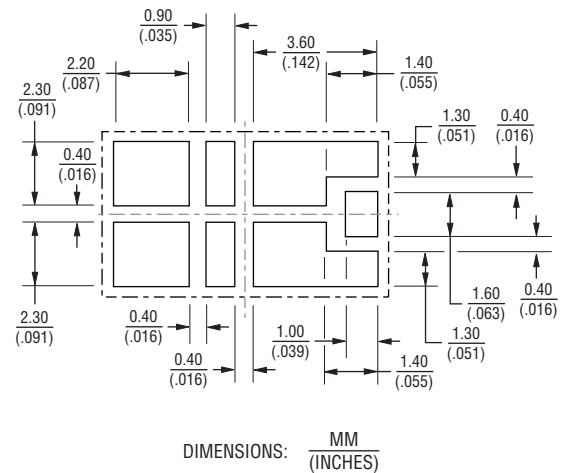

All pads should soldered to the PCB, including pads marked as NU but no electrical connection should be made to these pads. Care should be taken to assure no resistive path exists between the NU pins to any other point to avoid unexpected performance issues.

For minimum parasitic capacitance, it is recommended that signal, ground or power signals are not routed beneath any pad.

**Reflow Profile**

Profile Feature	Pb-Free Assembly
Average Ramp-Up Rate ( $T_{smax}$ to $T_p$ )	3 °C/sec. max.
Preheat	
- Temperature Min. ( $T_{smin}$ )	150 °C
- Temperature Max. ( $T_{smax}$ )	200 °C
- Time $t_s$ ( $t_{smin}$ to $t_{smax}$ )	60-180 sec.
Time maintained above:	
- Temperature ( $T_L$ )	217 °C
- Time ( $t_L$ )	60-150 sec.
Peak/Classification Temperature ( $T_p$ )	260 °C
Time within 5 °C of Actual Peak Temp. ( $t_p$ )	20-40 sec.
Ramp-Down Rate	6 °C/sec. max.
Time 25 °C to Peak Temperature $t_{25C}$ to $T_p$	8 min. max.

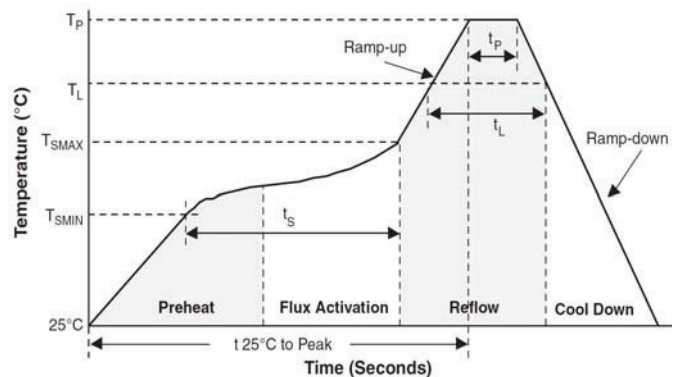

Specifications are subject to change without notice.

Users should verify actual device performance in their specific applications.

The products described herein and this document are subject to specific legal disclaimers as set forth on the last page of this document, and at [www.bourns.com/docs/legal/disclaimer.pdf](http://www.bourns.com/docs/legal/disclaimer.pdf).

# TBU-RSxxx-300-WH Series - TBU® High-Speed Protector



## How to Order

**TBU - RS 085 - 300 - WH**

TBU® Product \_\_\_\_\_  
 Series \_\_\_\_\_  
 RS = Dual Unidirectional Model for RS-485 Interfaces  
 Impulse Voltage Rating \_\_\_\_\_  
 055 = 550 V  
 085 = 850 V  
 Trigger Current \_\_\_\_\_  
 300 = 300 mA  
 Hold to Trip Ratio Suffix \_\_\_\_\_  
 W = Hold to Trip Ratio  
 Package Suffix \_\_\_\_\_  
 H = DFN Package

## Environmental Specifications

Moisture Sensitivity Level ..... 1  
 ESD Classification (HBM)..... 2

## Typical Part Marking

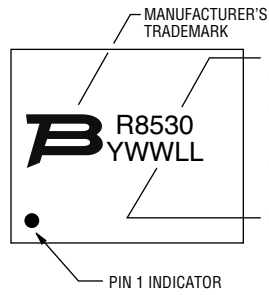

- 5 DIGIT PRODUCT CODE:
- 1ST ALPHA CHARACTER INDICATES PRODUCT FAMILY:  
R = TBU-RS SERIES
  - 2ND & 3RD DIGITS INDICATE IMPULSE VOLTAGE:  
55 = 550 V  
85 = 850 V
  - 4TH & 5TH DIGITS INDICATE TRIGGER CURRENT:  
30 = 300 mA
- MANUFACTURING DATE CODE:
- 1ST DIGIT INDICATES THE YEAR.
  - 2ND & 3RD DIGITS INDICATE THE WEEK NUMBER.
  - 4TH & 5TH DIGITS INDICATE LOT CODE.

# TBU-RSxxx-300-WH Series - TBU® High-Speed Protector



## Packaging Specifications

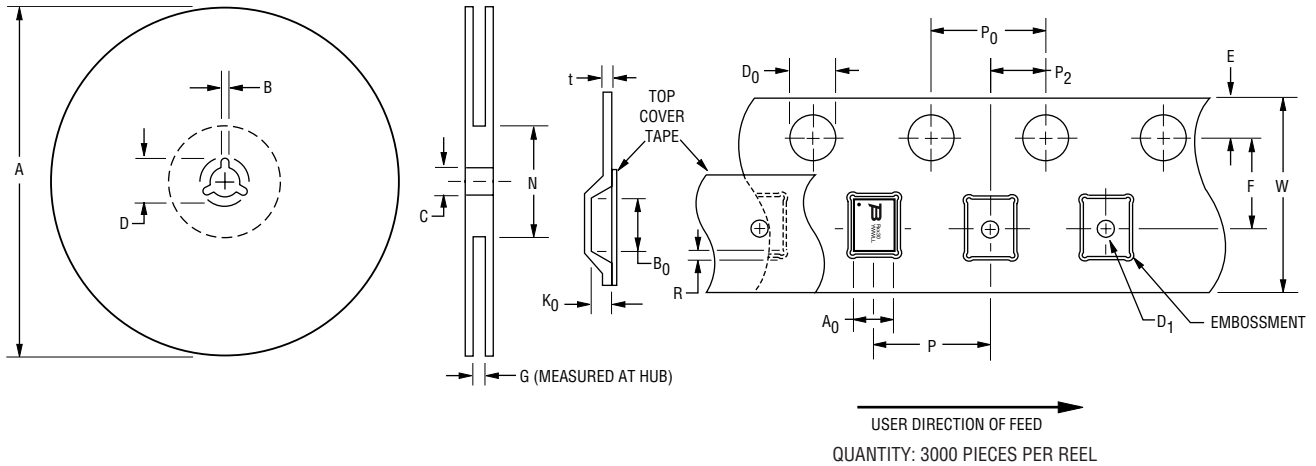

A		B		C		D		G	N
Min.	Max.	Min.	Max.	Min.	Max.	Min.	Max.	Ref.	Ref.
$\frac{328.5}{(12.93)}$	$\frac{331}{(13.05)}$	$\frac{2.0}{(0.079)}$	$\frac{2.4}{(0.094)}$	$\frac{12.8}{(0.504)}$	$\frac{13.5}{(.531)}$	$\frac{17.0}{(0.669)}$	$\frac{17.4}{(0.690)}$	$\frac{16.5}{(0.650)}$	$\frac{100 \pm 1.5}{(3.94 \pm 0.059)}$

A0		B0		D0		D1		E		F	
Min.	Max.	Min.	Max.	Min.	Max.	Min.	Max.	Min.	Max.	Min.	Max.
$\frac{5.75}{(0.224)}$	$\frac{5.95}{(0.234)}$	$\frac{6.75}{(0.266)}$	$\frac{6.95}{(0.274)}$	$\frac{1.5}{(0.059)}$	$\frac{1.6}{(0.063)}$	$\frac{1.5}{(0.059)}$	—	$\frac{1.65}{(0.065)}$	$\frac{1.85}{(0.073)}$	$\frac{7.4}{(0.291)}$	$\frac{7.6}{(0.299)}$
K0		P		P0		P2		R		t	
Min.	Max.	Min.	Max.	Min.	Max.	Min.	Max.	Min.	Max.	Min.	Max.
$\frac{1.05}{(0.041)}$	$\frac{1.25}{(0.049)}$	$\frac{7.9}{(0.311)}$	$\frac{8.1}{(0.319)}$	$\frac{3.9}{(0.159)}$	$\frac{4.1}{(0.161)}$	$\frac{1.9}{(0.075)}$	$\frac{2.1}{(0.083)}$	$\frac{0}{(0)}$	$\frac{0.5}{(.020)}$	$\frac{0.25}{(0.010)}$	$\frac{0.35}{(0.014)}$

W	
Min.	Max.
$\frac{15.7}{(0.618)}$	$\frac{16.3}{(0.642)}$

DIMENSIONS:  $\frac{\text{MM}}{\text{(INCHES)}}$



Asia-Pacific: Tel: +886-2 2562-4117 • Email: asiacus@bourns.com

EMEA: Tel: +36 88 885 877 • Email: eurocus@bourns.com

The Americas: Tel: +1-951 781-5500 • Email: americus@bourns.com

www.bourns.com

REV. 12/19/22

“TBU” is a registered trademark of Bourns, Inc. in the United States and other countries.

Specifications are subject to change without notice.

Users should verify actual device performance in their specific applications.

The products described herein and this document are subject to specific legal disclaimers as set forth on the last page of this document, and at [www.bourns.com/docs/legal/disclaimer.pdf](http://www.bourns.com/docs/legal/disclaimer.pdf).

This legal disclaimer applies to purchasers and users of Bourns® products manufactured by or on behalf of Bourns, Inc. and its affiliates (collectively, "Bourns").

Unless otherwise expressly indicated in writing, Bourns® products and data sheets relating thereto are subject to change without notice. Users should check for and obtain the latest relevant information and verify that such information is current and complete before placing orders for Bourns® products.

The characteristics and parameters of a Bourns® product set forth in its data sheet are based on laboratory conditions, and statements regarding the suitability of products for certain types of applications are based on Bourns' knowledge of typical requirements in generic applications. The characteristics and parameters of a Bourns® product in a user application may vary from the data sheet characteristics and parameters due to (i) the combination of the Bourns® product with other components in the user's application, or (ii) the environment of the user application itself. The characteristics and parameters of a Bourns® product also can and do vary in different applications and actual performance may vary over time. Users should always verify the actual performance of the Bourns® product in their specific devices and applications, and make their own independent judgments regarding the amount of additional test margin to design into their device or application to compensate for differences between laboratory and real world conditions.

Unless Bourns has explicitly designated an individual Bourns® product as meeting the requirements of a particular industry standard (e.g., ISO/TS 16949) or a particular qualification (e.g., UL listed or recognized), Bourns is not responsible for any failure of an individual Bourns® product to meet the requirements of such industry standard or particular qualification. Users of Bourns® products are responsible for ensuring compliance with safety-related requirements and standards applicable to their devices or applications.

Bourns® products are not recommended, authorized or intended for use in nuclear, lifesaving, life-critical or life-sustaining applications, nor in any other applications where failure or malfunction may result in personal injury, death, or severe property or environmental damage. Unless expressly and specifically approved in writing by two authorized Bourns representatives on a case-by-case basis, use of any Bourns® products in such unauthorized applications might not be safe and thus is at the user's sole risk. Life-critical applications include devices identified by the U.S. Food and Drug Administration as Class III devices and generally equivalent classifications outside of the United States.

Bourns expressly identifies those Bourns® standard products that are suitable for use in automotive applications on such products' data sheets in the section entitled "Applications." Unless expressly and specifically approved in writing by two authorized Bourns representatives on a case-by-case basis, use of any other Bourns® standard products in an automotive application might not be safe and thus is not recommended, authorized or intended and is at the user's sole risk. If Bourns expressly identifies a sub-category of automotive application in the data sheet for its standard products (such as infotainment or lighting), such identification means that Bourns has reviewed its standard product and has determined that if such Bourns® standard product is considered for potential use in automotive applications, it should only be used in such sub-category of automotive applications. Any reference to Bourns® standard product in the data sheet as compliant with the AEC-Q standard or "automotive grade" does not by itself mean that Bourns has approved such product for use in an automotive application.

Bourns® standard products are not tested to comply with United States Federal Aviation Administration standards generally or any other generally equivalent governmental organization standard applicable to products designed or manufactured for use in aircraft or space applications. Bourns expressly identifies Bourns® standard products that are suitable for use in aircraft or space applications on such products' data sheets in the section entitled "Applications." Unless expressly and specifically approved in writing by two authorized Bourns representatives on a case-by-case basis, use of any other Bourns® standard product in an aircraft or space application might not be safe and thus is not recommended, authorized or intended and is at the user's sole risk.

The use and level of testing applicable to Bourns® custom products shall be negotiated on a case-by-case basis by Bourns and the user for which such Bourns® custom products are specially designed. Absent a written agreement between Bourns and the user regarding the use and level of such testing, the above provisions applicable to Bourns® standard products shall also apply to such Bourns® custom products.

Users shall not sell, transfer, export or re-export any Bourns® products or technology for use in activities which involve the design, development, production, use or stockpiling of nuclear, chemical or biological weapons or missiles, nor shall they use Bourns® products or technology in any facility which engages in activities relating to such devices. The foregoing restrictions apply to all uses and applications that violate national or international prohibitions, including embargos or international regulations. Further, Bourns® products and Bourns technology and technical data may not under any circumstance be exported or re-exported to countries subject to international sanctions or embargoes. Bourns® products may not, without prior authorization from Bourns and/or the U.S. Government, be resold, transferred, or re-exported to any party not eligible to receive U.S. commodities, software, and technical data.

To the maximum extent permitted by applicable law, Bourns disclaims (i) any and all liability for special, punitive, consequential, incidental or indirect damages or lost revenues or lost profits, and (ii) any and all implied warranties, including implied warranties of fitness for particular purpose, non-infringement and merchantability.



*For your convenience, copies of this Legal Disclaimer Notice with German, Spanish, Japanese, Traditional Chinese and Simplified Chinese bilingual versions are available at:*

*Web Page:* <http://www.bourns.com/legal/disclaimers-terms-and-policies>

*PDF:* <http://www.bourns.com/docs/Legal/disclaimer.pdf>

## Looking for pricing, stock, or lifecycle information?

Click below to explore more details on WIN SOURCE:

-  [View TBU-RS085-300-WH on WIN SOURCE](#)
-  [Bourns Inc. Information](#)

## Optimize Your Supply Chain with WIN SOURCE Solutions

-  Global Sourcing Solution
-  Obsolete Management
-  Cost Control Management
-  Shortage Management
-  Alternative Solution
-  Excess Inventory Management