



# THE DATASHEET OF 1N60G



N-沟道功率 MOS 管/ N-CHANNEL POWER MOSFET

●最大额定值 (TC=25°C)

● Absolute Maximum Ratings ( Tc=25°C ) TO-92/251T/251S/252/223

参数 PARAMETER	符号 SYMBOL	额定值 VALUE	单位 UNIT
漏-源电压 Drain-source Voltage	V <sub>DS</sub>	600	V
栅-源电压 gate-source Voltage	V <sub>GS</sub>	± 30	V
漏极电流 Continuous Drain Current TC=25°C	I <sub>D</sub>	1.0*	A
漏极电流 Continuous Drain Current TC=100°C	I <sub>D</sub>	0.6*	A
最大脉冲电流 Drain Current – Pulsed ①	I <sub>DM</sub>	4.0*	A
耗散功率 Power Dissipation (T <sub>L</sub> =25°C)	P <sub>D</sub>	TO-92	W
		TO-251T/251S/252/223	
最高结温 Junction Temperature	T <sub>J</sub>	150	°C
存储温度 Storage Temperature	T <sub>STG</sub>	-55-150	°C
单脉冲雪崩能量 Single Pulse Avalanche Energy②	E <sub>AS</sub>	14	mJ

\*漏极电流由最高结温限制

\*Drain current limited by maximum junction temperature

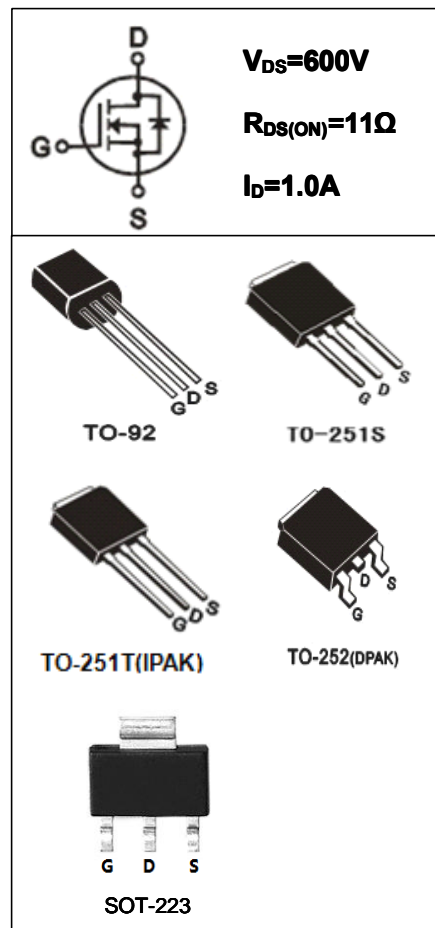

●电特性 (Tc=25°C)

● Electronic Characteristics ( Tc=25°C )

参数 PARAMETER	符号 SYMBOL	测试条件 TEST CONDITION	最小值 MIN	典型值 TYP	最大值 MAX	单位 UNIT
漏-源击穿电压 Drain-source Breakdown Voltage	BV <sub>DSS</sub>	V <sub>GS</sub> =0V, I <sub>D</sub> =250μA	600			V
击穿电压温度系数 Breakdown Voltage Temperature Coefficient	Δ BV <sub>DSS</sub> / Δ T <sub>J</sub>	I <sub>D</sub> =250uA, Referenced to 25°C		0.6		V/°C
栅极开启电压 Gate Threshold Voltage	V <sub>GS(TH)</sub>	V <sub>GS</sub> =V <sub>DS</sub> , I <sub>D</sub> =250μA	2.0		4.0	V
漏-源漏电流 Drain-source Leakage Current	I <sub>DSS</sub>	V <sub>DS</sub> =600V, V <sub>GS</sub> =0V, T <sub>J</sub> =25°C			25	μA
		V <sub>DS</sub> =480V, V <sub>GS</sub> =0V, T <sub>J</sub> =125°C			250	μA
跨导 Forward Transconductance	g <sub>fs</sub>	V <sub>DS</sub> =40V, I <sub>D</sub> =0.5A ③	0.5			S

**N-沟道功率 MOS 管/ N-CHANNEL POWER MOSFET**

参数 PARAMETER	符号 SYMBOL	测试条件 TEST CONDITION	最小值 MIN	典型值 TYP	最大值 MAX	单位 UNIT
栅极漏电流 Gate-body Leakage Current ( $V_{DS} = 0$ )	$I_{GSS}$	$V_{GS} = \pm 30V$			$\pm 100$	nA
漏-源导通电阻 Static Drain-source On Resistance	$R_{DS(ON)}$	$V_{GS} = 10V, I_D = 0.5A$ ③		8.5	11	$\Omega$
输入电容 Input Capacitance	$C_{iss}$	$V_{GS} = 0V, V_{DS} = 25V$ $F = 1.0MHz$		150		pF
输出电容 Output Capacitance	$C_{oss}$			25		
反向传输电容 Reverse transfer Capacitance	$C_{rss}$			5.4		
关断延迟 Turn -Off Delay Time	$T_d(off)$	$V_{DD} = 300V, I_D = 1.0A$ $R_G = 25\Omega$ ③		13		ns
栅极电荷 Total Gate Charge	$Q_g$	$I_D = 1.0A, V_{DS} = 480V$ $V_{GS} = 10V$ ③		4.8		nC
栅源电荷 Gate-to-Source Charge	$Q_{gs}$			0.7		nC
栅漏电荷 Gate-to-Drain Charge	$Q_{gd}$			2.7		nC
二极管正向电流 Continuous Diode Forward Current	$I_S$				1.0	A
二极管正向压降 Diode Forward Voltage	$V_{SD}$	$T_j = 25^\circ C, I_S = 0.5A$ $V_{GS} = 0V$ ③			1.4	V
反向恢复时间 Reverse Recovery Time	$t_{rr}$	$T_j = 25^\circ C, I_f = 1.0A$ $di/dt = 100A/\mu s$ ③		190		ns
反向恢复电荷 Reverse Recovery Charge	$Q_{rr}$			0.53		$\mu C$

**●热特性**
**● Thermal Characteristics**

参数 PARAMETER	符号 SYMBOL	最大值 MAX		单位 UNIT
		TO-92	TO-251T/251S/252/223	
热阻结-环境 Thermal Resistance Junction-lead	$R_{thJL}$	41.67	4.46	$^\circ C/W$
热阻结-环境 Thermal Resistance Junction-ambient	$R_{thJA}$	140.0	110.0	$^\circ C/W$

**注释(Notes):**

- ① 脉冲宽度：以最高节温为限制  
Repetitive rating: Pulse width limited by maximum junction temperature
- ② 初始结温= $25^\circ C$ ,  $V_{DD} = 50V$ ,  $L = 30mH$ ,  $R_G = 25\Omega$ ,  $I_{AS} = 1.0A$   
Starting  $T_j = 25^\circ C$ ,  $V_{DD} = 50V$ ,  $L = 30mH$ ,  $R_G = 25\Omega$ ,  $I_{AS} = 1.0A$
- ③ 脉冲测试：脉冲宽度 $\leq 300\mu s$ ，占空比 $\leq 2\%$   
Pulse Test : Pulse width  $\leq 300\mu s$ , Duty cycle  $\leq 2\%$

N-沟道功率 MOS 管/ N-CHANNEL POWER MOSFET

● 特性曲线



图 1 输出特性曲线, Tc=25°C

Fig1 Typical Output Characteristics, Tc=25°C

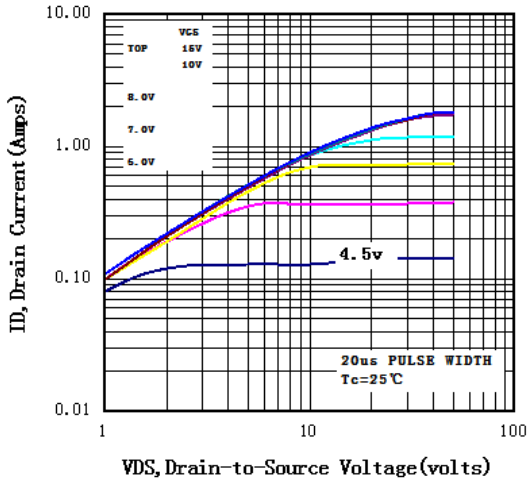

图 2 输出特性曲线, Tc=150°C

Fig2 Typical Output Characteristics, Tc=150°C

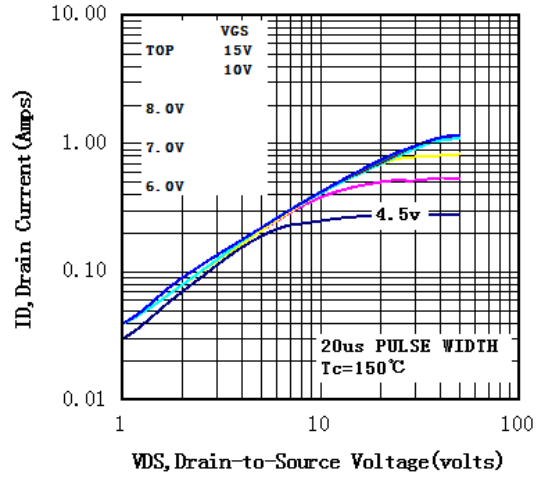

图 3 归一化导通电阻与温度曲线

Fig3 Normalized On-Resistance Vs. Temperature

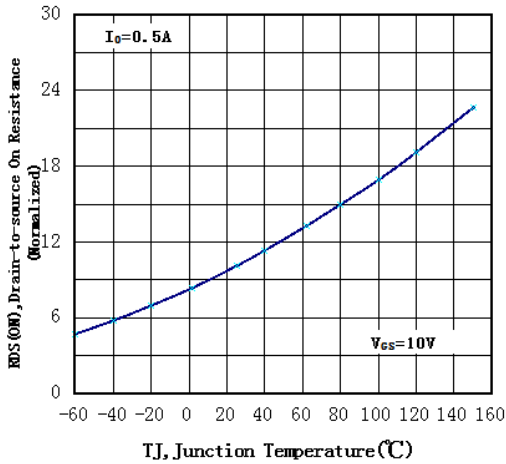

图 4 二极管正向电压曲线

Fig4 Typical Source-Drain Diode Forward Voltage

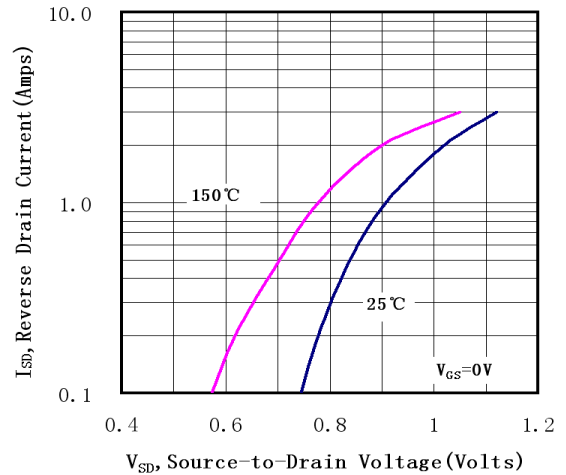

图 5 最大漏极电流与壳温曲线

Fig5 Maximum Drain Current Vs. Case Temperature

**TO-92 封装机械尺寸**  
**TO-92 MECHANICAL DATA**

单位:毫米/UNIT: mm

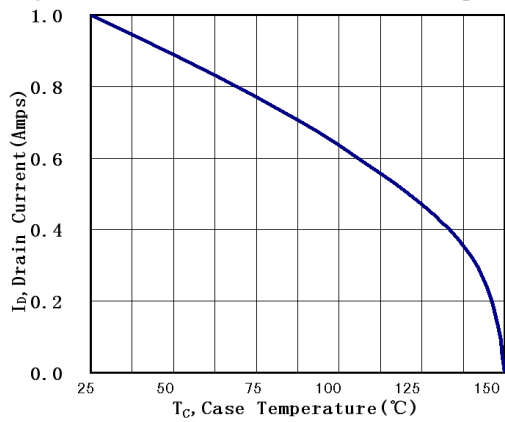
符号/SYMBOL	最小值/min	典型值/nom	最大值/max
A	4.30		5.30
b	0.30		0.55
c	0.30		0.50
φD	4.30		5.20
D			
d	1.00		1.70
E	3.20		4.20
e		2.54	
e1		1.27	
L	12.70		15.00
L1	1.50		2.00

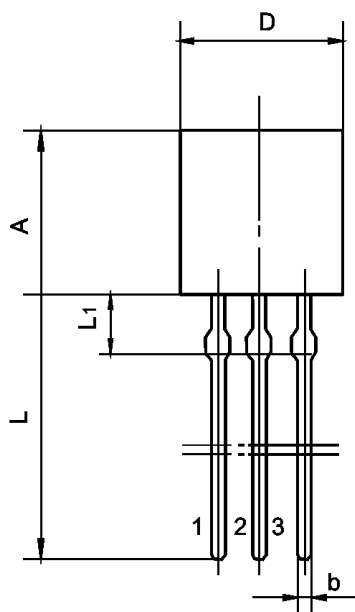
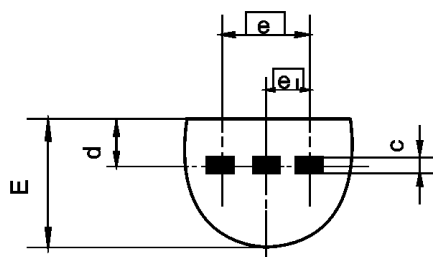

**TO-251T 封装机械尺寸**  
**TO-251T (IPAK) MECHANICAL DATA**

单位:毫米/UNIT: mm

符号/SYMBOL	最小值/min	典型值/nom	最大值/max
A	2.10		2.50
A <sub>1</sub>	0.95		1.30
B	0.80		1.25
b	0.50		0.80
b <sub>1</sub>	0.70		0.80
c	0.45		0.70
c <sub>1</sub>	0.45		0.70
D	6.35		6.80
D <sub>1</sub>	5.10		5.50
E	5.30		6.30
e	2.25	2.30	2.35
L	7.00		9.20
H	0.35		0.45
W <sub>1</sub>	0.30		0.50
W <sub>2</sub>	0.20		0.40

[S/L]

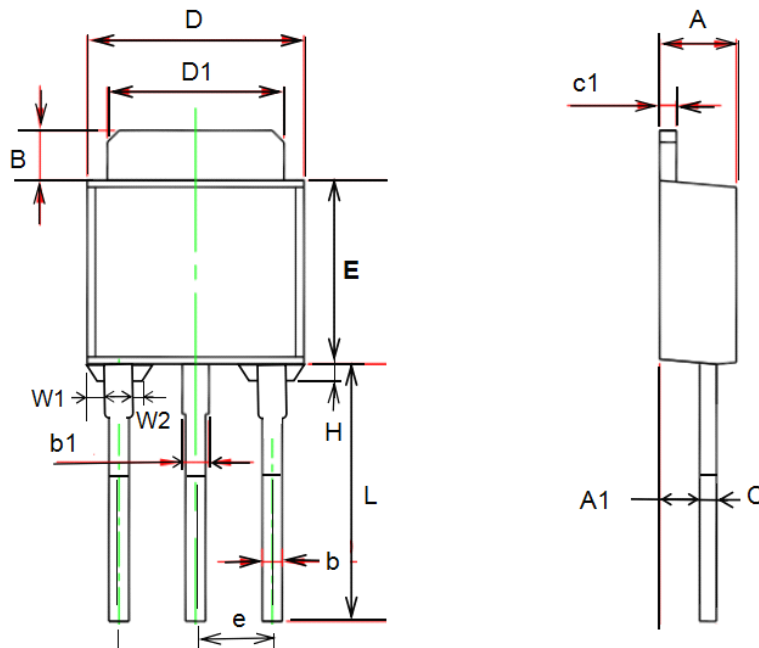

**TO-251S 封装机械尺寸**  
**TO-251S (IPAK) MECHANICAL DATA**

单位:毫米/UNIT: mm

符号/SYMBOL	最小值/min	典型值/nom	最大值/max
A	2.20		2.40
b	0.60		0.85
C	0.45	0.50	0.60
D	6.50		6.70
D1	5.10		5.50
E	5.9		6.20
e	2.18	2.29	2.38
L	11.00		12.40
L1	4.8		5.3
L2	3.5		4.2

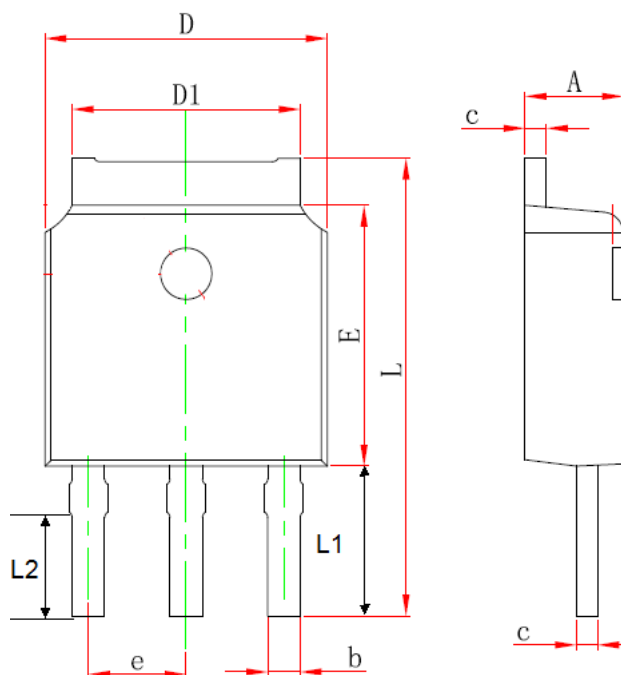

**TO-252 封装机械尺寸**  
**TO-252 MECHANICAL DATA**

单位:毫米/UNIT: mm

符号 SYMBOL	最小值 min	最大值 max	符号 SYMBOL	最小值 min	最大值 max
A	2.10	2.50	B	0.85	1.25
b	0.50	0.80	b1	0.50	0.90
b2	0.45	0.70	C	0.45	0.70
D	6.30	6.75	D1	5.10	5.50
E	5.30	6.30	e1	2.25	2.35
L1	9.20	10.60	e2	4.45	4.75
L2	0.90	1.75	L3	0.60	1.10
K	0.00	0.23			

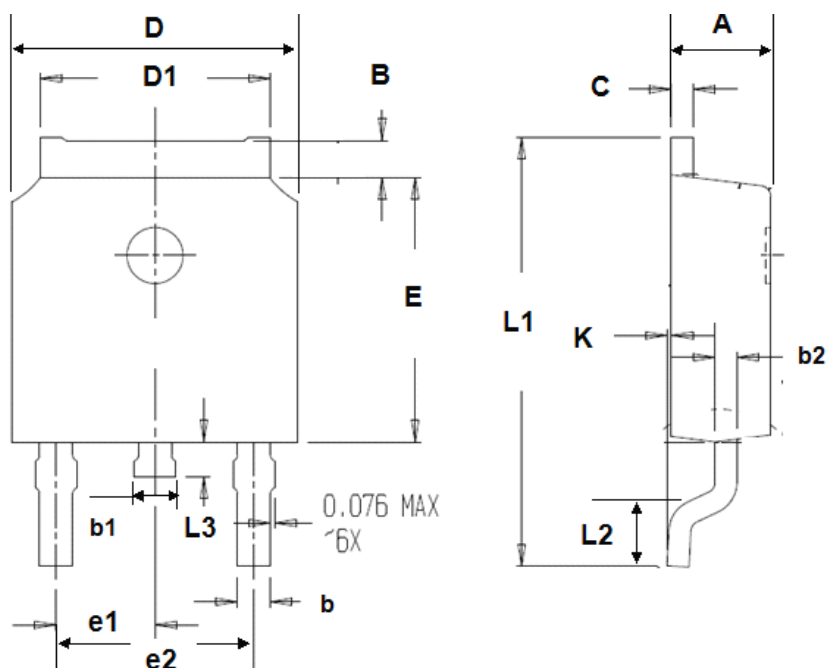

TO-252 编带规格尺寸  
TO-252 TAPE AND REEL DATA

单位:毫米/UNIT: mm

符号 SYMBOL	最小值 min	最大值 max	符号 SYMBOL	最小值 min	最大值 max
W	16.0-0.3	16.0+0.3	F	7.5-0.1	7.5+0.1
P0	4.0-0.1	4.0+0.1	D	1.5-0.0	1.5+0.1
P	8.0-0.1	8.0+0.1	P1	2.0-0.1	2.0+0.1
K	2.65	2.80	D1	1.5-0.0	1.5+0.1

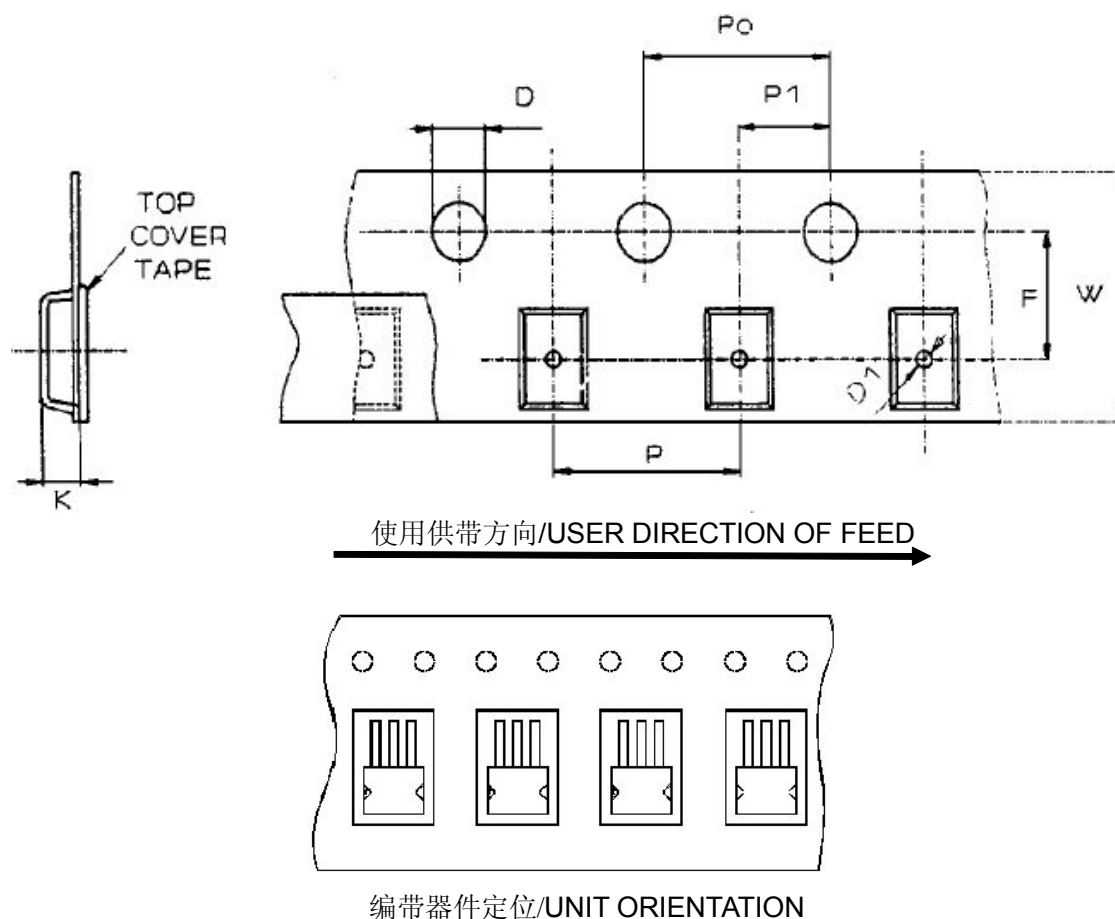

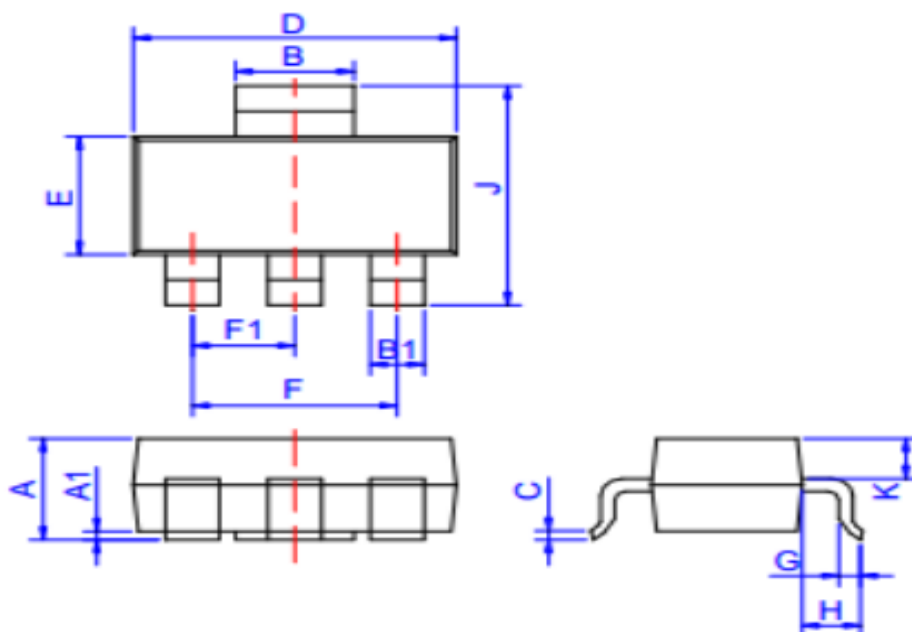

**SOT-223 封装机械尺寸**  
**SOT-223 MECHANICAL DATA**

Ref.	Dimensions					
	Millimeters			Inches		
	Min.	Typ.	Max.	Min.	Typ.	Max.
A	1.5	1.6	1.8	0.059	0.063	0.071
A1	0.01	0.06	0.10	0.001	0.002	0.004
B	2.9	3.0	3.1	0.114	0.118	0.122
B1	0.6	0.7	0.8	0.024	0.028	0.031
C	0.22	0.26	0.32	0.009	0.010	0.013
D	6.3	6.5	6.7	0.248	0.256	0.264
E	3.3	3.5	3.7	0.130	0.138	0.146
F		4.6			0.181	
F1		2.3			0.091	
G	0.7	0.9	1.1	0.028	0.035	0.043
H	1.5	1.75	2	0.059	0.069	0.079
J	6.7	7.0	7.3	0.264	0.276	0.287
K		0.9			0.035	







## Looking for pricing, stock, or lifecycle information?

Click below to explore more details on WIN SOURCE:

-  [View 1N60G on WIN SOURCE](#)
-  [NXP / Nexperia Information](#)

## Optimize Your Supply Chain with WIN SOURCE Solutions

-  Global Sourcing Solution
-  Obsolete Management
-  Cost Control Management
-  Shortage Management
-  Alternative Solution
-  Excess Inventory Management