



**THE DATASHEET OF  
DG307ACJ**



# MAXIM

## CMOS Analog Switches

DG304(A)/DG305(A)/DG306(A)/DG307(A)

### General Description

Maxim's DG304-DG307 and DG304A-DG307A CMOS dual and quad analog switches combine low power operation with fast switching times and superior DC and AC switch characteristics. On resistance is less than 50Ω and is essentially constant over the analog signal range. Device specifications are ideal for battery powered circuitry.

These switches are available in a variety of formats as outlined below in the Pin Configurations section. The switch control logic inputs are compatible with CMOS logic. Also featured are "break-before-make" switching and low charge injection.

Maxim's DG304-DG307 and DG304A-DG307A families are electrically compatible and pin compatible with the original manufacturer's devices. All devices will operate with power supplies ranging from ±5V to ±18V. Single supply operation is implemented by connecting V<sup>-</sup> to GND.

### Applications

- Portable Instruments
- Low Power Sample/Holds
- Power Supply Switching
- Programmable Gain Amplifiers
- SPDT and DPDT Functions
- Process Control and Telemetry

### Features

- ◆ Monolithic Low Power CMOS
- ◆ Latch-Up Proof Construction
- ◆ Fully Compatible 2nd Source
- ◆ Low On Resistance, <50Ω
- ◆ Fast Switching Time
- ◆ V<sup>+</sup> to V<sup>-</sup> Analog Signal Range
- ◆ Single Supply Capability

### Ordering Information

PART	TEMP RANGE	PACKAGE
DG304C/D	0°C to +70°C	Dice
DG304CJ	0°C to +70°C	14 Lead Plastic DIP
DG304CWE	0°C to +70°C	16 Lead Wide SO
DG304CK	0°C to +70°C	14 Lead CERDIP
DG304BWE	-25°C to +85°C	16 Lead Wide SO
DG304BK	-25°C to +85°C	14 Lead CERDIP
DG304BA	-25°C to +85°C	10 Lead Metal Can
DG304AK	-55°C to +125°C	14 Lead CERDIP
DG304AA	-55°C to +125°C	10 Lead Metal Can

Ordering Information continued at end of data sheet.

### Pin Configurations

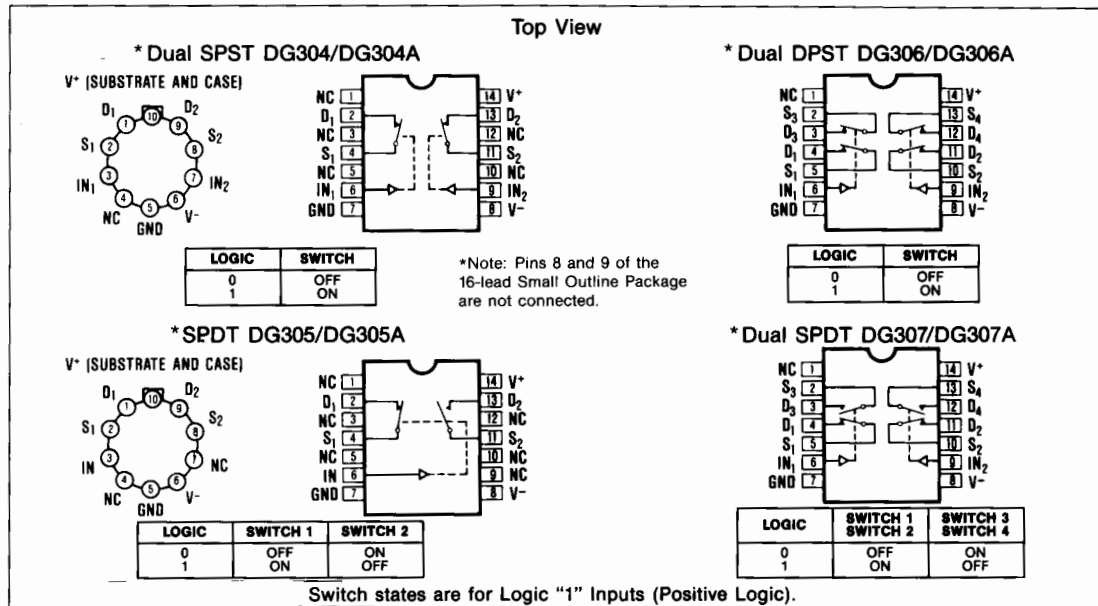

## CMOS Analog Switches

### ABSOLUTE MAXIMUM RATINGS

Voltages Referenced to V <sup>-</sup>	
V <sup>+</sup> (DG304-DG307)	36V
V <sup>+</sup> (DG304A-DG307A)	44V
GND	25V
Digital Inputs, V <sub>S</sub> , V <sub>D</sub> (Note 1)	-4V to (V <sup>+</sup> + 4V) or 30mA, whichever occurs first.
Current, Any Terminal Except S or D	30mA
Continuous Current, S or D	30mA
(Pulsed at 1msec, 10% duty cycle max)	100mA
Storage Temperature (A & B Suffix)	-65°C to 150°C
(C Suffix)	-65°C to 125°C

Operating Temperature (A Suffix)	-55°C to 125°C
(B Suffix)	-25°C to 85°C
(C Suffix)	0°C to 70°C
Lead Temperature (Soldering 10 sec.)	+300°C
Power Dissipation*	
Cerdip (K) (Derate 11mW/°C above 75°C)	825mW
Plastic DIP (J) (Derate 6.5mW/°C above 25°C)	470mW
Metal Can (A) (Derate 6mW/°C above 75°C)	450mW

\* Device mounted with all leads soldered or welded to PC board.

Stresses listed under "Absolute Maximum Ratings" may be applied (one at a time) to devices without resulting in permanent damage. These are stress ratings only, and functional operation of the device at these or any other conditions above those indicated in the operational sections of the specifications is not implied. Exposure to absolute maximum ratings conditions for extended periods may affect device reliability.

### ELECTRICAL CHARACTERISTICS (V<sup>+</sup> = +15V, V<sup>-</sup> = -15V, GND = 0V, T<sub>A</sub> = 25°C, unless otherwise indicated)

	PARAMETER	SYMBOL	TEST CONDITIONS	DG304-DG307A DG304A-DG307AA		DG304-DG307B/C DG304A-DG307AB/C		UNITS		
				MIN	TYP (Note 2)	MAX (Note 3)	MIN		TYP (Note 2)	MAX (Note 3)
SWITCH	Analog Signal Range	V <sub>ANALOG</sub>	I <sub>S</sub> = 10mA, V <sub>in</sub> = 3.5V or 11.0V	-15		15	-15	15	V	
	Drain-Source ON Resistance	r <sub>DS(on)</sub>	I <sub>S</sub> = -10mA, V <sub>D</sub> = 10V	30		50	30	50	Ω	
			I <sub>S</sub> = 10mA, V <sub>D</sub> = -10V	30		50	30	50		
	Source OFF Leakage Current	I <sub>S(off)</sub>	V <sub>in</sub> = 3.5V or V <sub>in</sub> = 11.0V	V <sub>S</sub> = 14V, V <sub>D</sub> = -14V	0.1		1	0.1	5	nA
				V <sub>S</sub> = -14V, V <sub>D</sub> = 14V	-1		-0.1	-5	-0.1	
	Drain OFF Leakage Current	I <sub>D(off)</sub>		V <sub>S</sub> = -14V, V <sub>D</sub> = 14V	0.1		1	0.1	5	
V <sub>S</sub> = 14V, V <sub>D</sub> = -14V				-1		-0.1	-5	-0.1		
Drain ON Leakage Current	I <sub>D(on)</sub>	V <sub>D</sub> = V <sub>S</sub> = 14V	0.1		1	0.1	5			
		V <sub>D</sub> = V <sub>S</sub> = -14V	-2		-0.1	-5	-0.1			
INPUT	Input Current/ Voltage High	I <sub>INH</sub>	V <sub>in</sub> = 5.0V	-1		-0.001	-1	-0.001	μA	
			V <sub>in</sub> = 15V	0.001		1	0.001	1		
	Input Current/ Voltage Low	I <sub>INL</sub>	V <sub>in</sub> = 0V	-1		-0.001	-1	-0.001		
DYNAMIC	Turn-ON Time	t <sub>on</sub>	See Switching Time Test Circuit	110		250	110	250	ns	
	Turn-OFF Time	t <sub>off</sub>		70		150	70	150		
	Break-Before-Make Interval	t <sub>on</sub> -t <sub>off</sub>	See Break-Before-Make Time Test Circuit DG305(A)/DG307(A) Only	50			50			
	Charge Injection	Q	C <sub>L</sub> = 10nF, R <sub>gen</sub> = 0Ω, V <sub>gen</sub> = 0V	12			12		pC	
	Source OFF Capacitance	C <sub>S(off)</sub>	f = 1MHz, V <sub>in</sub> = 3.5V or V <sub>in</sub> = 11.0V	V <sub>S</sub> = 0V	14			14	pF	
	Drain OFF Capacitance	C <sub>D(off)</sub>		V <sub>D</sub> = 0V	14			14		
	Channel-ON Capacitance	C <sub>D(on)</sub> + C <sub>S(on)</sub>		V <sub>S</sub> = V <sub>D</sub> = 0V	40			40		
	Input Capacitance	C <sub>in</sub>	f = 1MHz	V <sub>in</sub> = 0V	6			6		
V <sub>in</sub> = 15V				7			7			
Off Isolation (Note 4)			V <sub>in</sub> = 0V, R <sub>L</sub> = 1kΩ	62			62	dB		
Crosstalk (Channel to Channel)			V <sub>S</sub> = 1 V <sub>RMS</sub> , f = 500kHz	74			74			

(See Notes next page).

# CMOS Analog Switches

DG304(A)/DG305(A)/DG306(A)/DG307(A)

## ELECTRICAL CHARACTERISTICS (Continued)

(V<sup>+</sup> = +15V, V<sup>-</sup> = -15V, GND = 0V, T<sub>A</sub> = 25°C, unless otherwise indicated)

	PARAMETER	SYMBOL	TEST CONDITIONS	DG304-DG307A DG304A-DG307AA			DG304-DG307B/C DG304A-DG307AB/C			UNITS
				MIN (Note 2)	TYP (Note 3)	MAX	MIN (Note 2)	TYP (Note 3)	MAX	
SUPPLY	Positive Supply Current	I <sup>+</sup>	V <sub>in</sub> = 15.0V (All Inputs)	0.001		10	0.001		10	μA
	Negative Supply Current	I <sup>-</sup>		-10		-0.001	-10		-0.001	
	Positive Supply Current	I <sup>+</sup>	V <sub>in</sub> = 0V (All Inputs)	0.001		10	0.001		10	
	Negative Supply Current	I <sup>-</sup>		-10		-0.001	-10		-0.001	

## ELECTRICAL CHARACTERISTICS (Over Temperature)

(V<sup>+</sup> = +15V, GND = 0V, T<sub>A</sub> = Over Temperature Range, unless otherwise noted)

	PARAMETER	SYMBOL	TEST CONDITIONS	DG304-DG307A DG304A-DG307AA			DG304-DG307B/C DG304A-DG307AB/C			UNITS
				MIN (Note 2)	TYP (Note 3)	MAX	MIN (Note 2)	TYP (Note 3)	MAX	
SWITCH	Analog Signal Range	V <sub>ANALOG</sub>	I <sub>S</sub> = 10mA, V <sub>in</sub> = 3.5V or 11.0V	-15		15	-15		15	V
	Drain-Source ON Resistance	r <sub>DS(on)</sub>	V <sub>in</sub> = 3.5V or 11.0V	I <sub>S</sub> = -10mA, V <sub>D</sub> = 10V		75		75	Ω	
				I <sub>S</sub> = 10mA, V <sub>D</sub> = -10V		75		75		
	Source OFF Leakage Current	I <sub>S(off)</sub>	V <sub>in</sub> = 3.5V or 11.0V	V <sub>S</sub> = 14V, V <sub>D</sub> = -14V		100		100	nA	
				V <sub>S</sub> = -14V, V <sub>D</sub> = 14V	-100		-100			
	Drain OFF Leakage Current	I <sub>D(off)</sub>	V <sub>in</sub> = 3.5V or 11.0V	V <sub>S</sub> = -14V, V <sub>D</sub> = 14V		100		100		
				V <sub>S</sub> = 14V, V <sub>D</sub> = -14V	-100		-100			
Drain ON Leakage Current	I <sub>D(on)</sub>	V <sub>in</sub> = 3.5V or 11.0V	V <sub>D</sub> = V <sub>S</sub> = 14V		100		100			
			V <sub>D</sub> = V <sub>S</sub> = -14V	-200		-200				
INPUT	Input Current/Voltage High	I <sub>INH</sub>	V <sub>in</sub> = 5.0V	-1			-10	μA		
			V <sub>in</sub> = 15V			1	10			
	Input Current/Voltage Low	I <sub>INL</sub>	V <sub>in</sub> = 0V	-1			-10			
SUPPLY	Positive Supply Current	I <sup>+</sup>	V <sub>in</sub> = 15.0V (All Inputs)			100		200	μA	
	Negative Supply Current	I <sup>-</sup>		-100			-200			
	Positive Supply Current	I <sup>+</sup>	V <sub>in</sub> = 0V (All Inputs)			100		200		
	Negative Supply Current	I <sup>-</sup>		-100			-200			

**Note 1:** Signals on S<sub>x</sub>, D<sub>x</sub>, or IN<sub>x</sub> exceeding V<sup>+</sup> or V<sup>-</sup> will be clamped by internal diodes. Limit diode forward current to maximum current ratings.

**Note 2:** The algebraic convention whereby the most negative value is a minimum, and the most positive value is a maximum is used in this data sheet.

**Note 3:** Typical values are for DESIGN AID ONLY, not guaranteed nor subject to production testing.

**Note 4:** OFF isolation = 20 log  $\frac{V_S}{V_D}$ , V<sub>S</sub> = input to OFF switch, V<sub>D</sub> = Output.

# CMOS Analog Switches

## Typical Operating Characteristics

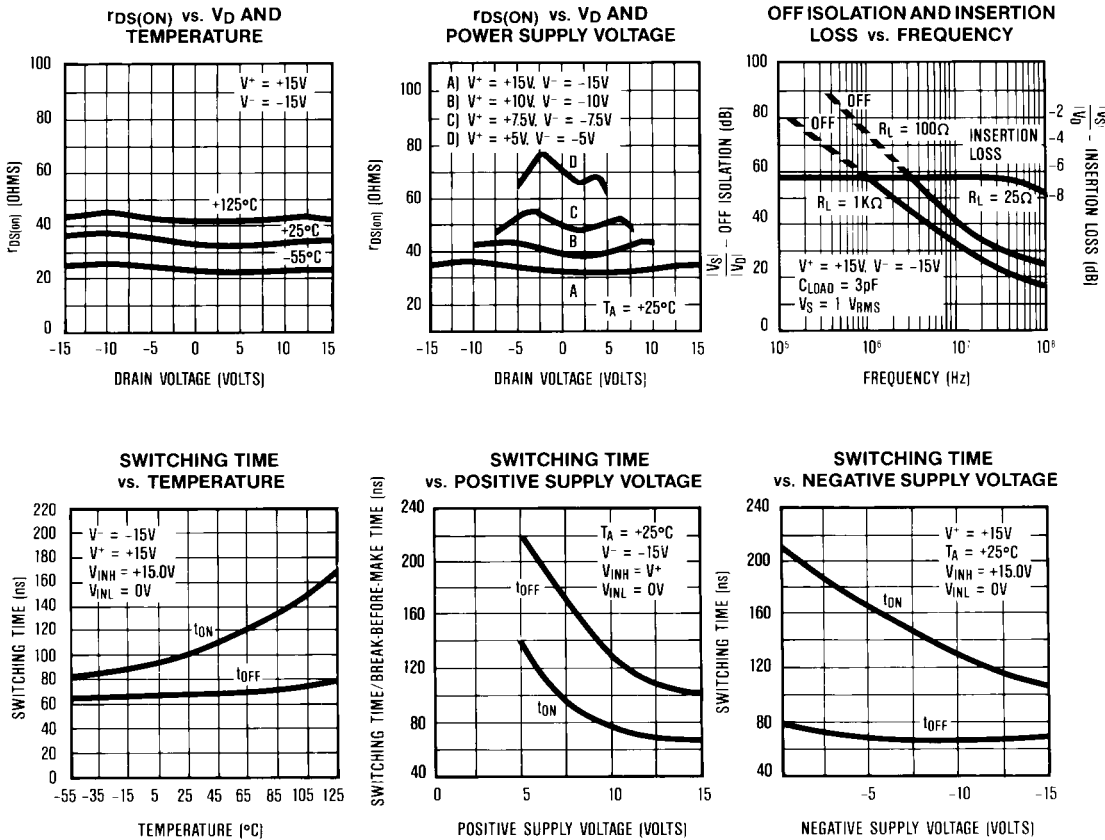

## Test Circuits

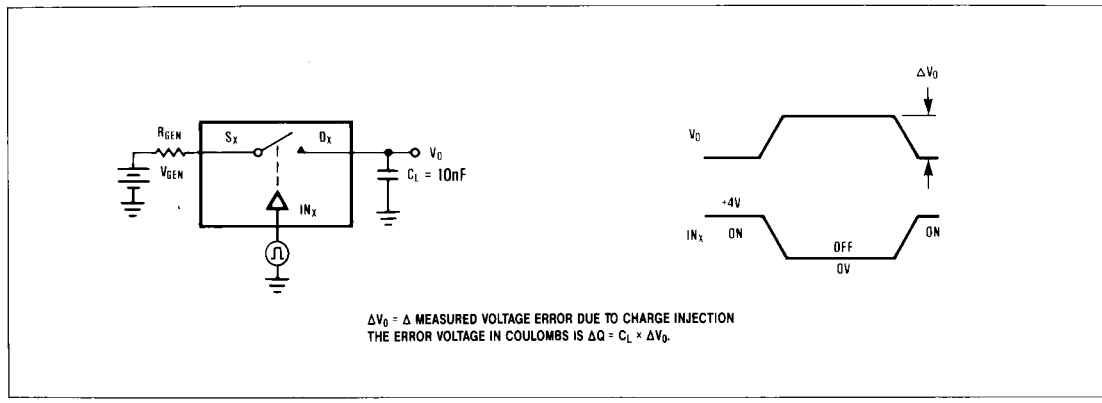

Figure 1. Charge Injection Test Circuit.

# CMOS Analog Switches

## Test Circuits (Continued)

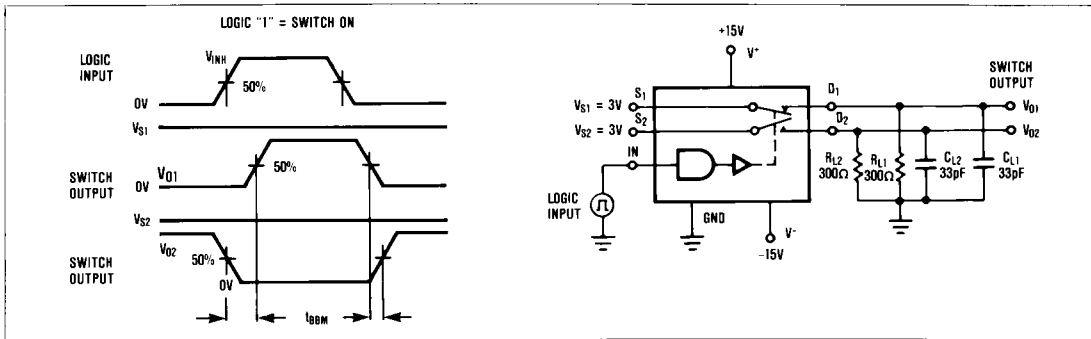

Figure 2. Break-Before-Make Time Test Circuit SPDT DG305(A), DG307(A).

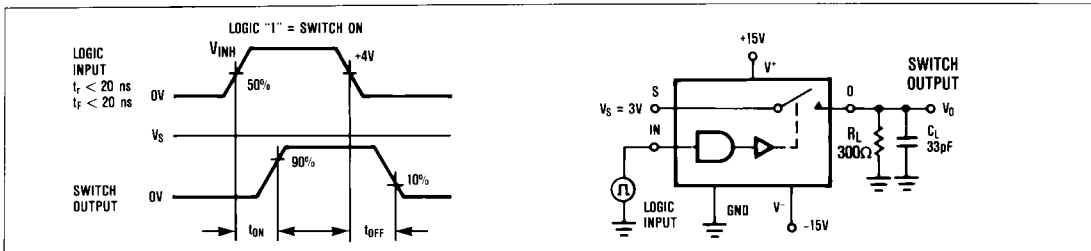

Figure 3. Switching Time Test Circuit.

All DG304 family switches will operate with  $\pm 15\text{V}$  power supplies. They can also be used with single ended power supplies ranging from +10V to +30V where the  $V^-$  terminal is connected to ground. In either case analog signals ranging from  $V^+$  to  $V^-$  can be switched.

The on resistance variation with analog signal and supply voltage is shown in the Typical Operating Characteristics graphs. The temperature coefficient of  $R_{ON}$  is typically  $0.5\%/^{\circ}\text{C}$ . Typical on resistance matching from channel to channel is 10%. In addition, Table 1 outlines some typical parameters for single supply operation.

### Application Information

Table 1. Typical Single Supply Parameters

	$V^+$ SUPPLY VOLTAGE ( $V^- = 0\text{V}$ )			
	+10V	+15V	+20V	+30V
Switching Time ( $R_L = 1\text{k}\Omega$ )				
$t_{ON}$	220ns	180ns	165ns	110ns
$t_{OFF}$	60ns	40ns	30ns	20ns
On Resistance				
$V_{\text{SIGNAL}} = +1\text{V}$	71 $\Omega$	51 $\Omega$	42 $\Omega$	31 $\Omega$
$V_{\text{SIGNAL}} = V^+/2$	77 $\Omega$	54 $\Omega$	43 $\Omega$	30 $\Omega$
$V_{\text{SIGNAL}} = V^+$	84 $\Omega$	63 $\Omega$	54 $\Omega$	43 $\Omega$
Input Logic Levels	3.5V, 11.0V	3.5V, 11.0V	3.5V, 12.5V	3.5V, 22.0V

The charge injection test circuit is shown in Figure 1. Table 2 lists the typical injected charge for DG304 series switches with various input voltages.

Table 2. Charge Injection ( $\pm 15\text{V}$  Supplies)

ANALOG INPUT	INJECTED Q
+10V	4pC
+5V	8pC
0V	12pC
-5V	8pC
-10V	5pC

## CMOS Analog Switches

### Ordering Information (continued)

**DG304(A)/DG305(A)/DG306(A)/DG307(A)**

PART	TEMP. RANGE	PACKAGE
DG304AC/D	0°C to +70°C	Dice
DG304ACJ	0°C to +70°C	14 Lead Plastic DIP
DG304ACWE	0°C to +70°C	16 Lead Wide SO
DG304ACK	0°C to +70°C	14 Lead CERDIP
DG304ABWE	-25°C to +85°C	16 Lead Wide SO
DG304ABK	-25°C to +85°C	14 Lead CERDIP
DG304ABA	-25°C to +85°C	10 Lead Metal Can
DG305C/D	0°C to +70°C	Dice
DG305CJ	0°C to +70°C	14 Lead Plastic DIP
DG305CWE	0°C to +70°C	16 Lead Wide SO
DG305CK	0°C to +70°C	14 Lead CERDIP
DG305BWE	-25°C to +85°C	16 Lead Wide SO
DG305BK	-25°C to +85°C	14 Lead CERDIP
DG305BA	-25°C to +85°C	10 Lead Metal Can
DG305AK	-55°C to +125°C	14 Lead CERDIP
DG305AA	-55°C to +125°C	10 Lead Metal Can
DG305AC/D	0°C to +70°C	Dice
DG305ACJ	0°C to +70°C	14 Lead Plastic DIP
DG305ACWE	0°C to +70°C	16 Lead Wide SO
DG305ACK	0°C to +70°C	14 Lead CERDIP
DG305ABWE	-25°C to +85°C	16 Lead Wide SO
DG305ABK	-25°C to +85°C	14 Lead CERDIP
DG305ABA	-25°C to +85°C	10 Lead Metal Can

PART	TEMP. RANGE	PACKAGE
DG306C/D	0°C to +70°C	Dice
DG306CJ	0°C to +70°C	14 Lead Plastic DIP
DG306CWE	0°C to +70°C	16 Lead Wide SO
DG306CK	0°C to +70°C	14 Lead CERDIP
DG306BWE	-25°C to +85°C	16 Lead Wide SO
DG306BK	-25°C to +85°C	14 Lead CERDIP
DG306AK	-55°C to +125°C	14 Lead CERDIP
DG306AC/D	0°C to +70°C	Dice
DG306ACJ	0°C to +70°C	14 Lead Plastic DIP
DG306ACWE	0°C to +70°C	16 Lead Wide SO
DG306ACK	0°C to +70°C	14 Lead CERDIP
DG306ABWE	-25°C to +85°C	16 Lead Wide SO
DG306ABK	-25°C to +85°C	14 Lead CERDIP
DG307C/D	0°C to +70°C	Dice
DG307CJ	0°C to +70°C	14 Lead Plastic DIP
DG307CWE	0°C to +70°C	16 Lead Wide SO
DG307CK	0°C to +70°C	14 Lead CERDIP
DG307BWE	-25°C to +85°C	16 Lead Wide SO
DG307BK	-25°C to +85°C	14 Lead CERDIP
DG307AK	-55°C to +125°C	14 Lead CERDIP
DG307AC/D	0°C to +70°C	Dice
DG307ACJ	0°C to +70°C	14 Lead Plastic DIP
DG307ACWE	0°C to +70°C	16 Lead Wide SO
DG307ACK	0°C to +70°C	14 Lead CERDIP
DG307ABWE	-25°C to +85°C	16 Lead Wide SO
DG307ABK	-25°C to +85°C	14 Lead CERDIP

# CMOS Analog Switches

## Package Information

(The package drawing(s) in this data sheet may not reflect the most current specifications. For the latest package outline information go to [www.maxim-ic.com/packages](http://www.maxim-ic.com/packages).)

**MAX304(A)/DG305(A)/DG306(A)/DG307(A)**

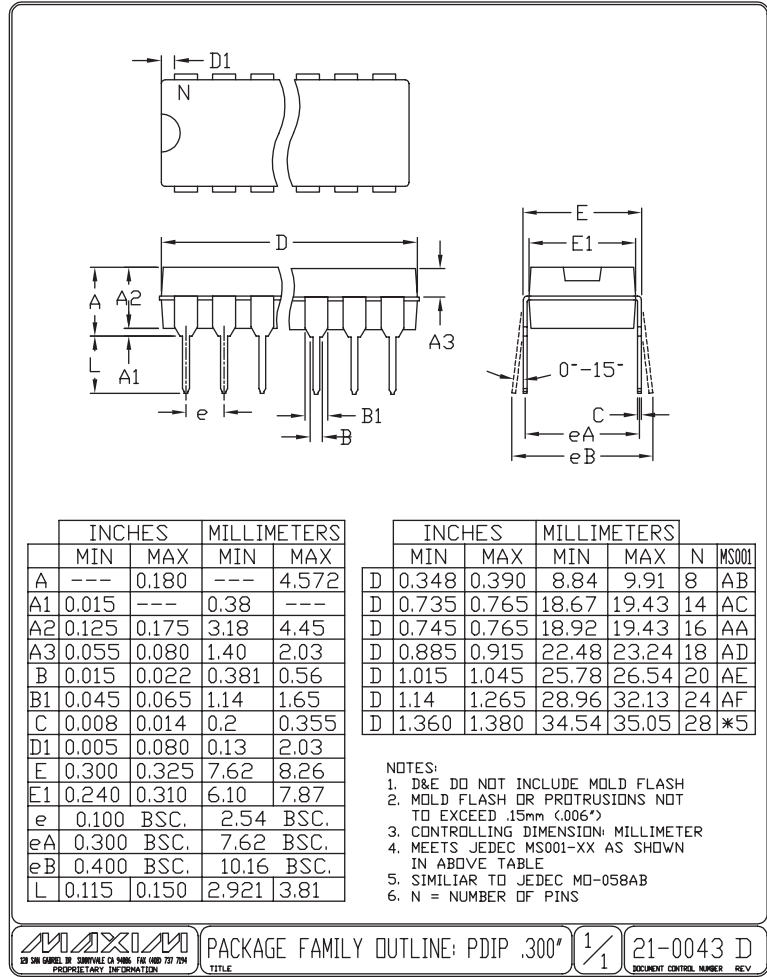

# CMOS Analog Switches

## Package Information (continued)

(The package drawing(s) in this data sheet may not reflect the most current specifications. For the latest package outline information go to [www.maxim-ic.com/packages](http://www.maxim-ic.com/packages).)

DG304(A)/DG305(A)/DG306(A)/DG307(A)

TOP VIEW

FRONT VIEW

SIDE VIEW

DIM	INCHES		MILLIMETERS	
	MIN	MAX	MIN	MAX
A	0.093	0.104	2.35	2.65
A1	0.004	0.012	0.10	0.30
B	0.014	0.019	0.35	0.49
C	0.009	0.013	0.23	0.32
e	0.050		1.27	
E	0.291	0.299	7.40	7.60
H	0.394	0.419	10.00	10.65
L	0.016	0.050	0.40	1.27

VARIATIONS:

DIM	INCHES		MILLIMETERS		N	MS013
	MIN	MAX	MIN	MAX		
D	0.398	0.413	10.10	10.50	16	AA
D	0.447	0.463	11.35	11.75	18	AB
D	0.496	0.512	12.60	13.00	20	AC
D	0.598	0.614	15.20	15.60	24	AD
D	0.697	0.713	17.70	18.10	28	AE

NOTES:

- D&E DO NOT INCLUDE MOLD FLASH.
- MOLD FLASH OR PROTRUSIONS NOT TO EXCEED 0.15mm (.006").
- LEADS TO BE COPLANAR WITHIN 0.10mm (.004").
- CONTROLLING DIMENSION: MILLIMETERS.
- MEETS JEDEC MS013.
- N = NUMBER OF PINS.

PROPRIETARY INFORMATION  
 TITLE: PACKAGE OUTLINE, .300" SOIC  
 APPROVAL: DOCUMENT CONTROL NO: 21-0042 REV: B 1/1

# CMOS Analog Switches

## Package Information (continued)

(The package drawing(s) in this data sheet may not reflect the most current specifications. For the latest package outline information go to [www.maxim-ic.com/packages](http://www.maxim-ic.com/packages).)

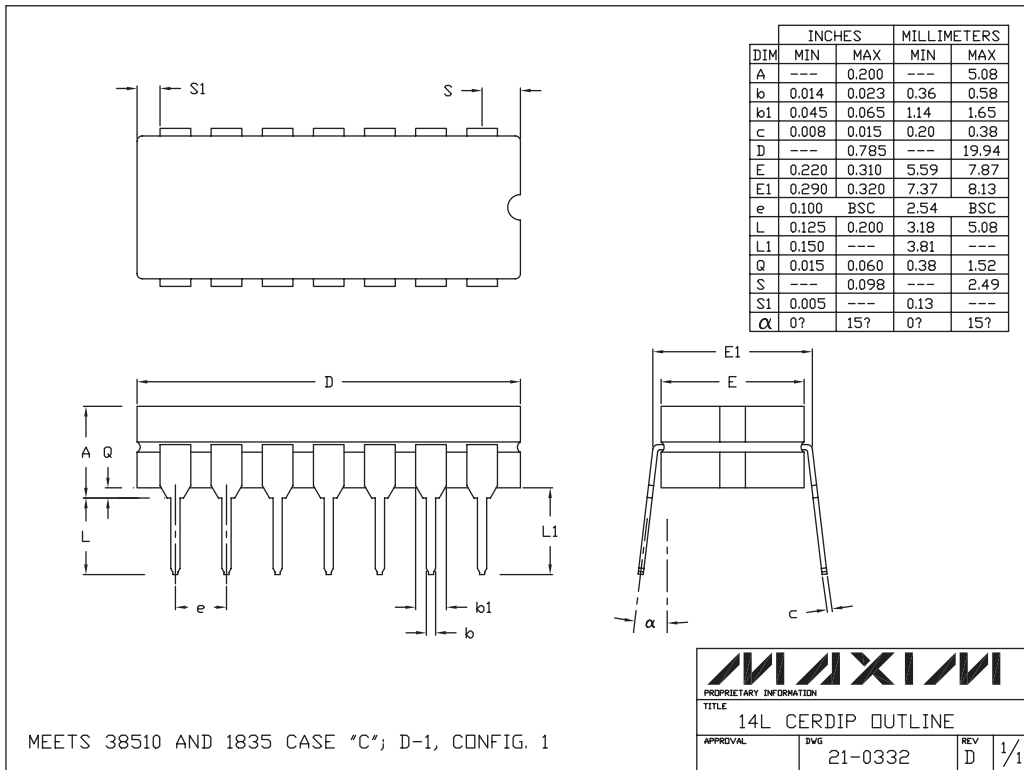

14L CERDIP EPS

MAX304(A)/DG305(A)/DG306(A)/DG307(A)



Maxim cannot assume responsibility for use of any circuitry other than circuitry entirely embodied in a Maxim product. No circuit patent licenses are implied. Maxim reserves the right to change the circuitry and specifications without notice at any time.

Maxim Integrated Products, 120 San Gabriel Drive, Sunnyvale, CA 94086 408-737-7600 9

© 2004 Maxim Integrated Products Printed USA MAXIM is a registered trademark of Maxim Integrated Products.

## Looking for pricing, stock, or lifecycle information?

Click below to explore more details on WIN SOURCE:

-  [View DG307ACJ on WIN SOURCE](#)
-  [Maxim Integrated Information](#)

## Optimize Your Supply Chain with WIN SOURCE Solutions

-  Global Sourcing Solution
-  Obsolete Management
-  Cost Control Management
-  Shortage Management
-  Alternative Solution
-  Excess Inventory Management