



**THE DATASHEET OF
DS3154N+**





DS3151/DS3152/DS3153/DS3154 Single/Dual/Triple/Quad DS3/E3/STS-1 LIUs

www.maxim-ic.com

GENERAL DESCRIPTION

The DS3151 (single), DS3152 (dual), DS3153 (triple), and DS3154 (quad) line interface units (LIUs) perform the functions necessary for interfacing at the physical layer to DS3, E3, or STS-1 lines. Each LIU has independent receive and transmit paths and a built-in jitter attenuator.

APPLICATIONS

SONET/SDH and PDH Multiplexers
Digital Cross-Connects
Access Concentrators
ATM and Frame Relay Equipment
Routers
PBXs
DSLAMs
CSUs/DSUs

FUNCTIONAL DIAGRAM

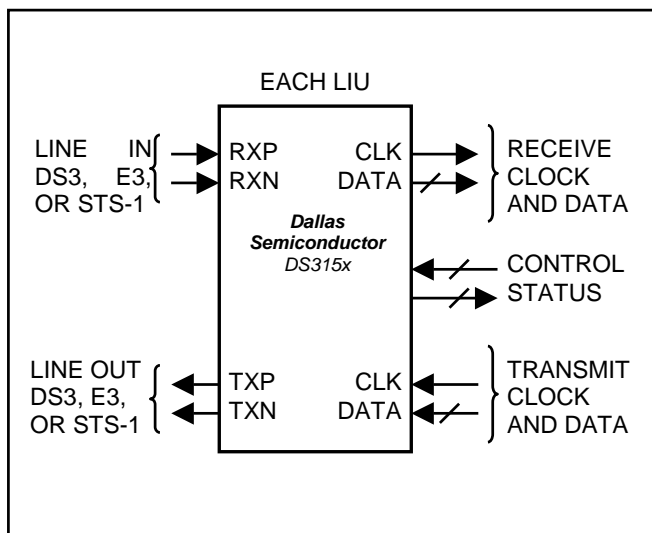

FEATURES

- Single, Dual, Triple, or Quad Integrated Transmitter, Receiver, and Jitter Attenuators for DS3, E3, and STS-1
- Each Port Independently Configurable
- Perform Receive Clock/Data Recovery and Transmit Waveshaping
- Hardware or CPU Bus Configuration Options
- Jitter Attenuators can be Placed in Either the Receive or Transmit Paths
- Interface to 75Ω Coaxial Cable at Lengths Up to 380m (DS3), 440m (E3), or 360m (STS-1)
- Use 1:2 Transformers on Tx and Rx
- Require Minimal External Components
- Local and Remote Loopbacks
- Low-Power 3.3V Operation (5V Tolerant I/O)
- Industrial Temperature Range: -40°C to +85°C
- Small Package: 144-Pin, 13mm x 13mm Thermally Enhanced CSBGA
- IEEE 1149.1 JTAG Support

Features continued on page 5.

ORDERING INFORMATION

| PART | LIUs | TEMP RANGE | PIN-PACKAGE |
|---------------|------|----------------|--------------|
| DS3151 | 1 | 0°C to +70°C | 144 TE-CSBGA |
| DS3151N | 1 | -40°C to +85°C | 144 TE-CSBGA |
| DS3152 | 2 | 0°C to +70°C | 144 TE-CSBGA |
| DS3152N | 2 | -40°C to +85°C | 144 TE-CSBGA |
| DS3153 | 3 | 0°C to +70°C | 144 TE-CSBGA |
| DS3153N | 3 | -40°C to +85°C | 144 TE-CSBGA |
| DS3154 | 4 | 0°C to +70°C | 144 TE-CSBGA |
| DS3154N | 4 | -40°C to +85°C | 144 TE-CSBGA |

Note: Some revisions of this device may incorporate deviations from published specifications known as errata. Multiple revisions of any device may be simultaneously available through various sales channels. For information about device errata, click here: www.maxim-ic.com/errata.

TABLE OF CONTENTS

| | | |
|-----|---|----|
| 1. | DETAILED DESCRIPTION..... | 5 |
| 2. | APPLICATIONS | 7 |
| 3. | HARDWARE MODE AND CPU BUS MODE..... | 8 |
| 4. | PIN DESCRIPTIONS | 10 |
| 5. | REGISTER DESCRIPTIONS..... | 15 |
| 6. | RECEIVER..... | 22 |
| 7. | TRANSMITTER | 25 |
| 8. | DIAGNOSTICS | 28 |
| 9. | JITTER ATTENUATOR | 29 |
| 10. | RESET LOGIC..... | 30 |
| 11. | TRANSFORMERS..... | 31 |
| 12. | JTAG TEST ACCESS PORT AND BOUNDARY SCAN | 32 |
| 13. | ELECTRICAL CHARACTERISTICS | 37 |
| 14. | PIN ASSIGNMENTS..... | 46 |
| 15. | PACKAGE INFORMATION..... | 59 |
| 16. | THERMAL INFORMATION | 60 |
| 17. | REVISION HISTORY | 61 |

LIST OF FIGURES

| | |
|--|----|
| Figure 1-1. External Connections | 7 |
| Figure 2-1. 4-Port Unchannelized DS3/E3 Card..... | 7 |
| Figure 3-1. Hardware Mode Block Diagram | 8 |
| Figure 3-2. CPU Bus Mode Block Diagram | 9 |
| Figure 5-1. Status Register Logic..... | 16 |
| Figure 6-1. Receiver Jitter Tolerance | 24 |
| Figure 7-1. E3 Waveform Template | 27 |
| Figure 7-2. DS3 AIS Structure..... | 28 |
| Figure 8-1. PRBS Output with Normal RCLK Operation | 29 |
| Figure 8-2. PRBS Output with Inverted RCLK Operation..... | 29 |
| Figure 9-1. Jitter Attenuation/Jitter Transfer | 30 |
| Figure 12-1. JTAG Block Diagram..... | 32 |
| Figure 12-2. JTAG TAP Controller State Machine..... | 33 |
| Figure 13-1. Transmitter Framer Interface Timing Diagram | 38 |
| Figure 13-2. Receiver Framer Interface Timing Diagram | 39 |
| Figure 13-3. CPU Bus Timing Diagram (Nonmultiplexed)..... | 41 |
| Figure 13-4. CPU Bus Timing Diagram (Multiplexed)..... | 43 |
| Figure 13-5. JTAG Timing Diagram..... | 45 |
| Figure 14-1. DS3151 Hardware Mode Pin Assignment..... | 51 |
| Figure 14-2. DS3151 CPU Bus Mode Pin Assignment..... | 52 |
| Figure 14-3. DS3152 Hardware Mode Pin Assignment..... | 53 |
| Figure 14-4. DS3152 CPU Bus Mode Pin Assignment..... | 54 |
| Figure 14-5. DS3153 Hardware Mode Pin Assignment..... | 55 |
| Figure 14-6. DS3153 CPU Bus Mode Pin Assignment..... | 56 |
| Figure 14-7. DS3154 Hardware Mode Pin Assignment..... | 57 |
| Figure 14-8. DS3154 CPU Bus Mode Pin Assignment..... | 58 |

LIST OF TABLES

| | |
|--|----|
| Table 1-A. Applicable Telecommunications Standards | 6 |
| Table 4-A. Active I/O Pins—Hardware and CPU Bus Modes | 10 |
| Table 4-B. Transmitter Pin Descriptions | 11 |
| Table 4-C. Receiver Pin Descriptions | 12 |
| Table 4-D. Global Pin Descriptions | 13 |
| Table 4-E. JTAG and Test Pin Descriptions | 14 |
| Table 4-F. Transmitter Data Select Options | 14 |
| Table 4-G. Receiver PRBS Pattern Select Options | 14 |
| Table 5-A. Register Map | 15 |
| Table 7-A. DS3 Waveform Template | 26 |
| Table 7-B. DS3 Waveform Test Parameters and Limits | 26 |
| Table 7-C. STS-1 Waveform Template | 26 |
| Table 7-D. STS-1 Waveform Test Parameters and Limits | 27 |
| Table 7-E. E3 Waveform Test Parameters and Limits | 27 |
| Table 11-A. Transformer Characteristics | 31 |
| Table 11-B. Recommended Transformers | 31 |
| Table 12-A. JTAG Instruction Codes | 35 |
| Table 12-B. JTAG ID Code | 35 |
| Table 13-A. Recommended DC Operating Conditions | 37 |
| Table 13-B. DC Characteristics | 37 |
| Table 13-C. Framer Interface Timing | 38 |
| Table 13-D. Receiver Input Characteristics—DS3 and STS-1 Modes | 39 |
| Table 13-E. Receiver Input Characteristics—E3 Mode | 39 |
| Table 13-F. Transmitter Output Characteristics—DS3 and STS-1 Modes | 40 |
| Table 13-G. Transmitter Output Characteristics—E3 Mode | 40 |
| Table 13-H. CPU Bus Timing | 40 |
| Table 13-I. JTAG Interface Timing | 45 |
| Table 14-A. Pin Assignments Sorted by Signal Name | 46 |
| Table 14-B. Pin Assignments Sorted by Pin Number | 48 |
| Table 16-A. Thermal Properties, Natural Convection | 60 |
| Table 16-B. Theta-JA (θ_{JA}) vs. Airflow | 60 |

FEATURES (continued)

Receiver

- AGC/equalizer block handles from 0 to 15dB of cable loss
- Loss-of-lock (LOL) PLL status indication
- Interfaces directly to a DSX monitor signal (~20dB flat loss) using built-in preamp
- Digital and analog loss-of-signal (LOS) detectors (ANSI T1.231 and ITU G.775)
- Optional B3ZS/HDB3 decoder
- Line-code violation output pin and counter
- Binary or bipolar framer interface
- On-board $2^{15} - 1$ and $2^{23} - 1$ PRBS detector
- Clock inversion for glueless interfacing
- Tri-state clock and data outputs support protection switching applications
- Per-channel power-down control

Transmitter

- Binary or bipolar framer interface
- Gapped clock capable up to 51.84MHz
- Wide $50 \pm 20\%$ transmit clock duty cycle
- Clock inversion for glueless interfacing
- Optional B3ZS/HDB3 encoder
- On-board $2^{15} - 1$ and $2^{23} - 1$ PRBS generator
- Complete DS3 AIS generator (ANSI T1.107)
- Unframed all-ones generator (E3 AIS)
- Line build-out (LBO) control
- Tri-state line driver outputs support protection switching applications
- Per-channel power-down control
- Output driver monitor

1. DETAILED DESCRIPTION

The DS3151 (single), DS3152 (dual), DS3153 (triple), and DS3154 (quad) LIUs perform the functions necessary for interfacing at the physical layer to DS3, E3, or STS-1 lines. Each LIU has independent receive and transmit paths and a built-in jitter attenuator. The receiver performs clock and data recovery from a B3ZS- or HDB3-coded alternate mark inversion (AMI) signal and monitors for loss of the incoming signal. The receiver optionally performs B3ZS/HDB3 decoding and outputs the recovered data in either binary or bipolar format. The transmitter accepts data in either binary or bipolar format, optionally performs B3ZS/HDB3 encoding, and drives standard pulse-shape waveforms onto 75Ω coaxial cable. The jitter attenuator can be mapped into the receiver data path, mapped into the transmitter data path, or be disabled. The DS315x LIUs conform to the telecommunications standards listed in [Table 1-A](#). [Figure 1-1](#) shows the external components required for proper operation.

Table 1-A. Applicable Telecommunications Standards

| SPECIFICATION | SPECIFICATION TITLE |
|----------------------|--|
| ANSI | |
| T1.102-1993 | <i>Digital Hierarchy—Electrical Interfaces</i> |
| T1.107-1995 | <i>Digital Hierarchy—Formats Specification</i> |
| T1.231-1997 | <i>Digital Hierarchy—Layer 1 In-Service Digital Transmission Performance Monitoring</i> |
| T1.404-1994 | <i>Network-to-Customer Installation—DS3 Metallic Interface Specification</i> |
| ITU-T | |
| G.703 | <i>Physical/Electrical Characteristics of Hierarchical Digital Interfaces, 1991</i> |
| G.751 | <i>Digital Multiplex Equipment Operating at the Third-Order Bit Rate of 34,368kbps and the Fourth-Order Bit Rate of 139,264kbps and Using Positive Justification, 1993</i> |
| G.775 | <i>Loss of Signal (LOS) and Alarm Indication Signal (AIS) Defect Detection and Clearance Criteria, November 1994</i> |
| G.823 | <i>The Control of Jitter and Wander within Digital Networks that are Based on the 2048kbps Hierarchy, 1993</i> |
| G.824 | <i>The Control of Jitter and Wander within Digital Networks that are Based on the 1544kbps Hierarchy, 1993</i> |
| O.151 | <i>Error Performance Measuring Equipment Operating at the Primary Rate and Above, October 1992</i> |
| ETSI | |
| ETS 300 686 | <i>Business TeleCommunications; 34Mbps and 140Mbps Digital Leased Lines (D34U, D34S, D140U, and D140S); Network Interface Presentation, 1996</i> |
| ETS 300 687 | <i>Business TeleCommunications; 34Mbps Digital Leased Lines (D34U and D34S); Connection Characteristics, 1996</i> |
| ETS EN 300 689 | <i>Access and Terminals (AT); 34Mbps Digital Leased Lines (D34U and D34S); Terminal equipment interface, July 2001</i> |
| TBR 24 | <i>Business TeleCommunications; 34Mbps Digital Unstructured and Structured Lease Lines; Attachment Requirements for Terminal Equipment Interface, 1997</i> |
| TELCORDIA | |
| GR-253-CORE | <i>SONET Transport Systems: Common Generic Criteria, Issue 2, December 1995</i> |
| GR-499-CORE | <i>Transport Systems Generic Requirements (TSGR): Common Requirements, Issue 1, December 1998</i> |

Figure 1-1. External Connections

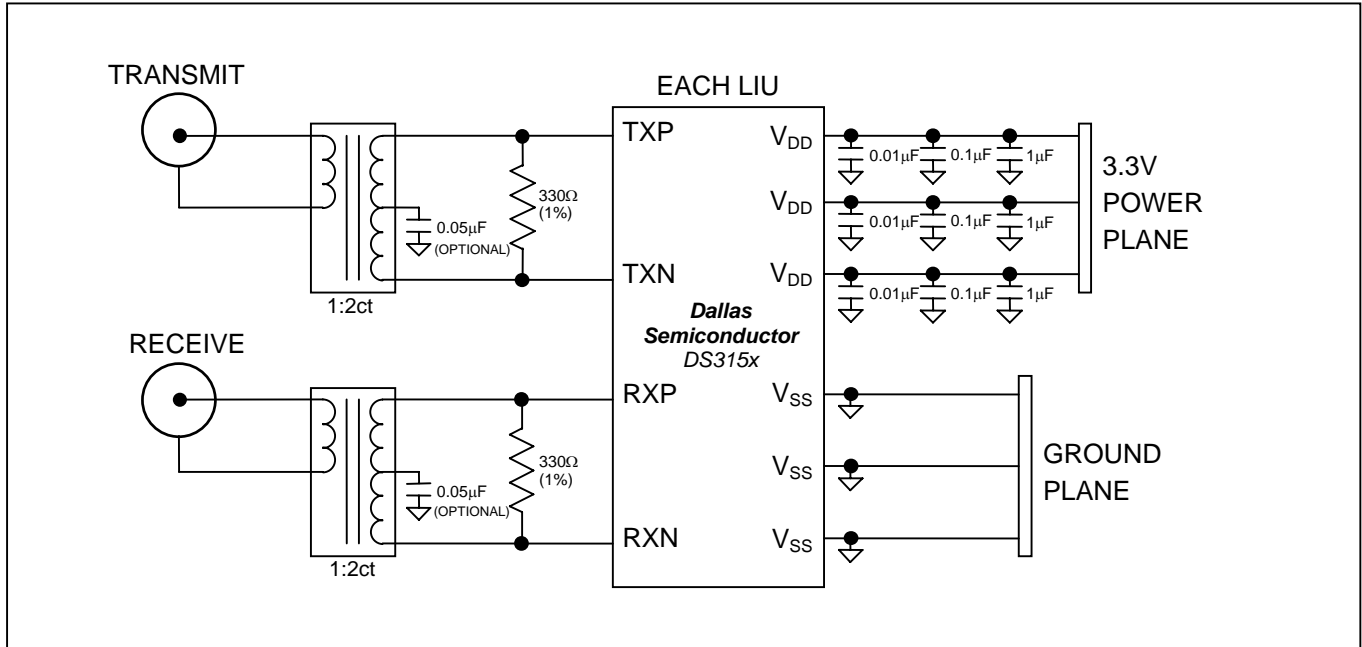

2. APPLICATIONS

Figure 2-1. 4-Port Unchannelized DS3/E3 Card

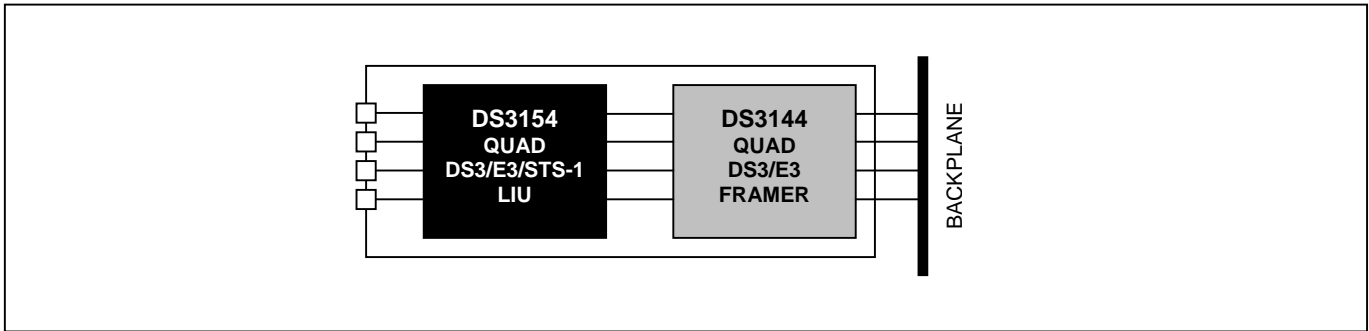

Shorthand Notations. The notation “DS315x” throughout this data sheet refers to either the DS3151, DS3152, DS3153, or DS3154. This data sheet is the specification for all four parts. The LIUs on the DS315x are identical. For brevity, this document uses the pin and register name shorthand “NAME_n,” where “n” stands in place of the LIU port number. For example, on the DS3154 quad LIU, TCLK_n is shorthand notation for pins TCLK1, TCLK2, TCLK3, and TCLK4 on LIU ports 1, 2, 3, and 4, respectively. This document also uses generic pin and register names such as TCLK (without a number suffix) when describing LIU operation. When working with a specific LIU on the DS315x devices, generic names like TCLK should be converted to actual pin names, such as TCLK1.

Figure 3-2. CPU Bus Mode Block Diagram

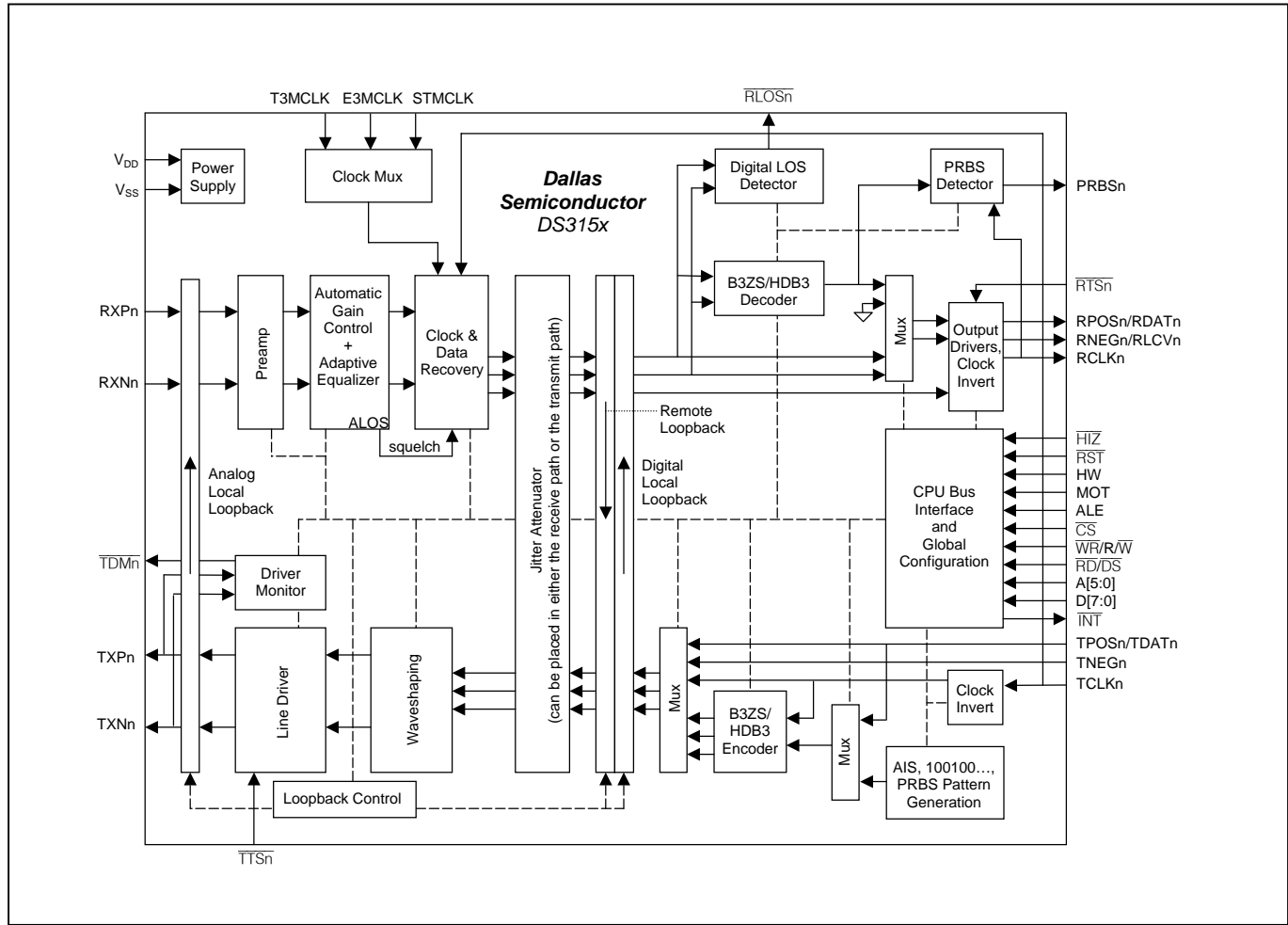

4. PIN DESCRIPTIONS

Table 4-A. Active I/O Pins—Hardware and CPU Bus Modes

| NAME | TYPE | FUNCTION | HARDWARE MODE | CPU BUS MODE |
|--------------------|------|---|---------------|--------------|
| TRANSMITTER | | | | |
| TCLKn | I | Transmitter Clock | Active | Active |
| TPOSn/TDATn | I | Transmitter Positive AMI/Transmitter Data | Active | Active |
| TNEGn | I | Transmitter Negative AMI | Active | Active |
| TXPn, TXNn | O | Transmitter Analog Outputs | Active | Active |
| TTSn | I | Transmitter Tri-State Enable | Active | Active |
| TDMn | O | Transmitter Driver Monitor Output | Active | Active |
| TDSAn, TDSBn | I | Transmitter Data Select | Active | |
| TLBOn | I | Transmitter Line Build-Out Enable | Active | |
| TJAn | I | Transmitter Jitter Attenuator Enable | Active | |
| RECEIVER | | | | |
| RXPn, RXNn | I | Receiver Analog Inputs | Active | Active |
| RCLKn | O | Receiver Clock | Active | Active |
| RPOSn/RDATn | O | Receiver Positive AMI/Receiver Data | Active | Active |
| RNEGn/RLCVn | O | Receiver Negative AMI/Line-Code Violation | Active | Active |
| RTSn | I | Receiver Tri-State Enable | Active | Active |
| RLOSn | O | Receiver LOS Output | Active | Active |
| RMONn | I | Receiver Monitor Enable | Active | |
| RJAn | I | Receiver Jitter Attenuator Enable | Active | |
| GLOBAL | | | | |
| HIZ | I | High-Z Enable | Active | Active |
| RST | I | Reset Enable | Active | Active |
| HW | I | Hardwired Mode Enable | Active | Active |
| T3MCLK | I | T3 Master Clock (44.736MHz ±20ppm) | Active | Active |
| E3MCLK | I | E3 Master Clock (34.368MHz ±20ppm) | Active | Active |
| STMCLK | I | STS-1 Master Clock (51.840MHz ±20ppm) | Active | Active |
| PRBSn | O | PRBS Detector Output | Active | Active |
| LLBn, RLBn | I | Local Loopback, Remote Loopback Select | Active | |
| E3Mn, STSn | I | E3 Mode Enable, STS-1 Mode Enable | Active | |
| RBIN | I | Receiver Binary Interface Enable | Active | |
| TBIN | I | Transmitter Binary Interface Enable | Active | |
| RCINV | I | Receiver Clock Invert | Active | |
| TCINV | I | Transmitter Clock Invert | Active | |
| MOT | I | Motorola CPU Bus Enable | | Active |
| ALE | I | Address Latch Enable | | Active |
| CS | I | Chip Select | | Active |
| WR / RW | I | Write Enable / Read/Write Select | | Active |
| RD/DS | I | Read Enable/Data Strobe | | Active |
| A[5:0] | I | Address Bus | | Active |
| D[7:0] | I/O | Data Bus | | Active |
| INT | O | Interrupt Output | | Active |

Note: In CPU bus mode, status/control pins are replaced by register bits. See *Register Map* in Section 5. For pin names of the form PINn, n = LIU# = 1, 2, 3, or 4. PIN1 is on LIU 1, PIN2 is on LIU 2, etc.

Table 4-B. Transmitter Pin Descriptions

| NAME | I/O | FUNCTION |
|--|-----|---|
| TCLK _n | I | Transmitter Clock. A DS3 (44.736MHz ±20ppm), E3 (34.368MHz ±20ppm), or STS-1 (51.840MHz ±20ppm) clock should be applied at this signal. Data to be transmitted is clocked into the device at TPOS/TDAT and TNEG either on the rising edge of TCLK (TCINV = 0) or the falling edge of TCLK (TCINV = 1). See Section 7 for additional details. |
| TPOS _n / TDAT _n | I | Transmitter Positive AMI/Transmitter Data. When the transmitter is configured to have a bipolar interface (TBIN = 0), a positive pulse is transmitted on the line when TPOS is high. When the transmitter is configured to have a binary interface (TBIN = 1), the data on TDAT is transmitted after B3ZS or HDB3 encoding. TPOS/TDAT is sampled either on the rising edge of TCLK (TCINV = 0) or on the falling edge of TCLK (TCINV = 1). |
| TNEG _n | I | Transmitter Negative AMI. When the transmitter is configured to have a bipolar interface (TBIN = 0), a negative pulse is transmitted on the line when TNEG is high. When the transmitter is configured to have a binary interface (TBIN = 1), TNEG is ignored and should be wired either high or low. TNEG is sampled either on the rising edge of TCLK (TCINV = 0) or on the falling edge of TCLK (TCINV = 1). |
| TXP _n , TXN _n | O3 | Transmitter Analog Outputs. These differential AMI outputs are coupled to the outbound 75Ω coaxial cable through a 2:1 step-down transformer (Figure 1-1). These outputs can be tri-stated using the $\overline{\text{TTS}}$ pin or the TTS or TPS configuration bits. |
| $\overline{\text{TTS}}_n$ | I | Transmitter Tri-State Enable (Active Low). $\overline{\text{TTS}}$ tri-states the transmitter outputs (TXP and TXN). This feature supports applications requiring LIU redundancy. Transmitter outputs from multiple LIUs can be wire-ORed together, eliminating external switches. The transmitter continues to operate internally when $\overline{\text{TTS}}$ is active. 0 = tri-state the transmitter output driver 1 = enable the transmitter output driver |
| $\overline{\text{TDM}}_n$ | O | Transmitter Driver Monitor (Active Low, Open Drain). $\overline{\text{TDM}}$ reports the status of the transmit driver monitor. When the transmit driver monitor detects a faulty transmitter, $\overline{\text{TDM}}$ is driven low. $\overline{\text{TDM}}$ requires an external pullup to V _{DD} . |
| TDSAn, TDSBn | I | Transmitter Data Select. These inputs select the source of the transmit data. See Table 4-F for details. |
| TLBO _n | I | Transmitter Line Build-Out Enable. TLBO indicates cable length for waveform shaping in DS3 and STS-1 modes. TLBO is ignored for E3 mode and should be wired high or low. 0 = cable length ≥ 225ft 1 = cable length < 225ft |
| TJAn | I | Transmitter Jitter Attenuator Enable 0 = remove jitter attenuator from the transmitter path 1 = insert jitter attenuator into the transmitter path (Note that TJA = 1 takes precedence over RJA = 1.) |

Table 4-C. Receiver Pin Descriptions

| NAME | I/O | FUNCTION |
|----------------------------|-----|---|
| RXPn, RXNn | I | Receiver Analog Inputs. These differential AMI inputs are coupled to the inbound 75Ω coaxial cable through a 1:2 step-up transformer (Figure 1-1). |
| RCLKn | O3 | Receiver Clock. The recovered clock is output on the RCLK pin. Recovered data is output on the RPOS/RDAT and RNEG/RLCV pins on the falling edge of RCLK (RCINV = 0) or the rising edge of RCLK (RCINV = 1). During a loss of signal ($\overline{\text{RLOS}} = 0$), the RCLK output signal is derived from the LIU's master clock. |
| RPOSn/ RDATn | O3 | Receiver Positive AMI/Receiver Data. When the receiver is configured to have a bipolar interface (RBIN = 0), RPOS pulses high for each positive AMI pulse received. When the receiver is configured to have a binary interface (RBIN = 1), RDAT outputs decoded binary data. RPOS/RDAT is updated either on the falling edge of RCLK (RCINV = 0) or the rising edge of RCLK (RCINV = 1). |
| RNEGn/ RLCVn | O3 | Receiver Negative AMI/Line-Code Violation. When the receiver is configured to have a bipolar interface (RBIN = 0), RNEG pulses high for each negative AMI pulse received. When the receiver is configured to have a binary interface (RBIN = 1), RLCV pulses high to flag code violations. See Section 6 for further details on code violations. RNEG/RLCV is updated either on the falling edge of RCLK (RCINV = 0) or the rising edge of RCLK (RCINV = 1). |
| $\overline{\text{RTS}}_n$ | I | Receiver Tri-State Enable (Active Low). $\overline{\text{RTS}}$ tri-states the RPOS/RDAT, RNEG/RLCV, and RCLK receiver outputs. This feature supports applications requiring LIU redundancy. Receiver outputs from multiple LIUs can be wire-ORed together, eliminating the need for external switches or muxes. The receiver continues to operate internally when $\overline{\text{RTS}}$ is low. 0 = tri-state the receiver outputs 1 = enable the receiver outputs |
| $\overline{\text{RLOS}}_n$ | O | Receiver Loss of Signal (Active Low, Open Drain). $\overline{\text{RLOS}}$ is asserted upon detection of 175 ±75 consecutive zeros in the receive data stream. $\overline{\text{RLOS}}$ is deasserted when there are no excessive zero occurrences over a span of 175 ±75 clock periods. An excessive zero occurrence is defined as three or more consecutive zeros in the DS3 and STS-1 modes or four or more zeros in the E3 mode. See Section 6 for additional details. |
| RMONn | I | Receive Monitor-Preamp Enable. RMON determines whether or not the receiver's preamp is enabled to provide flat gain to the incoming signal before the AGC/equalizer block processes it. This feature should be enabled when the device is being used to monitor signals that have been resistively attenuated by a monitor jack. 0 = disable the monitor preamp 1 = enable the monitor preamp |
| RJAn | I | Receiver Jitter Attenuator Enable 0 = remove jitter attenuator from the receiver path 1 = insert jitter attenuator into the receiver path (Note that TJA = 1 takes precedence over RJA = 1.) |

Table 4-D. Global Pin Descriptions

| NAME | I/O | FUNCTION |
|--|-----------------|--|
| $\overline{\text{HIZ}}$ | I _{PU} | High-Z Enable Input (Active Low, Open Drain) 0 = tri-state all output pins (Note that the $\overline{\text{JTRST}}$ pin must be low.) 1 = normal operation |
| $\overline{\text{RST}}$ | I _{PU} | Reset Input (Active Low, Open Drain, Internal 10k Ω Pullup to V _{DD}). When this global asynchronous reset is pulled low, the internal circuitry is reset and the internal registers (CPU bus mode) are forced to their default values. The device is held in reset as long as $\overline{\text{RST}}$ is low. $\overline{\text{RST}}$ should be held low for at least two master clock cycles. |
| HW | I | Hardwired Mode Select 0 = CPU bus mode 1 = hardwired mode See Section 3 for details. |
| T3MCLK | I | T3 Master Clock. A transmission-quality DS3 (44.736MHz \pm 20ppm, low jitter) clock should be applied at this pin. Wiring T3MCLK high forces LIUs in DS3 mode to use TCLK for receiver clock and data recovery. |
| E3MCLK | I | E3 Master Clock. A transmission-quality E3 (34.368MHz \pm 20ppm, low jitter) clock should be applied at this pin. Wiring E3MCLK high forces LIUs in E3 mode to use TCLK for receiver clock and data recovery. |
| STMCLK | I | STS-1 Master Clock. A transmission-quality STS-1 (51.840MHz \pm 20ppm, low jitter) clock should be applied at this pin. Wiring STMCLK high forces LIUs in STS-1 mode to use TCLK for receiver clock and data recovery. |
| PRBSn | O | PRBS Detector Output. This signal reports the status of the PRBS detector. See Section 8 for further details. |
| LLBn, RLBn | I | Local Loopback Select, Remote Loopback Select {LLB, RLB} = 00 = no loopback 01 = remote loopback 10 = analog local loopback 11 = digital local loopback |
| E3Mn | I | E3 Mode Enable 0 = DS3 operation 1 = E3 or STS-1 operation |
| STSn | I | STS-1 Mode Enable When E3M = 1, 0 = E3 operation 1 = STS-1 operation When E3M = 0, STS selects the DS3 AIS pattern. |
| RBIN | I | Receiver Binary Framer-Interface Enable 0 = Receiver framer interface is bipolar on the RPOS and RNEG pins. The B3ZS/HDB3 decoder is disabled. 1 = Receiver framer interface is binary on the RDAT pin with the RLCV pin indicating line-code violations. The B3ZS/HDB3 encoder is enabled. |
| TBIN | I | Transmitter Binary Framer-Interface Enable 0 = Transmitter framer interface is bipolar on the TPOS and TNEG pins. The B3ZS/HDB3 encoder is disabled. 1 = Transmitter framer interface is binary on the TDAT pin. (TNEG is ignored and should be wired low.) The B3ZS/HDB3 encoder is enabled. |
| RCINV | I | Receiver Clock Invert 0 = RPOS/RDAT and RNEG/RLCV update on the falling edge of RCLK. 1 = RPOS/RDAT and RNEG/RLCV update on the rising edge of RCLK. |
| TCINV | I | Transmitter Clock Invert 0 = TPOS/TDAT and TNEG are sampled on the rising edge of TCLK. 1 = TPOS/TDAT and TNEG are sampled on the falling edge of TCLK. |
| MOT | I | Motorola Bus Mode Enable 0 = Intel bus mode 1 = Motorola bus mode |
| ALE | I | Address Latch Enable. This signal controls a latch on the A[5:0] inputs. In nonmultiplexed bus applications, ALE should be wired high to make the latch transparent. In multiplexed bus applications, A[5:0] should be wired to D[5:0]. The falling edge of ALE latches the address. |
| $\overline{\text{CS}}$ | I | Chip Select (Active Low). $\overline{\text{CS}}$ must be asserted in order to read or write internal registers. |
| $\overline{\text{WR}} / \text{R}\overline{\text{W}}$ | I | Write Enable (Active Low) or Read/Write Select. In Intel bus mode (MOT = 0), $\overline{\text{WR}}$ is asserted to write internal registers. In Motorola bus mode (MOT = 1), $\text{R}\overline{\text{W}}$ determines the type of bus |

| NAME | I/O | FUNCTION |
|-------------------------------|-----|--|
| | | transaction, with $R/\overline{W} = 1$ indicating a read and $R/\overline{W} = 0$ indicating a write. |
| $\overline{RD}/\overline{DS}$ | I | Read Enable (Active Low) or Data Strobe (Active Low). In Intel bus mode (MOT = 0), \overline{RD} is asserted to read internal registers. In Motorola bus mode (MOT = 1), the rising edge of \overline{DS} writes data to internal registers. |
| A[5:0] | I | Address Bus. These inputs specify the address of the internal register to be accessed. A5 is not present on the DS3152. A5 and A4 are not present on the DS3151. |
| D[7:0] | I/O | Data Bus. These bidirectional lines are inputs during writes to internal registers. They are outputs during reads from internal registers. |
| \overline{INT} | O | Interrupt Output (Active Low, Open Drain). This pin is forced low in response to one or more unmasked, active interrupt sources within the device. \overline{INT} remains low until the interrupt is serviced or masked. |
| V_{DD} | P | Positive Supply. 3.3V \pm 5%. All V_{DD} signals should be wired together. |
| V_{SS} | P | Ground Reference. All V_{SS} signals should be wired together. |

Table 4-E. JTAG and Test Pin Descriptions

| NAME | I/O | FUNCTION |
|-------------------|-----------------|--|
| JTCLK | I | JTAG IEEE 1149.1 Test Serial Clock. JTCLK shifts data into JTDI on the rising edge and out of JTDO on the falling edge. If boundary scan is not used, JTCLK should be pulled high. |
| JTDI | I _{PU} | JTAG IEEE 1149.1 Test Serial-Data Input (Internal 10kΩ Pullup). Test instructions and data are clocked in on this pin on the rising edge of JTCLK. If boundary scan is not used, JTDI should be left unconnected or pulled high. |
| JTDO | O | JTAG IEEE 1149.1 Test Serial-Data Output. Test instructions and data are clocked out on this pin on the falling edge of JTCLK. |
| JTRST | I _{PU} | JTAG IEEE 1149.1 Test Reset (Internal 10kΩ Pullup). This pin is used to asynchronously reset the test access port (TAP) controller. If boundary scan is not used, JTRST can be held low or high. |
| JTMS | I _{PU} | JTAG IEEE 1149.1 Test Mode Select (Internal 10kΩ Pullup). This pin is sampled on the rising edge of JTCLK and is used to place the port into the various defined IEEE 1149.1 states. If boundary scan is not used, JTMS should be left unconnected or pulled high. |
| \overline{TEST} | I _{PU} | Factory Test Pin. Leave unconnected or wire high for normal operation. |

Note 1: Pin type I = input pin. Pin type O = output pin. Pin type P = power-supply pin.

Note 2: Pin type O3 is an output that can be tri-stated.

Note 3: Pin type I_{PU} is an input with an internal 10kΩ pullup.

Note 4: For pin names of the form PINn, n = LIU# = 1, 2, 3, or 4. PIN1 is on LIU 1, PIN2 is on LIU 2, etc.

Note 5: Section 14 shows hardware mode and CPU bus mode pin assignments.

Table 4-F. Transmitter Data Select Options

| TDSA | TDSB | E3M | STS | Tx MODE | TRANSMIT DATA SELECTED |
|------|------|-----|-----|---------|--|
| 0 | 0 | X | X | Any | Normal data as input at TPOS and TNEG |
| 0 | 1 | 0 | 0 | DS3 | Unframed all ones |
| 0 | 1 | 1 | 0 | E3 | |
| 0 | 1 | 1 | 1 | STS-1 | |
| 0 | 1 | 0 | 1 | DS3 | DS3 AIS per ANSI T1.107 (Figure 7-2) |
| 1 | 0 | X | X | Any | Unframed 100100... pattern |
| 1 | 1 | 1 | 0 | E3 | 2 ²³ - 1 PRBS pattern per ITU O.151 |
| 1 | 1 | 0 | X | DS3 | 2 ¹⁵ - 1 PRBS pattern per ITU O.151 |
| 1 | 1 | 1 | 1 | STS-1 | |

Note 1: This coding of the TDSA, TDSB, E3M, and STS bits allows AIS generation to be enabled by holding TDSA = 0 and changing TDSB from 0 to 1. The type of DS3 AIS signal is selected by the STS bit with E3M = 0.

Note 2: If E3M and/or STS are changed when {TDSA, TDSB} ≠ 00, TDSA and TDSB must both be cleared to 0. After they are cleared, TDSA and TDSB can be configured to transmit a pattern in the new operating mode.

Table 4-G. Receiver PRBS Pattern Select Options

| E3M | STS | Rx MODE | RECEIVER PRBS PATTERN SELECTED |
|-----|-----|---------|--|
| 1 | 0 | E3 | 2 ²³ - 1 PRBS pattern per ITU O.151 |
| 0 | X | DS3 | 2 ¹⁵ - 1 PRBS pattern per ITU O.151 |
| 1 | 1 | STS-1 | |

5. REGISTER DESCRIPTIONS

When the DS315x is configured in CPU bus mode (HW = 0), the registers shown in [Table 5-A](#) are accessible through the CPU bus interface. All registers for the LIU ports are forced to their default values during an internal power-on reset or when the $\overline{\text{RST}}$ pin is driven low. Setting an LIU's RST bit high forces all registers for that LIU to their default values. All register bits marked “—” must be written 0 and ignored when read. The TEST registers must be left at their reset value of 00h for normal operation.

On the DS3153, only registers for LIUs 1, 2, and 3 are available. Writes into LIU 4 address space are ignored. Reads from LIU 4 address space return all zeros. On the DS3152, address line A5 is not present, limiting the address space to the LIU 1 and 2 registers. On the DS3151, address lines A5 and A4 are not present, limiting the address space to the LIU 1 registers.

Table 5-A. Register Map

| ADDRESS | REGISTER | BIT 7 | BIT 6 | BIT 5 | BIT 4 | BIT 3 | BIT 2 | BIT 1 | BIT 0 |
|--------------|----------|---------|---------|------------|-------------|---------|---------|-------------|-------------|
| LIU 1 | | | | | | | | | |
| 00h | GCR1 | E3M | STS | LLB | RLB | TDSA | TDSB | — | RST |
| 01h | TCR1 | — | TBIN | TCINV | TJA | TPD | TTS | TLBO | — |
| 02h | RCR1 | ITU | RBIN | RCINV | RJA | RPD | RTS | RMON | RCVUD |
| 03h | SR1 | — | — | <u>TDM</u> | <u>PRBS</u> | — | — | <u>RLOL</u> | <u>RLOS</u> |
| 04h | SRL1 | — | — | TDML | PRBSL | PBERL | RCVL | RLOL | RLOSL |
| 05h | SRIE1 | — | — | TDMIE | PRBSIE | PBERIE | RCVIE | RLOLIE | RLOSIE |
| 06h | RCVL1 | RCV[7] | RCV[6] | RCV[5] | RCV[4] | RCV[3] | RCV[2] | RCV[1] | RCV[0] |
| 07h | RCVH1 | RCV[15] | RCV[14] | RCV[13] | RCV[12] | RCV[11] | RCV[10] | RCV[9] | RCV[8] |
| 08h–0Fh | TEST | — | — | — | — | — | — | — | — |
| LIU 2 | | | | | | | | | |
| 10h | GCR2 | E3M | STS | LLB | RLB | TDSA | TDSB | -- | RST |
| 11h | TCR2 | — | TBIN | TCINV | TJA | TPD | TTS | TLBO | -- |
| 12h | RCR2 | ITU | RBIN | RCINV | RJA | RPD | RTS | RMON | RCVUD |
| 13h | SR2 | — | — | <u>TDM</u> | <u>PRBS</u> | — | — | <u>RLOL</u> | <u>RLOS</u> |
| 14h | SRL2 | — | — | TDML | PRBSL | PBERL | RCVL | RLOL | RLOSL |
| 15h | SRIE2 | — | — | TDMIE | PRBSIE | PBERIE | RCVIE | RLOLIE | RLOSIE |
| 16h | RCVL2 | RCV[7] | RCV[6] | RCV[5] | RCV[4] | RCV[3] | RCV[2] | RCV[1] | RCV[0] |
| 17h | RCVH2 | RCV[15] | RCV[14] | RCV[13] | RCV[12] | RCV[11] | RCV[10] | RCV[9] | RCV[8] |
| 18h–1Fh | TEST | — | — | — | — | — | — | — | — |
| LIU 3 | | | | | | | | | |
| 20h | GCR3 | E3M | STS | LLB | RLB | TDSA | TDSB | — | RST |
| 21h | TCR3 | — | TBIN | TCINV | TJA | TPD | TTS | TLBO | — |
| 22h | RCR3 | ITU | RBIN | RCINV | RJA | RPD | RTS | RMON | RCVUD |
| 23h | SR3 | — | — | <u>TDM</u> | <u>PRBS</u> | — | — | <u>RLOL</u> | <u>RLOS</u> |
| 24h | SRL3 | — | — | TDML | PRBSL | PBERL | RCVL | RLOL | RLOSL |
| 25h | SRIE3 | — | — | TDMIE | PRBSIE | PBERIE | RCVIE | RLOLIE | RLOSIE |
| 26h | RCVL3 | RCV[7] | RCV[6] | RCV[5] | RCV[4] | RCV[3] | RCV[2] | RCV[1] | RCV[0] |
| 27h | RCVH3 | RCV[15] | RCV[14] | RCV[13] | RCV[12] | RCV[11] | RCV[10] | RCV[9] | RCV[8] |
| 28h–2Fh | TEST | — | — | — | — | — | — | — | — |
| LIU 4 | | | | | | | | | |
| 30h | GCR4 | E3M | STS | LLB | RLB | TDSA | TDSB | — | RST |
| 31h | TCR4 | — | TBIN | TCINV | TJA | TPD | TTS | TLBO | — |
| 32h | RCR4 | ITU | RBIN | RCINV | RJA | RPD | RTS | RMON | RCVUD |
| 33h | SR4 | — | — | <u>TDM</u> | <u>PRBS</u> | — | — | <u>RLOL</u> | <u>RLOS</u> |
| 34h | SRL4 | — | — | TDML | PRBSL | PBERL | RCVL | RLOL | RLOSL |
| 35h | SRIE4 | — | — | TDMIE | PRBSIE | PBERIE | RCVIE | RLOLIE | RLOSIE |
| 36h | RCVL4 | RCV[7] | RCV[6] | RCV[5] | RCV[4] | RCV[3] | RCV[2] | RCV[1] | RCV[0] |
| 37h | RCVH4 | RCV[15] | RCV[14] | RCV[13] | RCV[12] | RCV[11] | RCV[10] | RCV[9] | RCV[8] |
| 38h–3Fh | TEST | — | — | — | — | — | — | — | — |

Note 1: Underlined bits are read-only; all other bits are read-write.

Note 2: The registers are named REG_n, where n = the LIU number (1, 2, 3, or 4).

Note 3: The bit names are the same for each LIU register set.

Status Register Description

The status registers have two types of status bits. Real-time status bits—located in the SRn registers—indicate the state of a signal at the time it was read. Latched status bits—located in the SRLn registers—are set when a signal changes state (low-to-high, high-to-low, or both, depending on the bit) and cleared when written with a logic 1 value. After clearing, latched status bits remain cleared until the signal changes state again. Interrupt-enable bits—located in the SRIEn registers—control whether or not the \overline{INT} pin is driven low when latched register bits are set.

Figure 5-1. Status Register Logic

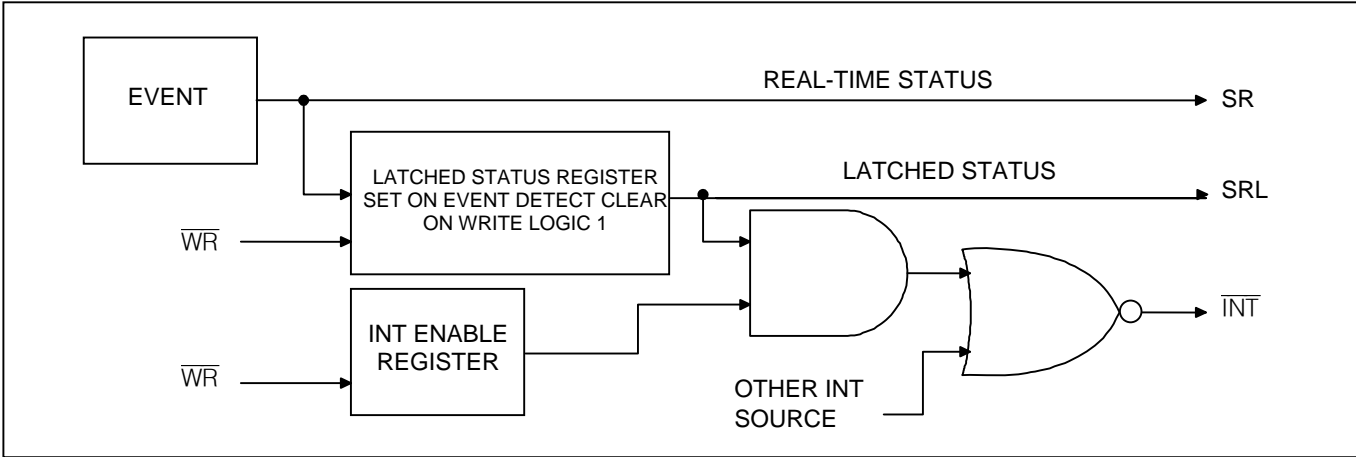

Register Name: **GCRn**
 Register Description: **Global Configuration Register**
 Register Address: **00h, 10h, 20h, 30h**

| Bit | 7 | 6 | 5 | 4 | 3 | 2 | 1 | 0 |
|---------|-----|-----|-----|-----|------|------|---|-----|
| Name | E3M | STS | LLB | RLB | TDSA | TDSB | — | RST |
| Default | 0 | 0 | 0 | 0 | 0 | 0 | — | 0 |

Bit 7: E3 Mode Enable (E3M)
 0 = DS3 operation
 1 = E3 or STS-1 operation

Bit 6: STS-1 Mode Enable (STS)
 When E3M = 1,
 0 = E3 operation
 1 = STS-1 operation
 When E3M = 0, STS selects the DS3 AIS pattern ([Table 4-F](#)).

Bits 5, 4: Local Loopback, Remote Loopback Select (LLB, RLB)
 00 = no loopback
 01 = remote loopback
 10 = analog local loopback
 11 = digital local loopback

Bits 3, 2: Transmitter Data Select (TDSA, TDSB). See [Table 4-F](#) for details.

Bit 0: Reset (RST). When this bit is high, the digital logic of the LIU is held in reset and all registers for that LIU (except the RST bit) are forced to their default values. RST is cleared to 0 at power-up and when the \overline{RST} pin is activated.
 0 = normal operation
 1 = reset LIU

Register Name: **TCRn**
 Register Description: **Transmitter Configuration Register**
 Register Address: **01h, 11h, 21h, 31h**

| Bit | 7 | 6 | 5 | 4 | 3 | 2 | 1 | 0 |
|---------|---|------|-------|-----|-----|-----|------|---|
| Name | — | TBIN | TCINV | TJA | TPD | TTS | TLBO | — |
| Default | 0 | 0 | 0 | 0 | 0 | 1 | 0 | — |

Bit 6: Transmitter Binary Interface Enable (TBIN)

0 = Transmitter framer interface is bipolar on the TPOS and TNEG pins. The B3ZS/HDB3 encoder is disabled.

1 = Transmitter framer interface is binary on the TDAT pin. The B3ZS/HDB3 encoder is enabled.

Bit 5: Transmitter Clock Invert (TCINV)

0 = TPOS/TDAT and TNEG are sampled on the rising edge of TCLK.

1 = TPOS/TDAT and TNEG are sampled on the falling edge of TCLK.

Bit 4: Transmitter Jitter Attenuator Enable (TJA)

0 = Remove jitter attenuator from the transmitter path.

1 = Insert jitter attenuator into the transmitter path.

Bit 3: Transmitter Power-Down Enable (TPD)

0 = enable the transmitter

1 = power-down the transmitter (output driver tri-stated)

Bit 2: Transmitter Tri-State Enable (TTS). This bit is set to 1 on reset, which tri-states the transmitter TXP and TXN pins. The transmitter circuitry is left powered up in this mode. The \overline{TTS} input pin is inverted and logically ORed with this bit.

0 = enable the transmitter output driver

1 = tri-state the transmitter output driver

Bit 1: Transmitter Line Build-Out (TLBO). TLBO indicates cable length for waveform shaping in DS3 and STS-1 modes. TLBO is ignored in E3 mode.

0 = cable length \geq 225ft

1 = cable length $<$ 225ft

Register Name: **RCRn**
 Register Description: **Receiver Configuration Register**
 Register Address: **02h, 12h, 22h, 32h**

| Bit | 7 | 6 | 5 | 4 | 3 | 2 | 1 | 0 |
|---------|-----|------|-------|-----|-----|-----|------|-------|
| Name | ITU | RBIN | RCINV | RJA | RPD | RTS | RMON | RCVUD |
| Default | 0 | 0 | 0 | 0 | 0 | 1 | 0 | 0 |

Bit 7: ITU CV Mode (ITU). This bit controls what types of bipolar violations (BPVs) are flagged as code violations on the RLCV pin and counted in the RCV register. It also controls whether or not excessive zero (EXZ) events are flagged and counted. An EXZ event is the occurrence of a third consecutive zero (DS3 or STS-1 modes) or fourth consecutive zero (E3 mode) in a sequence of zeros.

- 0 = In all three modes (DS3, E3, and STS-1) BPVs that are not part of a valid codeword are flagged and counted. EXZ events are also flagged and counted.
- 1 = In DS3 and STS-1 modes, BPVs that are not part of valid codewords are flagged and counted. In E3 mode, BPVs that are the same polarity as the last BPV are flagged and counted. EXZ events are not flagged and counted in any mode.

Bit 6: Receiver Binary Interface Enable (RBIN)

- 0 = Receiver framer interface is bipolar on the RPOS and RNEG pins. The B3ZS/HDB3 decoder is disabled.
- 1 = Receiver framer interface is binary on the RDAT pin with the RLCV pin indicating line-code violations. The B3ZS/HDB3 encoder is enabled.

Bit 5: Receiver Clock Invert (RCINV)

- 0 = RPOS/RDAT and RNEG/RLCV are sampled on the falling edge of RCLK.
- 1 = RPOS/RDAT and RNEG/RLCV are sampled on the rising edge of RCLK.

Bit 4: Receiver Jitter Attenuator Enable (RJA). (Note that TJA = 1 takes precedence over RJA = 1.)

- 0 = remove jitter attenuator from the receiver path
- 1 = insert jitter attenuator into the receiver path

Bit 3: Receiver Power-Down Enable (RPD)

- 0 = enable the receiver
- 1 = power-down the receiver (RPOS/RDAT, RNEG/RLCV, and RCLK tri-stated)

Bit 2: Receiver Tri-State Enable (RTS). This signal is set to 1 on reset, which tri-states the receiver RPOS/RDAT, RNEG/RLCV, and RCLK pins. The receiver is left powered up in this mode. The $\overline{\text{RTS}}$ pin is inverted and logically ORed with this bit.

- 0 = enable the receiver outputs
- 1 = tri-state the receiver outputs (RPOS/RDAT, RNEG/RLCV, and RCLK)

Bit 1: Receiver Monitor Preamp Enable (RMON)

- 0 = disable the monitor preamp
- 1 = enable the monitor preamp

Bit 0: Receive Code-Violation Counter Update (RCVUD). When this control bit transitions from low to high, the RCVLn and RCVHn registers are loaded with the current code-violation count, and the internal code-violation counter is cleared.

- 0→1 = Update RCV registers and clear internal code-violation counter

Register Name: **SRn**
 Register Description: **Status Register**
 Register Address: **03h, 13h, 23h, 33h**

| Bit | 7 | 6 | 5 | 4 | 3 | 2 | 1 | 0 |
|---------|---|---|------------|-------------|---|---|-------------|-------------|
| Name | — | — | <u>TDM</u> | <u>PRBS</u> | — | — | <u>RLOL</u> | <u>RLOS</u> |
| Default | — | — | 0 | 0 | — | — | 1 | 1 |

Bit 5: Transmitter Driver Monitor (TDM). This read-only status bit indicates the current state of the transmit driver monitor.

- 0 = the transmitter is operating normally
- 1 = the transmitter has a fault condition

Bit 4: PRBS Detector Output (PRBS). This read-only status bit indicates the current state of the receiver's PRBS detector. See [Table 4-G](#) for the expected PRBS pattern.

- 0 = in sync with expected pattern
- 1 = out of sync, expected pattern not detected

Bit 1: Receiver Loss of Lock (RLOL). This read-only status bit indicates the current state of the receiver clock recovery PLL.

- 0 = the receiver PLL is locked onto the incoming signal
- 1 = the receiver PLL is not locked onto the incoming signal

Bit 0: Receiver Loss of Signal (RLOS). This read-only status bit indicates the current state of the receiver loss-of-signal detector.

- 0 = signal present
- 1 = loss of signal

Register Name: **SRLn**
 Register Description: **Status Register Latched**
 Register Address: **04h, 14h, 24h, 34h**

| Bit | 7 | 6 | 5 | 4 | 3 | 2 | 1 | 0 |
|---------|---|---|------|-------|-------|------|-------|-------|
| Name | — | — | TDML | PRBSL | PBERL | RCVL | RLOLL | RLOSL |
| Default | — | — | 0 | 0 | 0 | 0 | 0 | 0 |

Bit 5: Transmitter Driver Monitor Latched (TDML). This latched status bit is set to one when the TDM status bit changes state (low to high or high to low). TDML is cleared when the host processor writes a one to it and is not set again until TDM changes state again. When TDML is set, it can cause a hardware interrupt to occur if the TDMIE interrupt-enable bit is set to one. The interrupt is cleared when TDML is cleared or TDMIE is set to zero.

Bit 4: PRBS Detector Output Latched (PRBSL). This latched status bit is set to one when the PRBS status bit changes state (low to high or high to low). PRBSL is cleared when the host processor writes a one to it and is not set again until PRBS changes state again. When PRBSL is set, it can cause a hardware interrupt to occur if the PRBSIE interrupt-enable bit is set to one. The interrupt is cleared when PRBSL is cleared or PRBSIE is set to zero.

Bit 3: PRBS Detector Bit Error Latched (PBERL). This latched status bit is set to one when the PRBS detector is in sync and a bit error has been detected. PBERL is cleared when the host processor writes a one to it and is not set again until another bit error is detected. When PBERL is set, it can cause a hardware interrupt to occur if the PBERIE interrupt-enable bit is set to one. The interrupt is cleared when PBERL is cleared or PBERIE is set to zero.

Bit 2: Receiver Code Violation Latched (RCVL). This latched status bit is set to one when the RCV status bit goes high. RCVL is cleared when the host processor writes a one to it and is not set again until RCV goes high again. When RCVL is set, it can cause a hardware interrupt to occur if the RCVIE interrupt-enable bit is set to one. The interrupt is cleared when RCVL is cleared or RCVIE is set to zero.

Bit 1: Receiver Loss-of-Clock Lock Latched (RLOLL). This latched status bit is set to one when the RLOL status bit changes state (low to high or high to low). RLOLL is cleared when the host processor writes a one to it and is not set again until RLOL changes state again. When RLOLL is set, it can cause a hardware interrupt to occur if the RLOLIE interrupt-enable bit is set to one. The interrupt is cleared when RLOLL is cleared or RLOLIE is set to zero.

Bit 0: Receiver Loss-of-Signal Latched (RLOSL). This latched status bit is set to one when the RLOS status bit changes state (low to high or high to low). RLOSL is cleared when the host processor writes a one to it and is not set again until RLOS changes state again. When RLOSL is set, it can cause a hardware interrupt to occur if the RLOSIE interrupt-enable bit is set to one. The interrupt is cleared when RLOSL is cleared or RLOSIE is set to zero.

Register Name: **SRIEn**
 Register Description: **Status Register Interrupt Enable**
 Register Address: **05h, 15h, 25h, 35h**

| Bit | 7 | 6 | 5 | 4 | 3 | 2 | 1 | 0 |
|---------|---|---|-------|--------|--------|-------|--------|--------|
| Name | — | — | TDMIE | PRBSIE | PBERIE | RCVIE | RLOLIE | RLOSIE |
| Default | — | — | 0 | 0 | 0 | 0 | 0 | 0 |

Bit 5: Transmitter Driver Monitor Interrupt Enable (TDMIE)

0 = mask TDML interrupt
 1 = enable TDML interrupt

Bit 4: PRBS Detector Interrupt Enable (PRBSIE)

0 = mask PRBSL interrupt
 1 = enable PRBSL interrupt

Bit 3: PRBS Detector Bit-Error Interrupt Enable (PBERIE)

0 = mask PBERL interrupt
 1 = enable PBERL interrupt

Bit 2: Receiver Line-Code Violation Interrupt Enable (RCVIE)

0 = mask RCVL interrupt
 1 = enable RCVL interrupt

Bit 1: Receiver Loss-of-Clock Lock Interrupt Enable (RLOLIE)

0 = mask RLOLL interrupt
 1 = enable RLOLL interrupt

Bit 0: Receiver Loss-of-Signal Interrupt Enable (RLOSIE)

0 = mask RLOSL interrupt
 1 = enable RLOSL interrupt

Register Name: **RCVLn**
 Register Description: **Receiver Code-Violation Count Register (Low Byte)**
 Register Address: **06h, 16h, 26h, 36h**

| Bit | 7 | 6 | 5 | 4 | 3 | 2 | 1 | 0 |
|---------|--------|--------|--------|--------|--------|--------|--------|--------|
| Name | RCV[7] | RCV[6] | RCV[5] | RCV[4] | RCV[3] | RCV[2] | RCV[1] | RCV[0] |
| Default | 0 | 0 | 0 | 0 | 0 | 0 | 0 | 0 |

Register Name: **RCVHn**
 Register Description: **Receiver Code-Violation Count Register (High Byte)**
 Register Address: **07h, 17h, 27h, 37h**

| Bit | 7 | 6 | 5 | 4 | 3 | 2 | 1 | 0 |
|---------|---------|---------|---------|---------|---------|---------|--------|--------|
| Name | RCV[15] | RCV[14] | RCV[13] | RCV[12] | RCV[11] | RCV[10] | RCV[9] | RCV[8] |
| Default | 0 | 0 | 0 | 0 | 0 | 0 | 0 | 0 |

Bits 15 to 0: Receiver Code-Violation Counter Register (RCV[15:0]). The RCV registers form a 16-bit register for reading the line-code violation counter value. The registers are updated with the line-code violation counter value when the RCVUD control bit is toggled low to high. After the RCV registers are updated, the line-code violation counter is cleared. The counter operates in two modes, depending on the setting of the ITU bit in the RCR register. See the RCR register description for details about the ITU control bit.

6. RECEIVER

Interfacing to the Line. The receiver can be transformer-coupled or capacitor-coupled to the line. Typically, the receiver interfaces to the incoming coaxial cable (75Ω) through a 1:2 step-up transformer. [Figure 1-1](#) shows the arrangement of the transformer and other recommended interface components. [Table 11-A](#) specifies the required characteristics of the transformer. The receiver expects the incoming signal to be in B3ZS- or HDB3-coded AMI format.

Optional Preamp. The receiver can be used in monitoring applications, which typically have series resistors with a resistive loss of approximately 20dB. When the RMON input pin is high, the receiver compensates for this resistive loss by applying approximately 14dB of flat gain to the incoming signal before sending the signal to the AGC/equalizer block where additional flat gain is applied as needed.

Automatic Gain Control (AGC) and Adaptive Equalizer. The AGC circuitry applies flat (frequency independent) gain to the incoming signal to compensate for flat losses in the transmission channel and variations in transmission power. Since the incoming signal also experiences frequency-dependent losses as it passes through the coaxial cable, the adaptive equalizer circuitry applies frequency-dependent gain to offset line losses and restore the signal. The AGC/equalizer circuitry automatically adapts to coaxial cable losses from 0 to 15dB, which translates into 0 to 380 meters (DS3), 0 to 440 meters (E3), or 0 to 360 meters (STS-1) of coaxial cable (AT&T 734A or equivalent). The AGC and the equalizer work simultaneously but independently to supply a signal of nominal amplitude and pulse shape to the clock and data recovery block. The AGC/equalizer block automatically handles direct (0 meters) monitoring of the transmitter output signal.

Clock and Data Recovery (CDR). The CDR block takes the amplified, equalized signal from the AGC/equalizer block and produces separate clock, positive data, and negative data signals. The CDR requires a master clock. If the signal on the appropriate MCLK pin is toggling, the LIU selects the MCLK signal as its master clock. If the appropriate MCLK pin is wired high, the LIU uses the signal on the TCLK pin as the master clock. The appropriate MCLK is selected based on the settings of the E3M and STS mode pins or register bits.

The receiver locks onto the incoming signal using a clock recovery PLL. The status of the PLL lock is indicated in the RLOL status bit. The RLOL bit is set when the difference between recovered clock frequency and MCLK frequency is greater than 7900ppm and cleared when the difference is less than 7700ppm. A change of state of the RLOL status bit can cause an interrupt on the $\overline{\text{INT}}$ pin if enabled to do so by the RLOLIE interrupt-enable bit. Note that if MCLK is not present, or MCLK is high and TCLK is not present, RLOL is not set.

Loss-of-Signal (LOS) Detector. The receiver contains analog and digital LOS detectors. The analog LOS detector resides in the AGC/equalizer block. If the incoming signal level is less than a signal level approximately 24dB below nominal, analog LOS (ALOS) is declared. The ALOS signal cannot be directly examined, but when ALOS occurs the AGC/equalizer mutes the recovered data, forcing all zeros out of the data recovery circuitry and causing digital LOS (DLOS), which is indicated by the $\overline{\text{RLOS}}$ pin and the RLOS status bit. ALOS clears when the incoming signal level is greater than or equal to a signal level approximately 18dB below nominal.

The digital LOS detector declares DLOS when it detects 175 ± 75 consecutive zeros in the recovered data stream. When DLOS occurs, the receiver asserts the $\overline{\text{RLOS}}$ pin (hardware mode) or the RLOS status bit (CPU bus mode). DLOS is cleared when there are no EXZ occurrences over a span of 175 ± 75 clock periods. An EXZ occurrence is defined as three or more consecutive zeros in the DS3 and STS-1 modes and four or more consecutive zeros in the E3 mode. The $\overline{\text{RLOS}}$ pin goes inactive (high) when the DLOS condition is cleared. In CPU bus mode, a change of the RLOS status bit can cause an interrupt on the $\overline{\text{INT}}$ pin if enabled to do so by the RLOSIE interrupt-enable bit.

The requirements of ANSI T1.231 and ITU-T G.775 for DS3 LOS defects are met by the DLOS detector, which asserts RLOS when it counts 175 ± 75 consecutive zeros coming out of the CDR block and clears RLOS when it counts 175 ± 75 consecutive pulse intervals without excessive zero occurrences.

The requirements of ITU-T G.775 for E3 LOS defects are met by a combination of the ALOS detector and the DLOS detector, as follows:

For E3 RLOS Assertion:

- 1) The ALOS detector in the AGC/equalizer block detects that the incoming signal is less than or equal to a signal level approximately 24dB below nominal, and mutes the data coming out of the clock and data recovery block. (24dB below nominal in the “tolerance range” of G.775, where LOS may or may not be declared.)
- 2) The DLOS detector counts 175 ± 75 consecutive zeros coming out of the CDR block and asserts RLOS. (175 ± 75 meets the $10 \leq N \leq 255$ pulse-interval duration requirement of G.775.)

For E3 RLOS Clear:

- 1) The ALOS detector in the AGC/equalizer block detects that the incoming signal is greater than or equal to a signal level approximately 18dB below nominal, and enables data to come out of the CDR block. (18dB is in the “tolerance range” of G.775, where LOS may or may not be declared.)
- 2) The DLOS detector counts 175 ± 75 consecutive pulse intervals without EXZ occurrences and deasserts RLOS. (175 ± 75 meets the $10 \leq N \leq 255$ pulse-interval duration requirement of G.775.)

The DLOS detector supports the requirements of ANSI T1.231 for STS-1 LOS defects. At STS-1 rates, the time required for the DLOS detector to count 175 ± 75 consecutive zeros falls in the range of $2.3 \leq T \leq 100 \mu\text{s}$ required by ANSI T1.231 for declaring an LOS defect. Although the time required for the DLOS detector to count 175 ± 75 consecutive pulse intervals with no excessive zeros is less than the $125 \mu\text{s}$ – $250 \mu\text{s}$ period required by ANSI T1.231 for clearing an LOS defect, a period of this length where LOS is inactive can easily be timed in software.

During LOS, the RCLK output pin is derived from the LIU’s master clock. The ALOS detector has a longer time constant than the DLOS detector. Thus, when the incoming signal is lost, the DLOS detector activates first (asserting the RLOS pin or bit), followed by the ALOS detector. When a signal is restored, the DLOS detector does not get a valid signal that it can qualify for no EXZ occurrences until the ALOS detector has seen the signal rise above a signal level approximately 18dB below nominal.

Framer Interface Format and the B3ZS/HDB3 Decoder. The recovered data can be output in either binary or bipolar format. To select the bipolar interface format, pull the RBIN pin low (hardware mode) or clear the RBIN configuration bit (CPU bus mode). In bipolar format, the B3ZS/HDB3 decoder is disabled and the recovered data is buffered and output on the RPOS and RNEG outputs. Received positive-polarity pulses are indicated by RPOS = 1, while negative-polarity pulses are indicated by RNEG = 1. In bipolar interface format, the receiver simply passes on the received data and does not check it for BPV or EXZ occurrences.

To select the binary interface format, pull the RBIN pin high (hardware mode) or set the RBIN configuration bit (CPU bus mode). In binary format, the B3ZS/HDB3 decoder is enabled, and the recovered data is decoded and output as a binary value on the RDAT pin. Code violations are flagged on the RLCV pin. In the discussion that follows, a valid pulse that conforms to the AMI rule is denoted as B. A BPV pulse that violates the AMI rule is denoted as V.

In DS3 and STS-1 modes, B3ZS decoding is performed. RLCV is asserted during any RCLK cycle where the data on RDAT causes ones of the following code violations:

- Hardware mode or ITU bit set to 0
 - A BPV immediately preceded by a valid pulse (B, V).
 - A BPV with the same polarity as the last BPV.
 - The third zero in an EXZ occurrence.
- ITU bit set to 1
 - A BPV immediately preceded by a valid pulse (B, V).
 - A BPV with the same polarity as the last BPV.

In E3 mode, HDB3 decoding is performed. RLCV is asserted during any RCLK cycle where the data on RDAT causes one of the following code violations:

- Hardware mode or ITU bit set to 0
 - A BPV immediately preceded by a valid pulse (B, V) or by a valid pulse and a zero (B, 0, V).
 - A BPV with the same polarity as the last BPV.
 - The fourth zero in an EXZ occurrence (only in hardware mode or when ITU = 0).

- ITU bit set to 1
 - A BPV with the same polarity as the last BPV.

When RLCV is asserted to flag a BPV, the RDAT pin outputs a one. The state bit that tracks the polarity of the last BPV is toggled on every BPV, whether part of a valid B3ZS/HDB3 codeword or not.

To support a glueless interface to a variety of neighboring components, the polarity of RCLK can be inverted. Normally, data is output on the RPOS/RDAT and RNEG/RLCV pins on the falling edge of RCLK. To output data on these pins on the rising edge of RCLK, pull the RCINV pin high (hardware mode) or set the RCINV configuration bit (CPU bus mode).

The RCLK, RPOS/RDAT, and RNEG/RLCV pins can be tri-stated to support protection switching and redundant-LIU applications. This tri-stating capability supports system configurations where two or more LIUs are wire-ORed together and a system processor selects one to be active. To tri-state RCLK, RPOS/RDAT, and RNEG/RLCV, assert the RTS pin or the RTS configuration bit.

Receive Line-Code Violation Counter. The line-code violation counter is always enabled regardless of the settings of the RBIN pin or the RBIN configuration bit. The receiver has an internal 16-bit saturating counter and a 16-bit latch, which the CPU can read as registers RCVH and RCVL. The value of the internal counter is latched into the RCVH/RCVL register and cleared when the receive code-violation counter update bit, RCVUD, is changed from a zero to a one. The RCVUD bit must be cleared back to a zero before a new update can occur. If there is an LCV increment pulse and an update pulse in the same clock period, the counter is preset to a one rather than cleared so that the LCV is not missed. The counter is incremented when the RLCV pin flags a code violation as described in the *Framer Interface Format and the B3ZS/HDB3 Decoder* section. The counter saturates at 65,535 (0FFFFh) and does not roll over.

Receiver Power-Down. To minimize power consumption when the receiver is not being used, assert the RPD configuration bit (CPU bus mode). When the receiver is powered down, the RCLK, RPOS/RDAT, and RNEG/RLCV pins are tri-stated. In addition, the RXP and RXN pins become high impedance.

Receiver Jitter Tolerance. The receiver exceeds the input jitter tolerance requirements of all applicable telecommunication standards in [Table 1-A](#). See [Figure 6-1](#).

Figure 6-1. Receiver Jitter Tolerance

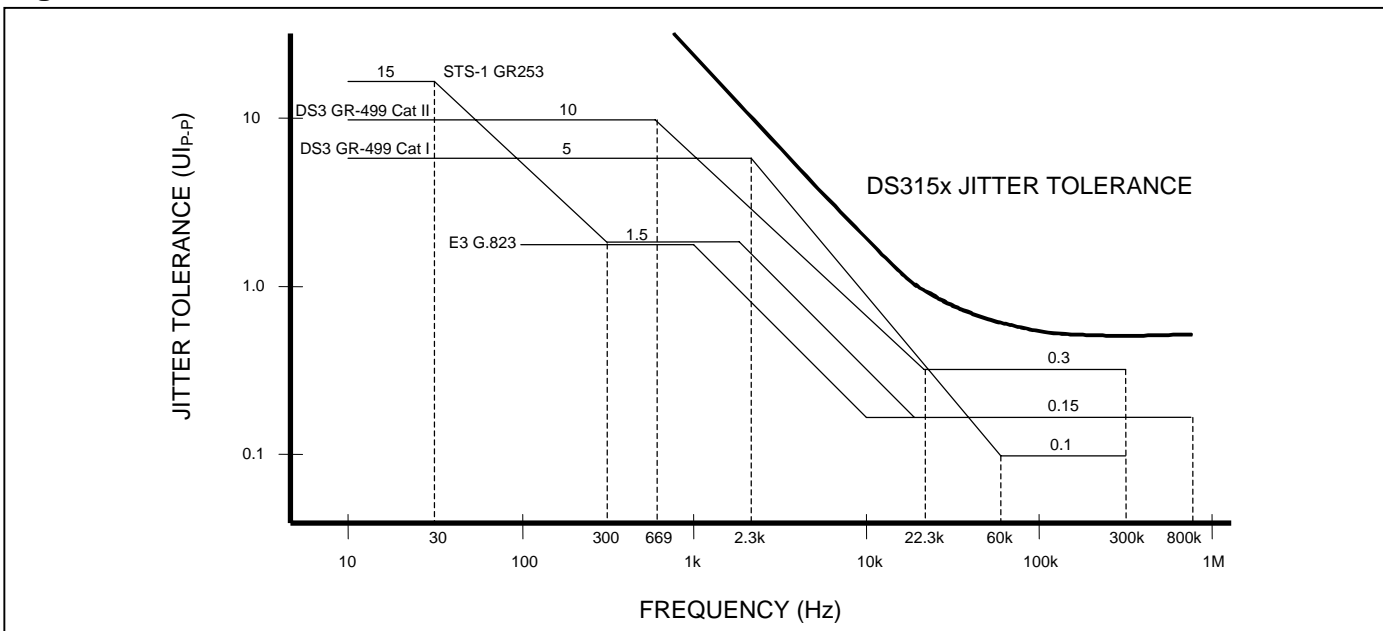

7. TRANSMITTER

Transmit Clock. The clock applied at the TCLK input clocks in data on the TPOS/TDAT and TNEG pins. If the jitter attenuator is not enabled in the transmit path, the signal on TCLK is the transmit line clock and must be transmission quality (i.e., ± 20 ppm frequency accuracy and low jitter). If the jitter attenuator is enabled in the transmit path, the signal on TCLK can be jittery and/or periodically gapped (not exceeding 8UI), but must still have an average frequency within ± 20 ppm of the nominal line rate. When enabled in the transmit path, the jitter attenuator generates the transmit line clock from the signal applied on the appropriate MCLK pin. The signal on the MCLK pin must, therefore, be a transmission-quality clock (± 20 ppm frequency accuracy and low jitter).

The polarity of TCLK can be inverted to support glueless interfacing to a variety of neighboring components. Normally data is sampled on the TPOS/TDAT and TNEG pins on the rising edge of TCLK. To sample data on the falling edge of TCLK, pull the TCINV pin high (hardware mode) or set the TCINV configuration bit (CPU bus mode).

Framer Interface Format and the B3ZS/HDB3 Encoder. Data to be transmitted can be input in either binary or bipolar format. To select the binary interface format, pull the TBIN pin high (hardware mode) or set the TBIN configuration bit (CPU bus mode). In binary format, the B3ZS/HDB3 encoder is enabled, and the data to be transmitted is sampled on the TDAT pin. The TNEG pin is ignored in binary interface mode and should be wired low. In DS3 and STS-1 modes, the B3ZS/HDB3 encoder operates in the B3ZS mode. In E3 mode the encoder operates in HDB3 mode.

To select the bipolar interface format, pull the TBIN pin low (hardware mode) or clear the TBIN configuration bit (CPU bus mode). In bipolar format, the B3ZS/HDB3 encoder is disabled and the data to be transmitted is sampled on the TPOS and TNEG pins. Positive-polarity pulses are indicated by TPOS = 1, while negative-polarity pulses are indicated by TNEG = 1.

Pattern Generation. The transmitter can generate several patterns internally, including unframed all ones (E3 AIS), 100100..., and DS3 AIS. See [Figure 7-2](#) for the structure of the DS3 AIS signal. The TDSA and TDSB input pins (hardware mode) or the TDSA and TDSB control bits (CPU bus mode) are used to select these patterns. [Table 4-F](#) indicates the possible selections.

Waveshaping, Line Build-Out, Line Driver. The waveshaping block converts the transmit clock, positive data, and negative data signals into a single AML signal with the waveshape required for interfacing to DS3/E3/STS-1 lines. [Table 7-A](#) through [Table 7-E](#) and [Figure 7-1](#) show the waveform template specifications and test parameters.

Because DS3 and STS-1 signals must meet the waveform templates at the cross-connect through any cable length from 0 to 450ft, the waveshaping circuitry includes a selectable LBO feature. For cable lengths of 225ft or greater, the TLBO pin (hardware mode) or the TLBO configuration bit (CPU bus mode) should be low. When TLBO is low, output pulses are driven onto the coaxial cable without any preattenuation. For cable lengths less than 225ft, TLBO should be high to enable the LBO circuitry. When TLBO is high, pulses are preattenuated by the LBO circuitry before being driven onto the coaxial cable. The LBO circuitry provides attenuation that mimics the attenuation of 225ft of coaxial cable.

The transmitter line driver can be disabled and the TXP and TXN outputs tri-stated by asserting the $\overline{\text{TTS}}$ input or the TTS configuration bit. Powering down the transmitter through the TPD configuration bit (CPU bus mode) also tri-states the TXP and TXN outputs.

Interfacing to the Line. The transmitter interfaces to the outgoing DS3/E3/STS-1 coaxial cable (75Ω) through a 2:1 step-down transformer connected to the TXP and TXN pins. [Figure 1-1](#) shows the arrangement of the transformer and other recommended interface components. [Table 11-A](#) specifies the required characteristics of the transformer.

Transmit Driver Monitor. If the transmit driver monitor detects a faulty transmitter, it activates the $\overline{\text{TDM}}$ output (hardware mode or CPU bus mode) or sets the TDM status bit and optionally activates the $\overline{\text{INT}}$ output (CPU bus mode). When the transmitter is tri-stated, the transmit driver monitor is also disabled. The transmitter is declared to be faulty when the transmitter outputs see a load of less than $\sim 25\Omega$.

Transmitter Power-Down. To minimize power consumption when the transmitter is not being used, assert the TPD configuration bit (CPU bus mode only). When the transmitter is powered down, the TXP and TXN pins are put in a high-impedance state and the transmit amplifiers are powered down.

Transmitter Jitter Generation (Intrinsic). The transmitter meets the jitter generation requirements of all applicable standards, with or without the jitter attenuator enabled.

Transmitter Jitter Transfer. Without the jitter attenuator enabled in the transmit side, the transmitter passes jitter through unchanged. With the jitter attenuator enabled in the transmit side, the transmitter meets the jitter transfer requirements of all applicable telecommunication standards in [Table 1-A](#). See [Figure 9-1](#).

Table 7-A. DS3 Waveform Template

| TIME (IN UNIT INTERVALS) | NORMALIZED AMPLITUDE EQUATION |
|---------------------------|--|
| UPPER CURVE | |
| $-0.85 \leq T \leq -0.68$ | 0.03 |
| $-0.68 \leq T \leq +0.36$ | $0.5 \{1 + \sin[(\pi / 2)(1 + T / 0.34)]\} + 0.03$ |
| $0.36 \leq T \leq 1.4$ | $0.08 + 0.407e^{-1.84(T - 0.36)}$ |
| LOWER CURVE | |
| $-0.85 \leq T \leq -0.36$ | -0.03 |
| $-0.36 \leq T \leq +0.36$ | $0.5 \{1 + \sin[(\pi / 2)(1 + T / 0.18)]\} - 0.03$ |
| $0.36 \leq T \leq 1.4$ | -0.03 |

Governing Specifications: ANSI T1.102 and Bellcore GR-499.

Table 7-B. DS3 Waveform Test Parameters and Limits

| PARAMETER | SPECIFICATION |
|--|---|
| Rate | 44.736Mbps (± 20 ppm) |
| Line Code | B3ZS |
| Transmission Medium | Coaxial cable (AT&T 734A or equivalent) |
| Test Measurement Point | At the end of 0 to 450ft of coaxial cable |
| Test Termination | 75 Ω ($\pm 1\%$) resistive |
| Pulse Amplitude | Between 0.36V and 0.85V |
| Pulse Shape | An isolated pulse (preceded by two zeros and followed by one or more zeros) falls within the curves listed in Table 7-A . |
| Unframed All-Ones Power Level at 22.368MHz | Between -1.8dBm and +5.7dBm |
| Unframed All-Ones Power Level at 44.736MHz | At least 20dB less than the power measured at 22.368MHz |
| Pulse Imbalance of Isolated Pulses | Ratio of positive and negative pulses must be between 0.90 and 1.10. |

Table 7-C. STS-1 Waveform Template

| TIME (IN UNIT INTERVALS) | NORMALIZED AMPLITUDE EQUATIONS |
|---------------------------|--|
| UPPER CURVE | |
| $-0.85 \leq T \leq -0.68$ | 0.03 |
| $-0.68 \leq T \leq +0.26$ | $0.5 \{1 + \sin[(\pi / 2)(1 + T / 0.34)]\} + 0.03$ |
| $0.26 \leq T \leq 1.4$ | $0.1 + 0.61e^{-2.4(T - 0.26)}$ |
| LOWER CURVE | |
| $-0.85 \leq T \leq -0.36$ | -0.03 |
| $-0.36 \leq T \leq +0.36$ | $0.5 \{1 + \sin[(\pi / 2)(1 + T / 0.18)]\} - 0.03$ |
| $0.36 \leq T \leq 1.4$ | -0.03 |

Governing Specifications: Bellcore GR-253 and Bellcore GR-499 and ANSI T1.102.

Table 7-D. STS-1 Waveform Test Parameters and Limits

| PARAMETER | SPECIFICATION |
|---|---|
| Rate | 51.840Mbps (± 20 ppm) |
| Line Code | B3ZS |
| Transmission Medium | Coaxial cable (AT&T 734A or equivalent) |
| Test Measurement Point | At the end of 0 to 450ft of coaxial cable |
| Test Termination | 75 Ω ($\pm 1\%$) resistive |
| Pulse Amplitude | 0.800V nominal (not covered in specs) |
| Pulse Shape | An isolated pulse (preceded by two zeros and followed by one or more zeros) falls within the curved listed in Table 7-C . |
| Unframed All-Ones Power Level at 25.92MHz | Between -1.8dBm and +5.7dBm |
| Unframed All-Ones Power Level at 51.84MHz | At least 20dB less than the power measured at 25.92MHz. |

Table 7-E. E3 Waveform Test Parameters and Limits

| PARAMETER | SPECIFICATION |
|---|---|
| Rate | 34.368Mbps (± 20 ppm) |
| Line Code | HDB3 |
| Transmission Medium | Coaxial cable (AT&T 734A or equivalent) |
| Test Measurement Point | At the transmitter |
| Test Termination | 75 Ω ($\pm 1\%$) resistive |
| Pulse Amplitude | 1.0V (nominal) |
| Pulse Shape | An isolated pulse (preceded by two zeros and followed by one or more zeros) falls within the template shown in Figure 7-1 . |
| Ratio of the Amplitudes of Positive and Negative Pulses at the Center of the Pulse Interval | 0.95 to 1.05 |
| Ratio of the Widths of Positive and Negative Pulses at the Nominal Half Amplitude | 0.95 to 1.05 |

Figure 7-1. E3 Waveform Template

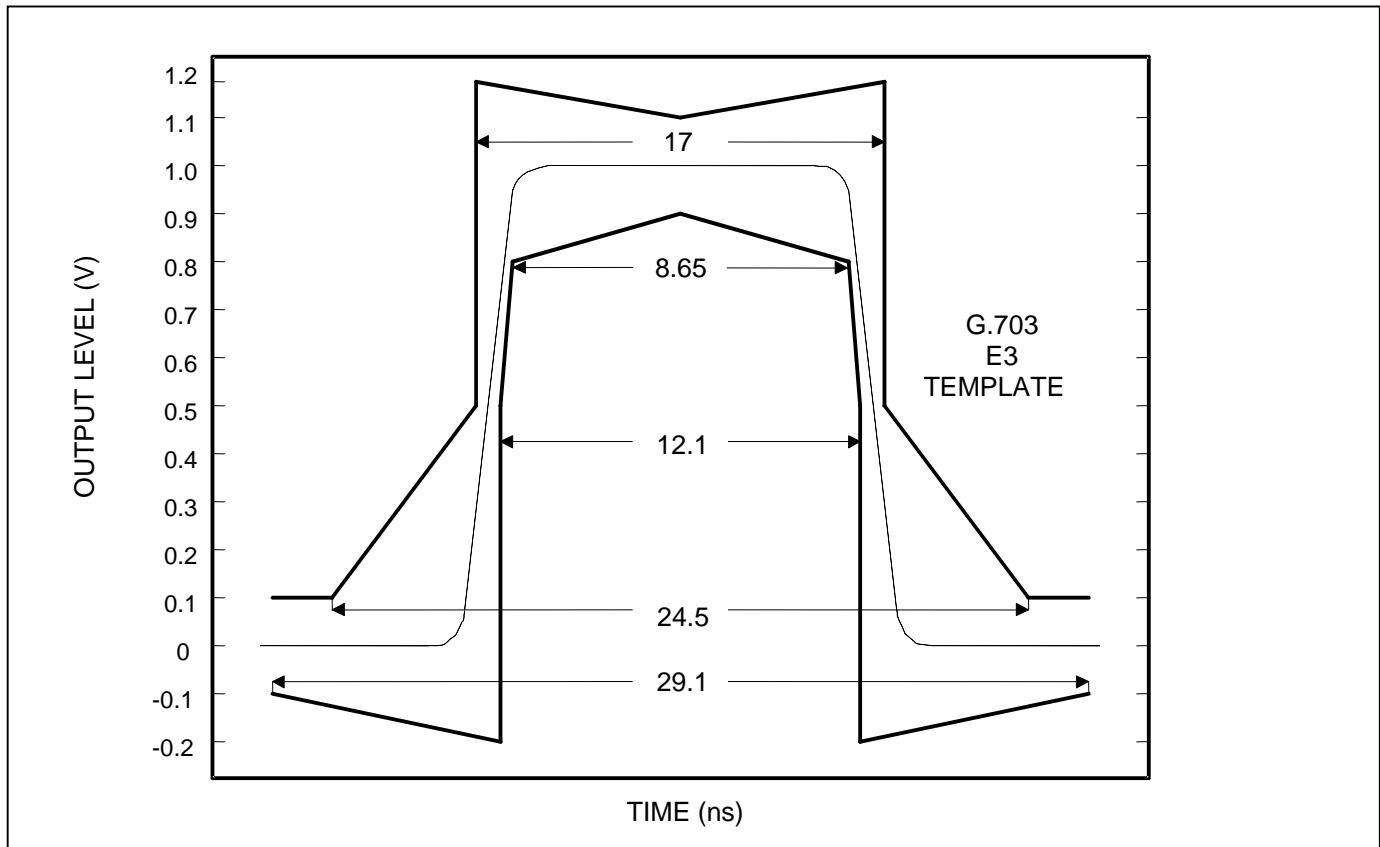

Figure 7-2. DS3 AIS Structure

M1 Subframe

| | | | | | | | | | | | | | | | |
|-----------|--------------------|-----------|--------------------|-----------|--------------------|-----------|--------------------|-----------|--------------------|-----------|--------------------|-----------|--------------------|-----------|--------------------|
| X1 (1) | 84 Info Bits | F1 (1) | 84 Info Bits | C1 (0) | 84 Info Bits | F2 (0) | 84 Info Bits | C2 (0) | 84 Info Bits | F3 (0) | 84 Info Bits | C3 (0) | 84 Info Bits | F4 (1) | 84 Info Bits |
|-----------|--------------------|-----------|--------------------|-----------|--------------------|-----------|--------------------|-----------|--------------------|-----------|--------------------|-----------|--------------------|-----------|--------------------|

M2 Subframe

| | | | | | | | | | | | | | | | |
|-----------|--------------------|-----------|--------------------|-----------|--------------------|-----------|--------------------|-----------|--------------------|-----------|--------------------|-----------|--------------------|-----------|--------------------|
| X2 (1) | 84 Info Bits | F1 (1) | 84 Info Bits | C1 (0) | 84 Info Bits | F2 (0) | 84 Info Bits | C2 (0) | 84 Info Bits | F3 (0) | 84 Info Bits | C3 (0) | 84 Info Bits | F4 (1) | 84 Info Bits |
|-----------|--------------------|-----------|--------------------|-----------|--------------------|-----------|--------------------|-----------|--------------------|-----------|--------------------|-----------|--------------------|-----------|--------------------|

M3 Subframe

| | | | | | | | | | | | | | | | |
|-----------|--------------------|-----------|--------------------|-----------|--------------------|-----------|--------------------|-----------|--------------------|-----------|--------------------|-----------|--------------------|-----------|--------------------|
| P1 (0) | 84 Info Bits | F1 (1) | 84 Info Bits | C1 (0) | 84 Info Bits | F2 (0) | 84 Info Bits | C2 (0) | 84 Info Bits | F3 (0) | 84 Info Bits | C3 (0) | 84 Info Bits | F4 (1) | 84 Info Bits |
|-----------|--------------------|-----------|--------------------|-----------|--------------------|-----------|--------------------|-----------|--------------------|-----------|--------------------|-----------|--------------------|-----------|--------------------|

M4 Subframe

| | | | | | | | | | | | | | | | |
|-----------|--------------------|-----------|--------------------|-----------|--------------------|-----------|--------------------|-----------|--------------------|-----------|--------------------|-----------|--------------------|-----------|--------------------|
| P2 (0) | 84 Info Bits | F1 (1) | 84 Info Bits | C1 (0) | 84 Info Bits | F2 (0) | 84 Info Bits | C2 (0) | 84 Info Bits | F3 (0) | 84 Info Bits | C3 (0) | 84 Info Bits | F4 (1) | 84 Info Bits |
|-----------|--------------------|-----------|--------------------|-----------|--------------------|-----------|--------------------|-----------|--------------------|-----------|--------------------|-----------|--------------------|-----------|--------------------|

M5 Subframe

| | | | | | | | | | | | | | | | |
|-----------|--------------------|-----------|--------------------|-----------|--------------------|-----------|--------------------|-----------|--------------------|-----------|--------------------|-----------|--------------------|-----------|--------------------|
| M1 (0) | 84 Info Bits | F1 (1) | 84 Info Bits | C1 (0) | 84 Info Bits | F2 (0) | 84 Info Bits | C2 (0) | 84 Info Bits | F3 (0) | 84 Info Bits | C3 (0) | 84 Info Bits | F4 (1) | 84 Info Bits |
|-----------|--------------------|-----------|--------------------|-----------|--------------------|-----------|--------------------|-----------|--------------------|-----------|--------------------|-----------|--------------------|-----------|--------------------|

M6 Subframe

| | | | | | | | | | | | | | | | |
|-----------|--------------------|-----------|--------------------|-----------|--------------------|-----------|--------------------|-----------|--------------------|-----------|--------------------|-----------|--------------------|-----------|--------------------|
| M2 (1) | 84 Info Bits | F1 (1) | 84 Info Bits | C1 (0) | 84 Info Bits | F2 (0) | 84 Info Bits | C2 (0) | 84 Info Bits | F3 (0) | 84 Info Bits | C3 (0) | 84 Info Bits | F4 (1) | 84 Info Bits |
|-----------|--------------------|-----------|--------------------|-----------|--------------------|-----------|--------------------|-----------|--------------------|-----------|--------------------|-----------|--------------------|-----------|--------------------|

M7 Subframe

| | | | | | | | | | | | | | | | |
|-----------|--------------------|-----------|--------------------|-----------|--------------------|-----------|--------------------|-----------|--------------------|-----------|--------------------|-----------|--------------------|-----------|--------------------|
| M3 (0) | 84 Info Bits | F1 (1) | 84 Info Bits | C1 (0) | 84 Info Bits | F2 (0) | 84 Info Bits | C2 (0) | 84 Info Bits | F3 (0) | 84 Info Bits | C3 (0) | 84 Info Bits | F4 (1) | 84 Info Bits |
|-----------|--------------------|-----------|--------------------|-----------|--------------------|-----------|--------------------|-----------|--------------------|-----------|--------------------|-----------|--------------------|-----------|--------------------|

Note 1: X1 is transmitted first.

Note 2: The 84 info bits contain the repetitive sequence 1010..., where the first 1 in the sequence immediately follows each X, P, F, C, or M bit.

8. DIAGNOSTICS

PRBS Generator and Detector. Each LIU has built-in pseudorandom bit sequence (PRBS) generator and detector circuitry for physical layer testing. The device generates and detects unframed $2^{15} - 1$ (DS3 or STS-1) or $2^{23} - 1$ PRBS, according to the ITU O.151 specification. To transmit a PRBS pattern, pull the TDSA and TDSB pins high (hardware mode) or set configuration bits TDSA and TDSB (CPU bus mode). As [Table 4-F](#) shows, the PRBS generator automatically generates $2^{15} - 1$ for DS3 and STS-1 modes and $2^{23} - 1$ for E3 mode.

The PRBS detector, which is always enabled ([Table 4-G](#)), reports its status through the PRBS output pin (hardware and CPU bus modes) or through the PRBS and PBER status bits (CPU bus mode). When the PRBS detector is out of synchronization, the PRBS pin is forced high. When the detector syncs to an incoming PRBS pattern, the PRBS pin is driven low, then pulses high, synchronous with RCLK, for each bit error detected. See [Figure 8-1](#) and [Figure 8-2](#) for details. In CPU bus mode, the PRBS status bit is set to one when the detector is out of synchronization and set to zero when the detector syncs to an incoming PRBS pattern. A change of state of the PRBS bit can cause an interrupt on the $\overline{\text{INT}}$ pin if the PRBSIE interrupt-enable bit is set to one. A pattern bit error can also cause an interrupt if the PBERIE interrupt-enable bit is set to one. The PRBS detector also declares sync in the presence of an incoming all-ones pattern.

Loopbacks. Each LIU has three internal loopbacks. See [Figure 3-1](#) and [Figure 3-2](#). The LLB and RLB pins (hardware mode) or LLB and RLB control bits (CPU bus mode) enable these loopbacks. When LLB = RLB = 0, loopbacks are disabled. Setting RLB = 1 with LLB = 0 enables remote loopback, which loops recovered clock and data back through the LIU transmitter. During remote loopback, recovered clock and data are output on RCLK, RPOS/RDAT, and RNEG/RLCV, but the TPOS/TDAT and TNEG pins are ignored. Setting LLB = 1 with RLB = 0 enables analog local loopback, which loops the outgoing transmit signal back to the receiver’s analog front end. Setting LLB = RLB = 1 enables digital local loopback, which loops digital transmit clock and data back to the receiver’s digital circuitry, including the LOS detector, the B3ZS/HDB3 decoder, and the PRBS detector. When either of the local loopbacks is enabled, the transmit signal is output normally on TXP/TXN, but the received signal on RXP/RXN is ignored.

Figure 8-1. PRBS Output with Normal RCLK Operation

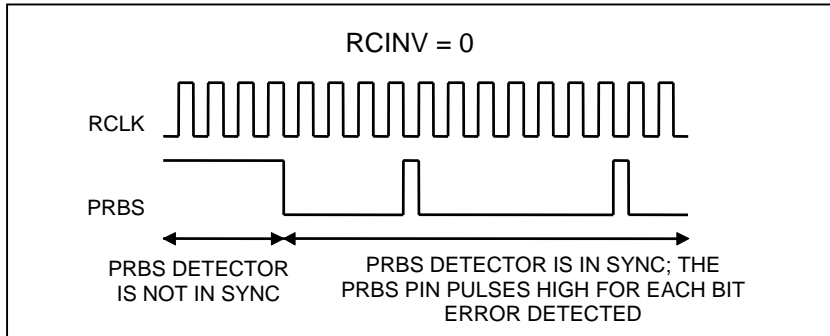
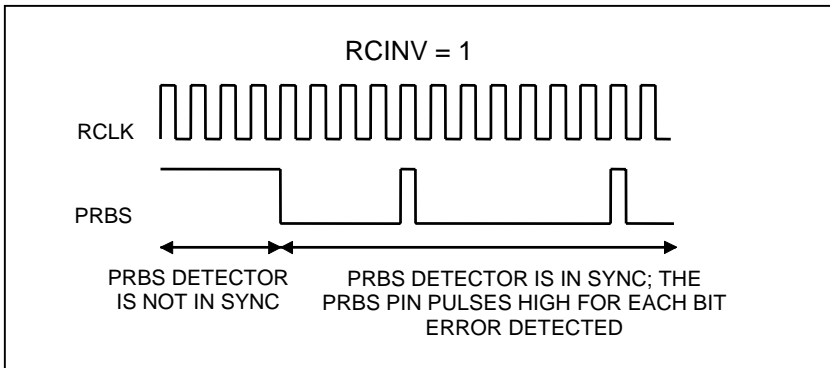

Figure 8-2. PRBS Output with Inverted RCLK Operation



9. JITTER ATTENUATOR

Each LIU contains an on-board jitter attenuator that can be placed in the receive path or the transmit path or can be disabled. The TJA and RJA pins (hardware mode) or the TJA and RJA control bits (CPU bus mode) specify how the jitter attenuator is used. Setting TJA = RJA = 0 disables the jitter attenuator. To use the jitter attenuator in the receive path, set RJA = 1 (with TJA = 0). To use it in the transmit path, set TJA = 1. [Figure 9-1](#) shows the minimum jitter attenuation for the device when the jitter attenuator is enabled. [Figure 9-1](#) also shows the receive jitter transfer when the jitter attenuator is disabled.

The jitter attenuator consists of a narrowband PLL to retime the selected clock, a 16 x 2-bit FIFO to buffer the associated data while the clock is being retimed, and logic to prevent FIFO over/underflow in the presence of very large jitter amplitudes.

The jitter attenuator requires a transmission-quality master clock (i.e., ±20ppm frequency accuracy and low jitter). When enabled in the receive path, the JA can obtain its master clock from the appropriate MCLK pin or the TCLK pin. If the signal on the MCLK pin is toggling, the JA uses the signal on the MCLK pin as its master clock. If the MCLK pin is high, the JA uses the signal on the TCLK pin as its master clock. When enabled in the transmit path,

the JA must take its master clock from the MCLK pin. The clock and data recovery block also uses the selected master clock.

The JA has a loop bandwidth of $\text{master_clock} / 2,058,874$ (see corner frequencies in [Figure 9-1](#)). The JA attenuates jitter at frequencies higher than the loop bandwidth, while allowing jitter (and wander) at lower frequencies to pass through relatively unaffected.

Figure 9-1. Jitter Attenuation/Jitter Transfer

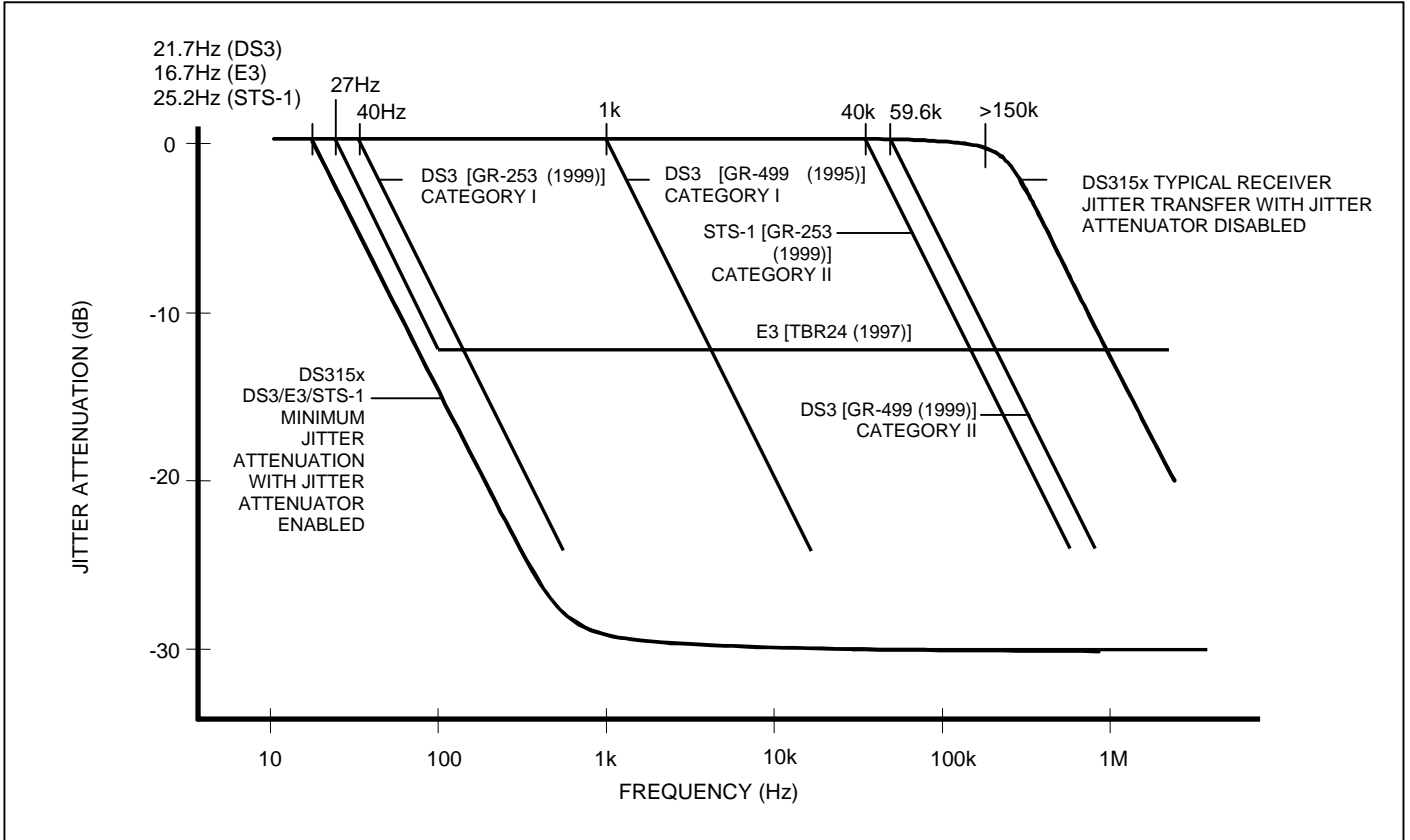

10. RESET LOGIC

There are four sources for reset: an internal power-on reset (POR) circuit, the reset pin $\overline{\text{RST}}$, the JTAG reset pin $\overline{\text{JTRST}}$, and the RST bit in each LIU's global configuration register (GCR). The chip is divided into three zones for reset: the digital logic, the analog circuits, and the JTAG logic. The digital logic includes the status and control registers, the B3ZS/HDB3 encoder and decoder, the PRBS generator and detector, and the LOS detect logic. The analog circuits include clock and data recovery, jitter attenuator, and transmit waveform generation. The JTAG logic consists of the common boundary scan controller and the boundary scan cells at each pin.

The POR circuit resets the digital logic, analog circuits, and JTAG logic zones. The $\overline{\text{RST}}$ pin resets the digital logic and the analog circuits but not the JTAG logic. The $\overline{\text{JTRST}}$ pin resets only the JTAG logic. Each LIU's RST register bit resets the digital logic for that LIU, including resetting the LIU's registers to the default state (except for the RST bit).

The POR signal and $\overline{\text{RST}}$ pin require an active master clock source for the LIU to properly reset.

11. TRANSFORMERS

Table 11-A. Transformer Characteristics

| PARAMETER | VALUE |
|--------------------------|----------------------------|
| Turns Ratio | 1:2ct \pm 2% |
| Bandwidth 75 Ω | 0.250MHz to 500MHz (typ) |
| Primary Inductance | 19 μ H (min) |
| Leakage Inductance | 0.150 μ H (max) |
| Interwinding Capacitance | 10pF (max) |
| Isolation Voltage | 1500V _{RMS} (min) |

Table 11-B. Recommended Transformers

| MANUFACTURER | NO. OF TRANSFORMERS | PART | TEMP RANGE | PIN-PACKAGE/ SCHEMATIC |
|-------------------|---------------------|-------------|--------------|------------------------|
| Pulse Engineering | 1 | PE-65968 | 0°C to +70°C | 6 SMT LS-1/C |
| | 1 | PE-65969 | 0°C to +70°C | 6 Thru-Hole LC-1/C |
| | 8 | T3049 | 0°C to +70°C | 32 SMT YB/1 |
| Halo Electronics | 1 | TG07-0206NS | 0°C to +70°C | 6 SMT SMD/B |
| | 1 | TD07-0206NE | 0°C to +70°C | 6 DIP DIP/B |

Note: Table subject to change. Industrial temperature range and other multiples (dual, quad) are also available. Contact the manufacturers for details at www.pulseeng.com and www.haloelectronics.com.

12. JTAG TEST ACCESS PORT AND BOUNDARY SCAN

12.1 JTAG Description

The DS315x LIUs support the standard instruction codes SAMPLE/PRELOAD, BYPASS, and EXTEST. Optional public instructions included are HIGHZ, CLAMP, and IDCODE. [Figure 12-1](#) features a block diagram. The LIUs contain the following items, which meet the requirements set by the IEEE 1149.1 Standard Test Access Port and Boundary Scan Architecture:

Test Access Port (TAP)
TAP Controller
Instruction Register

Bypass Register
Boundary Scan Register
Device Identification Register

The TAP has the necessary interface pins, namely JTCLK, $\overline{\text{JTRST}}$, JTDI, JTDO, and JTMS. Details on these pins can be found in [Section 4](#). Details about the boundary scan architecture and the TAP can be found in IEEE 1149.1-1990, IEEE 1149.1a-1993, and IEEE 1149.1b-1994.

Figure 12-1. JTAG Block Diagram

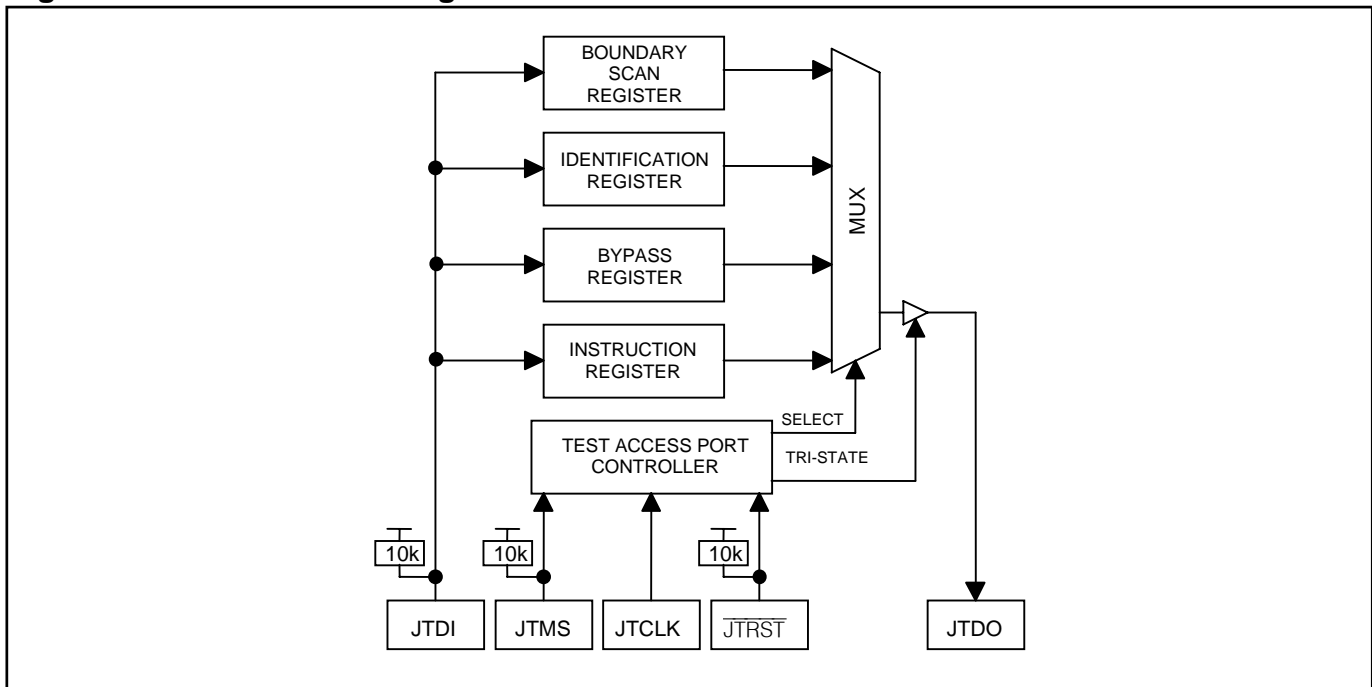

12.2 JTAG TAP Controller State Machine Description

This section discusses the operation of the TAP controller state machine. The TAP controller is a finite state machine that responds to the logic level at JTMS on the rising edge of JTCLK. Each of the states denoted in [Figure 12-2](#) are described in the following pages.

Figure 12-2. JTAG TAP Controller State Machine

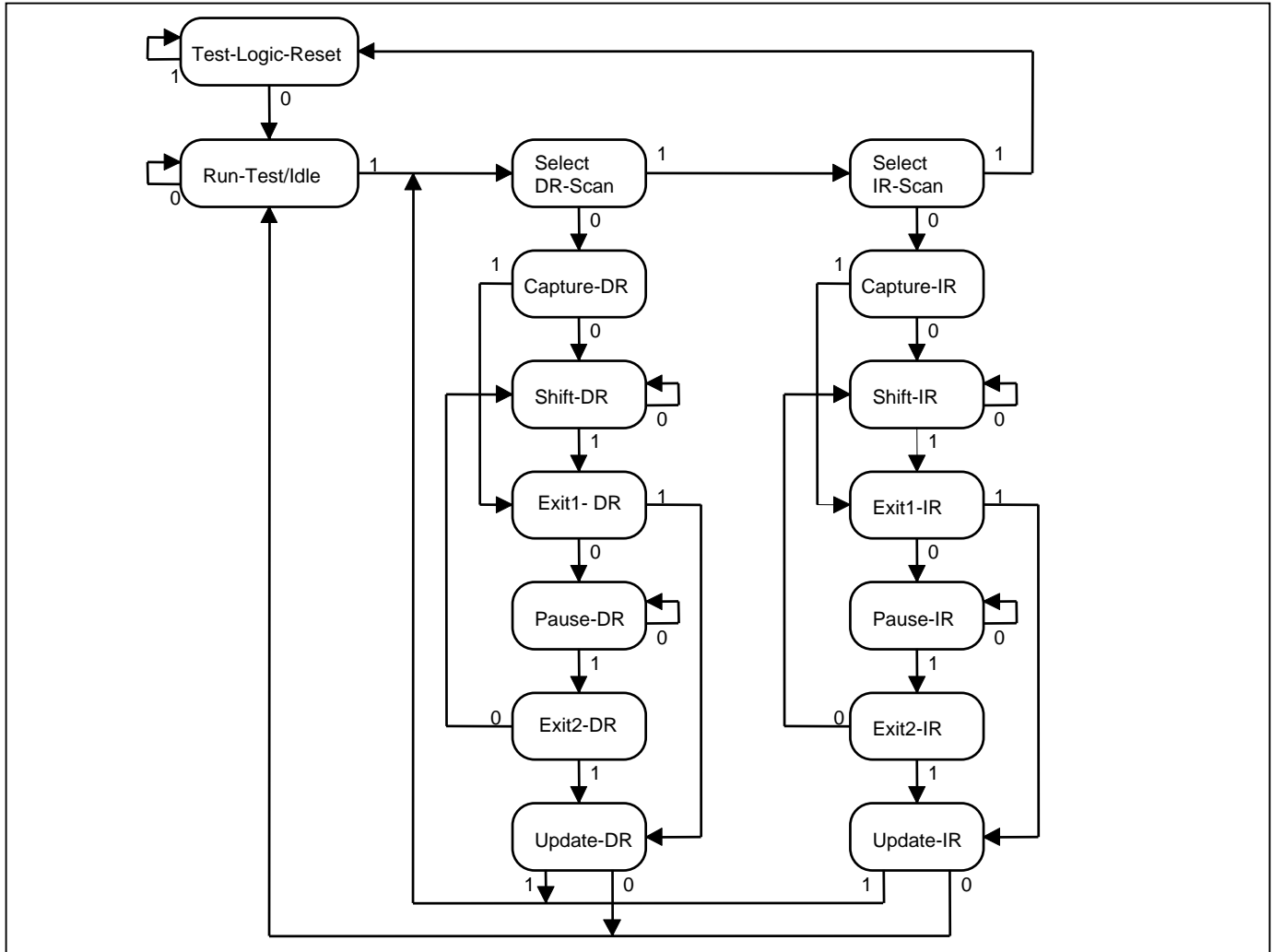

Test-Logic-Reset. Upon device power-up, the TAP controller starts in the Test-Logic-Reset state. The instruction register contains the IDCODE instruction. All system logic on the device operates normally.

Run-Test-Idle. Run-Test-Idle is used between scan operations or during specific tests. The instruction and test registers remain idle.

Select-DR-Scan. All test registers retain their previous state. With JTMS low, a rising edge of JTCLK moves the controller into the Capture-DR state and initiates a scan sequence. JTMS high moves the controller to the Select-IR-SCAN state.

Capture-DR. Data can be parallel loaded into the test data registers selected by the current instruction. If the instruction does not call for a parallel load or the selected register does not allow parallel loads, the test register remains at its current value. On the rising edge of JTCLK, the controller goes to the Shift-DR state if JTMS is low or to the Exit1-DR state if JTMS is high.

Shift-DR. The test data register selected by the current instruction is connected between JTDI and JTDO and shifts data one stage toward its serial output on each rising edge of JTCLK. If a test register selected by the current instruction is not placed in the serial path, it maintains its previous state.

Exit1-DR. While in this state, a rising edge on JTCLK with JTMS high puts the controller in the Update-DR state, which terminates the scanning process. A rising edge on JTCLK with JTMS low puts the controller in the Pause-DR state.

Pause-DR. Shifting of the test registers is halted while in this state. All test registers selected by the current instruction retain their previous state. The controller remains in this state while JTMS is low. A rising edge on JTCLK with JTMS high puts the controller in the Exit2-DR state.

Exit2-DR. While in this state, a rising edge on JTCLK with JTMS high puts the controller in the Update-DR state and terminates the scanning process. A rising edge on JTCLK with JTMS low puts the controller in the Shift-DR state.

Update-DR. A falling edge on JTCLK while in the Update-DR state latches the data from the shift register path of the test registers into the data output latches. This prevents changes at the parallel output because of changes in the shift register. A rising edge on JTCLK with JTMS low puts the controller in the Run-Test-Idle state. With JTMS high, the controller enters the Select-DR-Scan state.

Select-IR-Scan. All test registers retain their previous state. The instruction register remains unchanged during this state. With JTMS low, a rising edge on JTCLK moves the controller into the Capture-IR state and initiates a scan sequence for the instruction register. JTMS high during a rising edge on JTCLK puts the controller back into the Test-Logic-Reset state.

Capture-IR. The Capture-IR state is used to load the shift register in the instruction register with a fixed value. This value is loaded on the rising edge of JTCLK. If JTMS is high on the rising edge of JTCLK, the controller enters the Exit1-IR state. If JTMS is low on the rising edge of JTCLK, the controller enters the Shift-IR state.

Shift-IR. In this state, the instruction register's shift register is connected between JTDI and JTDO and shifts data one stage for every rising edge of JTCLK toward the serial output. The parallel register and the test registers remain at their previous states. A rising edge on JTCLK with JTMS high moves the controller to the Exit1-IR state. A rising edge on JTCLK with JTMS low keeps the controller in the Shift-IR state, while moving data one stage through the instruction shift register.

Exit1-IR. A rising edge on JTCLK with JTMS low puts the controller in the Pause-IR state. If JTMS is high on the rising edge of JTCLK, the controller enters the Update-IR state and terminates the scanning process.

Pause-IR. Shifting of the instruction register is halted temporarily. With JTMS high, a rising edge on JTCLK puts the controller in the Exit2-IR state. The controller remains in the Pause-IR state if JTMS is low during a rising edge on JTCLK.

Exit2-IR. A rising edge on JTCLK with JTMS high puts the controller in the Update-IR state. The controller loops back to the Shift-IR state if JTMS is low during a rising edge of JTCLK in this state.

Update-IR. The instruction shifted into the instruction shift register is latched into the parallel output on the falling edge of JTCLK as the controller enters this state. Once latched, this instruction becomes the current instruction. A rising edge on JTCLK with JTMS low puts the controller in the Run-Test-Idle state. With JTMS high, the controller enters the Select-DR-Scan state.

12.3 JTAG Instruction Register and Instructions

The instruction register contains a shift register as well as a latched parallel output and is 3 bits in length. When the TAP controller enters the Shift-IR state, the instruction shift register is connected between JTDI and JTDO. While in the Shift-IR state, a rising edge on JTCLK with JTMS low shifts data one stage toward the serial output at JTDO. A rising edge on JTCLK in the Exit1-IR state or the Exit2-IR state with JTMS high moves the controller to the Update-IR state. The falling edge of that same JTCLK latches the data in the instruction shift register to the instruction parallel output. [Table 12-A](#) shows the instructions supported by the DS315x and their respective operational binary codes.

Table 12-A. JTAG Instruction Codes

| INSTRUCTIONS | SELECTED REGISTER | INSTRUCTION CODES |
|----------------|-----------------------|-------------------|
| SAMPLE/PRELOAD | Boundary Scan | 010 |
| BYPASS | Bypass | 111 |
| EXTEST | Boundary Scan | 000 |
| CLAMP | Bypass | 011 |
| HIGHZ | Bypass | 100 |
| IDCODE | Device Identification | 001 |

SAMPLE/PRELOAD. SAMPLE/RELOAD is a mandatory instruction for the IEEE 1149.1 specification. This instruction supports two functions. The digital I/Os of the device can be sampled at the boundary scan register without interfering with the device's normal operation by using the Capture-DR state. SAMPLE/PRELOAD also allows the DS315x to shift data into the boundary scan register through JTDI using the Shift-DR state.

EXTEST. EXTEST allows testing of the interconnections to the device. When the EXTEST instruction is latched in the instruction register, the following actions occur. Once enabled through the Update-IR state, the parallel outputs of the digital output pins are driven. The boundary scan register is connected between JTDI and JTDO. The Capture-DR samples all digital inputs into the boundary scan register.

BYPASS. When the BYPASS instruction is latched into the parallel instruction register, JTDI connects to JTDO through the 1-bit bypass test register. This allows data to pass from JTDI to JTDO without affecting the device's normal operation.

IDCODE. When the IDCODE instruction is latched into the parallel instruction register, the identification test register is selected. The device identification code is loaded into the identification register on the rising edge of JTCLK, following entry into the Capture-DR state. Shift-DR can be used to shift the identification code out serially through JTDO. During Test-Logic-Reset, the identification code is forced into the instruction register's parallel output.

HIGHZ. All digital outputs are placed into a high-impedance state. The bypass register is connected between JTDI and JTDO.

CLAMP. All digital output pins output data from the boundary scan parallel output while connecting the bypass register between JTDI and JTDO. The outputs do not change during the CLAMP instruction.

Table 12-B. JTAG ID Code

| PART | REVISION | DEVICE CODE | MANUFACTURER CODE | REQUIRED |
|--------|-----------------|------------------|-------------------|----------|
| DS3154 | Consult factory | 0000000000110011 | 00010100001 | 1 |
| DS3153 | Consult factory | 0000000000110010 | 00010100001 | 1 |
| DS3152 | Consult factory | 0000000000110000 | 00010100001 | 1 |
| DS3151 | Consult factory | 0000000000100000 | 00010100001 | 1 |

12.4 JTAG Test Registers

IEEE 1149.1 requires a minimum of two test registers—the bypass register and the boundary scan register. An optional test register, the identification register, has been included in the device design. It is used with the IDCODE instruction and the Test-Logic-Reset state of the TAP controller.

Bypass Register. This single 1-bit shift register, used with the BYPASS, CLAMP, and HIGHZ instructions, provides a short path between JTDI and JTDO.

Boundary Scan Register. This register contains a shift register path and a latched parallel output for control cells and digital I/O cells. DS315x BSDL files are available at www.maxim-ic.com/TechSupport/telecom/bsdl.htm.

Identification Register. This register contains a 32-bit shift register and a 32-bit latched parallel output. It is selected during the IDCODE instruction and when the TAP controller is in the Test-Logic-Reset state.

13. ELECTRICAL CHARACTERISTICS

ABSOLUTE MAXIMUM RATINGS

| | |
|---|--|
| Voltage Range on Any Lead with Respect to V_{SS} (except V_{DD}) | -0.3V to +5.5V |
| Supply Voltage Range (V_{DD}) with Respect to V_{SS} | -0.3V to +3.63V |
| Ambient Operating Temperature Range | -40°C to +85°C |
| Junction Operating Temperature Range | -40°C to +125°C |
| Storage Temperature Range | -55°C to +125°C |
| Soldering Temperature | See IPC/JEDEC J-STD-020A Specification |

Stresses beyond those listed under "Absolute Maximum Ratings" may cause permanent damage to the device. These are stress ratings only, and functional operation of the device at these or any other conditions beyond those indicated in the operational sections of the specifications is not implied. Exposure to the absolute maximum rating conditions for extended periods may affect device reliability. Ambient operating temperature range when device is mounted on a four-layer JEDEC test board with no airflow.

Note: The typical values listed in Tables 13-A through 13-I are not production tested.

Table 13-A. Recommended DC Operating Conditions

($T_A = -40^\circ\text{C}$ to $+85^\circ\text{C}$)

| PARAMETER | SYMBOL | CONDITIONS | MIN | TYP | MAX | UNITS |
|----------------|----------|------------|-------|-----|-------|-------|
| Logic 1 | V_{IH} | | 2.0 | | 5.5 | V |
| Logic 0 | V_{IL} | | -0.3 | | +0.8 | V |
| Supply Voltage | V_{DD} | | 3.135 | 3.3 | 3.465 | V |

Table 13-B. DC Characteristics

($V_{DD} = 3.3\text{V} \pm 5\%$, $T_A = -40^\circ\text{C}$ to $+85^\circ\text{C}$.)

| PARAMETER | SYMBOL | CONDITIONS | MIN | TYP | MAX | UNITS |
|--|-------------|-----------------|-----|-----|----------|---------------|
| Supply Current (Note 1) | I_{DD} | DS3151 | | 75 | 100 | mA |
| | | DS3152 | | 150 | 200 | |
| | | DS3153 | | 225 | 300 | |
| | | DS3154 | | 300 | 400 | |
| Supply Current, Transmitters Tri-Stated (All TTS_n Low) (Note 2) | I_{DDTTS} | DS3151 | | 65 | 80 | mA |
| | | DS3152 | | 120 | 150 | |
| | | DS3153 | | 180 | 225 | |
| | | DS3154 | | 240 | 300 | |
| Power-Down Current (All TPD, RPD Control Bits High) | I_{DDPD} | DS315x (Note 2) | | 55 | 70 | mA |
| Lead Capacitance | C_{IO} | | | 7 | | pF |
| Input Leakage | I_{IL} | (Note 3) | -50 | | +10 | μA |
| Output Leakage (when High-Z) | I_{LO} | (Note 3) | -10 | | +10 | μA |
| Output Voltage ($I_O = -4.0\text{mA}$) | V_{OH} | | 2.4 | | V_{DD} | V |
| Output Voltage ($I_O = +4.0\text{mA}$) | V_{OL} | | 0 | | 0.4 | V |

Note 1: $TCLK_n = STMCLK = 51.84\text{MHz}$; TXP_n/TXN_n driving all ones into 75Ω resistive loads; analog loopback enabled; all other inputs at V_{DD} or grounded; all other outputs open.

Note 2: $TCLK_n = STMCLK = 51.84\text{MHz}$; other inputs at V_{DD} or grounded; digital outputs left open circuited.

Note 3: $0\text{V} < V_{IN} < V_{DD}$.

Table 13-C. Framer Interface Timing

($V_{DD} = 3.3V \pm 5\%$, $T_A = -40^{\circ}C$ to $+85^{\circ}C$.) (Figure 13-1 and Figure 13-2)

| PARAMETER | SYMBOL | CONDITIONS | MIN | TYP | MAX | UNITS |
|---|--------------|------------------|-----|------|-----|-------|
| RCLK/TCLK Clock Period | t1 | (Note 4) | | 22.4 | | ns |
| | | (Note 5) | | 29.1 | | |
| | | (Note 6) | | 19.3 | | |
| RCLK Duty Cycle | t2/t1, t3/t1 | (Notes 7, 8) | 45 | 50 | 55 | % |
| TCLK Duty Cycle | t2/t1, t3/t1 | (Note 8) | 30 | | 70 | % |
| MCLK Duty Cycle | t2/t1, t3/t1 | (Note 8) | 30 | | 70 | % |
| TPOS/TDAT, TNEG to TCLK Setup Time | t4 | (Notes 8, 9) | 2 | | | ns |
| TPOS/TDAT, TNEG Hold Time | t5 | (Notes 8, 9) | 2 | | | ns |
| RCLK to RPOS/RDAT, RNEG/RLCV, and PRBS Value Change | t6 | (Notes 7, 8, 10) | 2 | | 6 | ns |
| RCLK Rise and Fall Time | t7 | (Notes 8, 11) | | 5 | | ns |
| TCLK Rise and Fall Time | t8 | (Notes 8, 12) | | | 5 | ns |

Note 4: DS3 mode.

Note 5: E3 mode.

Note 6: STS-1 mode.

Note 7: Outputs loaded with 25pF, measured at 50% threshold.

Note 8: Not tested during production test.

Note 9: When TCINV = 0, TPOS/TDAT and TNEG are sampled on the rising edge of TCLK. When TCINV = 1, TPOS/TDAT and TNEG are sampled on the falling edge of TCLK.

Note 10: When RCINV = 0, RPOS/RDAT and RNEG/RLCV are updated on the falling edge of RCLK. When RCINV = 1, RPOS/RDAT and RNEG/RLCV are updated on the rising edge of RCLK.

Note 11: Outputs loaded with 25pF, measured between V_{OL} (max) and V_{OH} (min).

Note 12: Measured between V_{IL} (max) and V_{IH} (min).

Figure 13-1. Transmitter Framer Interface Timing Diagram

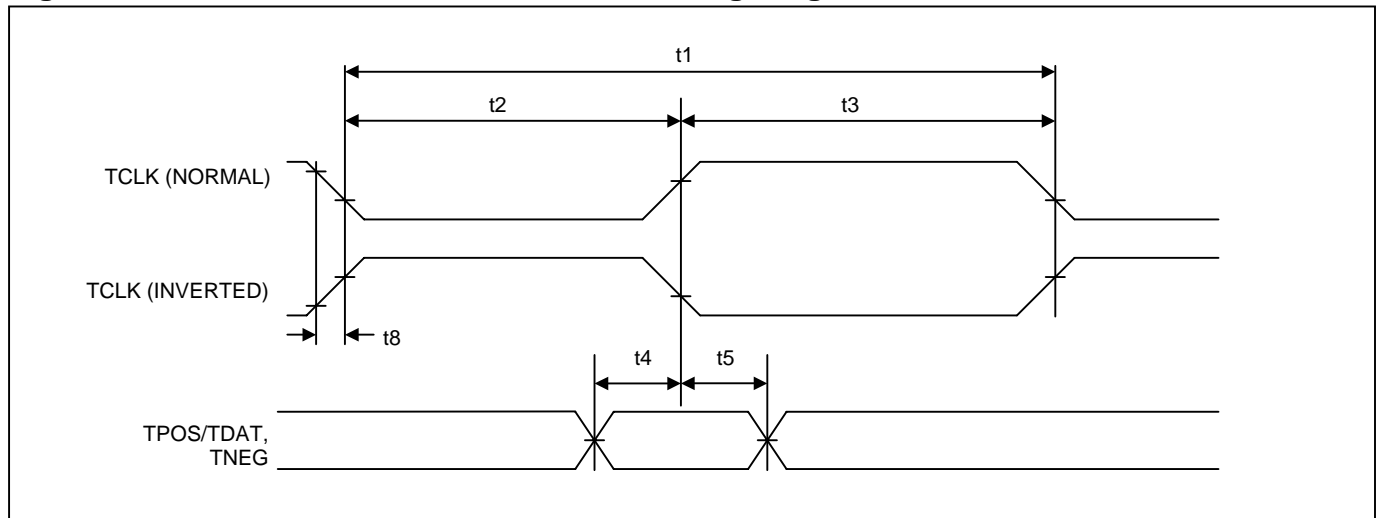

Figure 13-2. Receiver Framer Interface Timing Diagram

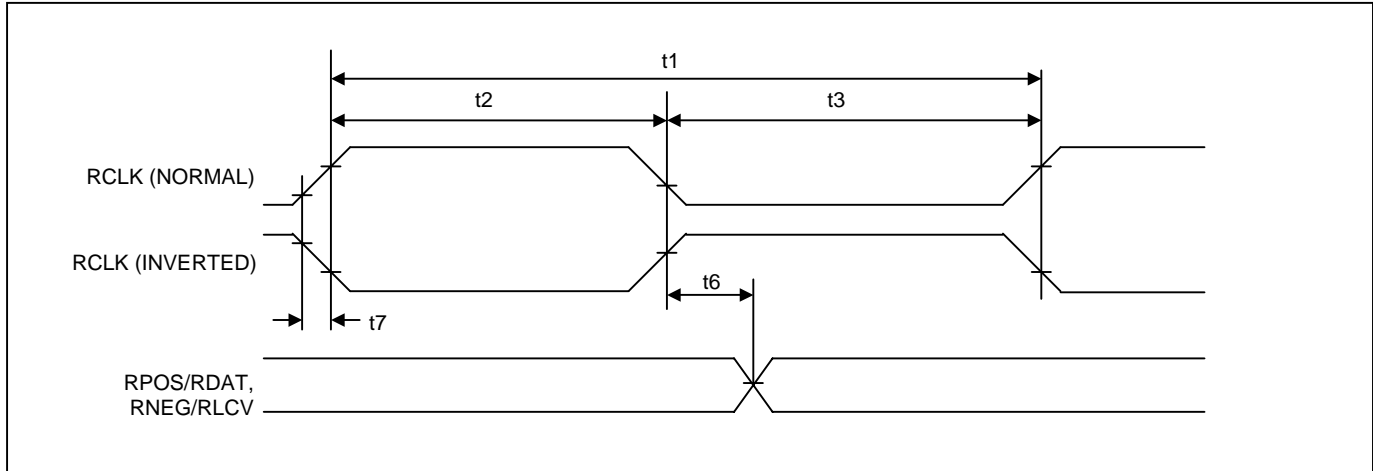

Table 13-D. Receiver Input Characteristics—DS3 and STS-1 Modes

($V_{DD} = 3.3V \pm 5\%$, $T_A = -40^{\circ}C$ to $+85^{\circ}C$.)

| PARAMETER | MIN | TYP | MAX | UNITS |
|---|-----|------|------|-------------------|
| Receive Sensitivity (Length of Cable) | 900 | 1200 | | ft |
| Signal-to-Noise Ratio, Interfering Signal Test (Notes 13, 14) | | 10 | | |
| Input Pulse Amplitude, RMON = 0 (Notes 14, 15) | | | 1000 | mVpk |
| Input Pulse Amplitude, RMON = 1 (Note 14, 15) | | | 200 | mVpk |
| Analog LOS Declare, RMON = 0 (Note 16) | | -24 | | dB |
| Analog LOS Clear, RMON = 0 (Note 16) | | -21 | | dB |
| Analog LOS Declare, RMON = 1 (Note 16) | | -38 | | dB |
| Analog LOS Clear, RMON = 1 (Note 16) | | -35 | | dB |
| Intrinsic Jitter Generation (Note 14) | | 0.03 | | UI _{P-P} |

Table 13-E. Receiver Input Characteristics—E3 Mode

($V_{DD} = 3.3V \pm 5\%$, $T_A = -40^{\circ}C$ to $+85^{\circ}C$.)

| PARAMETER | MIN | TYP | MAX | UNITS |
|---|-----|------|------|-------------------|
| Receive Sensitivity (Length of Cable) | 900 | 1200 | | ft |
| Signal-to-Noise Ratio, Interfering Signal Test (Notes 13, 14) | | 12 | | |
| Input Pulse Amplitude, RMON = 0 (Notes 14, 15) | | | 1300 | mVpk |
| Input Pulse Amplitude, RMON = 1 (Notes 14, 15) | | | 260 | mVpk |
| Analog LOS Declare, RMON = 0 (Note 16) | | -24 | | dB |
| Analog LOS Clear, RMON = 0 (Note 16) | | -21 | | dB |
| Analog LOS Declare, RMON = 1 (Note 16) | | -38 | | dB |
| Analog LOS Clear, RMON = 1 (Note 16) | | -35 | | dB |
| Intrinsic Jitter Generation (Note 14) | | 0.03 | | UI _{P-P} |

Note 13: An interfering signal ($2^{15} - 1$ PRBS for DS3/STS-1, $2^{23} - 1$ PRBS for E3, B3ZS/HDB3 encoded, compliant waveshape, nominal bit rate) is added to the wanted signal. The combined signal is passed through 0 to 900ft of coaxial cable and presented to the DS3154 receiver. This spec indicates the lowest signal-to-noise ratio that results in a bit error ratio $\leq 10^{-9}$.

Note 14: Not tested during production test.

Note 15: Measured on the line side (i.e., the BNC connector side) of the 1:2 receive transformer (Figure 1-1). During measurement, incoming data traffic is unframed $2^{15} - 1$ PRBS for DS3/STS-1 and unframed $2^{23} - 1$ PRBS for E3.

Note 16: With respect to nominal 800mVpk signal for DS3/STS-1 and nominal 1000mVpk signal for E3.

Table 13-F. Transmitter Output Characteristics—DS3 and STS-1 Modes(V_{DD} = 3.3V ±5%, T_A = -40°C to +85°C.)

| PARAMETER | MIN | TYP | MAX | UNITS |
|---|------|------|------|-------------------|
| DS3 Output Pulse Amplitude, TLBO = 0 (Note 17) | 700 | 800 | 900 | mVpk |
| DS3 Output Pulse Amplitude, TLBO = 1 (Note 17) | 520 | 700 | 800 | mVpk |
| STS-1 Output Pulse Amplitude, TLBO = 0 (Note 17) | 700 | 800 | 1100 | mVpk |
| STS-1 Output Pulse Amplitude, TLBO = 1 (Note 17) | 520 | 700 | 850 | mVpk |
| Ratio of Positive and Negative Pulse-Peak Amplitudes | 0.9 | | 1.1 | |
| DS3 Unframed All-Ones Power Level at 22.368MHz, 3kHz Bandwidth | -1.8 | | +5.7 | dBm |
| DS3 Unframed All-Ones Power Level at 44.736MHz vs. Power Level at 22.368MHz, 3kHz Bandwidth | | | -20 | dB |
| Intrinsic Jitter Generation (Note 18) | | 0.02 | 0.05 | UI _{P-P} |

Table 13-G. Transmitter Output Characteristics—E3 Mode(V_{DD} = 3.3V ±5%, T_A = -40°C to +85°C.)

| PARAMETER | MIN | TYP | MAX | UNITS |
|---|------|-------|------|-------------------|
| Output Pulse Amplitude (Note 17) | 900 | 1000 | 1100 | mVpk |
| Pulse Width | | 14.55 | | ns |
| Ratio of Positive and Negative Pulse Amplitudes (at Centers of Pulses) | 0.95 | | 1.05 | |
| Ratio of Positive and Negative Pulse Widths (at Nominal Half Amplitude) | 0.95 | | 1.05 | |
| Intrinsic Jitter Generation (Note 18) | | 0.02 | 0.05 | UI _{P-P} |

Note 17: Measured on the line side (i.e., the BNC connector side) of the 2:1 transmit transformer (Figure 1-1).**Note 18:** Measured with jitter-free clock applied to TCLK and a bandpass jitter filter with 10Hz and 800kHz cutoff frequencies. Not tested during production test.**Table 13-H. CPU Bus Timing**(V_{DD} = 3.3V ±5%, T_A = -40°C to +85°C.) (Figure 13-3 and Figure 13-4)

| PARAMETER | SYMBOL | MIN | TYP | MAX | UNITS |
|---|--------|-----|-----|-----|-------|
| Setup Time for A[5:0] Valid to \overline{CS} Active (Notes 19, 20) | t1 | 0 | | | ns |
| Setup Time for \overline{CS} Active to RD, WR, or \overline{DS} Active | t2 | 0 | | | ns |
| Delay Time from RD or \overline{DS} Active to D[7:0] Valid | t3 | | | 65 | ns |
| Hold Time from RD or WR or \overline{DS} Inactive to \overline{CS} Inactive | t4 | 0 | | | ns |
| Delay from \overline{CS} or RD or \overline{DS} Inactive to D[7:0] Invalid or Tri-State (Note 21) | t5 | 2 | | 20 | ns |
| Wait Time from WR or \overline{DS} Active to Latch D[7:0] | t6 | 65 | | | ns |
| D[7:0] Setup Time to WR or \overline{DS} Inactive | t7 | 10 | | | ns |
| D[7:0] Hold Time from WR or \overline{DS} Inactive | t8 | 2 | | | ns |
| A[5:0] Hold Time from WR or RD or \overline{DS} Inactive | t9 | 5 | | | ns |
| RD, WR, or \overline{DS} Inactive Time | t10 | 75 | | | ns |
| Muxed Address Valid to ALE Falling (Note 22) | t11 | 10 | | | ns |
| Muxed Address Hold Time (Note 22) | t12 | 10 | | | ns |
| ALE Pulse Width (Note 22) | t13 | 30 | | | ns |
| Setup Time for ALE High or Muxed Address Valid to \overline{CS} Active (Note 22) | t14 | 0 | | | ns |

Note 19: D[7:0] loaded with 50pF when tested as outputs.**Note 20:** If a gapped clock is applied on TCLK and diagnostic loopback is enabled, read cycle time must be extended by the length of the largest TCLK gap.**Note 21:** Not tested during production test.**Note 22:** In nonmultiplexed bus applications (Figure 13-3), ALE should be wired high. In multiplexed bus applications (Figure 13-4), A[5:0] should be wired to D[5:0] and the falling edge of ALE latches the address.

Figure 13-3. CPU Bus Timing Diagram (Nonmultiplexed)

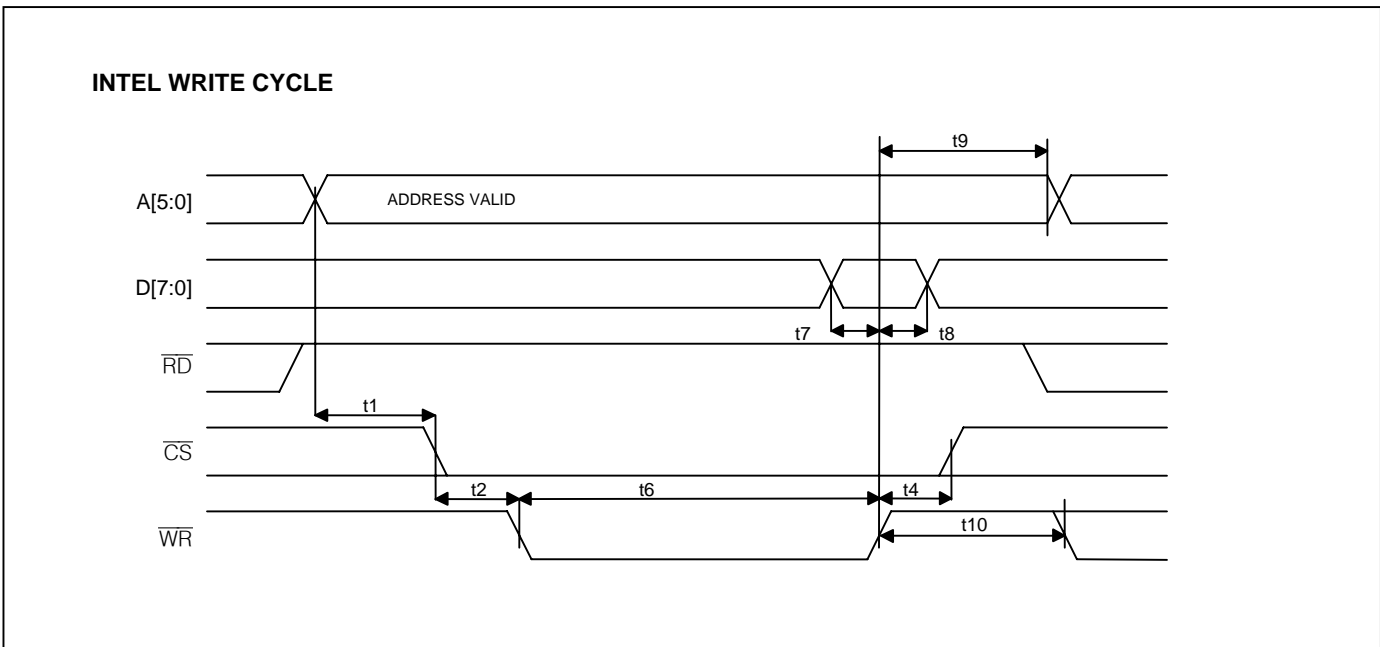
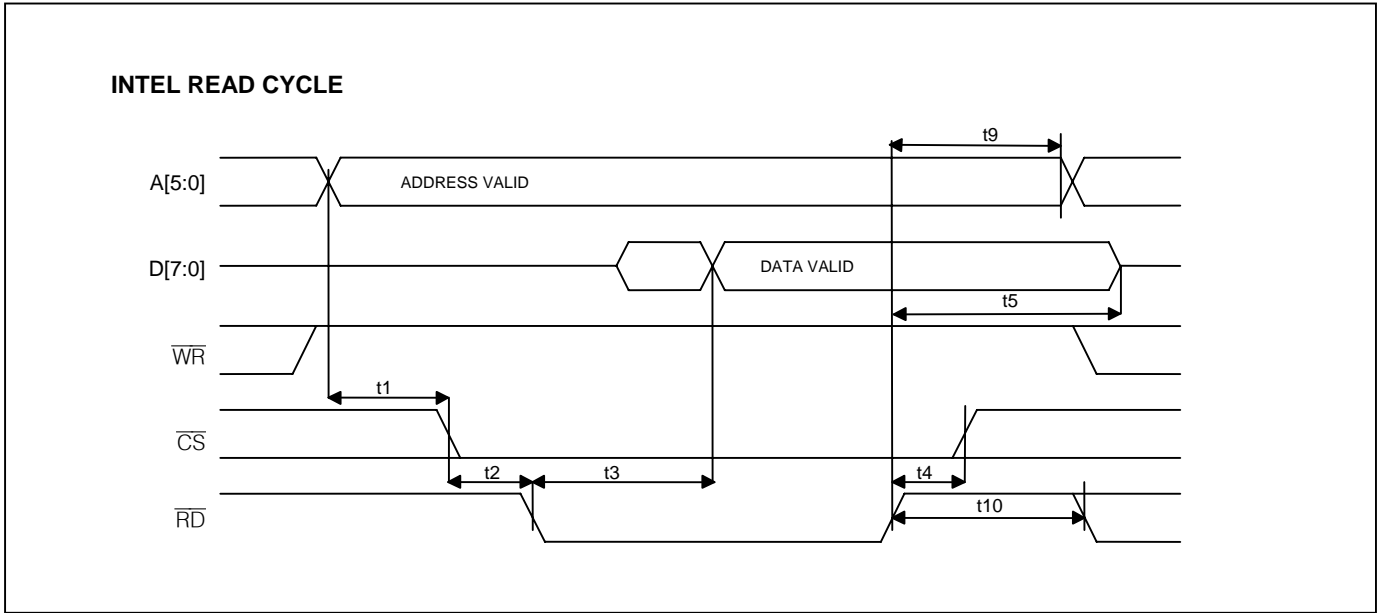

Figure 13-3. CPU Bus Timing Diagram (Nonmultiplexed)(continued)

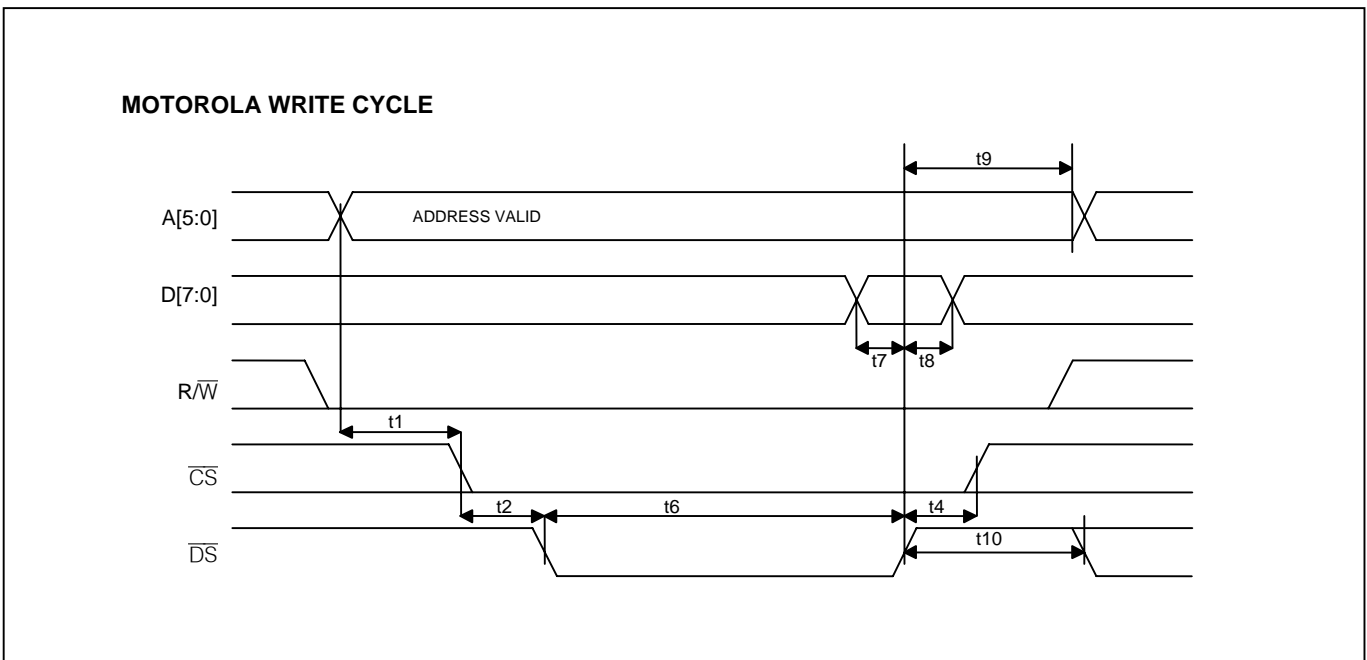
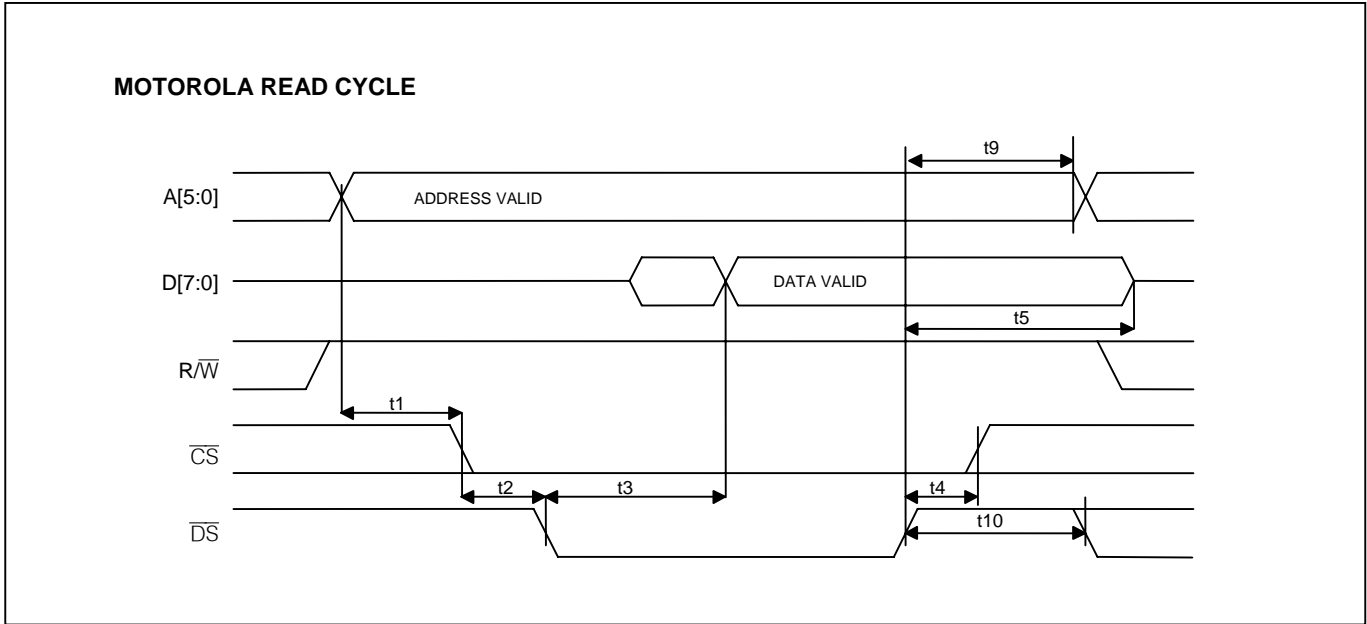
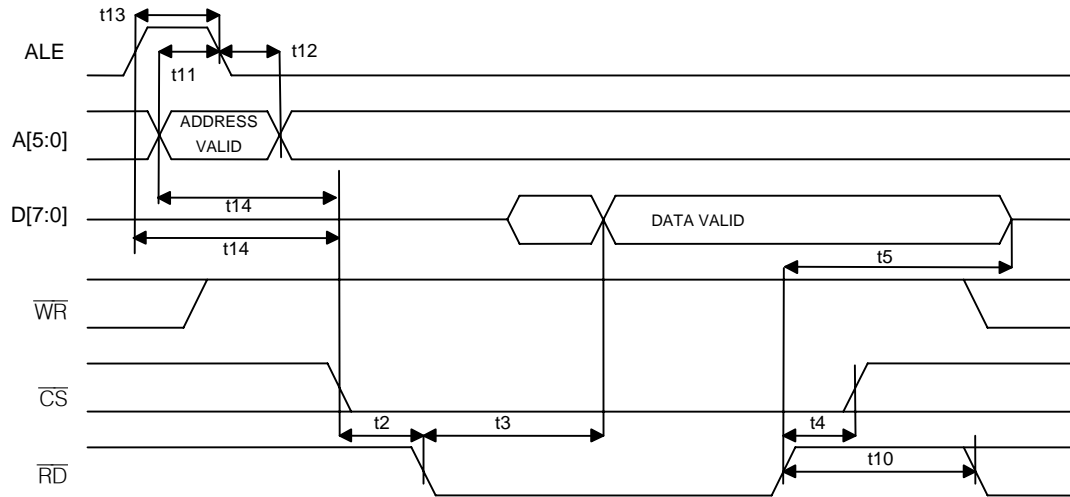

Figure 13-4. CPU Bus Timing Diagram (Multiplexed)

INTEL READ CYCLE



NOTE: t_{14} STARTS ON THE OCCURRENCE OF EITHER THE RISING EDGE OF ALE OR A VALID ADDRESS, WHICHEVER OCCURS LAST.
NOTE: TO AVOID BUS CONTENTION, STOP DRIVING A[5:0] BEFORE \overline{RD} GOES LOW.

INTEL WRITE CYCLE

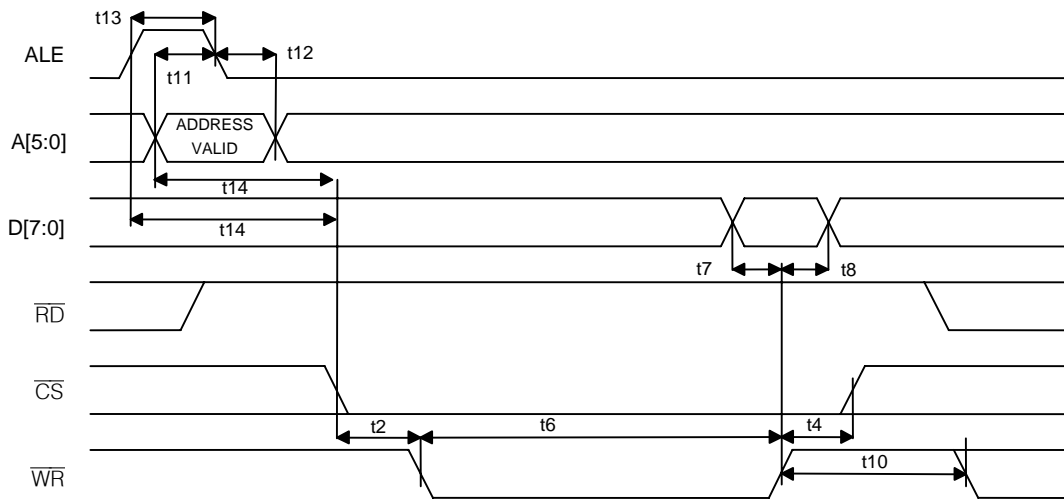

NOTE: t_{14} STARTS ON THE OCCURRENCE OF EITHER THE RISING EDGE OF ALE OR A VALID ADDRESS, WHICHEVER OCCURS LAST.

Figure 13-4. CPU Bus Timing Diagram (Multiplexed) (continued)

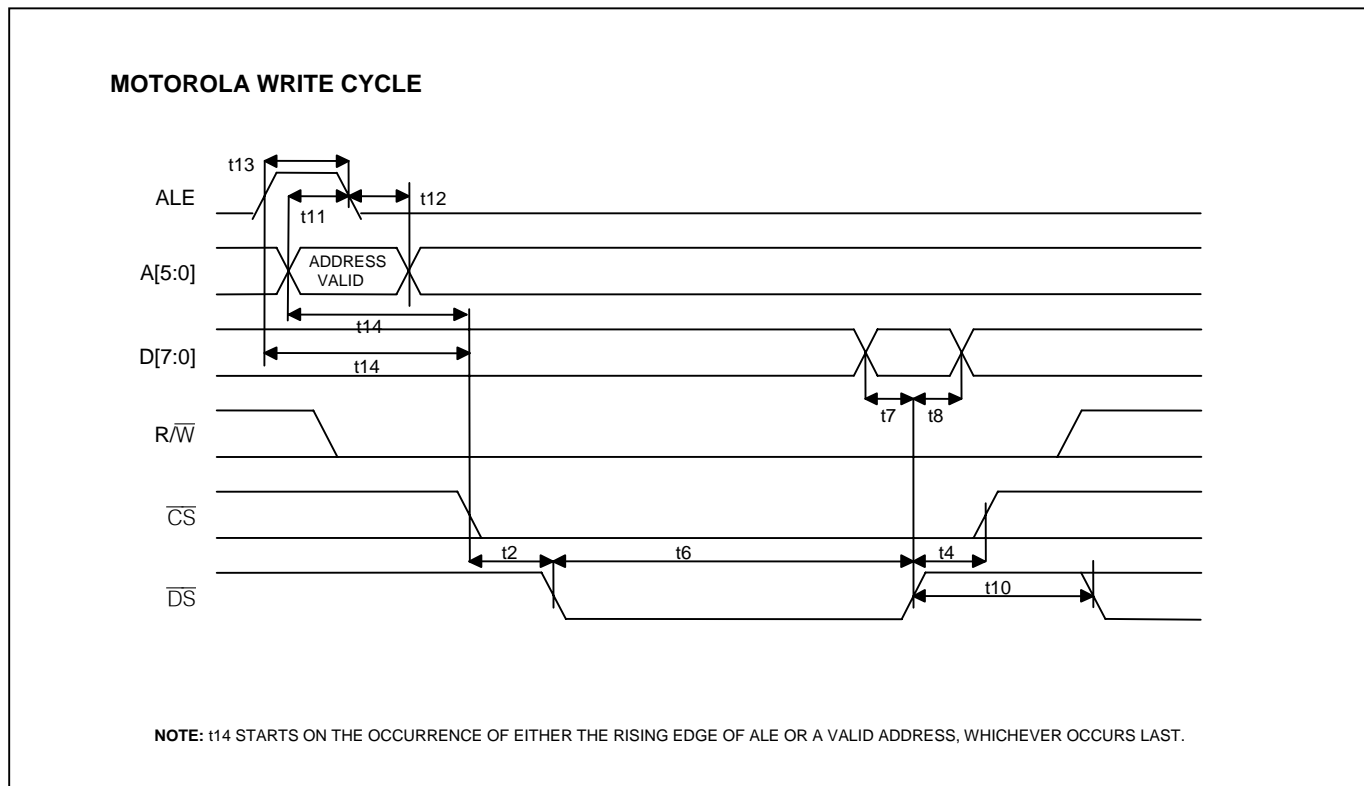
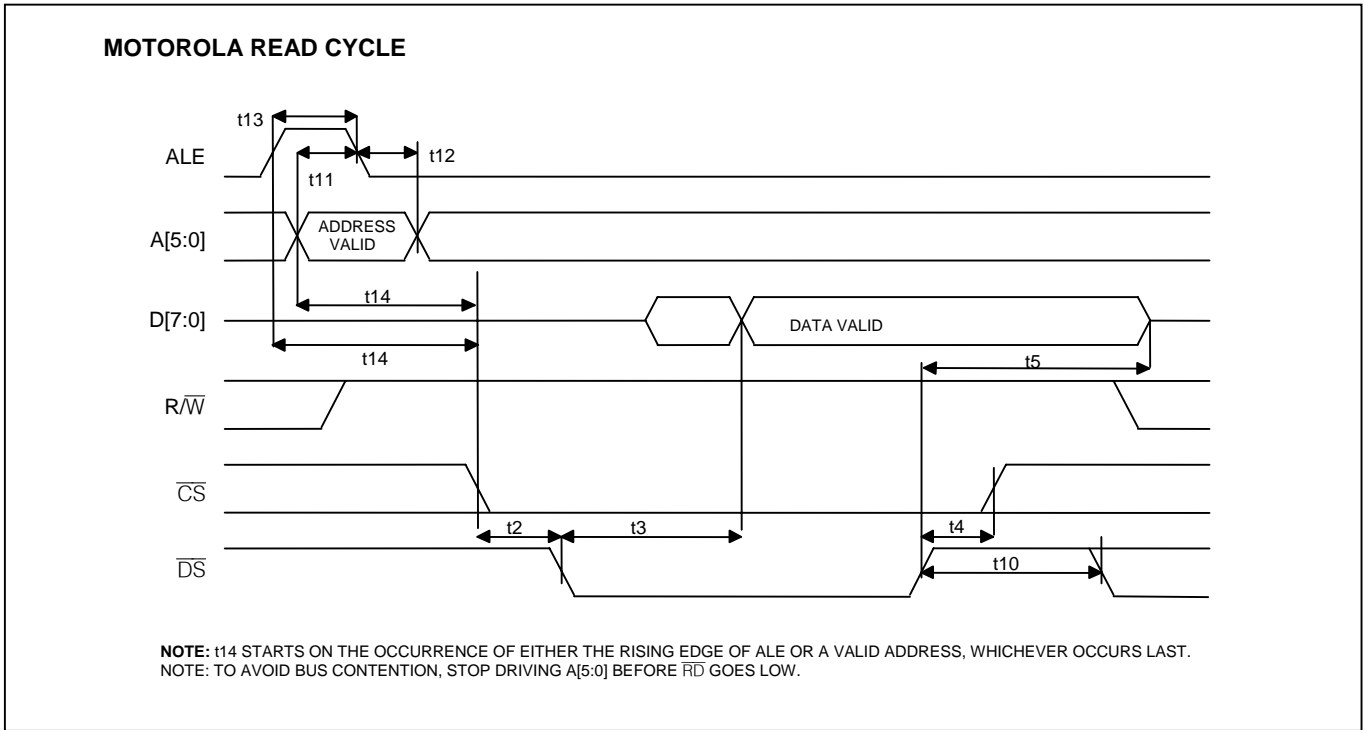

Table 13-I. JTAG Interface Timing

($V_{DD} = 3.3V \pm 5\%$, $T_A = -40^\circ C$ to $+85^\circ C$.) (Figure 13-5)

| PARAMETER | SYMBOL | MIN | TYP | MAX | UNITS |
|--------------------------------------|--------|-----|------|-----|-------|
| JTCLK Clock Period | t1 | | 1000 | | ns |
| JTCLK Clock High/Low Time (Note 23) | t2/t3 | 50 | 500 | | ns |
| JTCLK to JTDI, JTMS Setup Time | t4 | 50 | | | ns |
| JTCLK to JTDI, JTMS Hold Time | t5 | 50 | | | ns |
| JTCLK to JTDO Delay | t6 | 2 | | 50 | ns |
| JTCLK to JTDO High-Z Delay (Note 24) | t7 | 2 | | 50 | ns |
| JTRST Width Low Time | t8 | 100 | | | ns |

Note 23: Clock can be stopped high or low.

Note 24: Not tested during production test.

Figure 13-5. JTAG Timing Diagram

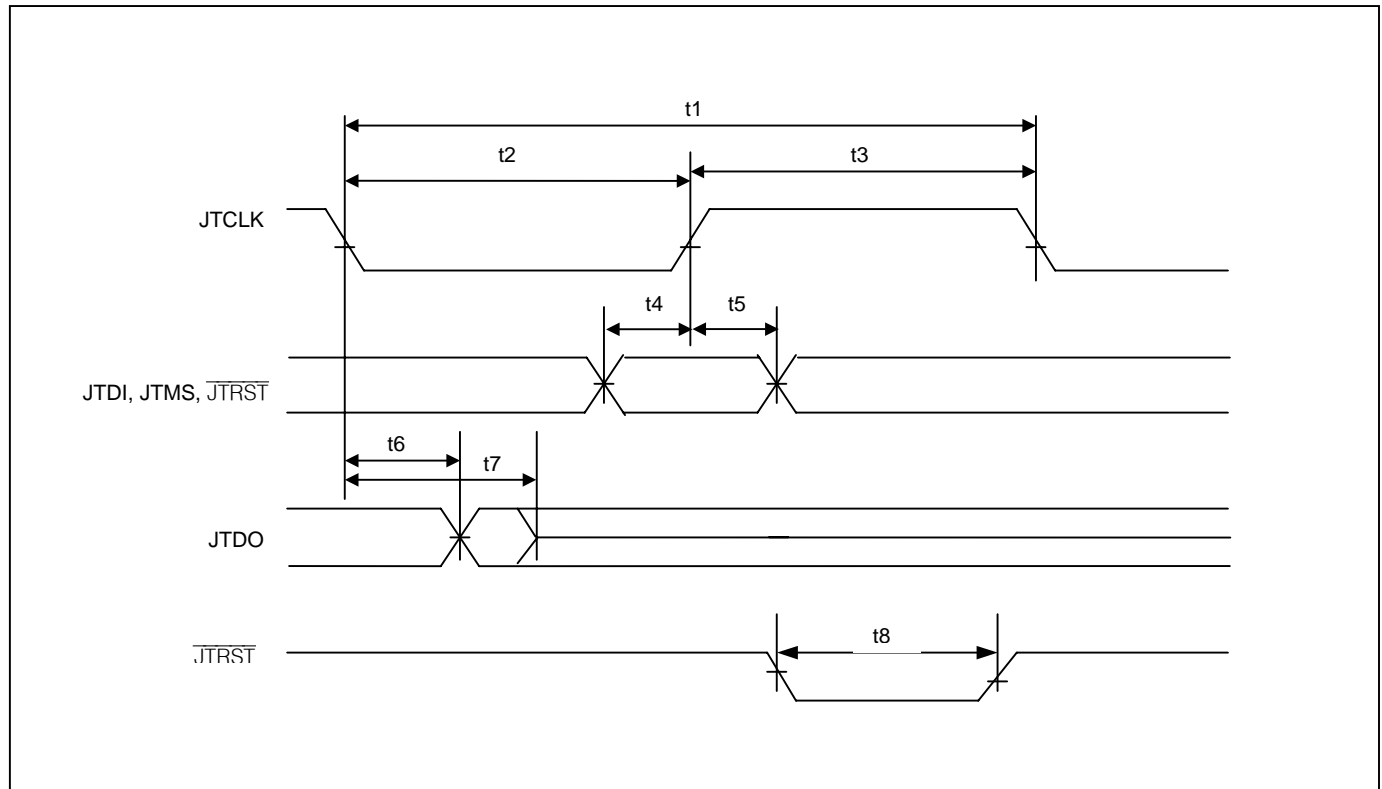

14. PIN ASSIGNMENTS

Table 14-A lists pin assignments sorted by signal name. Table 14-B lists pin assignments sorted by pin number. DS3154 has all four LIUs. DS3153 has only LIUs 1, 2, and 3. DS3152 has only LIUs 1 and 2. DS3151 has only LIU 1. Figure 14-1 through Figure 14-8 show pinouts for the four devices in both hardware and CPU bus modes.

Table 14-A. Pin Assignments Sorted by Signal Name

| NAME | HARDWARE MODE | CPU BUS MODE | PIN | | | |
|--------------------|---------------|--------------|-------|-------|-------|-------|
| | | | LIU 1 | LIU 2 | LIU 3 | LIU 4 |
| A[0] | N | Y | K6 | | | |
| A[1] | N | Y | L6 | | | |
| A[2] | N | Y | K7 | | | |
| A[3] | N | Y | L7 | | | |
| A[4] | N | Y | K8 | | | |
| A[5] | N | Y | L8 | | | |
| ALE | N | Y | C7 | | | |
| \overline{CS} | N | Y | B7 | | | |
| D[0] | N | Y | E3 | | | |
| D[1] | N | Y | F2 | | | |
| D[2] | N | Y | F3 | | | |
| D[3] | N | Y | G2 | | | |
| D[4] | N | Y | G3 | | | |
| D[5] | N | Y | H2 | | | |
| D[6] | N | Y | H3 | | | |
| D[7] | N | Y | J3 | | | |
| E3MCLK | Y | Y | E12 | | | |
| E3Mn | Y | N | F3 | G10 | C7 | K6 |
| \overline{HIZ} | Y | Y | J8 | | | |
| HW | Y | Y | E9 | | | |
| \overline{INT} | N | Y | C5 | | | |
| JTCLK | Y | Y | E4 | | | |
| JTDI | Y | Y | H4 | | | |
| JTDO | Y | Y | J4 | | | |
| JTMS | Y | Y | D5 | | | |
| \overline{JTRST} | Y | Y | D4 | | | |
| LLBn | Y | N | B5 | L8 | E11 | H2 |
| MOT | N | Y | C6 | | | |
| PRBSn | Y | Y | B1 | L12 | A11 | M2 |
| RBIN | Y | N | D9 | | | |
| RCINV | Y | N | J9 | | | |
| RCLKn | Y | Y | C1 | K12 | A10 | M3 |
| \overline{RD} | N | Y | B6 | | | |
| RJAn | Y | N | B4 | L9 | D11 | J2 |
| RLBn | Y | N | C5 | K8 | E10 | H3 |
| \overline{RLOS} | Y | Y | A1 | M12 | A12 | M1 |

Table 14-A. Pin Assignments Sorted by Signal Name (continued)

| NAME | HARDWARE MODE | CPU MODE | PIN | | | |
|--------------------------|---------------|----------|--|-------|-------|-------|
| | | | LIU 1 | LIU 2 | LIU 3 | LIU 4 |
| RNEG _n | Y | Y | C3 | K10 | C10 | K3 |
| RPOS _n | Y | Y | C2 | K11 | B10 | L3 |
| $\overline{\text{RST}}$ | Y | Y | H1 | | | |
| $\overline{\text{RTSn}}$ | Y | Y | B2 | L11 | B11 | L2 |
| RXN _n | Y | Y | A2 | M11 | B12 | L1 |
| RXP _n | Y | Y | A3 | M10 | C12 | K1 |
| STMCLK | Y | Y | M8 | | | |
| STSn | Y | N | F2 | G11 | B7 | L6 |
| T3MCLK | Y | Y | A5 | | | |
| TBIN | Y | N | D8 | | | |
| TCINV | Y | N | H9 | | | |
| TCLK _n | Y | Y | E1 | H12 | A8 | M5 |
| $\overline{\text{TDMn}}$ | Y | Y | D3 | J10 | C9 | K4 |
| TDSAn | Y | N | G2 | F11 | B6 | L7 |
| TDSB _n | Y | N | G3 | F10 | C6 | K7 |
| $\overline{\text{TEST}}$ | Y | Y | J5 | | | |
| TJAn | Y | N | C4 | K9 | D10 | J3 |
| TLBOn | Y | N | E3 | H10 | C8 | K5 |
| TNEG _n | Y | Y | D2 | J11 | B9 | L4 |
| TPOS _n | Y | Y | D1 | J12 | A9 | M4 |
| $\overline{\text{TTSn}}$ | Y | Y | E2 | H11 | B8 | L5 |
| TXN _n | Y | Y | G1 | F12 | A6 | M7 |
| TXP _n | Y | Y | F1 | G12 | A7 | M6 |
| V _{DD} | Y | Y | D6, E5, E6, F4, F5, F6, G7, G8, G9, H7, H8, J7 | | | |
| V _{SS} | Y | Y | D7, E7, E8, F7, F8, F9, G4, G5, G6, H5, H6, J6 | | | |
| $\overline{\text{WR}}$ | N | Y | B5 | | | |

Table 14-B. Pin Assignments Sorted by Pin Number

| PIN | DS3154 | | DS3153 | | DS3152 | | DS3151 | |
|-----|-----------------|-----------------|-----------------|-----------------|-----------------|-----------------|-----------------|-----------------|
| | HARDWARE MODE | CPU BUS MODE | HARDWARE MODE | CPU BUS MODE | HARDWARE MODE | CPU BUS MODE | HARDWARE MODE | CPU BUS MODE |
| A1 | RLOS1 | RLOS1 | RLOS1 | RLOS1 | RLOS1 | RLOS1 | RLOS1 | RLOS1 |
| A2 | RXN1 | RXN1 | RXN1 | RXN1 | RXN1 | RXN1 | RXN1 | RXN1 |
| A3 | RXP1 | RXP1 | RXP1 | RXP1 | RXP1 | RXP1 | RXP1 | RXP1 |
| A4 | RMON1 | N.C. | RMON1 | N.C. | RMON1 | N.C. | RMON1 | N.C. |
| A5 | T3MCLK | T3MCLK | T3MCLK | T3MCLK | T3MCLK | T3MCLK | T3MCLK | T3MCLK |
| A6 | TXN3 | TXN3 | TXN3 | TXN3 | N.C. | N.C. | N.C. | N.C. |
| A7 | TXP3 | TXP3 | TXP3 | TXP3 | N.C. | N.C. | N.C. | N.C. |
| A8 | TCLK3 | TCLK3 | TCLK3 | TCLK3 | N.C. | N.C. | N.C. | N.C. |
| A9 | TPOS3 | TPOS3 | TPOS3 | TPOS3 | N.C. | N.C. | N.C. | N.C. |
| A10 | RCLK3 | RCLK3 | RCLK3 | RCLK3 | N.C. | N.C. | N.C. | N.C. |
| A11 | PRBS3 | PRBS3 | PRBS3 | PRBS3 | N.C. | N.C. | N.C. | N.C. |
| A12 | RLOS3 | RLOS3 | RLOS3 | RLOS3 | N.C. | N.C. | N.C. | N.C. |
| B1 | PRBS1 | PRBS1 | PRBS1 | PRBS1 | PRBS1 | PRBS1 | PRBS1 | PRBS1 |
| B2 | RTS1 | RTS1 | RTS1 | RTS1 | RTS1 | RTS1 | RTS1 | RTS1 |
| B3 | N.C. | N.C. | N.C. | N.C. | N.C. | N.C. | N.C. | N.C. |
| B4 | RJA1 | N.C. | RJA1 | N.C. | RJA1 | N.C. | RJA1 | N.C. |
| B5 | LLB1 | WR | LLB1 | WR | LLB1 | WR | LLB1 | WR |
| B6 | TDSA3 | RD | TDSA3 | RD | N.C. | RD | N.C. | RD |
| B7 | STS3 | CS | STS3 | CS | N.C. | CS | N.C. | CS |
| B8 | TTS3 | TTS3 | TTS3 | TTS3 | N.C. | N.C. | N.C. | N.C. |
| B9 | TNEG3 | TNEG3 | TNEG3 | TNEG3 | N.C. | N.C. | N.C. | N.C. |
| B10 | RPOS3 | RPOS3 | RPOS3 | RPOS3 | N.C. | N.C. | N.C. | N.C. |
| B11 | RTS3 | RTS3 | RTS3 | RTS3 | N.C. | N.C. | N.C. | N.C. |
| B12 | RXN3 | RXN3 | RXN3 | RXN3 | N.C. | N.C. | N.C. | N.C. |
| C1 | RCLK1 | RCLK1 | RCLK1 | RCLK1 | RCLK1 | RCLK1 | RCLK1 | RCLK1 |
| C2 | RPOS1 | RPOS1 | RPOS1 | RPOS1 | RPOS1 | RPOS1 | RPOS1 | RPOS1 |
| C3 | RNEG1 | RNEG1 | RNEG1 | RNEG1 | RNEG1 | RNEG1 | RNEG1 | RNEG1 |
| C4 | TJA1 | N.C. | TJA1 | N.C. | TJA1 | N.C. | TJA1 | N.C. |
| C5 | RLB1 | INT | RLB1 | INT | RLB1 | INT | RLB1 | INT |
| C6 | TDSB3 | MOT | TDSB3 | MOT | N.C. | MOT | N.C. | MOT |
| C7 | E3M3 | ALE | E3M3 | ALE | N.C. | ALE | N.C. | ALE |
| C8 | TLBO3 | N.C. | TLBO3 | N.C. | N.C. | N.C. | N.C. | N.C. |
| C9 | TDM3 | TDM3 | TDM3 | TDM3 | N.C. | N.C. | N.C. | N.C. |
| C10 | RNEG3 | RNEG3 | RNEG3 | RNEG3 | N.C. | N.C. | N.C. | N.C. |
| C11 | N.C. | N.C. | N.C. | N.C. | N.C. | N.C. | N.C. | N.C. |
| C12 | RXP3 | RXP3 | RXP3 | RXP3 | N.C. | N.C. | N.C. | N.C. |
| D1 | TPOS1 | TPOS1 | TPOS1 | TPOS1 | TPOS1 | TPOS1 | TPOS1 | TPOS1 |
| D2 | TNEG1 | TNEG1 | TNEG1 | TNEG1 | TNEG1 | TNEG1 | TNEG1 | TNEG1 |
| D3 | TDM1 | TDM1 | TDM1 | TDM1 | TDM1 | TDM1 | TDM1 | TDM1 |
| D4 | JTRST | JTRST | JTRST | JTRST | JTRST | JTRST | JTRST | JTRST |
| D5 | JTMS | JTMS | JTMS | JTMS | JTMS | JTMS | JTMS | JTMS |
| D6 | V _{DD} | V _{DD} | V _{DD} | V _{DD} | V _{DD} | V _{DD} | V _{DD} | V _{DD} |
| D7 | V _{SS} | V _{SS} | V _{SS} | V _{SS} | V _{SS} | V _{SS} | V _{SS} | V _{SS} |
| D8 | TBIN | N.C. | TBIN | N.C. | TBIN | N.C. | TBIN | N.C. |
| D9 | RBIN | N.C. | RBIN | N.C. | RBIN | N.C. | RBIN | N.C. |
| D10 | TJA3 | N.C. | TJA3 | N.C. | N.C. | N.C. | N.C. | N.C. |
| D11 | RJA3 | N.C. | RJA3 | N.C. | N.C. | N.C. | N.C. | N.C. |
| D12 | RMON3 | N.C. | RMON3 | N.C. | N.C. | N.C. | N.C. | N.C. |
| E1 | TCLK1 | TCLK1 | TCLK1 | TCLK1 | TCLK1 | TCLK1 | TCLK1 | TCLK1 |
| E2 | TTS1 | TTS1 | TTS1 | TTS1 | TTS1 | TTS1 | TTS1 | TTS1 |
| E3 | TLBO1 | D0 | TLBO1 | D0 | TLBO1 | D0 | TLBO1 | D0 |
| E4 | JTCLK | JTCLK | JTCLK | JTCLK | JTCLK | JTCLK | JTCLK | JTCLK |
| E5 | V _{DD} | V _{DD} | V _{DD} | V _{DD} | V _{DD} | V _{DD} | V _{DD} | V _{DD} |
| E6 | V _{DD} | V _{DD} | V _{DD} | V _{DD} | V _{DD} | V _{DD} | V _{DD} | V _{DD} |
| E7 | V _{SS} | V _{SS} | V _{SS} | V _{SS} | V _{SS} | V _{SS} | V _{SS} | V _{SS} |
| E8 | V _{SS} | V _{SS} | V _{SS} | V _{SS} | V _{SS} | V _{SS} | V _{SS} | V _{SS} |
| E9 | HW | HW | HW | HW | HW | HW | HW | HW |

| PIN | DS3154 | | DS3153 | | DS3152 | | DS3151 | |
|-----|--------------------------|--------------------------|--------------------------|--------------------------|--------------------------|--------------------------|--------------------------|--------------------------|
| | HARDWARE MODE | CPU BUS MODE | HARDWARE MODE | CPU BUS MODE | HARDWARE MODE | CPU BUS MODE | HARDWARE MODE | CPU BUS MODE |
| E10 | RLB3 | N.C. | RLB3 | N.C. | N.C. | N.C. | N.C. | N.C. |
| E11 | LLB3 | N.C. | LLB3 | N.C. | N.C. | N.C. | N.C. | N.C. |
| E12 | E3MCLK | E3MCLK | E3MCLK | E3MCLK | E3MCLK | E3MCLK | E3MCLK | E3MCLK |
| F1 | TXP1 | TXP1 | TXP1 | TXP1 | TXP1 | TXP1 | TXP1 | TXP1 |
| F2 | STS1 | D1 | STS1 | D1 | STS1 | D1 | STS1 | D1 |
| F3 | E3M1 | D2 | E3M1 | D2 | E3M1 | D2 | E3M1 | D2 |
| F4 | V _{DD} | V _{DD} | V _{DD} | V _{DD} | V _{DD} | V _{DD} | V _{DD} | V _{DD} |
| F5 | V _{DD} | V _{DD} | V _{DD} | V _{DD} | V _{DD} | V _{DD} | V _{DD} | V _{DD} |
| F6 | V _{DD} | V _{DD} | V _{DD} | V _{DD} | V _{DD} | V _{DD} | V _{DD} | V _{DD} |
| F7 | V _{SS} | V _{SS} | V _{SS} | V _{SS} | V _{SS} | V _{SS} | V _{SS} | V _{SS} |
| F8 | V _{SS} | V _{SS} | V _{SS} | V _{SS} | V _{SS} | V _{SS} | V _{SS} | V _{SS} |
| F9 | V _{SS} | V _{SS} | V _{SS} | V _{SS} | V _{SS} | V _{SS} | V _{SS} | V _{SS} |
| F10 | TDSB2 | N.C. | TDSB2 | N.C. | TDSB2 | N.C. | N.C. | N.C. |
| F11 | TDSA2 | N.C. | TDSA2 | N.C. | TDSA2 | N.C. | N.C. | N.C. |
| F12 | TXN2 | TXN2 | TXN2 | TXN2 | TXN2 | TXN2 | N.C. | N.C. |
| G1 | TXN1 | TXN1 | TXN1 | TXN1 | TXN1 | TXN1 | TXN1 | TXN1 |
| G2 | TDSA1 | D3 | TDSA1 | D3 | TDSA1 | D3 | TDSA1 | D3 |
| G3 | TDSB1 | D4 | TDSB1 | D4 | TDSB1 | D4 | TDSB1 | D4 |
| G4 | V _{SS} | V _{SS} | V _{SS} | V _{SS} | V _{SS} | V _{SS} | V _{SS} | V _{SS} |
| G5 | V _{SS} | V _{SS} | V _{SS} | V _{SS} | V _{SS} | V _{SS} | V _{SS} | V _{SS} |
| G6 | V _{SS} | V _{SS} | V _{SS} | V _{SS} | V _{SS} | V _{SS} | V _{SS} | V _{SS} |
| G7 | V _{DD} | V _{DD} | V _{DD} | V _{DD} | V _{DD} | V _{DD} | V _{DD} | V _{DD} |
| G8 | V _{DD} | V _{DD} | V _{DD} | V _{DD} | V _{DD} | V _{DD} | V _{DD} | V _{DD} |
| G9 | V _{DD} | V _{DD} | V _{DD} | V _{DD} | V _{DD} | V _{DD} | V _{DD} | V _{DD} |
| G10 | E3M2 | N.C. | E3M2 | N.C. | E3M2 | N.C. | N.C. | N.C. |
| G11 | STS2 | N.C. | STS2 | N.C. | STS2 | N.C. | N.C. | N.C. |
| G12 | TXP2 | TXP2 | TXP2 | TXP2 | TXP2 | TXP2 | N.C. | N.C. |
| H1 | RST | RST | RST | RST | RST | RST | RST | RST |
| H2 | LLB4 | D5 | N.C. | D5 | N.C. | D5 | N.C. | D5 |
| H3 | RLB4 | D6 | N.C. | D6 | N.C. | D6 | N.C. | D6 |
| H4 | JTDI | JTDI | JTDI | JTDI | JTDI | JTDI | JTDI | JTDI |
| H5 | V _{SS} | V _{SS} | V _{SS} | V _{SS} | V _{SS} | V _{SS} | V _{SS} | V _{SS} |
| H6 | V _{SS} | V _{SS} | V _{SS} | V _{SS} | V _{SS} | V _{SS} | V _{SS} | V _{SS} |
| H7 | V _{DD} | V _{DD} | V _{DD} | V _{DD} | V _{DD} | V _{DD} | V _{DD} | V _{DD} |
| H8 | V _{DD} | V _{DD} | V _{DD} | V _{DD} | V _{DD} | V _{DD} | V _{DD} | V _{DD} |
| H9 | TCINV | N.C. | TCINV | N.C. | TCINV | N.C. | TCINV | N.C. |
| H10 | TLBO2 | N.C. | TLBO2 | N.C. | TLBO2 | N.C. | N.C. | N.C. |
| H11 | $\overline{\text{TTS2}}$ | $\overline{\text{TTS2}}$ | $\overline{\text{TTS2}}$ | $\overline{\text{TTS2}}$ | $\overline{\text{TTS2}}$ | $\overline{\text{TTS2}}$ | N.C. | N.C. |
| H12 | TCLK2 | TCLK2 | TCLK2 | TCLK2 | TCLK2 | TCLK2 | N.C. | N.C. |
| J1 | RMON4 | N.C. | N.C. | N.C. | N.C. | N.C. | N.C. | N.C. |
| J2 | RJA4 | N.C. | N.C. | N.C. | N.C. | N.C. | N.C. | N.C. |
| J3 | TJA4 | D7 | N.C. | D7 | N.C. | D7 | N.C. | D7 |
| J4 | JTDO | JTDO | JTDO | JTDO | JTDO | JTDO | JTDO | JTDO |
| J5 | $\overline{\text{TEST}}$ | $\overline{\text{TEST}}$ | $\overline{\text{TEST}}$ | $\overline{\text{TEST}}$ | $\overline{\text{TEST}}$ | $\overline{\text{TEST}}$ | $\overline{\text{TEST}}$ | $\overline{\text{TEST}}$ |
| J6 | V _{SS} | V _{SS} | V _{SS} | V _{SS} | V _{SS} | V _{SS} | V _{SS} | V _{SS} |
| J7 | V _{DD} | V _{DD} | V _{DD} | V _{DD} | V _{DD} | V _{DD} | V _{DD} | V _{DD} |
| J8 | HIZ | HIZ | HIZ | HIZ | HIZ | HIZ | HIZ | HIZ |
| J9 | RCINV | N.C. | RCINV | N.C. | RCINV | N.C. | RCINV | N.C. |
| J10 | $\overline{\text{TDM2}}$ | $\overline{\text{TDM2}}$ | $\overline{\text{TDM2}}$ | $\overline{\text{TDM2}}$ | $\overline{\text{TDM2}}$ | $\overline{\text{TDM2}}$ | N.C. | N.C. |
| J11 | TNEG2 | TNEG2 | TNEG2 | TNEG2 | TNEG2 | TNEG2 | N.C. | N.C. |
| J12 | TPOS2 | TPOS2 | TPOS2 | TPOS2 | TPOS2 | TPOS2 | N.C. | N.C. |
| K1 | RXP4 | RXP4 | N.C. | N.C. | N.C. | N.C. | N.C. | N.C. |
| K2 | N.C. | N.C. | N.C. | N.C. | N.C. | N.C. | N.C. | N.C. |
| K3 | RNEG4 | RNEG4 | N.C. | N.C. | N.C. | N.C. | N.C. | N.C. |
| K4 | $\overline{\text{TDM4}}$ | $\overline{\text{TDM4}}$ | N.C. | N.C. | N.C. | N.C. | N.C. | N.C. |
| K5 | TLBO4 | N.C. | N.C. | N.C. | N.C. | N.C. | N.C. | N.C. |
| K6 | E3M4 | A0 | N.C. | A0 | N.C. | A0 | N.C. | A0 |
| K7 | TDSB4 | A2 | N.C. | A2 | N.C. | A2 | N.C. | A2 |
| K8 | RLB2 | A4 | RLB2 | A4 | RLB2 | A4 | N.C. | N.C. |

| PIN | DS3154 | | DS3153 | | DS3152 | | DS3151 | |
|-----|---------------|--------------|---------------|--------------|---------------|--------------|---------------|--------------|
| | HARDWARE MODE | CPU BUS MODE | HARDWARE MODE | CPU BUS MODE | HARDWARE MODE | CPU BUS MODE | HARDWARE MODE | CPU BUS MODE |
| K9 | TJA2 | N.C. | TJA2 | N.C. | TJA2 | N.C. | N.C. | N.C. |
| K10 | RNEG2 | RNEG2 | RNEG2 | RNEG2 | RNEG2 | RNEG2 | N.C. | N.C. |
| K11 | RPOS2 | RPOS2 | RPOS2 | RPOS2 | RPOS2 | RPOS2 | N.C. | N.C. |
| K12 | RCLK2 | RCLK2 | RCLK2 | RCLK2 | RCLK2 | RCLK2 | N.C. | N.C. |
| L1 | RXN4 | RXN4 | N.C. | N.C. | N.C. | N.C. | N.C. | N.C. |
| L2 | RTS4 | RTS4 | N.C. | N.C. | N.C. | N.C. | N.C. | N.C. |
| L3 | RPOS4 | RPOS4 | N.C. | N.C. | N.C. | N.C. | N.C. | N.C. |
| L4 | TNEG4 | TNEG4 | N.C. | N.C. | N.C. | N.C. | N.C. | N.C. |
| L5 | TTS4 | TTS4 | N.C. | N.C. | N.C. | N.C. | N.C. | N.C. |
| L6 | STS4 | A1 | N.C. | A1 | N.C. | A1 | N.C. | A1 |
| L7 | TDSA4 | A3 | N.C. | A3 | N.C. | A3 | N.C. | A3 |
| L8 | LLB2 | A5 | LLB2 | A5 | LLB2 | N.C. | N.C. | N.C. |
| L9 | RJA2 | N.C. | RJA2 | N.C. | RJA2 | N.C. | N.C. | N.C. |
| L10 | N.C. | N.C. | N.C. | N.C. | N.C. | N.C. | N.C. | N.C. |
| L11 | RTS2 | RTS2 | RTS2 | RTS2 | RTS2 | RTS2 | N.C. | N.C. |
| L12 | PRBS2 | PRBS2 | PRBS2 | PRBS2 | PRBS2 | PRBS2 | N.C. | N.C. |
| M1 | RLOS4 | RLOS4 | N.C. | N.C. | N.C. | N.C. | N.C. | N.C. |
| M2 | PRBS4 | PRBS4 | N.C. | N.C. | N.C. | N.C. | N.C. | N.C. |
| M3 | RCLK4 | RCLK4 | N.C. | N.C. | N.C. | N.C. | N.C. | N.C. |
| M4 | TPOS4 | TPOS4 | N.C. | N.C. | N.C. | N.C. | N.C. | N.C. |
| M5 | TCLK4 | TCLK4 | N.C. | N.C. | N.C. | N.C. | N.C. | N.C. |
| M6 | TXP4 | TXP4 | N.C. | N.C. | N.C. | N.C. | N.C. | N.C. |
| M7 | TXN4 | TXN4 | N.C. | N.C. | N.C. | N.C. | N.C. | N.C. |
| M8 | STMCLK | STMCLK | STMCLK | STMCLK | STMCLK | STMCLK | STMCLK | STMCLK |
| M9 | RMON2 | N.C. | RMON2 | N.C. | RMON2 | N.C. | N.C. | N.C. |
| M10 | RXP2 | RXP2 | RXP2 | RXP2 | RXP2 | RXP2 | N.C. | N.C. |
| M11 | RXN2 | RXN2 | RXN2 | RXN2 | RXN2 | RXN2 | N.C. | N.C. |
| M12 | RLOS2 | RLOS2 | RLOS2 | RLOS2 | RLOS2 | RLOS2 | N.C. | N.C. |

Figure 14-1. DS3151 Hardware Mode Pin Assignment

| | | | | | | | | | | | |
|-------|-------|-------|-----------------|-----------------|-----------------|-----------------|-----------------|-----------------|------|------|--------|
| A1 | A2 | A3 | A4 | A5 | A6 | A7 | A8 | A9 | A10 | A11 | A12 |
| RLOS1 | RXN1 | RXP1 | RMON1 | T3MCLK | N.C. | N.C. | N.C. | N.C. | N.C. | N.C. | N.C. |
| B1 | B2 | B3 | B4 | B5 | B6 | B7 | B8 | B9 | B10 | B11 | B12 |
| PRBS1 | RTS1 | N.C. | RJA1 | LLB1 | N.C. | N.C. | N.C. | N.C. | N.C. | N.C. | N.C. |
| C1 | C2 | C3 | C4 | C5 | C6 | C7 | C8 | C9 | C10 | C11 | C12 |
| RCLK1 | RPOS1 | RNEG1 | TJA1 | RLB1 | N.C. | N.C. | N.C. | N.C. | N.C. | N.C. | N.C. |
| D1 | D2 | D3 | D4 | D5 | D6 | D7 | D8 | D9 | D10 | D11 | D12 |
| TPOS1 | TNEG1 | TDM1 | JTRST | JTMS | V _{DD} | V _{SS} | TBIN | RBIN | N.C. | N.C. | N.C. |
| E1 | E2 | E3 | E4 | E5 | E6 | E7 | E8 | E9 | E10 | E11 | E12 |
| TCLK1 | TTS1 | TLBO1 | JTCLK | V _{DD} | V _{DD} | V _{SS} | V _{SS} | HW | N.C. | N.C. | E3MCLK |
| F1 | F2 | F3 | F4 | F5 | F6 | F7 | F8 | F9 | F10 | F11 | F12 |
| TXP1 | STS1 | E3M1 | V _{DD} | V _{DD} | V _{DD} | V _{SS} | V _{SS} | V _{SS} | N.C. | N.C. | N.C. |
| G1 | G2 | G3 | G4 | G5 | G6 | G7 | G8 | G9 | G10 | G11 | G12 |
| TXN1 | TDSA1 | TDSB1 | V _{SS} | V _{SS} | V _{SS} | V _{DD} | V _{DD} | V _{DD} | N.C. | N.C. | N.C. |
| H1 | H2 | H3 | H4 | H5 | H6 | H7 | H8 | H9 | H10 | H11 | H12 |
| RST | N.C. | N.C. | JTDI | V _{SS} | V _{SS} | V _{DD} | V _{DD} | TCINV | N.C. | N.C. | N.C. |
| J1 | J2 | J3 | J4 | J5 | J6 | J7 | J8 | J9 | J10 | J11 | J12 |
| N.C. | N.C. | N.C. | JTDO | TEST | V _{SS} | V _{DD} | HIZ | RCINV | N.C. | N.C. | N.C. |
| K1 | K2 | K3 | K4 | K5 | K6 | K7 | K8 | K9 | K10 | K11 | K12 |
| N.C. | N.C. | N.C. | N.C. | N.C. | N.C. | N.C. | N.C. | N.C. | N.C. | N.C. | N.C. |
| L1 | L2 | L3 | L4 | L5 | L6 | L7 | L8 | L9 | L10 | L11 | L12 |
| N.C. | N.C. | N.C. | N.C. | N.C. | N.C. | N.C. | N.C. | N.C. | N.C. | N.C. | N.C. |
| M1 | M2 | M3 | M4 | M5 | M6 | M7 | M8 | M9 | M10 | M11 | M12 |
| N.C. | N.C. | N.C. | N.C. | N.C. | N.C. | N.C. | STMCLK | N.C. | N.C. | N.C. | N.C. |





-  High-Speed Analog
-  High-Speed Digital
-  Low-Speed Digital
-  V_{DD}
-  V_{SS}

Figure 14-2. DS3151 CPU Bus Mode Pin Assignment

| | | | | | | | | | | | |
|---------------------------|--------------------------|--------------------------|---------------------------|--------------------------|------------------------|------------------------|-------------------------|-----------------|------|------|--------|
| A1 | A2 | A3 | A4 | A5 | A6 | A7 | A8 | A9 | A10 | A11 | A12 |
| $\overline{\text{RLOS1}}$ | RXN1 | RXP1 | N.C. | T3MCLK | N.C. | N.C. | N.C. | N.C. | N.C. | N.C. | N.C. |
| B1 | B2 | B3 | B4 | B5 | B6 | B7 | B8 | B9 | B10 | B11 | B12 |
| PRBS1 | $\overline{\text{RTS1}}$ | N.C. | N.C. | $\overline{\text{WR}}$ | $\overline{\text{RD}}$ | $\overline{\text{CS}}$ | N.C. | N.C. | N.C. | N.C. | N.C. |
| C1 | C2 | C3 | C4 | C5 | C6 | C7 | C8 | C9 | C10 | C11 | C12 |
| RCLK1 | RPOS1 | RNEG1 | N.C. | $\overline{\text{INT}}$ | MOT | ALE | N.C. | N.C. | N.C. | N.C. | N.C. |
| D1 | D2 | D3 | D4 | D5 | D6 | D7 | D8 | D9 | D10 | D11 | D12 |
| TPOS1 | TNEG1 | $\overline{\text{TDM1}}$ | $\overline{\text{JTRST}}$ | JTMS | V _{DD} | V _{SS} | N.C. | N.C. | N.C. | N.C. | N.C. |
| E1 | E2 | E3 | E4 | E5 | E6 | E7 | E8 | E9 | E10 | E11 | E12 |
| TCLK1 | $\overline{\text{TTS1}}$ | D0 | JTCLK | V _{DD} | V _{DD} | V _{SS} | V _{SS} | HW | N.C. | N.C. | E3MCLK |
| F1 | F2 | F3 | F4 | F5 | F6 | F7 | F8 | F9 | F10 | F11 | F12 |
| TXP1 | D1 | D2 | V _{DD} | V _{DD} | V _{DD} | V _{SS} | V _{SS} | V _{SS} | N.C. | N.C. | N.C. |
| G1 | G2 | G3 | G4 | G5 | G6 | G7 | G8 | G9 | G10 | G11 | G12 |
| TXN1 | D3 | D4 | V _{SS} | V _{SS} | V _{SS} | V _{DD} | V _{DD} | V _{DD} | N.C. | N.C. | N.C. |
| H1 | H2 | H3 | H4 | H5 | H6 | H7 | H8 | H9 | H10 | H11 | H12 |
| $\overline{\text{RST}}$ | D5 | D6 | JTDI | V _{SS} | V _{SS} | V _{DD} | V _{DD} | N.C. | N.C. | N.C. | N.C. |
| J1 | J2 | J3 | J4 | J5 | J6 | J7 | J8 | J9 | J10 | J11 | J12 |
| N.C. | N.C. | D7 | JTDO | $\overline{\text{TEST}}$ | V _{SS} | V _{DD} | $\overline{\text{HIZ}}$ | N.C. | N.C. | N.C. | N.C. |
| K1 | K2 | K3 | K4 | K5 | K6 | K7 | K8 | K9 | K10 | K11 | K12 |
| N.C. | N.C. | N.C. | N.C. | N.C. | A0 | A2 | N.C. | N.C. | N.C. | N.C. | N.C. |
| L1 | L2 | L3 | L4 | L5 | L6 | L7 | L8 | L9 | L10 | L11 | L12 |
| N.C. | N.C. | N.C. | N.C. | N.C. | A1 | A3 | N.C. | N.C. | N.C. | N.C. | N.C. |
| M1 | M2 | M3 | M4 | M5 | M6 | M7 | M8 | M9 | M10 | M11 | M12 |
| N.C. | N.C. | N.C. | N.C. | N.C. | N.C. | N.C. | STMCLK | N.C. | N.C. | N.C. | N.C. |





-  High-Speed Analog
-  High-Speed Digital
-  Low-Speed Digital
-  V_{DD}
-  V_{SS}

Figure 14-3. DS3152 Hardware Mode Pin Assignment

| | | | | | | | | | | | |
|-------|-------|-------|-----------------|-----------------|-----------------|-----------------|-----------------|-----------------|-------|-------|--------|
| A1 | A2 | A3 | A4 | A5 | A6 | A7 | A8 | A9 | A10 | A11 | A12 |
| RLOS1 | RXN1 | RXP1 | RMON1 | T3MCLK | N.C. | N.C. | N.C. | N.C. | N.C. | N.C. | N.C. |
| B1 | B2 | B3 | B4 | B5 | B6 | B7 | B8 | B9 | B10 | B11 | B12 |
| PRBS1 | RTS1 | N.C. | RJA1 | LLB1 | N.C. | N.C. | N.C. | N.C. | N.C. | N.C. | N.C. |
| C1 | C2 | C3 | C4 | C5 | C6 | C7 | C8 | C9 | C10 | C11 | C12 |
| RCLK1 | RPOS1 | RNEG1 | TJA1 | RLB1 | N.C. | N.C. | N.C. | N.C. | N.C. | N.C. | N.C. |
| D1 | D2 | D3 | D4 | D5 | D6 | D7 | D8 | D9 | D10 | D11 | D12 |
| TPOS1 | TNEG1 | TDM1 | JTRST | JTMS | V _{DD} | V _{SS} | TBIN | RBIN | N.C. | N.C. | N.C. |
| E1 | E2 | E3 | E4 | E5 | E6 | E7 | E8 | E9 | E10 | E11 | E12 |
| TCLK1 | TTS1 | TLBO1 | JTCLK | V _{DD} | V _{DD} | V _{SS} | V _{SS} | HW | N.C. | N.C. | E3MCLK |
| F1 | F2 | F3 | F4 | F5 | F6 | F7 | F8 | F9 | F10 | F11 | F12 |
| TXP1 | STS1 | E3M1 | V _{DD} | V _{DD} | V _{DD} | V _{SS} | V _{SS} | V _{SS} | TDSB2 | TDSA2 | TXN2 |
| G1 | G2 | G3 | G4 | G5 | G6 | G7 | G8 | G9 | G10 | G11 | G12 |
| TXN1 | TDSA1 | TDSB1 | V _{SS} | V _{SS} | V _{SS} | V _{DD} | V _{DD} | V _{DD} | E3M2 | STS2 | TXP2 |
| H1 | H2 | H3 | H4 | H5 | H6 | H7 | H8 | H9 | H10 | H11 | H12 |
| RST | N.C. | N.C. | JTDI | V _{SS} | V _{SS} | V _{DD} | V _{DD} | TCINV | TLBO2 | TTS2 | TCLK2 |
| J1 | J2 | J3 | J4 | J5 | J6 | J7 | J8 | J9 | J10 | J11 | J12 |
| N.C. | N.C. | N.C. | JTDO | TEST | V _{SS} | V _{DD} | HIZ | RCINV | TDM2 | TNEG2 | TPOS2 |
| K1 | K2 | K3 | K4 | K5 | K6 | K7 | K8 | K9 | K10 | K11 | K12 |
| N.C. | N.C. | N.C. | N.C. | N.C. | N.C. | N.C. | RLB2 | TJA2 | RNEG2 | RPOS2 | RCLK2 |
| L1 | L2 | L3 | L4 | L5 | L6 | L7 | L8 | L9 | L10 | L11 | L12 |
| N.C. | N.C. | N.C. | N.C. | N.C. | N.C. | N.C. | LLB2 | RJA2 | N.C. | RTS2 | PRBS2 |
| M1 | M2 | M3 | M4 | M5 | M6 | M7 | M8 | M9 | M10 | M11 | M12 |
| N.C. | N.C. | N.C. | N.C. | N.C. | N.C. | N.C. | STMCLK | RMON2 | RXP2 | RXN2 | RLOS2 |





-  High-Speed Analog
-  High-Speed Digital
-  Low-Speed Digital
-  V_{DD}
-  V_{SS}

Figure 14-4. DS3152 CPU Bus Mode Pin Assignment

| | | | | | | | | | | | |
|---------------------------|--------------------------|--------------------------|---------------------------|--------------------------|------------------------|------------------------|-------------------------|-----------------|--------------------------|--------------------------|---------------------------|
| A1 | A2 | A3 | A4 | A5 | A6 | A7 | A8 | A9 | A10 | A11 | A12 |
| $\overline{\text{RLOS1}}$ | RXN1 | RXP1 | N.C. | T3MCLK | N.C. | N.C. | N.C. | N.C. | N.C. | N.C. | N.C. |
| B1 | B2 | B3 | B4 | B5 | B6 | B7 | B8 | B9 | B10 | B11 | B12 |
| PRBS1 | $\overline{\text{RTS1}}$ | N.C. | N.C. | $\overline{\text{WR}}$ | $\overline{\text{RD}}$ | $\overline{\text{CS}}$ | N.C. | N.C. | N.C. | N.C. | N.C. |
| C1 | C2 | C3 | C4 | C5 | C6 | C7 | C8 | C9 | C10 | C11 | C12 |
| RCLK1 | RPOS1 | RNEG1 | N.C. | $\overline{\text{INT}}$ | MOT | ALE | N.C. | N.C. | N.C. | N.C. | N.C. |
| D1 | D2 | D3 | D4 | D5 | D6 | D7 | D8 | D9 | D10 | D11 | D12 |
| TPOS1 | TNEG1 | $\overline{\text{TDM1}}$ | $\overline{\text{JTRST}}$ | JTMS | V _{DD} | V _{SS} | N.C. | N.C. | N.C. | N.C. | N.C. |
| E1 | E2 | E3 | E4 | E5 | E6 | E7 | E8 | E9 | E10 | E11 | E12 |
| TCLK1 | $\overline{\text{TTS1}}$ | D0 | JTCLK | V _{DD} | V _{DD} | V _{SS} | V _{SS} | HW | N.C. | N.C. | E3MCLK |
| F1 | F2 | F3 | F4 | F5 | F6 | F7 | F8 | F9 | F10 | F11 | F12 |
| TXP1 | D1 | D2 | V _{DD} | V _{DD} | V _{DD} | V _{SS} | V _{SS} | V _{SS} | N.C. | N.C. | TXN2 |
| G1 | G2 | G3 | G4 | G5 | G6 | G7 | G8 | G9 | G10 | G11 | G12 |
| TXN1 | D3 | D4 | V _{SS} | V _{SS} | V _{SS} | V _{DD} | V _{DD} | V _{DD} | N.C. | N.C. | TXP2 |
| H1 | H2 | H3 | H4 | H5 | H6 | H7 | H8 | H9 | H10 | H11 | H12 |
| $\overline{\text{RST}}$ | D5 | D6 | JTDI | V _{SS} | V _{SS} | V _{DD} | V _{DD} | N.C. | N.C. | $\overline{\text{TTS2}}$ | TCLK2 |
| J1 | J2 | J3 | J4 | J5 | J6 | J7 | J8 | J9 | J10 | J11 | J12 |
| N.C. | N.C. | D7 | JTDO | $\overline{\text{TEST}}$ | V _{SS} | V _{DD} | $\overline{\text{HIZ}}$ | N.C. | $\overline{\text{TDM2}}$ | TNEG2 | TPOS2 |
| K1 | K2 | K3 | K4 | K5 | K6 | K7 | K8 | K9 | K10 | K11 | K12 |
| N.C. | N.C. | N.C. | N.C. | N.C. | A0 | A2 | A4 | N.C. | RNEG2 | RPOS2 | RCLK2 |
| L1 | L2 | L3 | L4 | L5 | L6 | L7 | L8 | L9 | L10 | L11 | L12 |
| N.C. | N.C. | N.C. | N.C. | N.C. | A1 | A3 | N.C. | N.C. | N.C. | $\overline{\text{RTS2}}$ | PRBS2 |
| M1 | M2 | M3 | M4 | M5 | M6 | M7 | M8 | M9 | M10 | M11 | M12 |
| N.C. | N.C. | N.C. | N.C. | N.C. | N.C. | N.C. | STMCLK | N.C. | RXP2 | RXN2 | $\overline{\text{RLOS2}}$ |





-  High-Speed Analog
-  High-Speed Digital
-  Low-Speed Digital
-  V_{DD}
-  V_{SS}

Figure 14-5. DS3153 Hardware Mode Pin Assignment

| | | | | | | | | | | | |
|-------|-------|-------|-----------------|-----------------|-----------------|-----------------|-----------------|-----------------|-------|-------|--------|
| A1 | A2 | A3 | A4 | A5 | A6 | A7 | A8 | A9 | A10 | A11 | A12 |
| RLOS1 | RXN1 | RXP1 | RMON1 | T3MCLK | TXN3 | TXP3 | TCLK3 | TPOS3 | RCLK3 | PRBS3 | RLOS3 |
| B1 | B2 | B3 | B4 | B5 | B6 | B7 | B8 | B9 | B10 | B11 | B12 |
| PRBS1 | RTS1 | N.C. | RJA1 | LLB1 | TDSA3 | STS3 | TTS3 | TNEG3 | RPOS3 | RTS3 | RXN3 |
| C1 | C2 | C3 | C4 | C5 | C6 | C7 | C8 | C9 | C10 | C11 | C12 |
| RCLK1 | RPOS1 | RNEG1 | TJA1 | RLB1 | TDSB3 | E3M3 | TLBO3 | TDM3 | RNEG3 | N.C. | RXP3 |
| D1 | D2 | D3 | D4 | D5 | D6 | D7 | D8 | D9 | D10 | D11 | D12 |
| TPOS1 | TNEG1 | TDM1 | JTRST | JTMS | V _{DD} | V _{SS} | TBIN | RBIN | TJA3 | RJA3 | RMON3 |
| E1 | E2 | E3 | E4 | E5 | E6 | E7 | E8 | E9 | E10 | E11 | E12 |
| TCLK1 | TTS1 | TLBO1 | JTCLK | V _{DD} | V _{DD} | V _{SS} | V _{SS} | HW | RLB3 | LLB3 | E3MCLK |
| F1 | F2 | F3 | F4 | F5 | F6 | F7 | F8 | F9 | F10 | F11 | F12 |
| TXP1 | STS1 | E3M1 | V _{DD} | V _{DD} | V _{DD} | V _{SS} | V _{SS} | V _{SS} | TDSB2 | TDSA2 | TXN2 |
| G1 | G2 | G3 | G4 | G5 | G6 | G7 | G8 | G9 | G10 | G11 | G12 |
| TXN1 | TDSA1 | TDSB1 | V _{SS} | V _{SS} | V _{SS} | V _{DD} | V _{DD} | V _{DD} | E3M2 | STS2 | TXP2 |
| H1 | H2 | H3 | H4 | H5 | H6 | H7 | H8 | H9 | H10 | H11 | H12 |
| RST | N.C. | N.C. | JTDI | V _{SS} | V _{SS} | V _{DD} | V _{DD} | TCINV | TLBO2 | TTS2 | TCLK2 |
| J1 | J2 | J3 | J4 | J5 | J6 | J7 | J8 | J9 | J10 | J11 | J12 |
| N.C. | N.C. | N.C. | JTDO | TEST | V _{SS} | V _{DD} | HIZ | RCINV | TDM2 | TNEG2 | TPOS2 |
| K1 | K2 | K3 | K4 | K5 | K6 | K7 | K8 | K9 | K10 | K11 | K12 |
| N.C. | N.C. | N.C. | N.C. | N.C. | N.C. | N.C. | RLB2 | TJA2 | RNEG2 | RPOS2 | RCLK2 |
| L1 | L2 | L3 | L4 | L5 | L6 | L7 | L8 | L9 | L10 | L11 | L12 |
| N.C. | N.C. | N.C. | N.C. | N.C. | N.C. | N.C. | LLB2 | RJA2 | N.C. | RTS2 | PRBS2 |
| M1 | M2 | M3 | M4 | M5 | M6 | M7 | M8 | M9 | M10 | M11 | M12 |
| N.C. | N.C. | N.C. | N.C. | N.C. | N.C. | N.C. | STMCLK | RMON2 | RXP2 | RXN2 | RLOS2 |





-  High-Speed Analog
-  High-Speed Digital
-  Low-Speed Digital
-  V_{DD}
-  V_{SS}

Figure 14-6. DS3153 CPU Bus Mode Pin Assignment

| | | | | | | | | | | | |
|-------|-------|-------|-----------------|-----------------|-----------------|-----------------|-----------------|-----------------|-------|-------|--------|
| A1 | A2 | A3 | A4 | A5 | A6 | A7 | A8 | A9 | A10 | A11 | A12 |
| RLOS1 | RXN1 | RXP1 | N.C. | T3MCLK | TXN3 | TXP3 | TCLK3 | TPOS3 | RCLK3 | PRBS3 | RLOS3 |
| B1 | B2 | B3 | B4 | B5 | B6 | B7 | B8 | B9 | B10 | B11 | B12 |
| PRBS1 | RTS1 | N.C. | N.C. | WR | RD | CS | TTS3 | TNEG3 | RPOS3 | RTS3 | RXN3 |
| C1 | C2 | C3 | C4 | C5 | C6 | C7 | C8 | C9 | C10 | C11 | C12 |
| RCLK1 | RPOS1 | RNEG1 | N.C. | INT | MOT | ALE | N.C. | TDM3 | RNEG3 | N.C. | RXP3 |
| D1 | D2 | D3 | D4 | D5 | D6 | D7 | D8 | D9 | D10 | D11 | D12 |
| TPOS1 | TNEG1 | TDM1 | JTRST | JTMS | V _{DD} | V _{SS} | N.C. | N.C. | N.C. | N.C. | N.C. |
| E1 | E2 | E3 | E4 | E5 | E6 | E7 | E8 | E9 | E10 | E11 | E12 |
| TCLK1 | TTS1 | D0 | JTCLK | V _{DD} | V _{DD} | V _{SS} | V _{SS} | HW | N.C. | N.C. | E3MCLK |
| F1 | F2 | F3 | F4 | F5 | F6 | F7 | F8 | F9 | F10 | F11 | F12 |
| TXP1 | D1 | D2 | V _{DD} | V _{DD} | V _{DD} | V _{SS} | V _{SS} | V _{SS} | N.C. | N.C. | TXN2 |
| G1 | G2 | G3 | G4 | G5 | G6 | G7 | G8 | G9 | G10 | G11 | G12 |
| TXN1 | D3 | D4 | V _{SS} | V _{SS} | V _{SS} | V _{DD} | V _{DD} | V _{DD} | N.C. | N.C. | TXP2 |
| H1 | H2 | H3 | H4 | H5 | H6 | H7 | H8 | H9 | H10 | H11 | H12 |
| RST | D5 | D6 | JTDI | V _{SS} | V _{SS} | V _{DD} | V _{DD} | N.C. | N.C. | TTS2 | TCLK2 |
| J1 | J2 | J3 | J4 | J5 | J6 | J7 | J8 | J9 | J10 | J11 | J12 |
| N.C. | N.C. | D7 | JTDO | TEST | V _{SS} | V _{DD} | HIZ | N.C. | TDM2 | TNEG2 | TPOS2 |
| K1 | K2 | K3 | K4 | K5 | K6 | K7 | K8 | K9 | K10 | K11 | K12 |
| N.C. | N.C. | N.C. | N.C. | N.C. | A0 | A2 | A4 | N.C. | RNEG2 | RPOS2 | RCLK2 |
| L1 | L2 | L3 | L4 | L5 | L6 | L7 | L8 | L9 | L10 | L11 | L12 |
| N.C. | N.C. | N.C. | N.C. | N.C. | A1 | A3 | A5 | N.C. | N.C. | RTS2 | PRBS2 |
| M1 | M2 | M3 | M4 | M5 | M6 | M7 | M8 | M9 | M10 | M11 | M12 |
| N.C. | N.C. | N.C. | N.C. | N.C. | N.C. | N.C. | STMCLK | N.C. | RXP2 | RXN2 | RLOS2 |





| | |
|---|--------------------|
|  | High-Speed Analog |
|  | High-Speed Digital |
|  | Low-Speed Digital |
|  | V _{DD} |
|  | V _{SS} |

Figure 14-7. DS3154 Hardware Mode Pin Assignment

| | | | | | | | | | | | |
|-------|-------|-------|-----------------|-----------------|-----------------|-----------------|-----------------|-----------------|-------|-------|--------|
| A1 | A2 | A3 | A4 | A5 | A6 | A7 | A8 | A9 | A10 | A11 | A12 |
| RLOS1 | RXN1 | RXP1 | RMON1 | T3MCLK | TXN3 | TXP3 | TCLK3 | TPOS3 | RCLK3 | PRBS3 | RLOS3 |
| B1 | B2 | B3 | B4 | B5 | B6 | B7 | B8 | B9 | B10 | B11 | B12 |
| PRBS1 | RTS1 | N.C. | RJA1 | LLB1 | TDSA3 | STS3 | TTS3 | TNEG3 | RPOS3 | RTS3 | RXN3 |
| C1 | C2 | C3 | C4 | C5 | C6 | C7 | C8 | C9 | C10 | C11 | C12 |
| RCLK1 | RPOS1 | RNEG1 | TJA1 | RLB1 | TDSB3 | E3M3 | TLBO3 | TDM3 | RNEG3 | N.C. | RXP3 |
| D1 | D2 | D3 | D4 | D5 | D6 | D7 | D8 | D9 | D10 | D11 | D12 |
| TPOS1 | TNEG1 | TDM1 | JTRST | JTMS | V _{DD} | V _{SS} | TBIN | RBIN | TJA3 | RJA3 | RMON3 |
| E1 | E2 | E3 | E4 | E5 | E6 | E7 | E8 | E9 | E10 | E11 | E12 |
| TCLK1 | TTS1 | TLBO1 | JTCLK | V _{DD} | V _{DD} | V _{SS} | V _{SS} | HW | RLB3 | LLB3 | E3MCLK |
| F1 | F2 | F3 | F4 | F5 | F6 | F7 | F8 | F9 | F10 | F11 | F12 |
| TXP1 | STS1 | E3M1 | V _{DD} | V _{DD} | V _{DD} | V _{SS} | V _{SS} | V _{SS} | TDSB2 | TDSA2 | TXN2 |
| G1 | G2 | G3 | G4 | G5 | G6 | G7 | G8 | G9 | G10 | G11 | G12 |
| TXN1 | TDSA1 | TDSB1 | V _{SS} | V _{SS} | V _{SS} | V _{DD} | V _{DD} | V _{DD} | E3M2 | STS2 | TXP2 |
| H1 | H2 | H3 | H4 | H5 | H6 | H7 | H8 | H9 | H10 | H11 | H12 |
| RST | LLB4 | RLB4 | JTDI | V _{SS} | V _{SS} | V _{DD} | V _{DD} | TCINV | TLBO2 | TTS2 | TCLK2 |
| J1 | J2 | J3 | J4 | J5 | J6 | J7 | J8 | J9 | J10 | J11 | J12 |
| RMON4 | RJA4 | TJA4 | JTDO | TEST | V _{SS} | V _{DD} | HIZ | RCINV | TDM2 | TNEG2 | TPOS2 |
| K1 | K2 | K3 | K4 | K5 | K6 | K7 | K8 | K9 | K10 | K11 | K12 |
| RXP4 | N.C. | RNEG4 | TDM4 | TLBO4 | E3M4 | TDSB4 | RLB2 | TJA2 | RNEG2 | RPOS2 | RCLK2 |
| L1 | L2 | L3 | L4 | L5 | L6 | L7 | L8 | L9 | L10 | L11 | L12 |
| RXN4 | RTS4 | RPOS4 | TNEG4 | TTS4 | STS4 | TDSA4 | LLB2 | RJA2 | N.C. | RTS2 | PRBS2 |
| M1 | M2 | M3 | M4 | M5 | M6 | M7 | M8 | M9 | M10 | M11 | M12 |
| RLOS4 | PRBS4 | RCLK4 | TPOS4 | TCLK4 | TXP4 | TXN4 | STMCLK | RMON2 | RXP2 | RXN2 | RLOS2 |











-  High-Speed Analog
-  High-Speed Digital
-  Low-Speed Digital
-  V_{DD}
-  V_{SS}

Figure 14-8. DS3154 CPU Bus Mode Pin Assignment

| | | | | | | | | | | | |
|-------|-------|-------|-----------------|-----------------|-----------------|-----------------|-----------------|-----------------|-------|-------|--------|
| A1 | A2 | A3 | A4 | A5 | A6 | A7 | A8 | A9 | A10 | A11 | A12 |
| RLOS1 | RXN1 | RXP1 | N.C. | T3MCLK | TXN3 | TXP3 | TCLK3 | TPOS3 | RCLK3 | PRBS3 | RLOS3 |
| B1 | B2 | B3 | B4 | B5 | B6 | B7 | B8 | B9 | B10 | B11 | B12 |
| PRBS1 | RTS1 | N.C. | N.C. | WR | RD | CS | TTS3 | TNEG3 | RPOS3 | RTS3 | RXN3 |
| C1 | C2 | C3 | C4 | C5 | C6 | C7 | C8 | C9 | C10 | C11 | C12 |
| RCLK1 | RPOS1 | RNEG1 | N.C. | INT | MOT | ALE | N.C. | TDM3 | RNEG3 | N.C. | RXP3 |
| D1 | D2 | D3 | D4 | D5 | D6 | D7 | D8 | D9 | D10 | D11 | D12 |
| TPOS1 | TNEG1 | TDM1 | JTRST | JTMS | V _{DD} | V _{SS} | N.C. | N.C. | N.C. | N.C. | N.C. |
| E1 | E2 | E3 | E4 | E5 | E6 | E7 | E8 | E9 | E10 | E11 | E12 |
| TCLK1 | TTS1 | D0 | JTCLK | V _{DD} | V _{DD} | V _{SS} | V _{SS} | HW | N.C. | N.C. | E3MCLK |
| F1 | F2 | F3 | F4 | F5 | F6 | F7 | F8 | F9 | F10 | F11 | F12 |
| TXP1 | D1 | D2 | V _{DD} | V _{DD} | V _{DD} | V _{SS} | V _{SS} | V _{SS} | N.C. | N.C. | TXN2 |
| G1 | G2 | G3 | G4 | G5 | G6 | G7 | G8 | G9 | G10 | G11 | G12 |
| TXN1 | D3 | D4 | V _{SS} | V _{SS} | V _{SS} | V _{DD} | V _{DD} | V _{DD} | N.C. | N.C. | TXP2 |
| H1 | H2 | H3 | H4 | H5 | H6 | H7 | H8 | H9 | H10 | H11 | H12 |
| RST | D5 | D6 | JTDI | V _{SS} | V _{SS} | V _{DD} | V _{DD} | N.C. | N.C. | TTS2 | TCLK2 |
| J1 | J2 | J3 | J4 | J5 | J6 | J7 | J8 | J9 | J10 | J11 | J12 |
| N.C. | N.C. | D7 | JTDO | TEST | V _{SS} | V _{DD} | HIZ | N.C. | TDM2 | TNEG2 | TPOS2 |
| K1 | K2 | K3 | K4 | K5 | K6 | K7 | K8 | K9 | K10 | K11 | K12 |
| RXP4 | N.C. | RNEG4 | TDM4 | N.C. | A0 | A2 | A4 | N.C. | RNEG2 | RPOS2 | RCLK2 |
| L1 | L2 | L3 | L4 | L5 | L6 | L7 | L8 | L9 | L10 | L11 | L12 |
| RXN4 | RTS4 | RPOS4 | TNEG4 | TTS4 | A1 | A3 | A5 | N.C. | N.C. | RTS2 | PRBS2 |
| M1 | M2 | M3 | M4 | M5 | M6 | M7 | M8 | M9 | M10 | M11 | M12 |
| RLOS4 | PRBS4 | RCLK4 | TPOS4 | TCLK4 | TXP4 | TXN4 | STMCLK | N.C. | RXP2 | RXN2 | RLOS2 |

-  High-Speed Analog
-  High-Speed Digital
-  Low-Speed Digital
-  V_{DD}
-  V_{SS}

16. THERMAL INFORMATION

Table 16-A. Thermal Properties, Natural Convection

| PARAMETER | MIN | TYP | MAX | UNITS |
|--|-----|------|------|-------|
| Ambient Temperature (Note 1) | -40 | | +85 | °C |
| Junction Temperature | -40 | | +125 | °C |
| Theta-JA (θ_{JA}), Still Air (Note 2) | | 22.4 | | °C/W |
| Psi-JB | | 9.2 | | °C/W |
| Psi-JT | | 1.6 | | °C/W |

Note 1: The package is mounted on a four-layer JEDEC standard test board with no airflow and dissipating maximum power.

Note 2: Theta-JA (θ_{JA}) is the junction-to-ambient thermal resistance, when the package is mounted on a four-layer JEDEC standard test board with no airflow and dissipating maximum power.

Table 16-B. Theta-JA (θ_{JA}) vs. Airflow



| FORCED AIR (m/s) | THETA-JA (θ_{JA}) |
|------------------|----------------------------|
| 0 | 22.4°C/W |
| 1 | 19.0°C/W |
| 2.5 | 17.2°C/W |

17. REVISION HISTORY

| REVISION | DESCRIPTION |
|----------|--|
| 012103 | DS3154 new product release |
| 040403 | <p>DS3151/DS3152/DS3153 new product releases.</p> <p><i>Electrical Characteristics</i> section, Notes 1 and 2: Changed 44.73MHz to 51.84MHz; added indication that specs are lower for rev A2; "all ones driven into RXPn/RXNn (1.0V square wave)" changed to "analog loopback enabled" to match production test methodology.</p> <p>Table 13-B, Input leakage, I_{IL}: -10μA min changed to -50μA min.</p> <p>Table 13-B: Replaced TBD values for I_{DD}, I_{DDTS}, and I_{DDPD} (DS3151/DS3152/DS3153); changed I_{DDPD} spec from 38 typ and 50 max to 45 typ and 70 max.</p> <p>Table 14-A and Table 14-B: Changed pins RBIN, RCINV, TBIN, and TCINV to "N.C." to reflect they are not available in CPU bus mode.</p> |
| 072303 | <p>Figure 1-1: Labeled capacitors connected to transformer center taps as "(optional)".</p> <p>Section 6, Optional Pre-Amp Paragraph: Clarified that the pre-amp contributes +14dB of flat gain.</p> <p>Table 11-A: Changed leakage inductance to 0.150μH max.</p> <p>Table 11-B: Reformatted table and added row for Pulse Engineering's T3049 octal transformer.</p> <p>Table 13-H: Reworded Note 20.</p> |
| 120303 | <p>GCR Register Definition (page 16): Clarified that the RST bit holds the digital logic of the LIU in reset rather than the whole LIU.</p> <p>Table 13-B: Changed DS3151 I_{DD} from 130mA (max) to 100mA (max). Changed DS3151 I_{DDTTS} from 105mA (max) to 80mA (max). Removed sentences in Notes 1 and 2 that labeled the I_{DD} and I_{DDTTS} specs for rev A1 devices.</p> |
| 052404 | Added typical I_{DD} and I_{DDTTS} numbers to Table 13-B. |
| 110404 | <p>Table 13-D and Table 13-E: Changed ALOS set and clear thresholds to typical numbers.</p> <p>Figure 13-4: Added second note to the Read Cycle timing diagrams.</p> |
| 062705 | Page 18: RCINV bit description: Changed 0 = rising edge to falling edge; changed 1 = falling edge to rising edge. |
| 030607 | <p>Page 39: In Table 13-D and Table 13-E, changed the TYP receiver input characteristics to show increased sensitivity:</p> <ul style="list-style-type: none"> Analog LOS Declare, RMON = 0 from -23 to -24 Analog LOS Clear, RMON = 0 from -20 to -21 Analog LOS Declare, RMON = 1 from -37 to -38 Analog LOS Clear, RMON = 1 from -34 to -35 |

Looking for pricing, stock, or lifecycle information?

Click below to explore more details on WIN SOURCE:

-  [View DS3154N+ on WIN SOURCE](#)
-  [Maxim Integrated Information](#)

Optimize Your Supply Chain with WIN SOURCE Solutions

-  Global Sourcing Solution
-  Obsolete Management
-  Cost Control Management
-  Shortage Management
-  Alternative Solution
-  Excess Inventory Management