



**THE DATASHEET OF  
LTC3410ESC6-1.875#TRPBF**



## 2.25MHz, 300mA Synchronous Step-Down Regulator in SC70

### FEATURES

- **High Efficiency: Up to 93%**
- **Very Low Quiescent Current: Only 26 $\mu$ A**
- **Low Output Voltage Ripple**
- **300mA Output Current at  $V_{IN} = 3V$**
- **380mA Minimum Peak Switch Current**
- **2.5V to 5.5V Input Voltage Range**
- **2.25MHz Constant Frequency Operation**
- **No Schottky Diode Required**
- **Stable with Ceramic Capacitors**
- **Shutdown Mode Draws <1 $\mu$ A Supply Current**
- **$\pm 2\%$  Output Voltage Accuracy**
- **Current Mode Operation for Excellent Line and Load Transient Response**
- **Overtemperature Protected**
- **Available in Low Profile SC70 Package**

### APPLICATIONS

- Cellular Telephones
- Wireless and DSL Modems
- Digital Cameras
- MP3 Players
- Portable Instruments

### DESCRIPTION

The LTC<sup>®</sup>3410-1.875 is a high efficiency monolithic synchronous buck regulator using a constant frequency, current mode architecture. Supply current during operation is only 26 $\mu$ A, dropping to <1 $\mu$ A in shutdown. The 2.5V to 5.5V input voltage range makes the LTC3410-1.875 ideally suited for single Li-Ion battery-powered applications. 100% duty cycle provides low dropout operation, extending battery life in portable systems.

Switching frequency is internally set at 2.25MHz, allowing the use of small surface mount inductors and capacitors. The LTC3410-1.875 is specifically designed to work well with ceramic output capacitors, achieving very low output voltage ripple and a small PCB footprint.

The internal synchronous switch increases efficiency and eliminates the need for an external Schottky diode. The LTC3410-1.875 is available in a tiny, low profile SC70 package.

LT, LT, LTC and LTM are registered trademarks of Linear Technology Corporation. All other trademarks are the property of their respective owners. Protected by U.S. Patents, including 5481178, 5994885, 6127815, 6304066, 6498466, 6580258, 6611131.

### TYPICAL APPLICATION

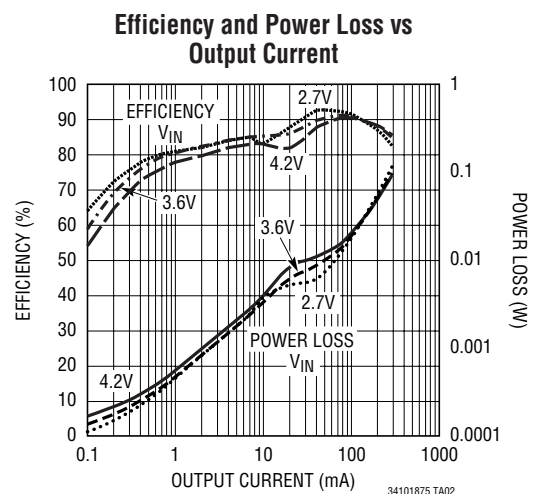
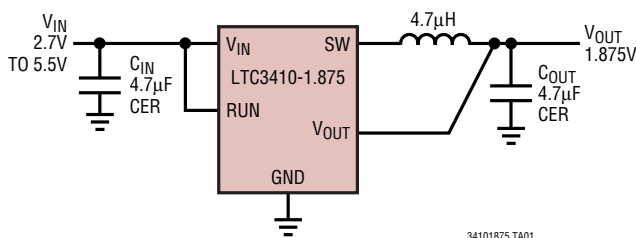

34101875f

## ABSOLUTE MAXIMUM RATINGS

(Note 1)

Input Supply Voltage .....	-0.3V to 6V
RUN, V <sub>OUT</sub> Voltages.....	-0.3V to V <sub>IN</sub>
SW Voltage (DC) .....	-0.3V to (V <sub>IN</sub> + 0.3V)
P-Channel Switch Source Current (DC) .....	500mA
N-Channel Switch Sink Current (DC) .....	500mA
Peak SW Sink and Source Current .....	630mA
Operating Temperature Range (Note 2) ..	-40°C to 85°C
Junction Temperature (Notes 3, 5) .....	125°C
Storage Temperature Range .....	-65°C to 150°C
Lead Temperature (Soldering, 10 sec).....	300°C

## PACKAGE/ORDER INFORMATION

	ORDER PART NUMBER
	LTC3410ESC6-1.875
	SC6 PART MARKING
	LCFQ
<b>Order Options</b> Tape and Reel: Add #TR Lead Free: Add #PBF Lead Free Tape and Reel: Add #TRPBF Lead Free Part Marking: <a href="http://www.linear.com/leadfree/">http://www.linear.com/leadfree/</a>	

Consult LTC Marketing for parts specified with wider operating temperature ranges.

## ELECTRICAL CHARACTERISTICS

The ● denotes specifications which apply over the full operating temperature range, otherwise specifications are T<sub>A</sub> = 25°C. V<sub>IN</sub> = 3.6V unless otherwise specified.

SYMBOL	PARAMETER	CONDITIONS	MIN	TYP	MAX	UNITS	
I <sub>VOUT</sub>	Output Voltage Feedback Current		●	3.3	6	μA	
I <sub>PK</sub>	Peak Inductor Current	V <sub>IN</sub> = 3V, V <sub>OUT</sub> = 1.64V, Duty Cycle < 35%		380	500	mA	
V <sub>OUT</sub>	Regulated Output Voltage		●	1.837	1.875	1.913	V
ΔV <sub>OUT</sub>	Output Voltage Line Regulation	V <sub>IN</sub> = 2.5V to 5.5V	●	0.04	0.4	%/V	
V <sub>LOADREG</sub>	Output Voltage Load Regulation	I <sub>LOAD</sub> = 50mA to 250mA		0.5		%	
V <sub>IN</sub>	Input Voltage Range		●	2.5	5.5	V	
V <sub>UVLO</sub>	Undervoltage Lockout Threshold	V <sub>IN</sub> Rising V <sub>IN</sub> Falling		2 1.94	2.3	V V	
I <sub>S</sub>	Input DC Bias Current Burst Mode® Operation Shutdown	(Note 4) V <sub>OUT</sub> = 1.945V, I <sub>LOAD</sub> = 0A V <sub>RUN</sub> = 0V		26 0.1	35 1	μA μA	
f <sub>OSC</sub>	Oscillator Frequency	V <sub>OUT</sub> = 1.875V V <sub>OUT</sub> = 0V	●	1.8 310	2.7	MHz kHz	
R <sub>PFET</sub>	R <sub>DS(ON)</sub> of P-Channel FET	I <sub>SW</sub> = 100mA		0.75	0.9	Ω	
R <sub>NFET</sub>	R <sub>DS(ON)</sub> of N-Channel FET	I <sub>SW</sub> = -100mA		0.55	0.7	Ω	
I <sub>LSW</sub>	SW Leakage	V <sub>RUN</sub> = 0V, V <sub>SW</sub> = 0V or 5V, V <sub>IN</sub> = 5V		±0.01	±1	μA	
V <sub>RUN</sub>	RUN Threshold		●	0.3	1	1.5	V
I <sub>RUN</sub>	RUN Leakage Current		●	±0.01	±1	μA	

Burst Mode is a registered trademark of Linear Technology Corporation.

**Note 1:** Stresses beyond those listed under Absolute Maximum Ratings may cause permanent damage to the device. Exposure to any Absolute Maximum Rating condition for extended periods may affect device reliability and lifetime.

**Note 2:** The LTC3410E-1.875 is guaranteed to meet performance specifications from 0°C to 70°C. Specifications over the -40°C to 85°C operating temperature range are assured by design, characterization and correlation with statistical process controls.

**Note 3:** T<sub>J</sub> is calculated from the ambient temperature T<sub>A</sub> and power

dissipation P<sub>D</sub> according to the following formula:

$$T_{J} = T_{A} + (P_{D})(250^{\circ}\text{C}/\text{W})$$

**Note 4:** Dynamic supply current is higher due to the gate charge being delivered at the switching frequency.

**Note 5:** This IC includes overtemperature protection that is intended to protect the device during momentary overload conditions. Junction temperature will exceed 125°C when overtemperature protection is active. Continuous operation above the specified maximum operating junction temperature may impair device reliability.

# TYPICAL PERFORMANCE CHARACTERISTICS

(From Figure 1)

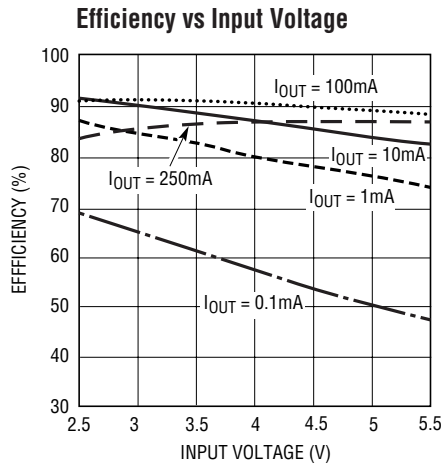

34101875 G01

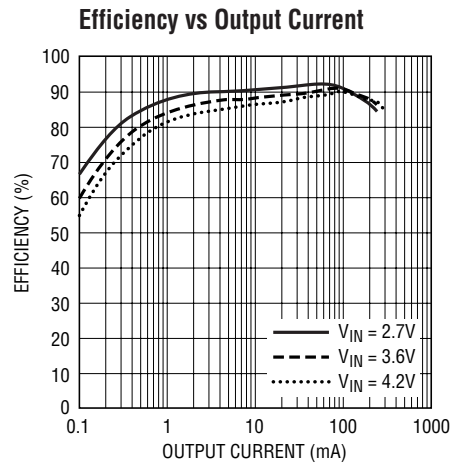

34101875 G02

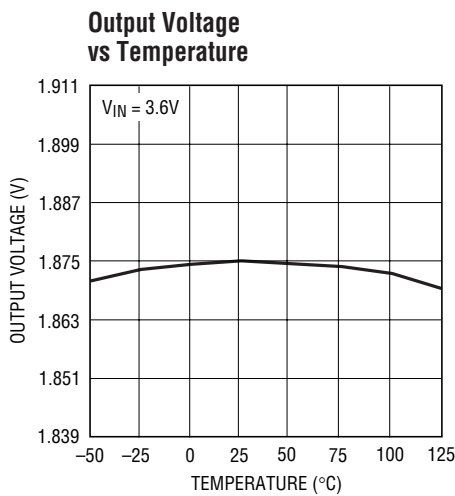

34101875 G03

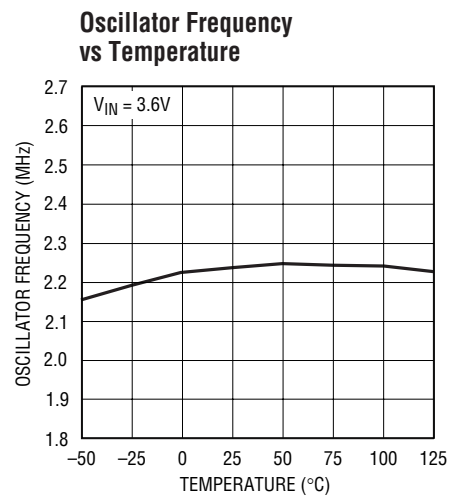

34101875 G04

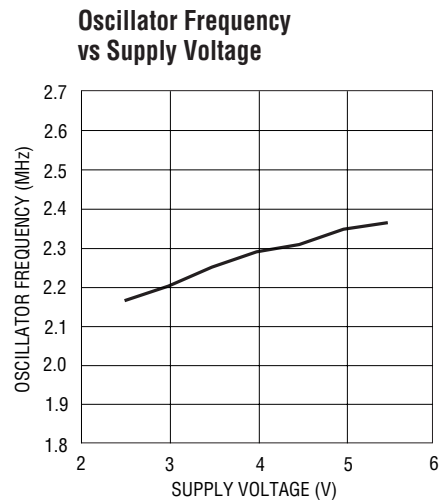

34101875 G05

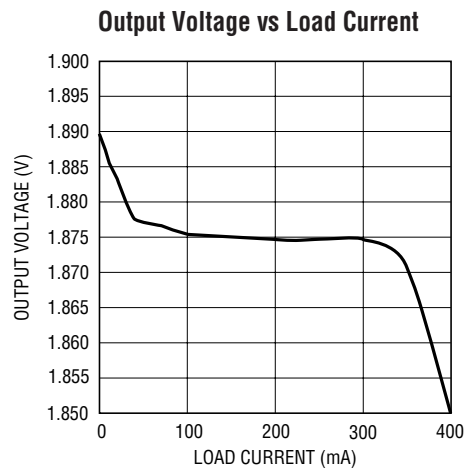

34101875 G06

# TYPICAL PERFORMANCE CHARACTERISTICS

(From Figure 1)

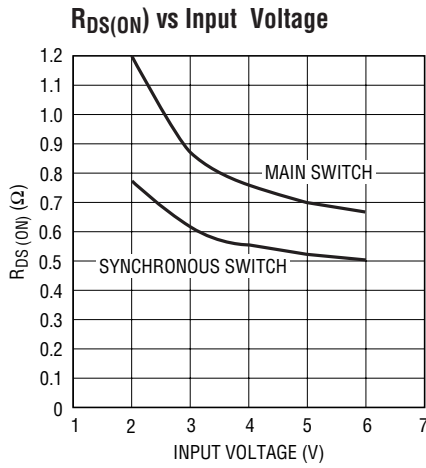

34101875 G07

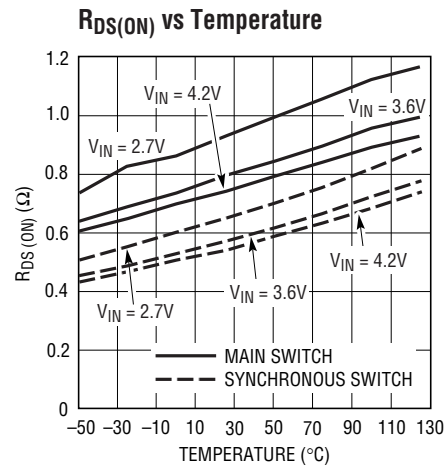

34101875 G08

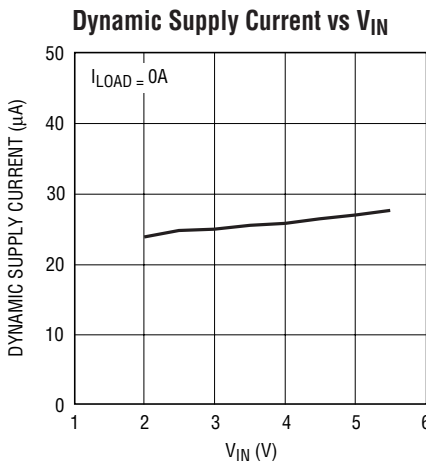

34101875 G09

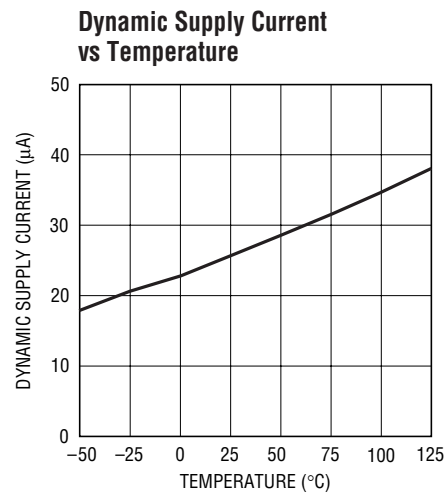

34101875 G10

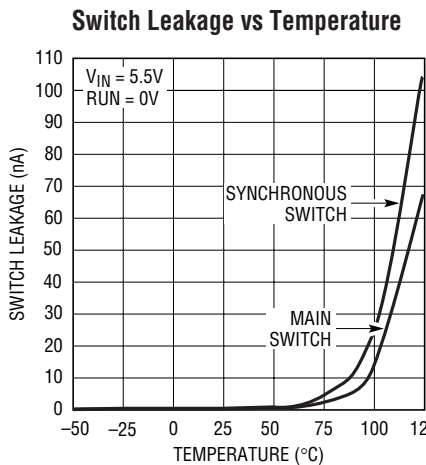

34101875 G11

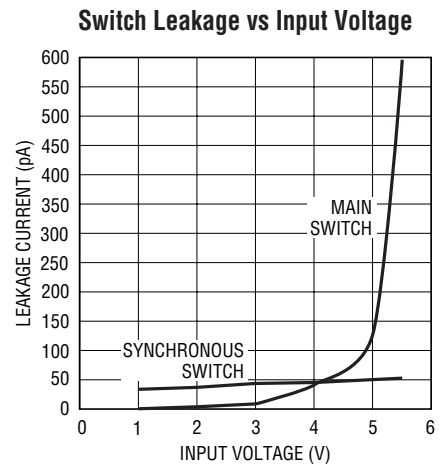

34101875 G12

# TYPICAL PERFORMANCE CHARACTERISTICS

(From Figure 1)

**Burst Mode Operation**

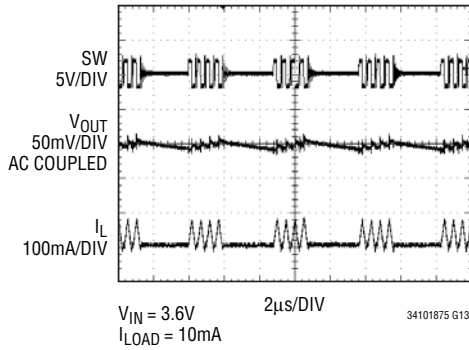

**Start-Up from Shutdown**

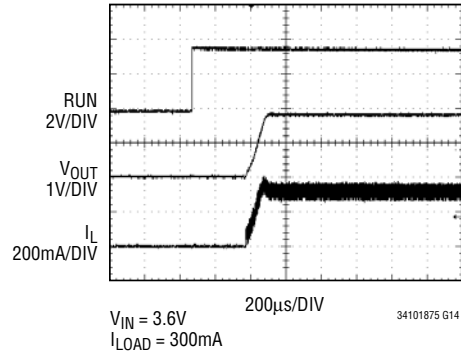

**Start-Up from Shutdown**

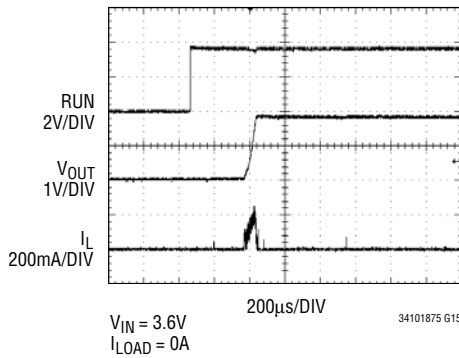

**Load Step**

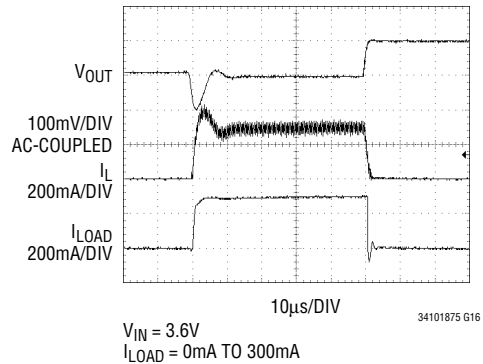

**Load Step**

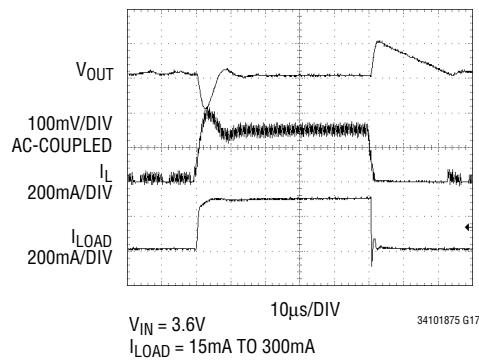

## PIN FUNCTIONS

**RUN (Pin 1):** Run Control Input. Forcing this pin above 1.5V enables the part. Forcing this pin below 0.3V shuts down the device. In shutdown, all functions are disabled drawing  $<1\mu\text{A}$  supply current. Do not leave RUN floating.

**GND (Pins 2, 5):** Ground Pin.

**SW (Pin 3):** Switch Node Connection to Inductor. This pin connects to the drains of the internal main and synchronous power MOSFET switches.

**V<sub>IN</sub> (Pin 4):** Main Supply Pin. Must be closely decoupled to GND, Pin 2, with a 2.2 $\mu\text{F}$  or greater ceramic capacitor.

**V<sub>OUT</sub> (Pin 6):** Output Voltage Feedback. An internal resistive divider divides the output voltage down for comparison to the internal 0.8V reference voltage.

## FUNCTIONAL DIAGRAM

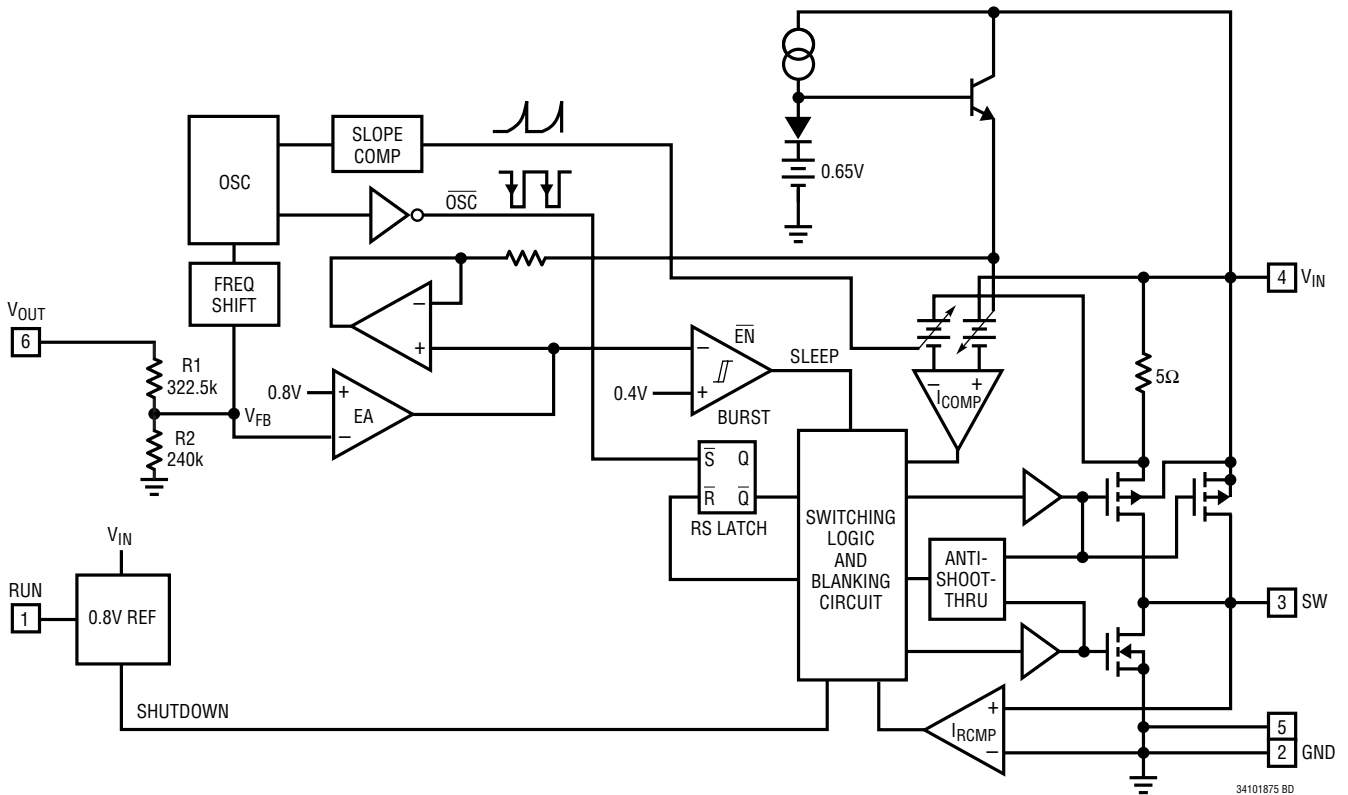

34101875 BD

## OPERATION (Refer to Functional Diagram)

### Main Control Loop

The LTC3410-1.875 uses a constant frequency, current mode step-down architecture. Both the main (P-channel MOSFET) and synchronous (N-channel MOSFET) switches are internal. During normal operation, the internal top power MOSFET is turned on each cycle when the oscillator sets the RS latch, and turned off when the current comparator,  $I_{COMP}$ , resets the RS latch. The peak inductor current at which  $I_{COMP}$  resets the RS latch, is controlled by the output of error amplifier EA. The  $V_{OUT}$  pin, described in the Pin Functions section, allows EA to receive an output feedback voltage from the internal resistive divider. When the load current increases, it causes a slight decrease in the feedback voltage relative to the 0.8V reference, which in turn, causes the EA amplifier's output voltage to increase until the average inductor current matches the new load current. While the top MOSFET is off, the bottom MOSFET is turned on until either the inductor current starts to reverse, as indicated by the current reversal comparator  $I_{RCMP}$ , or the beginning of the next clock cycle.

### Burst Mode Operation

The LTC3410-1.875 is capable of Burst Mode operation in which the internal power MOSFETs operate intermittently based on load demand.

When the converter is in Burst Mode operation, the peak current of the inductor is set to approximately 70mA regardless of the output load. Each burst event can last from a few cycles at light loads to almost continuously cycling with short sleep intervals at moderate loads. In between these burst events, the power MOSFETs and any unneeded circuitry are turned off, reducing the quiescent current to 26 $\mu$ A. In this sleep state, the load current is being supplied solely from the output capacitor. As the output voltage droops, the EA amplifier's output rises above the sleep threshold signaling the BURST comparator to trip and turn the top MOSFET on. This process repeats at a rate that is dependent on the load demand.

### Short-Circuit Protection

When the output is shorted to ground, the frequency of the oscillator is reduced to about 310kHz, 1/7 the nominal frequency. This frequency foldback ensures that the inductor current has more time to decay, thereby preventing runaway. The oscillator's frequency will progressively increase to 2.25MHz when  $V_{OUT}$  rises above 0V.

### Slope Compensation and Inductor Peak Current

Slope compensation provides stability in constant frequency architectures by preventing subharmonic oscillations at high duty cycles. It is accomplished internally by adding a compensating ramp to the inductor current signal at duty cycles in excess of 40%. Normally, this results in a reduction of maximum inductor peak current for duty cycles > 40%. However, the LTC3410-1.875 uses a patented scheme that counteracts this compensating ramp, which allows the maximum inductor peak current to remain unaffected throughout all duty cycles.

## APPLICATIONS INFORMATION

The basic LTC3410-1.875 application circuit is shown in Figure 1. External component selection is driven by the load requirement and begins with the selection of L followed by  $C_{IN}$  and  $C_{OUT}$ .

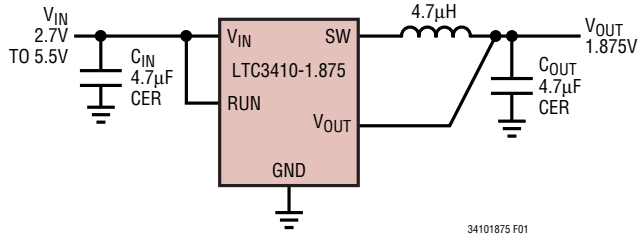

Figure 1. High Efficiency Step-Down Converter

### Inductor Selection

For most applications, the value of the inductor will fall in the range of 2.2µH to 4.7µH. Its value is chosen based on the desired ripple current. Large value inductors lower ripple current and small value inductors result in higher ripple currents. Higher  $V_{IN}$  or  $V_{OUT}$  also increases the ripple current as shown in equation 1. A reasonable starting point for setting ripple current is  $\Delta I_L = 120\text{mA}$  (40% of 300mA).

$$\Delta I_L = \frac{1}{(f)(L)} V_{OUT} \left( 1 - \frac{V_{OUT}}{V_{IN}} \right) \quad (1)$$

The DC current rating of the inductor should be at least equal to the maximum load current plus half the ripple current to prevent core saturation. Thus, a 360mA rated inductor should be enough for most applications (300mA + 60mA). For better efficiency, choose a low DC-resistance inductor.

The inductor value also has an effect on Burst Mode operation. The transition to low current operation begins when the inductor current peaks fall to approximately 100mA. Lower inductor values (higher  $\Delta I_L$ ) will cause this to occur at lower load currents, which can cause a dip in efficiency in the upper range of low current operation. In Burst Mode operation, lower inductance values will cause the burst frequency to increase.

### Inductor Core Selection

Different core materials and shapes will change the size/current and price/current relationship of an inductor. Toroid or shielded pot cores in ferrite or permalloy materials are small and do not radiate much energy, but generally cost more than powdered iron core inductors with similar electrical characteristics. The choice of which style inductor to use often depends more on the price vs size requirements and any radiated field/EMI requirements than on what the LTC3410-1.875 requires to operate. Table 1 shows some typical surface mount inductors that work well in LTC3410-1.875 applications.

Table 1. Representative Surface Mount Inductors

MANUFACTURER	PART NUMBER	VALUE	MAX DC CURRENT	DCR	HEIGHT
Taiyo Yuden	CB2016T2R2M	2.2µH	510mA	0.13Ω	1.6mm
	CB2012T2R2M	2.2µH	530mA	0.33Ω	1.25mm
	LBC2016T3R3M	3.3µH	410mA	0.27Ω	1.6mm
Panasonic	ELT5KT4R7M	4.7µH	950mA	0.2Ω	1.2mm
Sumida	CDRH2D18/LD	4.7µH	630mA	0.086Ω	2mm
Murata	LQH32CN4R7M23	4.7µH	450mA	0.2Ω	2mm
Taiyo Yuden	NR30102R2M	2.2µH	1100mA	0.1Ω	1mm
	NR30104R7M	4.7µH	750mA	0.19Ω	1mm
FDK	FDKMIPF2520D	4.7µH	1100mA	0.11Ω	1mm
	FDKMIPF2520D	3.3µH	1200mA	0.1Ω	1mm
	FDKMIPF2520D	2.2µH	1300mA	0.08Ω	1mm

## APPLICATIONS INFORMATION

### $C_{IN}$ and $C_{OUT}$ Selection

In continuous mode, the source current of the top MOSFET is a square wave of duty cycle  $V_{OUT}/V_{IN}$ . To prevent large voltage transients, a low ESR input capacitor sized for the maximum RMS current must be used. The maximum RMS capacitor current is given by:

$$C_{IN} \text{ required } I_{RMS} \cong I_{OMAX} \frac{[V_{OUT}(V_{IN}-V_{OUT})]^{1/2}}{V_{IN}}$$

This formula has a maximum at  $V_{IN} = 2V_{OUT}$ , where  $I_{RMS} = I_{OUT}/2$ . This simple worst-case condition is commonly used for design because even significant deviations do not offer much relief. Note that the capacitor manufacturer's ripple current ratings are often based on 2000 hours of life. This makes it advisable to further derate the capacitor, or choose a capacitor rated at a higher temperature than required. Always consult the manufacturer if there is any question.

The selection of  $C_{OUT}$  is driven by the required effective series resistance (ESR). Typically, once the ESR requirement for  $C_{OUT}$  has been met, the RMS current rating generally far exceeds the  $I_{RIPPLE(P-P)}$  requirement. The output ripple  $\Delta V_{OUT}$  is determined by:

$$\Delta V_{OUT} \cong \Delta I_L \left( ESR + \frac{1}{8fC_{OUT}} \right)$$

where  $f$  = operating frequency,  $C_{OUT}$  = output capacitance and  $\Delta I_L$  = ripple current in the inductor. For a fixed output voltage, the output ripple is highest at maximum input voltage since  $\Delta I_L$  increases with input voltage.

If tantalum capacitors are used, it is critical that the capacitors are surge tested for use in switching power supplies. An excellent choice is the AVX TPS series of surface mount tantalum. These are specially constructed and tested for low ESR so they give the lowest ESR for a given volume. Other capacitor types include Sanyo POSCAP, Kemet T510 and T495 series, and Sprague 593D and 595D series. Consult the manufacturer for other specific recommendations.

### Using Ceramic Input and Output Capacitors

Higher values, lower cost ceramic capacitors are now becoming available in smaller case sizes. Their high ripple current, high voltage rating and low ESR make them ideal for switching regulator applications. Because the LTC3410-1.875's control loop does not depend on the output capacitor's ESR for stable operation, ceramic capacitors can be used freely to achieve very low output ripple and small circuit size.

However, care must be taken when ceramic capacitors are used at the input and the output. When a ceramic capacitor is used at the input and the power is supplied by a wall adapter through long wires, a load step at the output can induce ringing at the input,  $V_{IN}$ . At best, this ringing can couple to the output and be mistaken as loop instability. At worst, a sudden inrush of current through the long wires can potentially cause a voltage spike at  $V_{IN}$ , large enough to damage the part.

When choosing the input and output ceramic capacitors, choose the X5R or X7R dielectric formulations. These dielectrics have the best temperature and voltage characteristics of all the ceramics for a given value and size.

The recommended capacitance value to use is 4.7 $\mu$ F for both the input and output capacitors.

## APPLICATIONS INFORMATION

### Efficiency Considerations

The efficiency of a switching regulator is equal to the output power divided by the input power times 100%. It is often useful to analyze individual losses to determine what is limiting the efficiency and which change would produce the most improvement. Efficiency can be expressed as:

$$\text{Efficiency} = 100\% - (L1 + L2 + L3 + \dots)$$

where L1, L2, etc. are the individual losses as a percentage of input power.

Although all dissipative elements in the circuit produce losses, two main sources usually account for most of the losses in LTC3410-1.875 circuits:  $V_{IN}$  quiescent current and  $I^2R$  losses. The  $V_{IN}$  quiescent current loss dominates the efficiency loss at very low load currents whereas the  $I^2R$  loss dominates the efficiency loss at medium to high load currents. In a typical efficiency plot, the efficiency curve at very low load currents can be misleading since the actual power lost is of no consequence as illustrated in Figure 2.

1. The  $V_{IN}$  quiescent current is due to two components: the DC bias current as given in the electrical characteristics and the internal main switch and synchronous switch gate charge currents. The gate charge current results from switching the gate capacitance of the internal power MOSFET switches. Each time the gate is

switched from high to low to high again, a packet of charge,  $dQ$ , moves from  $V_{IN}$  to ground. The resulting  $dQ/dt$  is the current out of  $V_{IN}$  that is typically larger than the DC bias current. In continuous mode,  $I_{GATECHG} = f(Q_T + Q_B)$  where  $Q_T$  and  $Q_B$  are the gate charges of the internal top and bottom switches. Both the DC bias and gate charge losses are proportional to  $V_{IN}$  and thus their effects will be more pronounced at higher supply voltages.

2.  $I^2R$  losses are calculated from the resistances of the internal switches,  $R_{SW}$ , and external inductor  $R_L$ . In continuous mode, the average output current flowing through inductor L is “chopped” between the main switch and the synchronous switch. Thus, the series resistance looking into the SW pin is a function of both top and bottom MOSFET  $R_{DS(ON)}$  and the duty cycle (DC) as follows:

$$R_{SW} = (R_{DS(ON)TOP})(DC) + (R_{DS(ON)BOT})(1 - DC)$$

The  $R_{DS(ON)}$  for both the top and bottom MOSFETs can be obtained from the Typical Performance Characteristics curves. Thus, to obtain  $I^2R$  losses, simply add  $R_{SW}$  to  $R_L$  and multiply the result by the square of the average output current.

Other losses including  $C_{IN}$  and  $C_{OUT}$  ESR dissipative losses and inductor core losses generally account for less than 2% total additional loss.

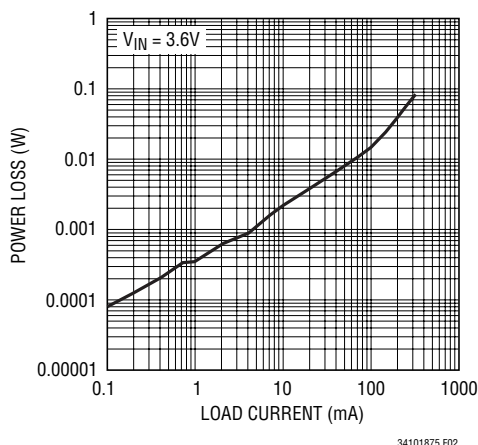

Figure 2. Power Loss vs Load Current

## APPLICATIONS INFORMATION

### Thermal Considerations

In most applications the LTC3410-1.875 does not dissipate much heat due to its high efficiency. But, in applications where the LTC3410-1.875 is running at high ambient temperature with low supply voltage, the heat dissipated may exceed the maximum junction temperature of the part. If the junction temperature reaches approximately 150°C, both power switches will be turned off and the SW node will become high impedance.

To prevent the LTC3410-1.875 from exceeding the maximum junction temperature, the user will need to do some thermal analysis. The goal of the thermal analysis is to determine whether the power dissipated exceeds the maximum junction temperature of the part. The temperature rise is given by:

$$T_R = (P_D)(\theta_{JA})$$

where  $P_D$  is the power dissipated by the regulator and  $\theta_{JA}$  is the thermal resistance from the junction of the die to the ambient temperature.

The junction temperature,  $T_J$ , is given by:

$$T_J = T_A + T_R$$

where  $T_A$  is the ambient temperature.

As an example, consider the LTC3410-1.875 with an input voltage of 2.7V, a load current of 300mA and an ambient temperature of 70°C. From the typical performance graph of switch resistance, the  $R_{DS(ON)}$  of the P-channel switch at 70°C is approximately 1.05Ω and the  $R_{DS(ON)}$  of the N-channel synchronous switch is approximately 0.75Ω. The series resistance looking into the SW pin is:

$$R_{SW} = 1.05\Omega (0.69) + 0.75\Omega (0.31) = 0.96\Omega$$

Therefore, power dissipated by the part is:

$$P_D = I_{LOAD}^2 \cdot R_{DS(ON)} = 86.4\text{mW}$$

For the SC70 package, the  $\theta_{JA}$  is 250°C/W. Thus, the junction temperature of the regulator is:

$$T_J = 70^\circ\text{C} + (0.0864)(250) = 91.6^\circ\text{C}$$

which is well below the maximum junction temperature of 125°C.

Note that at higher supply voltages, the junction temperature is lower due to reduced switch resistance ( $R_{DS(ON)}$ ).

### Checking Transient Response

The regulator loop response can be checked by looking at the load transient response. Switching regulators take several cycles to respond to a step in load current. When a load step occurs,  $V_{OUT}$  immediately shifts by an amount equal to  $(\Delta I_{LOAD} \cdot ESR)$ , where ESR is the effective series resistance of  $C_{OUT}$ .  $\Delta I_{LOAD}$  also begins to charge or discharge  $C_{OUT}$ , which generates a feedback error signal. The regulator loop then acts to return  $V_{OUT}$  to its steady-state value. During this recovery time  $V_{OUT}$  can be monitored for overshoot or ringing that would indicate a stability problem. For a detailed explanation of switching control loop theory, see Application Note 76.

A second, more severe transient is caused by switching in loads with large ( $>1\mu\text{F}$ ) supply bypass capacitors. The discharged bypass capacitors are effectively put in parallel with  $C_{OUT}$ , causing a rapid drop in  $V_{OUT}$ . No regulator can deliver enough current to prevent this problem if the load switch resistance is low and it is driven quickly. The only solution is to limit the rise time of the switch drive so that the load rise time is limited to approximately  $(25 \cdot C_{LOAD})$ . Thus, a 10μF capacitor charging to 3.3V would require a 250μs rise time, limiting the charging current to about 130mA.

## APPLICATIONS INFORMATION

### PC Board Layout Checklist

When laying out the printed circuit board, the following checklist should be used to ensure proper operation of the LTC3410-1.875. These items are also illustrated graphically in Figures 3 and 4. Check the following in your layout:

1. The power traces, consisting of the GND trace, the SW trace and the  $V_{IN}$  trace should be kept short, direct and wide.
2. Does the (+) plate of  $C_{IN}$  connect to  $V_{IN}$  as closely as possible? This capacitor provides the AC current to the internal power MOSFETs.
3. Keep the (-) plates of  $C_{IN}$  and  $C_{OUT}$  as close as possible.

### Design Example

As a design example, assume the LTC3410-1.875 is used in a single lithium-ion battery-powered cellular phone application. The  $V_{IN}$  will be operating from a maximum of 4.2V down to about 2.7V. The load current requirement is a maximum of 0.3A but most of the time it will be in standby mode, requiring only 2mA. Efficiency at both low

and high load currents is important. With this information we can calculate L using Equation (1),

$$L = \frac{1}{f(\Delta I_L)} V_{OUT} \left( 1 - \frac{V_{OUT}}{V_{IN}} \right) \quad (3)$$

Substituting  $V_{OUT} = 1.875V$ ,  $V_{IN} = 4.2V$ ,  $\Delta I_L = 100mA$  and  $f = 2.25MHz$  in Equation (3) gives:

$$L = \frac{1.875V}{2.25MHz(100mA)} \left( 1 - \frac{1.875V}{4.2V} \right) = 4.6\mu H$$

A 4.7 $\mu H$  inductor works well for this application. For best efficiency choose a 360mA or greater inductor with less than 0.3 $\Omega$  series resistance.

$C_{IN}$  will require an RMS current rating of at least  $0.125A \cong I_{LOAD(MAX)}/2$  at temperature and  $C_{OUT}$  will require an ESR of less than 0.5 $\Omega$ . In most cases, a ceramic capacitor will satisfy this requirement.

Figure 5 shows the complete circuit along with its efficiency curve.

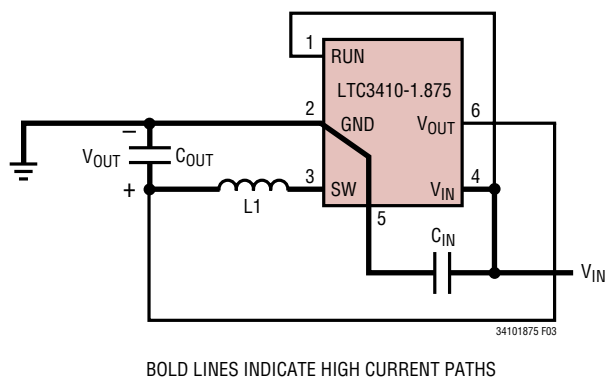

Figure 3. LTC3410-1.875 Layout Diagram

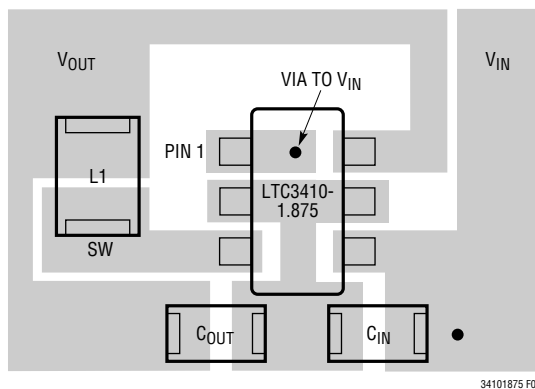

Figure 4. LTC3410-1.875 Suggested Layout

# APPLICATIONS INFORMATION

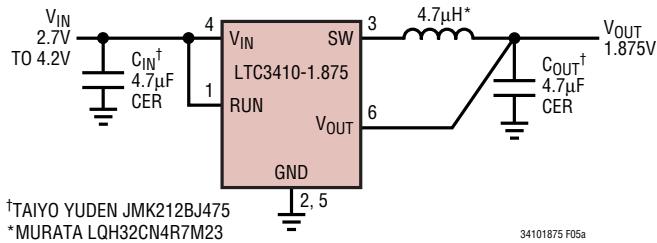

Figure 5a

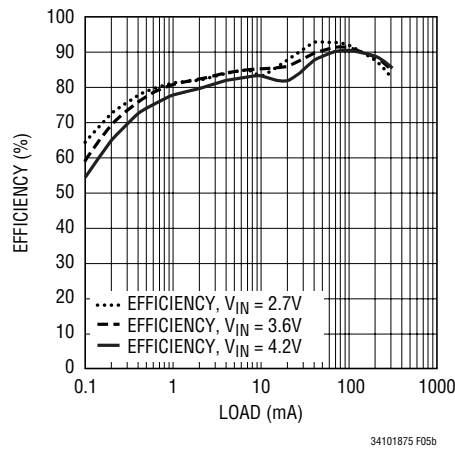

Figure 5b

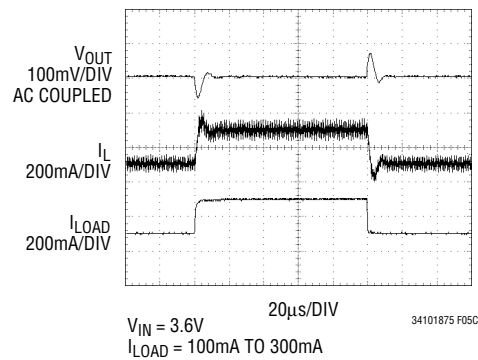
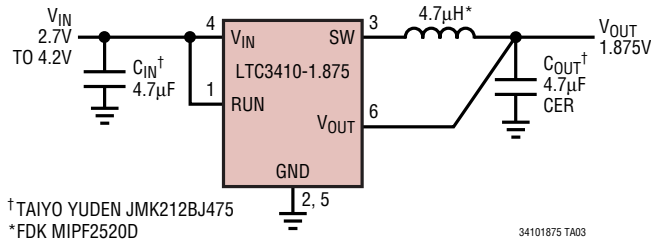

Figure 5c

# TYPICAL APPLICATION

## Using Low Profile Components, <1mm Height



## Low Profile Efficiency

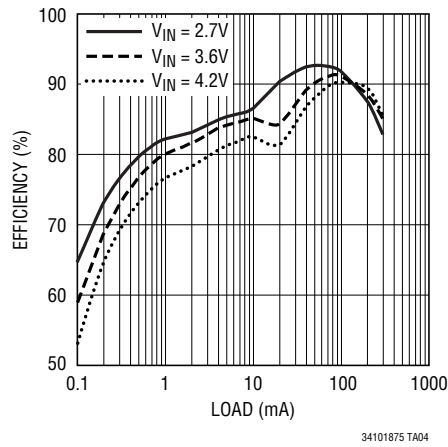

## Load Step

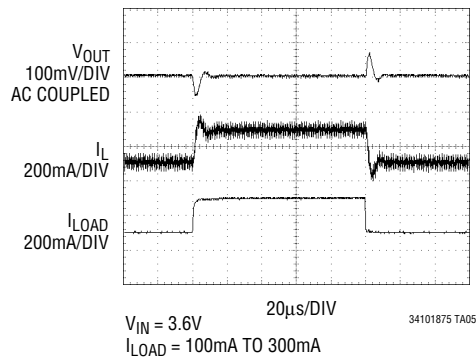

# PACKAGE DESCRIPTION

## SC6 Package 6-Lead Plastic SC70 (Reference LTC DWG # 05-08-1638)

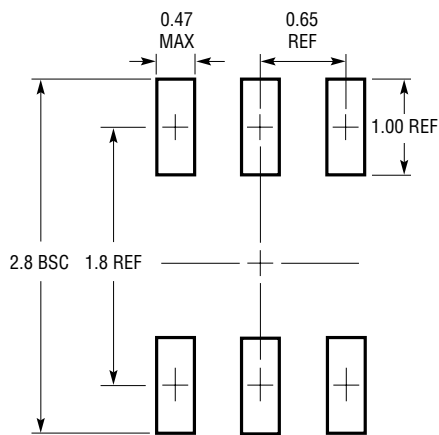

RECOMMENDED SOLDER PAD LAYOUT  
PER IPC CALCULATOR

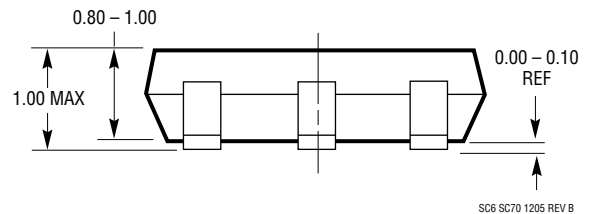
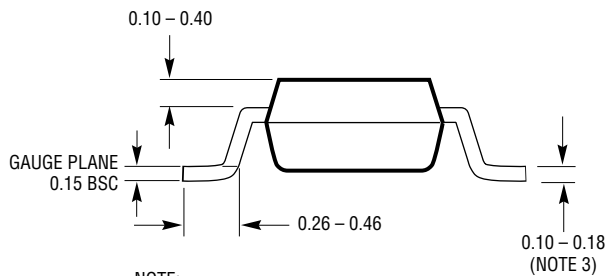
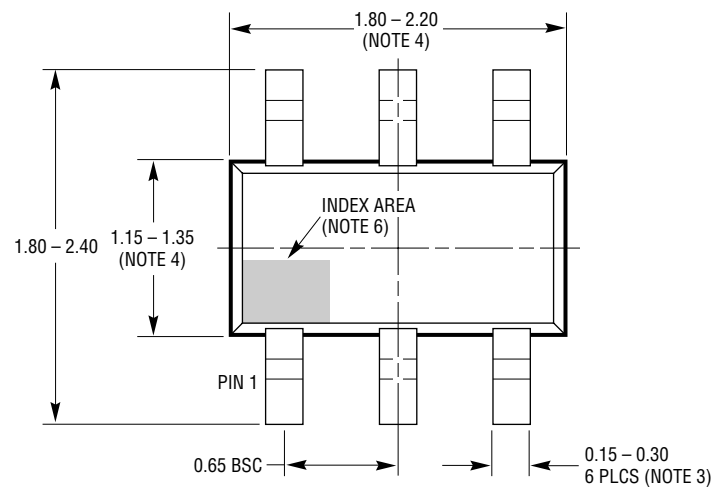

SC6 SC70 1205 REV B

### NOTE:

1. DIMENSIONS ARE IN MILLIMETERS
2. DRAWING NOT TO SCALE
3. DIMENSIONS ARE INCLUSIVE OF PLATING
4. DIMENSIONS ARE EXCLUSIVE OF MOLD FLASH AND METAL BURR
5. MOLD FLASH SHALL NOT EXCEED 0.254mm
6. DETAILS OF THE PIN 1 IDENTIFIER ARE OPTIONAL,  
BUT MUST BE LOCATED WITHIN THE INDEX AREA
7. EIAJ PACKAGE REFERENCE IS EIAJ SC-70
8. JEDEC PACKAGE REFERENCE IS MO-203 VARIATION AB

**RELATED PARTS**

PART NUMBER	DESCRIPTION	COMMENTS
LT1616	500mA ( $I_{OUT}$ ), 1.4MHz, High Efficiency Step-Down DC/DC Converter	90% Efficiency, $V_{IN}$ = 3.6V to 25V, $V_{OUT}$ = 1.25V, $I_Q$ = 1.9mA, $I_{SD}$ = <1 $\mu$ A, ThinSOT Package
LT1676	450mA ( $I_{OUT}$ ), 100kHz, High Efficiency Step-Down DC/DC Converter	90% Efficiency, $V_{IN}$ = 7.4V to 60V, $V_{OUT}$ = 1.24V, $I_Q$ = 3.2mA, $I_{SD}$ = 2.5 $\mu$ A, S8 Package
LTC1701/LTC1701B	750mA ( $I_{OUT}$ ), 1MHz, High Efficiency Step-Down DC/DC Converter	90% Efficiency, $V_{IN}$ = 2.5V to 5V, $V_{OUT}$ = 1.25V, $I_Q$ = 135 $\mu$ A, $I_{SD}$ = 1 $\mu$ A, ThinSOT Package
LT1776	500mA ( $I_{OUT}$ ), 200kHz, High Efficiency Step-Down DC/DC Converter	90% Efficiency, $V_{IN}$ = 7.4V to 40V, $V_{OUT}$ = 1.24V, $I_Q$ = 3.2mA, $I_{SD}$ = 30 $\mu$ A, N8, S8 Packages
LTC1877	600mA ( $I_{OUT}$ ), 550kHz, Synchronous Step-Down DC/DC Converter	95% Efficiency, $V_{IN}$ = 2.7V to 10V, $V_{OUT}$ = 0.8V, $I_Q$ = 10 $\mu$ A, $I_{SD}$ = <1 $\mu$ A, MS8 Package
LTC1878	600mA ( $I_{OUT}$ ), 550kHz, Synchronous Step-Down DC/DC Converter	95% Efficiency, $V_{IN}$ = 2.7V to 6V, $V_{OUT}$ = 0.8V, $I_Q$ = 10 $\mu$ A, $I_{SD}$ = <1 $\mu$ A, MS8 Package
LTC1879	1.2A ( $I_{OUT}$ ), 550kHz, Synchronous Step-Down DC/DC Converter	95% Efficiency, $V_{IN}$ = 2.7V to 10V, $V_{OUT}$ = 0.8V, $I_Q$ = 15 $\mu$ A, $I_{SD}$ = <1 $\mu$ A, TSSOP-16 Package
LTC3403	600mA ( $I_{OUT}$ ), 1.5MHz, Synchronous Step-Down DC/DC Converter with Bypass Transistor	96% Efficiency, $V_{IN}$ = 2.5V to 5.5V, $V_{OUT}$ = Dynamically Adjustable, $I_Q$ = 20 $\mu$ A, $I_{SD}$ = <1 $\mu$ A, DFN Package
LTC3404	600mA ( $I_{OUT}$ ), 1.4MHz, Synchronous Step-Down DC/DC Converter	95% Efficiency, $V_{IN}$ = 2.7V to 6V, $V_{OUT}$ = 0.8V, $I_Q$ = 10 $\mu$ A, $I_{SD}$ = <1 $\mu$ A, MS8 Package
LTC3405/LTC3405A	300mA ( $I_{OUT}$ ), 1.5MHz, Synchronous Step-Down DC/DC Converter	96% Efficiency, $V_{IN}$ = 2.5V to 5.5V, $V_{OUT}$ = 0.8V, $I_Q$ = 20 $\mu$ A, $I_{SD}$ = <1 $\mu$ A, ThinSOT Package
LTC3406/LTC3406B	600mA ( $I_{OUT}$ ), 1.5MHz, Synchronous Step-Down DC/DC Converter	96% Efficiency, $V_{IN}$ = 2.5V to 5.5V, $V_{OUT}$ = 0.6V, $I_Q$ = 20 $\mu$ A, $I_{SD}$ = <1 $\mu$ A, ThinSOT Package
LTC3409	600mA ( $I_{OUT}$ ), 1.5MHz/2.25MHz, Synchronous Step-Down DC/DC Converter	95% Efficiency, $V_{IN}$ = 1.6V to 5.5V, $V_{OUT}$ = 0.613V, $I_Q$ = 65 $\mu$ A, DD8 Package
LTC3410/LTC3410B	300mA ( $I_{OUT}$ ), 2.25MHz, Synchronous Step-Down DC/DC Converter	96% Efficiency, $V_{IN}$ = 2.5V to 5.5V, $V_{OUT}$ = 0.8V, $I_Q$ = 26 $\mu$ A, SC70 Package
LTC3411	1.25A ( $I_{OUT}$ ), 4MHz, Synchronous Step-Down DC/DC Converter	95% Efficiency, $V_{IN}$ = 2.5V to 5.5V, $V_{OUT}$ = 0.8V, $I_Q$ = 60 $\mu$ A, $I_{SD}$ = <1 $\mu$ A, MS Package
LTC3412	2.5A ( $I_{OUT}$ ), 4MHz, Synchronous Step-Down DC/DC Converter	95% Efficiency, $V_{IN}$ = 2.5V to 5.5V, $V_{OUT}$ = 0.8V, $I_Q$ = 60 $\mu$ A, $I_{SD}$ = <1 $\mu$ A, TSSOP-16E Package
LTC3440	600mA ( $I_{OUT}$ ), 2MHz, Synchronous Buck-Boost DC/DC Converter	95% Efficiency, $V_{IN}$ = 2.5V to 5.5V, $V_{OUT}$ = 2.5V, $I_Q$ = 25 $\mu$ A, $I_{SD}$ = <1 $\mu$ A, MS Package

## Looking for pricing, stock, or lifecycle information?

Click below to explore more details on WIN SOURCE:

- ⊖ [View LTC3410ESC6-1.875#TRPBF on WIN SOURCE](#)
- ⊖ [Analog Devices Inc. Information](#)

## Optimize Your Supply Chain with WIN SOURCE Solutions

- ✓ Global Sourcing Solution
- ✓ Obsolete Management
- ✓ Cost Control Management
- ✓ Shortage Management
- ✓ Alternative Solution
- ✓ Excess Inventory Management