



**THE DATASHEET OF
NS10155T220MNV**



Notice for TAIYO YUDEN Products[For High Quality and/or Reliability Equipment
(Automotive Electronic Equipment / Industrial Equipment)]

Please read this notice before using the TAIYO YUDEN products.

 **REMINDERS**

- Product information in this catalog is as of October 2018. All of the contents specified herein are subject to change without notice due to technical improvements, etc. Therefore, please check for the latest information carefully before practical application or use of our products.

Please note that TAIYO YUDEN shall not be in any way responsible for any damages and defects in products or equipment incorporating our products, which are caused under the conditions other than those specified in this catalog or individual product specification sheets.

- Please contact TAIYO YUDEN for further details of product specifications as the individual product specification sheets are available.
- Please conduct validation and verification of our products in actual condition of mounting and operating environment before using our products.
- The products listed in this catalog are intended for use in general electronic equipment (e.g., AV equipment, OA equipment, home electric appliances, office equipment, information and communication equipment), medical equipment classified as Class I or II by IMDRF, industrial equipment, and automotive interior applications, etc. Please be sure to contact TAIYO YUDEN for further information before using the products for any equipment which may directly cause loss of human life or bodily injury (e.g., transportation equipment including, without limitation, automotive powertrain control system, train control system, and ship control system, traffic signal equipment, medical equipment classified as Class III by IMDRF).

Please do not incorporate our products into any equipment requiring high levels of safety and/or reliability (e.g., aerospace equipment, aviation equipment*, medical equipment classified as Class IV by IMDRF, nuclear control equipment, undersea equipment, military equipment).

*Note: There is a possibility that our products can be used only for aviation equipment that does not directly affect the safe operation of aircraft (e.g., in-flight entertainment, cabin light, electric seat, cooking equipment) if such use meets requirements specified separately by TAIYO YUDEN. Please be sure to contact TAIYO YUDEN for further information before using our products for such aviation equipment.

When our products are used even for high safety and/or reliability-required devices or circuits of general electronic equipment, it is strongly recommended to perform a thorough safety evaluation prior to use of our products and to install a protection circuit as necessary.

Please note that unless you obtain prior written consent of TAIYO YUDEN, TAIYO YUDEN shall not be in any way responsible for any damages incurred by you or third parties arising from use of the products listed in this catalog for any equipment requiring inquiry to TAIYO YUDEN or prohibited for use by TAIYO YUDEN as described above.

- Information contained in this catalog is intended to convey examples of typical performances and/or applications of our products and is not intended to make any warranty with respect to the intellectual property rights or any other related rights of TAIYO YUDEN or any third parties nor grant any license under such rights.
- Please note that the scope of warranty for our products is limited to the delivered our products themselves and TAIYO YUDEN shall not be in any way responsible for any damages resulting from a fault or defect in our products. Notwithstanding the foregoing, if there is a written agreement (e.g., supply and purchase agreement, quality assurance agreement) signed by TAIYO YUDEN and your company, TAIYO YUDEN will warrant our products in accordance with such agreement.
- The contents of this catalog are applicable to our products which are purchased from our sales offices or authorized distributors (hereinafter "TAIYO YUDEN's official sales channel"). Please note that the contents of this catalog are not applicable to our products purchased from any seller other than TAIYO YUDEN's official sales channel.

- **Caution for Export**

Some of our products listed in this catalog may require specific procedures for export according to "U.S. Export Administration Regulations", "Foreign Exchange and Foreign Trade Control Law" of Japan, and other applicable regulations. Should you have any questions on this matter, please contact our sales staff.

Automotive Application Guide

We classify automotive electronic equipment into the following four application categories and set usable application categories for each of our products. When using our products for automotive electronic equipment, please be sure to check such application categories and use our products accordingly. Should you have any questions on this matter, please contact us.

Category	Automotive Electronic Equipment (Typical Example)
POWERTRAIN	<ul style="list-style-type: none"> • Engine ECU (Electronically Controlled Fuel Injector) • Cruise Control Unit • 4WS (4 Wheel Steering) • Automatic Transmission • Power Steering • HEV/PHV/EV Core Control (Battery, Inverter, DC-DC) • Automotive Locator (Car location information providing device), etc.
SAFETY	<ul style="list-style-type: none"> • ABS (Anti-Lock Brake System) • ESC (Electronic Stability Control) • Airbag • ADAS (Equipment that directly controls running, turning and stopping), etc.
BODY & CHASSIS	<ul style="list-style-type: none"> • Wiper • Automatic Door • Power Window • Keyless Entry System • Electric Door Mirror • Interior Lighting • LED Headlight • TPMS (Tire Pressure Monitoring System) • Anti-Theft Device (Immobilizer), etc.
INFOTAINMENT	<ul style="list-style-type: none"> • Car Infotainment System • ITS/Telematics System • Instrument Cluster • ADAS (Sensor, Equipment that is not interlocked with safety equipment or powertrain), etc.

SMD POWER INDUCTORS(NS SERIES)



REFLOW
AEC-Q200

AEC-Q200 Grade 3 (we conduct the evaluation at the test condition of Grade 3.)

*Operating environment Temp:-40~85°C

■ PART NUMBER

*Operating Temp. : -40~125°C (Including self-generated heat)

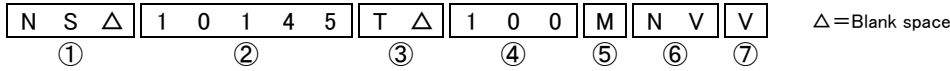

① Series name

Code	Series name
NS△	SMD inductor

② Dimensions (L × W × H)

Code	Dimensions (L × W × H) [mm]
10145	10.1 × 10.1 × 4.5
10155	10.1 × 10.1 × 5.5
10165	10.1 × 10.1 × 6.5
12555	12.5 × 12.5 × 5.5
12565	12.5 × 12.5 × 6.5
12575	12.5 × 12.5 × 7.5

③ Packaging

Code	Packaging
T△	Taping

④ Nominal inductance

Code (example)	Nominal inductance [μH]
1R0	1.0
100	10
101	100

※R=Decimal point

⑤ Inductance tolerance

Code	Inductance tolerance
M	±20%
N	±30%

⑥ Special code

Code	Special code
N△	125 type standard
NV	101 type standard

⑦ Internal code

Code	Internal code
V	Inductor for Industrial and Automotive

■ STANDARD EXTERNAL DIMENSIONS / MINIMUM QUANTITY

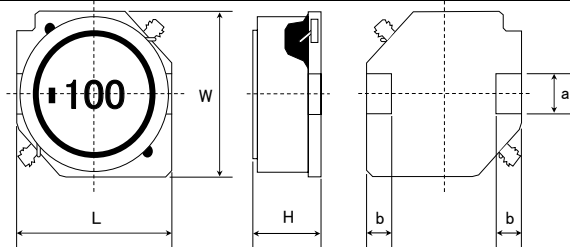

Type	L	W	H	a	b	Minimum quantity [pcs]
NS 10145	10.1±0.3 (0.398±0.012)	10.1±0.3 (0.398±0.012)	4.5±0.35 (0.177±0.014)	2.8±0.1 (0.110±0.004)	2.0±0.15 (0.079±0.006)	2000
NS 10155	10.1±0.3 (0.398±0.012)	10.1±0.3 (0.398±0.012)	5.5±0.35 (0.217±0.014)	2.8±0.1 (0.110±0.004)	2.0±0.15 (0.079±0.006)	2000
NS 10165	10.1±0.3 (0.398±0.012)	10.1±0.3 (0.398±0.012)	6.5±0.35 (0.256±0.014)	2.8±0.1 (0.110±0.004)	2.0±0.15 (0.079±0.006)	2000
NS 12555	12.5±0.3 (0.492±0.012)	12.5±0.3 (0.492±0.012)	5.5±0.35 (0.217±0.014)	3.0±0.1 (0.118±0.004)	2.0±0.15 (0.079±0.006)	2000
NS 12565	12.5±0.3 (0.492±0.012)	12.5±0.3 (0.492±0.012)	6.5±0.35 (0.256±0.014)	3.0±0.1 (0.118±0.004)	2.0±0.15 (0.079±0.006)	2000
NS 12575	12.5±0.3 (0.492±0.012)	12.5±0.3 (0.492±0.012)	7.5±0.35 (0.295±0.014)	3.0±0.1 (0.118±0.004)	2.0±0.15 (0.079±0.006)	2000

Unit: mm (inch)

Recommended Land Patterns

Surface Mounting

- Mounting and soldering conditions should be checked beforehand.
- Applicable soldering process to these products is reflow soldering only.

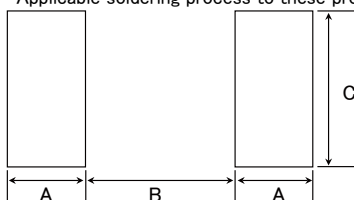

Type	A	B	C
NS 10145	2.5	5.6	3.2
NS 10155	2.5	5.6	3.2
NS 10165	2.5	5.6	3.2
NS 12555	2.5	8.6	3.2
NS 12565	2.5	8.6	3.2
NS 12575	2.5	8.6	3.2

Unit: mm

► This catalog contains the typical specification only due to the limitation of space. When you consider the purchase of our products, please check our product specification sheets. For details of each product (characteristics graph, reliability information, precautions for use, and so on), see our website (<http://www.ty-top.com/>).

■ PART NUMBER

• All the SMD Power Inductors of the catalog lineup are RoHS compliant.

Note)

- The exchange of individual specifications is necessary depending on the application and circuit condition. Please contact Taiyo Yuden sales channels.
- *1: Automotive (AEC-Q200 Qualified) products for BODY & CHASSIS, and INFOTAINMENT. Please check "Automotive Application Guide" for further details before using the products.
 < AEC-Q200 :AEC-Q200 qualified>
 All the SMD Power Inductors of *1 marks are tested based on the test conditions and methods defined in AEC-Q200 by family item.
 Please consult with TAIYO YUDEN's official sales channel for the details of the product specification and AEC-Q200 test results, etc.,
 and please review and approve TAIYO YUDEN's product specification before ordering.
- *2: Industrial products and Medical products

● NS 10145 type

Part number	Nominal inductance [μH]	Inductance tolerance	DC Resistance [Ω] (±20%)	Rated current ※) [A]		Measuring frequency[kHz]	Note
				Saturation current Idc1	Temperature rise current Idc2		
NS 10145T 1R0NNVV	1.0	±30%	0.0049	12.54	8.90	100	*1,*2
NS 10145T 1R5NNVV	1.5	±30%	0.0060	10.34	7.99	100	*1,*2
NS 10145T 2R2NNVV	2.2	±30%	0.0085	8.91	6.64	100	*1,*2
NS 10145T 3R3NNVV	3.3	±30%	0.0100	7.33	6.10	100	*1,*2
NS 10145T 4R7NNVV	4.7	±30%	0.0144	6.69	5.03	100	*1,*2
NS 10145T 5R6NNVV	5.6	±30%	0.0181	5.85	4.45	100	*1,*2
NS 10145T 6R8NNVV	6.8	±30%	0.0230	5.05	4.22	100	*1,*2
NS 10145T 100MNVV	10	±20%	0.0270	4.22	3.10	100	*1,*2
NS 10145T 150MNVV	15	±20%	0.0381	3.44	3.00	100	*1,*2
NS 10145T 220MNVV	22	±20%	0.0570	2.87	2.30	100	*1,*2
NS 10145T 330MNVV	33	±20%	0.0880	2.36	1.90	100	*1,*2
NS 10145T 470MNVV	47	±20%	0.130	2.00	1.50	100	*1,*2
NS 10145T 680MNVV	68	±20%	0.150	1.66	1.45	100	*1,*2
NS 10145T 101MNVV	100	±20%	0.230	1.40	1.10	100	*1,*2
NS 10145T 151MNVV	150	±20%	0.350	1.11	0.86	100	*1,*2
NS 10145T 221MNVV	220	±20%	0.510	0.91	0.78	100	*1,*2
NS 10145T 331MNVV	330	±20%	0.700	0.71	0.64	100	*1,*2
NS 10145T 471MNVV	470	±20%	1.03	0.61	0.52	100	*1,*2
NS 10145T 681MNVV	680	±20%	1.57	0.50	0.42	100	*1,*2
NS 10145T 102MNVV	1000	±20%	2.58	0.41	0.32	100	*1,*2
NS 10145T 152MNVV	1500	±20%	3.70	0.36	0.27	100	*1,*2

● NS 10155 type

Part number	Nominal inductance [μH]	Inductance tolerance	DC Resistance [Ω] (±20%)	Rated current ※) [A]		Measuring frequency[kHz]	Note
				Saturation current Idc1	Temperature rise current Idc2		
NS 10155T 1R5NNVV	1.5	±30%	0.0060	11.90	8.39	100	*1,*2
NS 10155T 2R2NNVV	2.2	±30%	0.0072	10.00	7.61	100	*1,*2
NS 10155T 3R3NNVV	3.3	±30%	0.0097	8.50	6.49	100	*1,*2
NS 10155T 4R7NNVV	4.7	±30%	0.0112	7.40	6.01	100	*1,*2
NS 10155T 6R8NNVV	6.8	±30%	0.0159	6.00	4.98	100	*1,*2
NS 10155T 100MNVV	10	±20%	0.0200	4.49	4.40	100	*1,*2
NS 10155T 150MNVV	15	±20%	0.0310	4.03	3.40	100	*1,*2
NS 10155T 220MNVV	22	±20%	0.0430	3.37	2.80	100	*1,*2

● NS 10165 type

Part number	Nominal inductance [μH]	Inductance tolerance	DC Resistance [Ω] (±20%)	Rated current ※) [A]		Measuring frequency[kHz]	Note
				Saturation current Idc1	Temperature rise current Idc2		
NS 10165T 1R5NNVV	1.5	±30%	0.0062	13.60	8.04	100	*1,*2
NS 10165T 2R2NNVV	2.2	±30%	0.0074	10.80	7.32	100	*1,*2
NS 10165T 3R3NNVV	3.3	±30%	0.0086	9.30	6.76	100	*1,*2
NS 10165T 4R7NNVV	4.7	±30%	0.0112	7.70	5.88	100	*1,*2
NS 10165T 6R8NNVV	6.8	±30%	0.0140	6.00	5.22	100	*1,*2
NS 10165T 100MNVV	10	±20%	0.0174	5.20	4.66	100	*1,*2
NS 10165T 150MNVV	15	±20%	0.0280	3.60	3.84	100	*1,*2
NS 10165T 220MNVV	22	±20%	0.0350	3.10	3.41	100	*1,*2

※) The saturation current value (Idc1) is the DC current value having inductance decrease down to 30%. (at 20°C)
 ※) The temperature rise current value (Idc2) is the DC current value having temperature increase up to 40°C. (at 20°C)
 ※) The rated current is the DC current value that satisfies both of current value saturation current value and temperature rise current value.

■ PART NUMBER

● NS 12555 type

Part number	Nominal inductance [μH]	Inductance tolerance	DC Resistance [Ω] (±20%)	Rated current ※) [A]		Measuring frequency [kHz]	Note
				Saturation current Idc1	Temperature rise current Idc2		
NS 12555T 6R0NN V	6.0	±30%	0.0140	5.01	5.60	100	*1 *2
NS 12555T 100MN V	10	±20%	0.0175	4.73	5.04	100	*1 *2
NS 12555T 150MN V	15	±20%	0.0233	3.89	4.18	100	*1 *2
NS 12555T 220MN V	22	±20%	0.0297	3.20	3.81	100	*1 *2
NS 12555T 330MN V	33	±20%	0.0415	2.64	3.16	100	*1 *2
NS 12555T 470MN V	47	±20%	0.0618	2.23	2.70	100	*1 *2
NS 12555T 680MN V	68	±20%	0.0832	1.81	2.14	100	*1 *2
NS 12555T 101MN V	100	±20%	0.117	1.53	1.86	100	*1 *2
NS 12555T 151MN V	150	±20%	0.215	1.10	1.30	100	*1 *2
NS 12555T 221MN V	220	±20%	0.270	1.00	1.18	100	*1 *2
NS 12555T 331MN V	330	±20%	0.410	0.82	0.96	100	*1 *2
NS 12555T 471MN V	470	±20%	0.520	0.68	0.80	100	*1 *2
NS 12555T 681MN V	680	±20%	0.870	0.48	0.61	100	*1 *2
NS 12555T 102MN V	1000	±20%	1.44	0.41	0.46	100	*1 *2
NS 12555T 152MN V	1500	±20%	1.73	0.40	0.44	100	*1 *2

● NS 12565 type

Part number	Nominal inductance [μH]	Inductance tolerance	DC Resistance [Ω] (±20%)	Rated current ※) [A]		Measuring frequency [kHz]	Note
				Saturation current Idc1	Temperature rise current Idc2		
NS 12565T 2R0NN V	2.0	±30%	0.0080	13.91	7.60	100	*1 *2
NS 12565T 4R2NN V	4.2	±30%	0.0126	9.40	5.91	100	*1 *2
NS 12565T 7R0NN V	7.0	±30%	0.0162	7.80	5.21	100	*1 *2
NS 12565T 100MN V	10	±20%	0.0199	6.00	4.75	100	*1 *2
NS 12565T 150MN V	15	±20%	0.0237	5.60	4.33	100	*1 *2
NS 12565T 220MN V	22	±20%	0.0310	4.20	3.91	100	*1 *2
NS 12565T 330MN V	33	±20%	0.0390	3.80	3.22	100	*1 *2
NS 12565T 470MN V	47	±20%	0.0575	3.34	2.78	100	*1 *2
NS 12565T 680MN V	68	±20%	0.0775	2.70	2.30	100	*1 *2
NS 12565T 101MN V	100	±20%	0.123	2.23	1.81	100	*1 *2
NS 12565T 151MN V	150	±20%	0.173	1.80	1.54	100	*1 *2
NS 12565T 221MN V	220	±20%	0.273	1.39	1.18	100	*1 *2

● NS 12575 type

Part number	Nominal inductance [μH]	Inductance tolerance	DC Resistance [Ω] (±20%)	Rated current ※) [A]		Measuring frequency [kHz]	Note
				Saturation current Idc1	Temperature rise current Idc2		
NS 12575T 1R2NN V	1.2	±30%	0.0058	18.08	9.15	100	*1 *2
NS 12575T 2R7NN V	2.7	±30%	0.0085	13.91	7.69	100	*1 *2
NS 12575T 3R9NN V	3.9	±30%	0.0099	12.10	7.38	100	*1 *2
NS 12575T 5R6NN V	5.6	±30%	0.0116	10.20	6.36	100	*1 *2
NS 12575T 6R8NN V	6.8	±30%	0.0131	9.50	5.84	100	*1 *2
NS 12575T 100MN V	10	±20%	0.0156	7.65	5.55	100	*1 *2
NS 12575T 150MN V	15	±20%	0.0184	6.30	5.22	100	*1 *2
NS 12575T 220MN V	22	±20%	0.0260	5.50	4.05	100	*1 *2
NS 12575T 330MN V	33	±20%	0.0390	4.30	3.48	100	*1 *2
NS 12575T 470MN V	47	±20%	0.0515	3.60	2.95	100	*1 *2
NS 12575T 680MN V	68	±20%	0.0900	2.78	2.10	100	*1 *2
NS 12575T 101MN V	100	±20%	0.110	2.50	2.01	100	*1 *2
NS 12575T 151MN V	150	±20%	0.161	1.90	1.51	100	*1 *2
NS 12575T 221MN V	220	±20%	0.300	1.60	1.10	100	*1 *2
NS 12575T 102MN V	1000	±20%	1.170	0.72	0.53	100	*1 *2

※) The saturation current value (Idc1) is the DC current value having inductance decrease down to 30%. (at 20°C)

※) The temperature rise current value (Idc2) is the DC current value having temperature increase up to 40°C. (at 20°C)

※) The rated current is the DC current value that satisfies both of current value saturation current value and temperature rise current value.

■ Derating of Rated Current

● NS series

Derating of current is necessary for NS series depending on ambient temperature. Please refer to the chart shown below for appropriate derating of current.

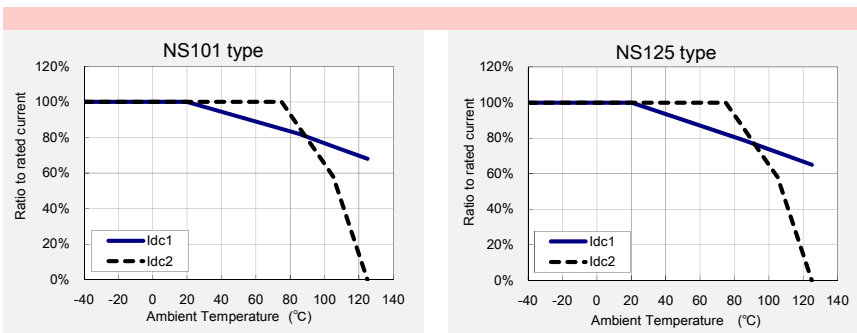

▶ This catalog contains the typical specification only due to the limitation of space. When you consider the purchase of our products, please check our product specification sheets. For details of each product (characteristics graph, reliability information, precautions for use, and so on), see our website (<http://www.ty-top.com/>).

SMD POWER INDUCTORS (NS SERIES)

PACKAGING

① Packing Quantity

Type	Standard Quantity (1reel) [pcs]	Minimum Quantity [pcs]
	Embossed Tape	Embossed Tape
NS10145	500	2000
NS10155	500	2000
NS10165	500	2000
NS12555	500	2000
NS12565	500	2000
NS12575	500	2000

② Tape Material

● Embossed Tape

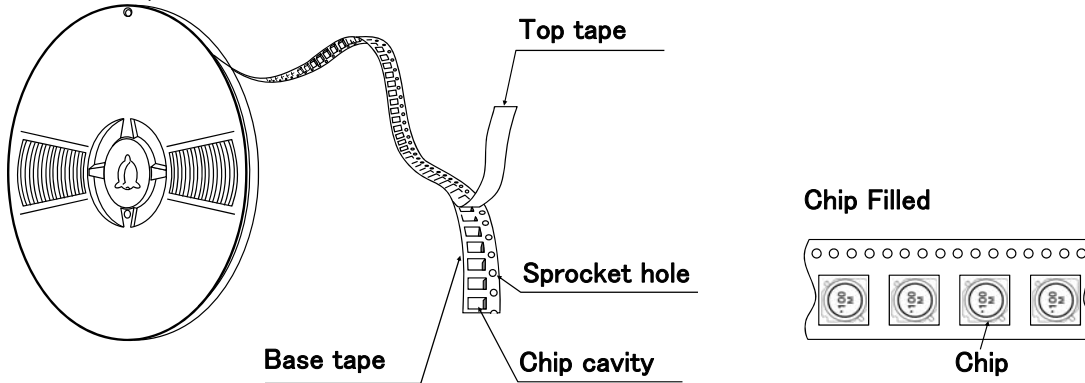

③ Taping dimensions

● Embossed tape 24mm wide (0.945 inches wide)

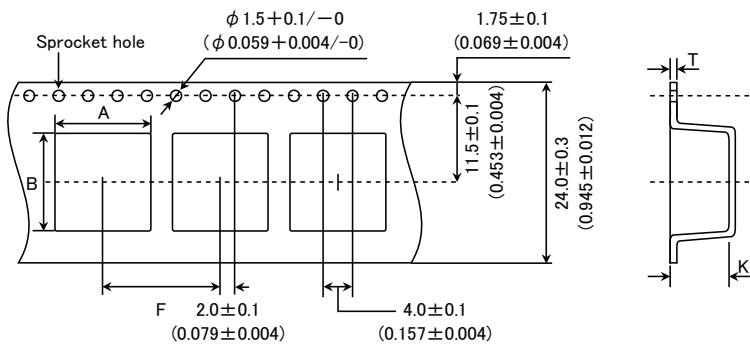

Type	Chip cavity		Insertion pitch	Tape thickness	
	A	B	F	T	K
NS10145	10.5 ± 0.1 (0.413 ± 0.004)	10.5 ± 0.1 (0.413 ± 0.004)	16.0 ± 0.1 (0.630 ± 0.004)	0.4 ± 0.1 (0.016 ± 0.004)	5.0 ± 0.1 (0.197 ± 0.004)
NS10155	10.5 ± 0.1 (0.413 ± 0.004)	10.5 ± 0.1 (0.413 ± 0.004)	16.0 ± 0.1 (0.630 ± 0.004)	0.4 ± 0.1 (0.016 ± 0.004)	6.0 ± 0.1 (0.236 ± 0.004)
NS10165	10.5 ± 0.1 (0.413 ± 0.004)	10.5 ± 0.1 (0.413 ± 0.004)	16.0 ± 0.1 (0.630 ± 0.004)	0.4 ± 0.1 (0.016 ± 0.004)	7.0 ± 0.1 (0.276 ± 0.004)
NS12555	13.0 ± 0.1 (0.512 ± 0.004)	13.0 ± 0.1 (0.512 ± 0.004)	16.0 ± 0.1 (0.630 ± 0.004)	0.4 ± 0.1 (0.016 ± 0.004)	6.1 ± 0.1 (0.240 ± 0.004)
NS12565	13.0 ± 0.1 (0.512 ± 0.004)	13.0 ± 0.1 (0.512 ± 0.004)	16.0 ± 0.1 (0.630 ± 0.004)	0.4 ± 0.1 (0.016 ± 0.004)	7.1 ± 0.1 (0.280 ± 0.004)
NS12575	13.0 ± 0.1 (0.512 ± 0.004)	13.0 ± 0.1 (0.512 ± 0.004)	16.0 ± 0.1 (0.630 ± 0.004)	0.4 ± 0.1 (0.016 ± 0.004)	8.0 ± 0.1 (0.315 ± 0.004)

Unit : mm (inch)

▶ This catalog contains the typical specification only due to the limitation of space. When you consider the purchase of our products, please check our specification. For details of each product (characteristics graph, reliability information, precautions for use, and so on), see our Web site (<http://www.ty-top.com/>).

④ Leader and Blank portion

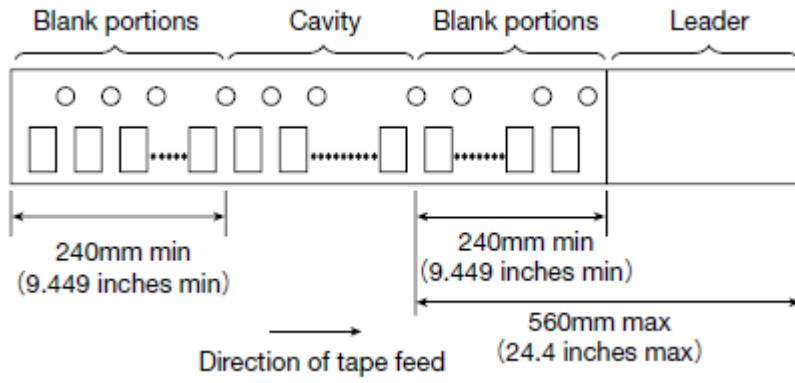

⑤ Reel size

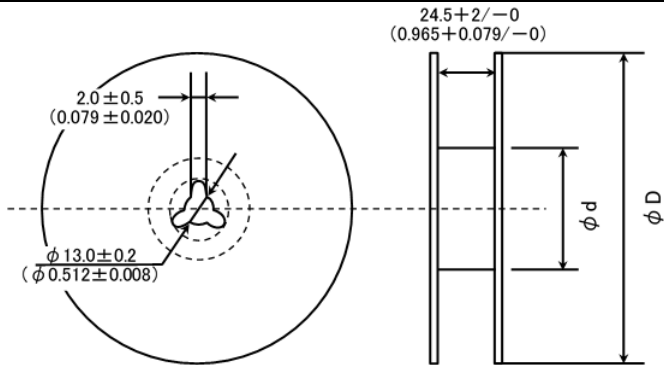

Type	Reel size (Reference values)	
	ϕD	ϕd
NS10145	330 ± 2 (12.99 ± 0.079)	100 ± 1 (3.937 ± 0.039)
NS10155		
NS10165		
NS12555		
NS12565		
NS12575		

Unit: mm (inch)

⑥ Top Tape Strength

The top tape requires a peel-off force of 0.1 to 1.3N in the direction of the arrow as illustrated below.

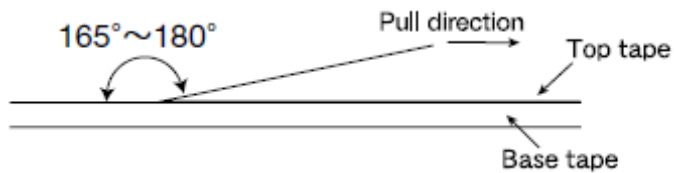

SMD POWER INDUCTORS (NS SERIES)

RELIABILITY DATA

1. Operating Temperature Range														
Specified Value	NS101, NS125 Type	-40~+125°C (Including self-generated heat)												
Test Methods and Remarks	Including self-generated heat													
2. Storage Temperature Range														
Specified Value	NS101, NS125 Type	-40~+85°C												
Test Methods and Remarks	-5 to 40°C for the product with taping.													
3. Rated current														
Specified Value	NS101, NS125 Type	Within the specified tolerance												
4. Inductance														
Specified Value	NS101, NS125 Type	Within the specified tolerance												
Test Methods and Remarks	Measuring equipment : LCR Meter (HP 4285A or equivalent) Measuring frequency : 100kHz, 1V													
5. DC Resistance														
Specified Value	NS101, NS125 Type	Within the specified tolerance												
Test Methods and Remarks	Measuring equipment : DC ohmmeter (HIOKI 3227 or equivalent)													
6. Self resonance frequency														
Specified Value	NS101, NS125 Type	—												
7. Temperature characteristic														
Specified Value	NS101, NS125 Type	Inductance change : Within ±15%												
Test Methods and Remarks	NS101, NS125 Type : Measurement of inductance shall be taken at temperature range within -40°C~+125°C. With reference to inductance value at +20°C., change rate shall be calculated. Change of maximum inductance deviation in step 1 to 5													
	<table border="1"> <thead> <tr> <th>Step</th> <th>Temperature(°C)</th> </tr> </thead> <tbody> <tr> <td>1</td> <td>20</td> </tr> <tr> <td>2</td> <td>Minimum operating temperature</td> </tr> <tr> <td>3</td> <td>20 (Standard temperature)</td> </tr> <tr> <td>4</td> <td>Maximum operating temperature</td> </tr> <tr> <td>5</td> <td>20</td> </tr> </tbody> </table>	Step	Temperature(°C)	1	20	2	Minimum operating temperature	3	20 (Standard temperature)	4	Maximum operating temperature	5	20	
Step	Temperature(°C)													
1	20													
2	Minimum operating temperature													
3	20 (Standard temperature)													
4	Maximum operating temperature													
5	20													

▶ This catalog contains the typical specification only due to the limitation of space. When you consider the purchase of our products, please check our specification.
 For details of each product (characteristics graph, reliability information, precautions for use, and so on), see our Web site (<http://www.ty-top.com/>).

8. Resistance to flexure of substrate														
Specified Value	NS101, NS125 Type	No damage												
Test Methods and Remarks	<p>The test samples shall be soldered to the test board by the reflow. As illustrated below, apply force in the direction of the arrow indicating until deflection of the test board reaches to 2 mm.</p> <p>Test board size : 100 × 40 × 1.0 Test board material : glass epoxy-resin Solder cream thickness : 0.15 mm(NS101/125Type)</p>													
	<p>Land dimension</p>	<table border="1"> <thead> <tr> <th>Type</th> <th>A</th> <th>B</th> <th>C</th> </tr> </thead> <tbody> <tr> <td>NS101</td> <td>2.5</td> <td>5.6</td> <td>3.2</td> </tr> <tr> <td>NS125</td> <td>2.5</td> <td>8.6</td> <td>3.2</td> </tr> </tbody> </table>	Type	A	B	C	NS101	2.5	5.6	3.2	NS125	2.5	8.6	3.2
Type	A	B	C											
NS101	2.5	5.6	3.2											
NS125	2.5	8.6	3.2											

9. Insulation resistance : between wires		
Specified Value	NS101, NS125 Type	—

10. Insulation resistance : between wire and core		
Specified Value	NS101, NS125 Type	—

11. Withstanding voltage : between wire and core		
Specified Value	NS101, NS125 Type	—

12. Adhesion of terminal electrode		
Specified Value	NS101, NS125 Type	Shall not come off PC board
Test Methods and Remarks	<p>The test samples shall be soldered to the test board by the reflow.</p> <p>Applied force : 10N to X and Y directions. Duration : 5s. Solder cream thickness : 0.15mm(NS101/125Type)</p>	

13. Resistance to vibration																
Specified Value	NS101, NS125 Type	Inductance change : Within ±10% No significant abnormality in appearance.														
Test Methods and Remarks	<p>The test samples shall be soldered to the test board by the reflow. Then it shall be submitted to below test conditions.</p> <table border="1"> <tr> <td>Frequency Range</td> <td colspan="2">10~55Hz</td> </tr> <tr> <td>Total Amplitude</td> <td colspan="2">1.5mm (May not exceed acceleration 196m/s²)</td> </tr> <tr> <td>Sweeping Method</td> <td colspan="2">10Hz to 55Hz to 10Hz for 1min.</td> </tr> <tr> <td rowspan="3">Time</td> <td>X</td> <td rowspan="3">For 2 hours on each X, Y, and Z axis.</td> </tr> <tr> <td>Y</td> </tr> <tr> <td>Z</td> </tr> </table> <p>Recovery : At least 2hrs of recovery under the standard condition after the test, followed by the measurement within 48hrs.</p>		Frequency Range	10~55Hz		Total Amplitude	1.5mm (May not exceed acceleration 196m/s ²)		Sweeping Method	10Hz to 55Hz to 10Hz for 1min.		Time	X	For 2 hours on each X, Y, and Z axis.	Y	Z
	Frequency Range	10~55Hz														
Total Amplitude	1.5mm (May not exceed acceleration 196m/s ²)															
Sweeping Method	10Hz to 55Hz to 10Hz for 1min.															
Time	X	For 2 hours on each X, Y, and Z axis.														
	Y															
	Z															

14. Solderability					
Specified Value	NS101, NS125 Type	At least 90% of surface of terminal electrode is covered by new solder.			
Test Methods and Remarks	<p>The test samples shall be dipped in flux, and then immersed in molten solder as shown in below table.</p> <p>Flux : Methanol solution containing rosin 25%.</p>				
	<table border="1"> <tr> <td>Solder Temperature</td> <td>245 ± 5°C</td> </tr> <tr> <td>Time</td> <td>5 ± 1.0 sec.</td> </tr> </table> <p>※Immersion depth : All sides of mounting terminal shall be immersed.</p>		Solder Temperature	245 ± 5°C	Time
Solder Temperature	245 ± 5°C				
Time	5 ± 1.0 sec.				

▶ This catalog contains the typical specification only due to the limitation of space. When you consider the purchase of our products, please check our specification.
 For details of each product (characteristics graph, reliability information, precautions for use, and so on), see our Web site (<http://www.ty-top.com/>).

15. Resistance to soldering heat																				
Specified Value	NS101, NS125 Type	Inductance change : Within $\pm 10\%$ No significant abnormality in appearance.																		
Test Methods and Remarks	<p>The test sample shall be exposed to reflow oven at $230\pm 5^{\circ}\text{C}$ for 40 seconds, with peak temperature at $260\pm 5^{\circ}\text{C}$ for 5 seconds, 2 times.</p> <p>Test board material : glass epoxy-resin Test board thickness : 1.0mm Recovery : At least 2hrs of recovery under the standard condition after the test, followed by the measurement within 48hrs.</p>																			
16. Thermal shock																				
Specified Value	NS101, NS125 Type	Inductance change : Within $\pm 10\%$ No significant abnormality in appearance.																		
Test Methods and Remarks	<p>The test samples shall be soldered to the test board by the reflow. The test samples shall be placed at specified temperature for specified time by step 1 to step 4 as shown in below table in sequence. The temperature cycle shall be repeated 100 cycles.</p> <table border="1"> <thead> <tr> <th colspan="3">Conditions of 1 cycle</th> </tr> <tr> <th>Step</th> <th>Temperature ($^{\circ}\text{C}$)</th> <th>Duration (min)</th> </tr> </thead> <tbody> <tr> <td>1</td> <td>-40 ± 3</td> <td>30 ± 3</td> </tr> <tr> <td>2</td> <td>Room temperature</td> <td>Within 3</td> </tr> <tr> <td>3</td> <td>$+85\pm 2$</td> <td>30 ± 3</td> </tr> <tr> <td>4</td> <td>Room temperature</td> <td>Within 3</td> </tr> </tbody> </table> <p>Recovery : At least 2hrs of recovery under the standard condition after the test, followed by the measurement within 48hrs.</p>		Conditions of 1 cycle			Step	Temperature ($^{\circ}\text{C}$)	Duration (min)	1	-40 ± 3	30 ± 3	2	Room temperature	Within 3	3	$+85\pm 2$	30 ± 3	4	Room temperature	Within 3
Conditions of 1 cycle																				
Step	Temperature ($^{\circ}\text{C}$)	Duration (min)																		
1	-40 ± 3	30 ± 3																		
2	Room temperature	Within 3																		
3	$+85\pm 2$	30 ± 3																		
4	Room temperature	Within 3																		
17. Damp heat																				
Specified Value	NS101, NS125 Type	Inductance change : Within $\pm 10\%$ No significant abnormality in appearance.																		
Test Methods and Remarks	<p>The test samples shall be soldered to the test board by the reflow. The test samples shall be placed in thermostatic oven set at specified temperature and humidity as shown in below table.</p> <table border="1"> <tbody> <tr> <td>Temperature</td> <td>$60\pm 2^{\circ}\text{C}$</td> </tr> <tr> <td>Humidity</td> <td>90~95%RH</td> </tr> <tr> <td>Time</td> <td>500+24/-0 hour</td> </tr> </tbody> </table> <p>Recovery : At least 2hrs of recovery under the standard condition after the test, followed by the measurement within 48hrs.</p>		Temperature	$60\pm 2^{\circ}\text{C}$	Humidity	90~95%RH	Time	500+24/-0 hour												
Temperature	$60\pm 2^{\circ}\text{C}$																			
Humidity	90~95%RH																			
Time	500+24/-0 hour																			
18. Loading under damp heat																				
Specified Value	NS101, NS125 Type	Inductance change : Within $\pm 10\%$ No significant abnormality in appearance.																		
Test Methods and Remarks	<p>The test samples shall be soldered to the test board by the reflow. The test samples shall be placed in thermostatic oven set at specified temperature and humidity and applied the rated current continuously as shown in below table.</p> <table border="1"> <tbody> <tr> <td>Temperature</td> <td>$60\pm 2^{\circ}\text{C}$</td> </tr> <tr> <td>Humidity</td> <td>90~95%RH</td> </tr> <tr> <td>Applied current</td> <td>Rated current</td> </tr> <tr> <td>Time</td> <td>500+24/-0 hour</td> </tr> </tbody> </table> <p>Recovery : At least 2hrs of recovery under the standard condition after the test, followed by the measurement within 48hrs.</p>		Temperature	$60\pm 2^{\circ}\text{C}$	Humidity	90~95%RH	Applied current	Rated current	Time	500+24/-0 hour										
Temperature	$60\pm 2^{\circ}\text{C}$																			
Humidity	90~95%RH																			
Applied current	Rated current																			
Time	500+24/-0 hour																			
19. Low temperature life test																				
Specified Value	NS101, NS125 Type	Inductance change : Within $\pm 10\%$ No significant abnormality in appearance.																		
Test Methods and Remarks	<p>The test samples shall be soldered to the test board by the reflow. After that, the test samples shall be placed at test conditions as shown in below table.</p> <table border="1"> <tbody> <tr> <td>Temperature</td> <td>$-40\pm 2^{\circ}\text{C}$</td> </tr> <tr> <td>Time</td> <td>500+24/-0 hour</td> </tr> </tbody> </table> <p>Recovery : At least 2hrs of recovery under the standard condition after the test, followed by the measurement within 48hrs.</p>		Temperature	$-40\pm 2^{\circ}\text{C}$	Time	500+24/-0 hour														
Temperature	$-40\pm 2^{\circ}\text{C}$																			
Time	500+24/-0 hour																			
20. High temperature life test																				
Specified Value	NS101, NS125 Type	—																		

21. Loading at high temperature life test		
Specified Value	NS101, NS125 Type	Inductance change : Within $\pm 10\%$ No significant abnormality in appearance.
Test Methods and Remarks	The test samples shall be soldered to the test board by the reflow soldering.	
	Temperature	$85 \pm 2^\circ\text{C}$
	Applied current	Rated current
	Time	$500 + 24 / - 0$ hour
Recovery : At least 2hrs of recovery under the standard condition after the test, followed by the measurement within 48hrs.		

22. Standard condition		
Specified Value	NS101, NS125 Type	Standard test condition : Unless otherwise specified, temperature is $20 \pm 15^\circ\text{C}$ and $65 \pm 20\%$ of relative humidity. When there is any question concerning measurement result: In order to provide correlation data, the test shall be condition of $20 \pm 2^\circ\text{C}$ of temperature, $65 \pm 5\%$ relative humidity. Inductance is in accordance with our measured value.

SMD POWER INDUCTORS (NR, NS, ES SERIES)

PRECAUTIONS

1. Circuit Design

Precautions	<p>◆ Operating environment</p> <p>1. The products listed in this catalogue are intended for use in general electronic equipment (e.g., AV equipment, OA equipment, home electric appliances, office equipment, information and communication equipment), general medical equipment, industrial equipment, and automotive interior applications, etc.</p> <p>Please be sure to contact TAIYO YUDEN for further information before using the products for any equipment which may directly cause loss of human life or bodily injury (e.g., specially controlled medical equipment, transportation equipment including, without limitation, automotive powertrain control system, train control system, and ship control system, traffic signal equipment).</p> <p>Please do not incorporate our products into any equipment requiring high levels of safety and/or reliability (e.g., aerospace equipment, aviation equipment, nuclear control equipment, undersea equipment, military equipment, etc.).</p>
-------------	---

2. PCB Design

Precautions	<p>◆ Land pattern design</p> <ol style="list-style-type: none"> Please refer to a recommended land pattern. There is stress, which has been caused by distortion of a PCB, to the inductor. (NRV20/30, NRH24/30, NRS20/30/40/50/60/80, NRM60 Type) Please consider the arrangement of parts on a PCB. (NRV20/30, NRH24/30, NRS20/30/40/50/60/80, NRM60 Type)
-------------	---

Technical considerations	<p>◆ Land pattern design</p> <p>Surface Mounting</p> <ol style="list-style-type: none"> Mounting and soldering conditions should be checked beforehand. Applicable soldering process to this products is reflow soldering only. Please use the recommended land pattern shown as below. Electrical characteristics and the mounting ability of the product are being considered in the recommended land pattern. If a PCB is designed with other dimensions, defective soldering and stress to a product may occur due to misalignment. The performance of the product may not be brought out. If an adopted land pattern is different from the recommended land pattern, stress to the product will increase. It may cause cracks or defective electrical characteristics of the product. Please conduct validation completely before studying adoption of this product and please judge the pros and cons of adoption of this product with taking on responsibility. (NR30/40/50/60/80, NRV20/30, NRH24/30, NRS20/30/40/50/60/80, NRM60 Type) As coefficients of thermal expansion between an inductor and a PCB differs, cracks may occur on a ferrite core when thermal stress is applied to them after mounting an inductor. (Please refer to the drawings below.) Please conduct validation completely before studying adoption of this product and please judge the pros and cons of adoption of this product with taking on responsibility. (NRV20/30, NRH24/30, NRS20/30/40/50/60/80, NRM60 Type)
--------------------------	--

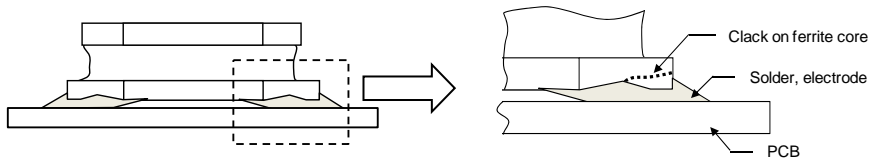

- SMD inductors should be located to minimize any possible mechanical stresses from board warp or deflection. When splitting the PCB after mounting inductors and other components, care is required so as not to give any stresses of deflection or twisting to the board. (NRV20/30, NRH24/30, NRS20/30/40/50/60/80, NRM60 Type)

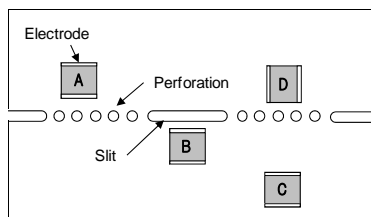

A product tends to undergo stress in order "A>C>B≡D".
Please consider the layouts of a product to minimize any stresses.

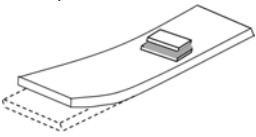
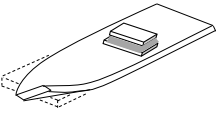
3. Considerations for automatic placement	
Precautions	<p>◆Adjustment of mounting machine</p> <ol style="list-style-type: none"> Excessive impact load should not be imposed on the products when mounting onto the PC boards. Mounting and soldering conditions should be checked beforehand.
Technical considerations	<p>◆Adjustment of mounting machine</p> <ol style="list-style-type: none"> When installing products, care should be taken not to apply distortion stress as it may deform the products. Stress may be applied to a product with a warp or a twist in handling of the product. Please conduct validation completely before studying adoption of this product and please judge the pros and cons of adoption of this product with taking on responsibility. (NRV20/30, NRH24/30, NRS20/30/40/50/60/80, NRM60 Type) <div style="display: flex; justify-content: space-around; align-items: center;"> <div style="text-align: center;"> <p><Wrap></p>  </div> <div style="text-align: center;"> <p><Twist></p>  </div> </div>

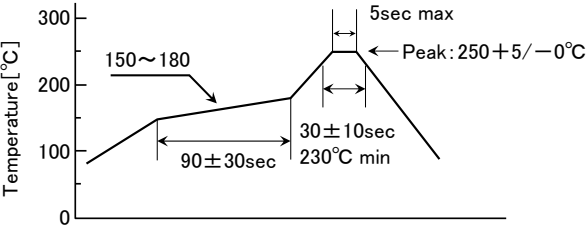
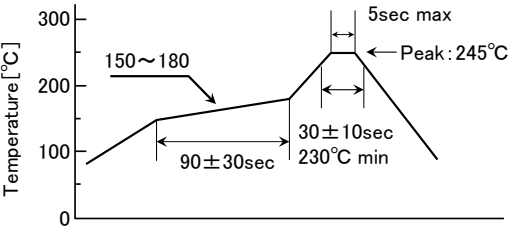
4. Soldering	
Precautions	<p>◆Reflow soldering</p> <ol style="list-style-type: none"> Please contact any of our offices for a reflow soldering, and refer to the recommended condition specified. The product shall be used reflow soldering only. Please do not add any stress to a product until it returns in normal temperature after reflow soldering. <p>◆Lead free soldering</p> <ol style="list-style-type: none"> When using products with lead free soldering, we request to use them after confirming adhesion, temperature of resistance to soldering heat, soldering etc sufficiently. <p>◆Recommended conditions for using a soldering iron</p> <ul style="list-style-type: none"> Put the soldering iron on the land-pattern. Soldering iron's temperature - Below 350°C Duration - 3 seconds or less The soldering iron should not directly touch the inductor.
Technical considerations	<p>◆Reflow soldering</p> <ol style="list-style-type: none"> If products are used beyond the range of the recommended conditions, heat stresses may deform the products, and consequently degrade the reliability of the products. <ul style="list-style-type: none"> NRV20/30, NRH24/30, NRS20/30/40/50/60/80, NRM60 Type, NS101/125 Type, EST0645/1040/1060 Type Recommended reflow condition (Pb free solder) <u>NR, NS Series</u> <div style="display: flex; justify-content: space-around;"> <div style="text-align: center;">  <p>Temperature [°C]</p> <p>Heating Time [sec]</p> </div> <div style="text-align: center;">  <p>Temperature [°C]</p> <p>Heating Time [sec]</p> </div> </div>

5. Cleaning	
Precautions	<p>◆Cleaning conditions</p> <ol style="list-style-type: none"> Washing by supersonic waves shall be avoided.
Technical considerations	<p>◆Cleaning conditions</p> <ol style="list-style-type: none"> If washed by supersonic waves, the products might be broken.

6. Handling

▶ This catalog contains the typical specification only due to the limitation of space. When you consider the purchase of our products, please check our specification. For details of each product (characteristics graph, reliability information, precautions for use, and so on), see our Web site (<http://www.ty-top.com/>)

Precautions	<ul style="list-style-type: none"> ◆ Handling <ol style="list-style-type: none"> 1. Keep the product away from all magnets and magnetic objects. ◆ Breakaway PC boards (splitting along perforations) <ol style="list-style-type: none"> 1. When splitting the PC board after mounting product, care should be taken not to give any stresses of deflection or twisting to the board. 2. Board separation should not be done manually, but by using the appropriate devices. ◆ Mechanical considerations <ol style="list-style-type: none"> 1. Please do not give the product any excessive mechanical shocks. 2. Please do not add any shock and power to a product in transportation. ◆ Pick-up pressure <ol style="list-style-type: none"> 1. Please do not push to add any pressure to a winding part. Please do not give any shock and push into a ferrite core exposure part. ◆ Packing <ol style="list-style-type: none"> 1. Please avoid accumulation of a packing box as much as possible.
Technical considerations	<ul style="list-style-type: none"> ◆ Handling <ol style="list-style-type: none"> 1. There is a case that a characteristic varies with magnetic influence. ◆ Breakaway PC boards (splitting along perforations) <ol style="list-style-type: none"> 1. The position of the product on PCBs shall be carefully considered to minimize the stress caused from splitting of the PCBs. ◆ Mechanical considerations <ol style="list-style-type: none"> 1. There is a case to be damaged by a mechanical shock. 2. There is a case to be broken by the handling in transportation. ◆ Pick-up pressure <ol style="list-style-type: none"> 1. Damage and a characteristic can vary with an excessive shock or stress. ◆ Packing <ol style="list-style-type: none"> 1. If packing boxes are accumulated, that could cause a deformation on packing tapes or a damage on the products.

7. Storage conditions

Precautions	<ul style="list-style-type: none"> ◆ Storage <ol style="list-style-type: none"> 1. To maintain the solderability of terminal electrodes and to keep the packing material in good condition, temperature and humidity in the storage area should be controlled. <ul style="list-style-type: none"> ▪ Recommended conditions <ul style="list-style-type: none"> Ambient temperature : $-5\sim 40^{\circ}\text{C}$ Humidity : Below 70% RH ▪ The ambient temperature must be kept below 30°C. Even under ideal storage conditions, solderability of products electrodes may decrease as time passes. <ul style="list-style-type: none"> For this reason, product should be used within 6 months from the time of delivery. In case of storage over 6 months, solderability shall be checked before actual usage.
Technical considerations	<ul style="list-style-type: none"> ◆ Storage <ol style="list-style-type: none"> 1. Under a high temperature and humidity environment, problems such as reduced solderability caused by oxidation of terminal electrodes and deterioration of taping/packaging materials may take place.

Looking for pricing, stock, or lifecycle information?

Click below to explore more details on WIN SOURCE:

 [View NS10155T220MNV on WIN SOURCE](#)

 [Taiyo Yuden Information](#)

Optimize Your Supply Chain with WIN SOURCE Solutions

-  Global Sourcing Solution
-  Obsolete Management
-  Cost Control Management
-  Shortage Management
-  Alternative Solution
-  Excess Inventory Management