



**THE DATASHEET OF  
LRSA96-15-900**



# LRSA Series

## AC-DC Subrack System



The LRSA product series is a power supply system designed for railway and subway applications. The applicable railway standards, mainly EN 50155, EN 50121-4, and the respective AREMA standards are observed. The power supply system is designed to accommodate special LR converters, such as LR2320-9 or LR2540-9.

A main feature is the enhanced voltage isolation (3000 VAC) between outputs, alarm signals, and the metallic chassis respectively the ground.

The system consists of one rack. The rack can accommodate up to 6 converters, which allows redundant configuration in terms of input and output energy.

A change-over relay contact is available to monitor the function of output voltage. Inhibit function is available to remote on/off.



### FEATURES

- Compliant to AREMA, EN 50155, and EN 50121-4
- RoHS compliant for all 6 substances
- 5 year warranty
- 19-inch rack system, convection cooling
- Extremely rugged, reliable design for harsh environment
- Class I equipment
- Extremely high isolation of all output circuits
- Excellent surge and transient protection
- Wide input voltage range 90 to 264 VAC, 50 to 60 Hz
- Power factor >0.93, harmonics IEC/EN 61000-3-2
- Active output current sharing
- Output voltage monitor with change-over relay contacts
- Inrush current limitation
- Hot swappable
- Inhibit function
- Safety approved to UL/CSA 62368-1 & IEC/EN 62368-1

#### Table of Contents

Page

Page

|                             |   |
|-----------------------------|---|
| Description.....            | 1 |
| Model Selection.....        | 2 |
| Functional Description..... | 6 |
| Electrical Input Data.....  | 7 |
| Electrical Output Data..... | 9 |

|   |    |
|---|----|
| Electromagnetic Compatibility (EMC).....  | 11 |
| Immunity to Environmental Conditions..... | 12 |
| Mechanical Data.....                      | 13 |
| Safety and Installation Instructions..... | 15 |
| Accessories.....                          | 17 |

## MODEL SELECTION

The system consists of LR series AC-DC converters and a 19" shelf.































Table 1: Converters. Other output configurations or special customer adaptations are available on request.

| Output 1              |                     | Output 2              |                     | Operating input range              |                                   | Type designation | Efficiency            |                     |
|-----------------------|---------------------|-----------------------|---------------------|------------------------------------|-----------------------------------|------------------|-----------------------|---------------------|
| $V_{o\ nom}$<br>[VDC] | $I_{o\ nom}$<br>[A] | $V_{o\ nom}$<br>[VDC] | $I_{o\ nom}$<br>[A] | $V_{i\ min} - V_{i\ max}$<br>[VAC] | $f_{i\ min} - f_{i\ max}$<br>[Hz] |                  | $\eta_{min}^1$<br>[%] | $\eta_{typ}$<br>[%] |
| 12                    | 10                  | 12 <sup>2</sup>       | 10                  | 90 – 264                           | 47 – 63                           | LR2320-9         | 90                    | 92                  |
| 15                    | 8                   | 15 <sup>2</sup>       | 8                   | 90 - 264                           | 47 - 63                           | LR2540-9         | 90                    | 92                  |

<sup>1</sup> Min. efficiency at  $V_i = 230\ V$ ,  $I_{o\ nom}$  and  $T_A = 25\ ^\circ C$

<sup>2</sup> Second output semi-regulated

Table 2a: Single output systems (see Fig. 2).

| SINGLE OUTPUT SYSTEMS          |                |       |              |              |   |
|--------------------------------|----------------|-------|--------------|--------------|---|
| Type designation of the system | Output current |       | Output power | Population   | Configuration of the converters in the rack (front view)                              |
|                                | $V_o$          | $I_o$ | $P_o$        |              |   |
| LRSA20-12-900                  | 12 V           | 20 A  | 240 W        | 1 x LR2320-9 |    |
| LRSA40-12-900                  | 12 V           | 40 A  | 480 W        | 2 x LR2320-9 |    |
| LRSA60-12-900                  | 12 V           | 60 A  | 720 W        | 3 x LR2320-9 |    |
| LRSA80-12-900                  | 12 V           | 80 A  | 960 W        | 4 x LR2320-9 |    |
| LRSA100-12-900                 | 12 V           | 100 A | 1200 W       | 5 x LR2320-9 |    |
| LRSA120-12-900                 | 12 V           | 120 A | 1440 W       | 6 x LR2320-9 |   |
| LRSA16-15-900                  | 15 V           | 16 A  | 240 W        | 1 x LR2540-9 |  |
| LRSA32-15-900                  | 15 V           | 32 A  | 480 W        | 2 x LR2540-9 |  |
| LRSA48-15-900                  | 15 V           | 48 A  | 720 W        | 3 x LR2540-9 |  |
| LRSA64-15-900                  | 15 V           | 64 A  | 960 W        | 4 x LR2540-9 |  |
| LRSA80-15-900                  | 15 V           | 80 A  | 1200 W       | 5 x LR2540-9 |  |
| LRSA96-15-900                  | 15 V           | 96 A  | 1440 W       | 6 x LR2540-9 |  |
| LRSA10-24-900                  | 24 V           | 10 A  | 240 W        | 1 x LR2320-9 |  |
| LRSA20-24-900                  | 24 V           | 20 A  | 480 W        | 2 x LR2320-9 |  |
| LRSA30-24-900                  | 24 V           | 30 A  | 720 W        | 3 x LR2320-9 |  |
| LRSA40-24-900                  | 24 V           | 40 A  | 960 W        | 4 x LR2320-9 |  |
| LRSA50-24-900                  | 24 V           | 50 A  | 1200 W       | 5 x LR2320-9 |  |
| LRSA60-24-900                  | 24 V           | 60 A  | 1440 W       | 6 x LR2320-9 |  |
| LRSA08-28-900                  | 28 V           | 8 A   | 224 W        | 1 x LR2540-9 |  |
| LRSA16-28-900                  | 28 V           | 16 A  | 448 W        | 2 x LR2540-9 |  |
| LRSA24-28-900                  | 28 V           | 24 A  | 672 W        | 3 x LR2540-9 |  |
| LRSA32-28-900                  | 28 V           | 32 A  | 896 W        | 4 x LR2540-9 |  |
| LRSA40-28-900                  | 28 V           | 40 A  | 1120 W       | 5 x LR2540-9 |  |
| LRSA48-28-900                  | 28 V           | 48 A  | 1344 W       | 6 x LR2540-9 |  |
| LRSA08-30-900                  | 30 V           | 8 A   | 240 W        | 1 x LR2540-9 |  |
| LRSA16-30-900                  | 30 V           | 16 A  | 480 W        | 2 x LR2540-9 |  |
| LRSA24-30-900                  | 30 V           | 24 A  | 720 W        | 3 x LR2540-9 |  |
| LRSA32-30-900                  | 30 V           | 32 A  | 960 W        | 4 x LR2540-9 |  |
| LRSA40-30-900                  | 30 V           | 40 A  | 1200 W       | 5 x LR2540-9 |  |
| LRSA48-30-900                  | 30 V           | 48 A  | 1440 W       | 6 x LR2540-9 |  |

|               |      |      |        |              |  |  |  |  |  |
|---------------|------|------|--------|--------------|--|--|--|--|--|
| LRSA10-48-900 | 48 V | 10 A | 480 W  | 2 x LR2320-9 |  |  |  |  |  |
| LRSA20-48-900 | 48 V | 20 A | 960 W  | 4 x LR2320-9 |  |  |  |  |  |
| LRSA30-48-900 | 48 V | 30 A | 1440 W | 6 x LR2320-9 |  |  |  |  |  |
| LRSA08-60-900 | 60 V | 8 A  | 480 W  | 2 x LR2540-9 |  |  |  |  |  |
| LRSA16-60-900 | 60 V | 16 A | 960 W  | 4 x LR2540-9 |  |  |  |  |  |
| LRSA24-60-900 | 60 V | 24 A | 1440 W | 6 x LR2540-9 |  |  |  |  |  |

**Note:** Single output system has single input. It is possible to have two independent inputs, but it is necessary to change the part number => LRSAXX-XX-XX1

Table 2b: Double output systems

| DOUBLE OUTPUT SYSTEMS          |                |           |                |           |              |           |              |              |  |
|--------------------------------|----------------|-----------|----------------|-----------|--------------|-----------|--------------|--------------|--|
| Type designation of the system | Output voltage |           | Output current |           | Output power |           | Population   |              | Configuration of the converters in the rack (front view) |
|                                | $V_{O_A}$      | $V_{O_B}$ | $I_{O_A}$      | $I_{O_B}$ | $P_{O_A}$    | $P_{O_B}$ | Section A    | Section B    |  |
| LRSA2020-1212-901              | 12 V           | 12 V      | 20 A           | 20 A      | 240 W        | 240 W     | 1 x LR2320-9 | 1 x LR2320-9 |  |
| LRSA4040-1212-901              | 12 V           | 12 V      | 40 A           | 40 A      | 480 W        | 480 W     | 2 x LR2320-9 | 2 x LR2320-9 |  |
| LRSA6060-1212-901              | 12 V           | 12 V      | 60 A           | 60 A      | 720 W        | 720 W     | 3 x LR2320-9 | 3 x LR2320-9 |  |
| LRSA1616-1515-901              | 15 V           | 15 V      | 16 A           | 16 A      | 240 W        | 240 W     | 1 x LR2540-9 | 1 x LR2540-9 |  |
| LRSA3232-1515-901              | 15 V           | 15 V      | 32 A           | 32 A      | 480 W        | 480 W     | 2 x LR2540-9 | 2 x LR2540-9 |  |
| LRSA4848-1515-901              | 15 V           | 15 V      | 48 A           | 48 A      | 720 W        | 720 W     | 3 x LR2540-9 | 3 x LR2540-9 |  |
| LRSA1010-2424-901              | 24 V           | 24 V      | 10 A           | 10 A      | 240 W        | 240 W     | 1 x LR2320-9 | 1 x LR2320-9 |  |
| LRSA2020-2424-901              | 24 V           | 24 V      | 20 A           | 20 A      | 480 W        | 480 W     | 2 x LR2320-9 | 2 x LR2320-9 |  |
| LRSA3030-2424-901              | 24 V           | 24 V      | 30 A           | 30 A      | 720 W        | 720 W     | 3 x LR2320-9 | 3 x LR2320-9 |  |
| LRSA0808-2828-901              | 28 V           | 28 V      | 8 A            | 8 A       | 224 W        | 224 W     | 1 x LR2540-9 | 1 x LR2540-9 |  |
| LRSA1616-2828-901              | 28 V           | 28 V      | 16 A           | 16 A      | 448 W        | 448 W     | 2 x LR2540-9 | 2 x LR2540-9 |  |
| LRSA2424-2828-901              | 28 V           | 28 V      | 24 A           | 24 A      | 672 W        | 672 W     | 3 x LR2540-9 | 3 x LR2540-9 |  |
| LRSA0808-3030-901              | 30 V           | 30 V      | 8 A            | 8 A       | 240 W        | 240 W     | 1 x LR2540-9 | 1 x LR2540-9 |  |
| LRSA1616-3030-901              | 30 V           | 30 V      | 16 A           | 16 A      | 480 W        | 480 W     | 2 x LR2540-9 | 2 x LR2540-9 |  |
| LRSA2424-3030-901              | 30 V           | 30 V      | 24 A           | 24 A      | 720 W        | 720 W     | 3 x LR2540-9 | 3 x LR2540-9 |  |



**Note:** Each output of system has its own independent input. It is possible to have one input and two outputs, but it is necessary to change the part number => LRSAXXXX-XXXX-XX0

Table 2c: Double output systems - not identical output voltage on sections

| DOUBLE OUTPUT SYSTEMS - NON-IDENTICAL OUTPUT VOLTAGE ON SECTIONS |                  |                  |                  |                  |                  |                  |              |              |  |
|--|------------------|------------------|------------------|------------------|------------------|------------------|--------------|--------------|--|
| Type designation of the system                                   | Output voltage   |                  | Output current   |                  | Output power     |                  | Population   |              | Configuration of the converters in the rack (front view) |
|  | V <sub>O,A</sub> | V <sub>O,B</sub> | I <sub>O,A</sub> | I <sub>O,B</sub> | P <sub>O,A</sub> | P <sub>O,B</sub> | Section A    | Section B    |  |
| LRSA2016-1215-900  | 12 V             | 15 V             | 20 A             | 16 A             | 240 W            | 240 W            | 1 x LR2320-9 | 1 x LR2540-9 |  |
| LRSA4032-1215-900  | 12 V             | 15 V             | 40 A             | 32 A             | 480 W            | 480 W            | 2 x LR2320-9 | 2 x LR2540-9 |  |
| LRSA6048-1215-900  | 12 V             | 15 V             | 60 A             | 48 A             | 720 W            | 720 W            | 3 x LR2320-9 | 3 x LR2540-9 |  |
| LRSA2010-1224-900  | 12 V             | 24 V             | 20 A             | 10 A             | 240 W            | 240 W            | 1 x LR2320-9 | 1 x LR2320-9 |  |
| LRSA4020-1224-900  | 12 V             | 24 V             | 40 A             | 20 A             | 480 W            | 480 W            | 2 x LR2320-9 | 2 x LR2320-9 |  |
| LRSA6030-1224-900  | 12 V             | 24 V             | 60 A             | 30 A             | 720 W            | 720 W            | 3 x LR2320-9 | 3 x LR2320-9 |  |
| LRSA2008-1228-900  | 12 V             | 28 V             | 20 A             | 8 A              | 240 W            | 224 W            | 1 x LR2320-9 | 1 x LR2540-9 |  |
| LRSA4016-1228-900  | 12 V             | 28 V             | 40 A             | 16 A             | 480 W            | 448 W            | 2 x LR2320-9 | 2 x LR2540-9 |  |
| LRSA6024-1228-900  | 12 V             | 28 V             | 60 A             | 24 A             | 720 W            | 672 W            | 3 x LR2320-9 | 3 x LR2540-9 |  |
| LRSA2008-1230-900  | 12 V             | 30 V             | 20 A             | 8 A              | 240 W            | 240 W            | 1 x LR2320-9 | 1 x LR2540-9 |  |
| LRSA4016-1230-900  | 12 V             | 30 V             | 40 A             | 16 A             | 480 W            | 480 W            | 2 x LR2320-9 | 2 x LR2540-9 |  |
| LRSA6024-1230-900  | 12 V             | 30 V             | 60 A             | 24 A             | 720 W            | 720 W            | 3 x LR2320-9 | 3 x LR2540-9 |  |
| LRSA1610-1524-900  | 15 V             | 24 V             | 16 A             | 10 A             | 240 W            | 240 W            | 1 x LR2540-9 | 1 x LR2320-9 |  |
| LRSA3220-1524-900  | 15 V             | 24 V             | 32 A             | 20 A             | 480 W            | 480 W            | 2 x LR2540-9 | 2 x LR2320-9 |  |
| LRSA4830-1524-900  | 15 V             | 24 V             | 48 A             | 30 A             | 720 W            | 720 W            | 3 x LR2540-9 | 3 x LR2320-9 |  |
| LRSA1608-1528-900  | 15 V             | 28 V             | 16 A             | 8 A              | 240 W            | 224 W            | 1 x LR2540-9 | 1 x LR2540-9 |  |
| LRSA3216-1528-900  | 15 V             | 28 V             | 32 A             | 16 A             | 480 W            | 448 W            | 2 x LR2540-9 | 2 x LR2540-9 |  |
| LRSA4824-1528-900  | 15 V             | 28 V             | 48 A             | 24 A             | 720 W            | 672 W            | 3 x LR2540-9 | 3 x LR2540-9 |  |
| LRSA1608-1530-900  | 15 V             | 30 V             | 16 A             | 8 A              | 240 W            | 240 W            | 1 x LR2540-9 | 1 x LR2540-9 |  |
| LRSA3216-1530-900  | 15 V             | 30 V             | 32 A             | 16 A             | 480 W            | 480 W            | 2 x LR2540-9 | 2 x LR2540-9 |  |
| LRSA4824-1530-900  | 15 V             | 30 V             | 48 A             | 24 A             | 720 W            | 720 W            | 3 x LR2540-9 | 3 x LR2540-9 |  |
| LRSA1008-2430-900  | 24 V             | 30 V             | 10 A             | 8 A              | 240 W            | 240 W            | 1 x LR2320-9 | 1 x LR2540-9 |  |
| LRSA2016-2430-900  | 24 V             | 30 V             | 20 A             | 16 A             | 480 W            | 480 W            | 2 x LR2320-9 | 2 x LR2540-9 |  |
| LRSA3024-2430-900  | 24 V             | 30 V             | 30 A             | 24 A             | 720 W            | 720 W            | 3 x LR2320-9 | 3 x LR2540-9 |  |
| LRSA1008-2428-900  | 24 V             | 28 V             | 10 A             | 8 A              | 240 W            | 224 W            | 1 x LR2320-9 | 1 x LR2540-9 |  |
| LRSA2016-2428-900  | 24 V             | 28 V             | 20 A             | 16 A             | 480 W            | 448 W            | 2 x LR2320-9 | 2 x LR2540-9 |  |
| LRSA3024-2428-900  | 24 V             | 28 V             | 30 A             | 24 A             | 720 W            | 672 W            | 3 x LR2320-9 | 3 x LR2540-9 |  |

**Note:** Outputs of system has one common input. It is possible to have two outputs and two independent inputs, but it is necessary to change the part number => LRSAXXXX-XXXX-XX1.  
(Other configurations or special customer adaptations are available on request)

**Note:** Positions without a converter are covered with blank panels.

-  - LR2320-9
-  - LR2540-9
-  - Empty position

**Part Number Description for Single Output System**

LRSA 30-48-9 0 0 Sxxx

Series (product family)..... LRSA  
 Output current..... 08, 10, 16, 20, 24, 30, 32, 40,  
 ..... 48, 50, 60, 64, 80, 96, 100, 120  
 Output voltage ..... 12, 15, 24, 28, 30, 48, 60  
 Operating ambient temperature range  
 $T_A = -40$  to  $+71$  °C ..... -9  
 Options: Bel Power logo on front panel .....0  
 Custom logo on front panel .....5  
 Features: Independent input (no, yes) ..... 0, 1  
 Customer specific model ..... Sxxx<sup>1</sup>

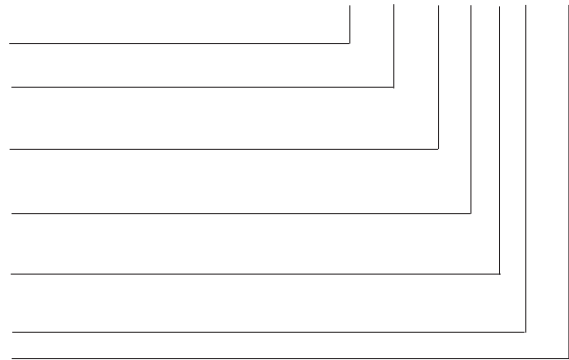

**Part Number Description for Double Output System**

LRSA 2016-1215 - 9 0 0 Sxxx

Series (product family)..... LRSA  
 Output current..... 08, 10, 16, 20, 24, 30, 32, 40, 48, 60  
 Output voltage ..... 12, 15, 24, 28, 30  
 Operating ambient temperature range  
 $T_A = -40$  to  $+71$  °C ..... -9  
 Options: Bel Power logo on front panel .....0  
 Custom logo on front panel .....5  
 Features: Independent input (no, yes) ..... 0, 1  
 Customer specific model ..... Sxxx<sup>1</sup>

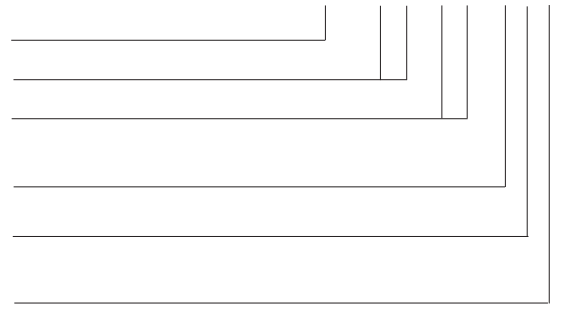

<sup>1</sup> Applicable for non safety critical deviations. xxx are 3 digits assigned for each customer-specific model

**FUNCTIONAL DESCRIPTION**

The input voltage is supplied to up to 6 converters type LR2320-9 / LR2540-9. The outputs of each section of rack are connected in series generating 48 V / 60 V or in parallel generating 12 V, 15 V, 24 V, 30 V. Converters of each section of rack are connected parallel through OR-ing mosfets.

In parallel version of rack (12 V, 15 V, 24 V, 30 V) two sections share their output current evenly due their current share feature. The LR2320-9 converters have two 12 V outputs and the LR2540-9 have two 15 V outputs, which can be connected in parallel or in series. The connection of the outputs is done in the factory by the output voltage selector on the backplane.

The output voltage is monitored in each converter. When the output voltage is in range, a relay with an isolated change-over contact is activated. All relay contacts are connected to the alarm OUT OK connectors.

Inhibit function is available to remote on/off. When the pins of inhibit connector are not connected together, converters will be disabled.

The redundancy of the whole system is depending on the numbers of the converters; see Table 2.

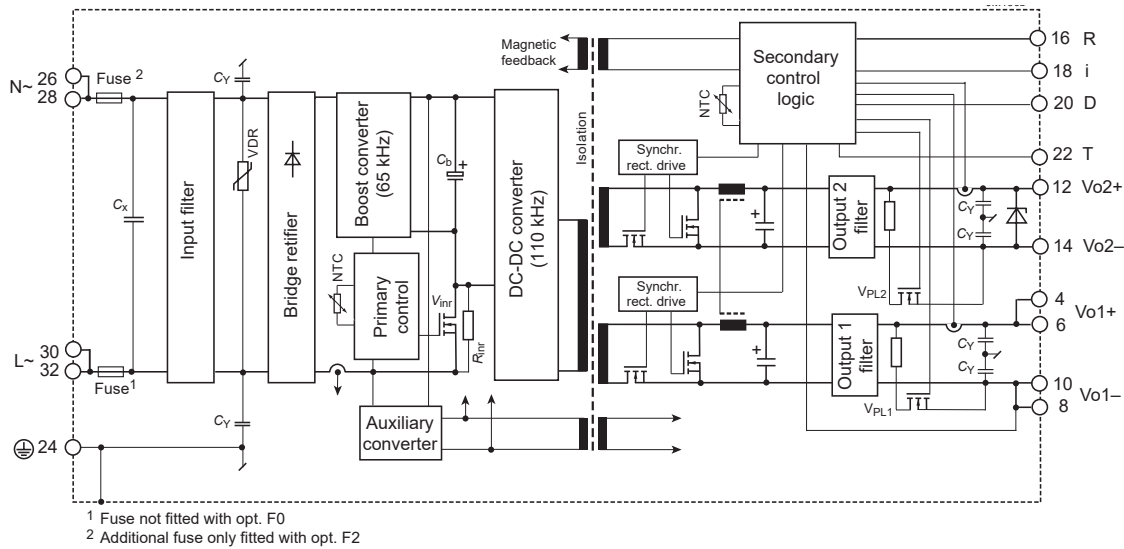

*Fig. 1*  
*Block diagram of a LR series AC-DC converter*

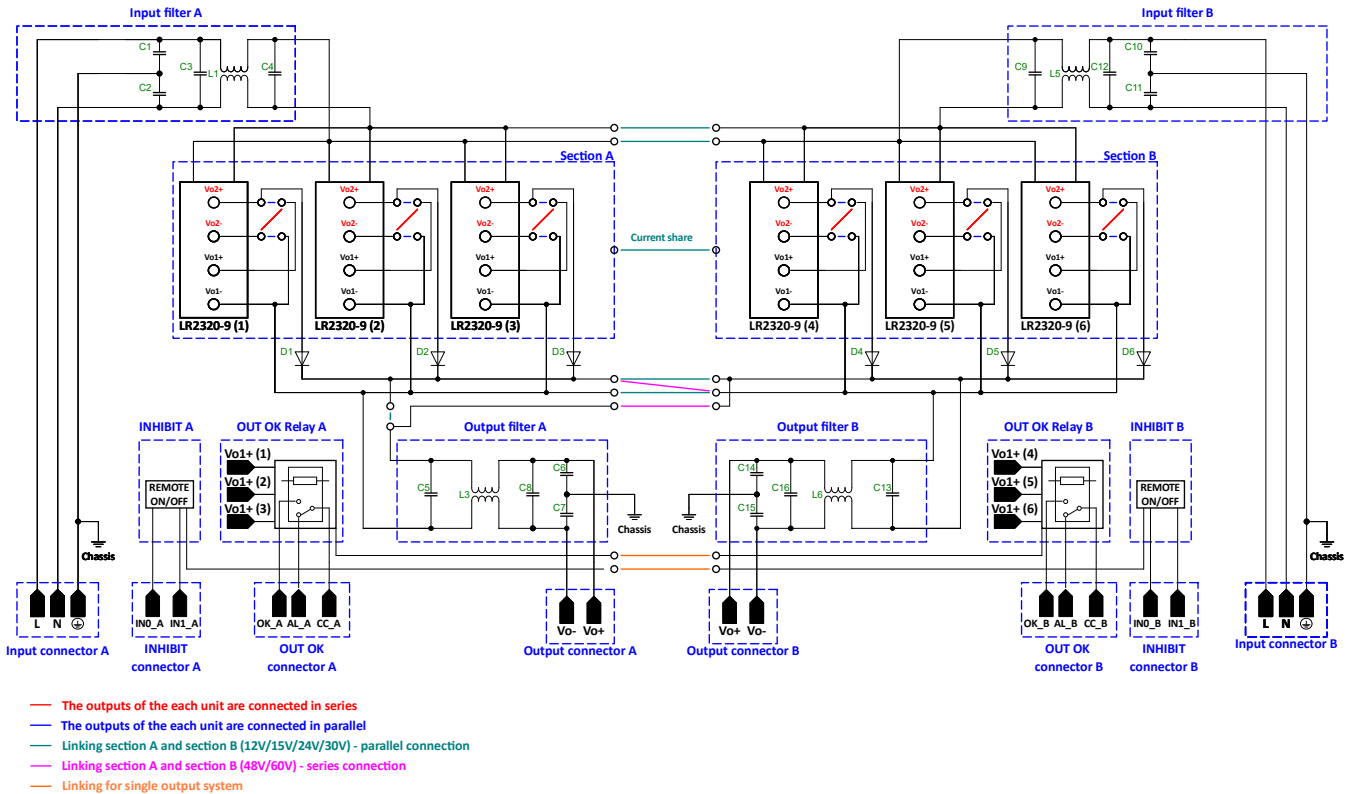

**Fig. 2**  
Block diagram of the rack. The converters in the different positions are fitted depending on the configuration; see table 2. For details of contacts and wires, see Mechanical Data.

## ELECTRICAL INPUT DATA

General Conditions:

- $T_A = 25 \text{ }^\circ\text{C}$ , unless  $T_C$  is specified.
- Pin 18 (i) connected to pin 8, pin 16 (R), pin 18 (D), and pin 22 (T) left open-circuit.

**Table 3: Electrical input data per converter**

| Input             |                                     | Conditions  | LR2320-9  |     |                  | LR2540-9 |     |                  | Unit             |
|-------------------|-------------------------------------|---|-----------|-----|------------------|----------|-----|------------------|------------------|
| Characteristics   |                                     |   | min       | typ | max              | min      | typ | max              |                  |
| $V_i$             | Rated input voltage range           | $I_o = 0 - I_{o\text{nom}}$<br>$T_{C\text{min}}$ to $T_{C\text{max}}$ | 100       |     | 240              | 100      |     | 240              | VAC <sup>1</sup> |
| $V_{i\text{op}}$  | Operating input voltage range       |   | 90        |     | 264              | 90       |     | 264              |                  |
| $V_{i\text{nom}}$ | Nominal input voltage               | 50 – 60 Hz <sup>1</sup>   | 110 / 230 |     | 110 / 230        |          |     |                  |                  |
| $I_i$             | Input current per converter         | $V_i = 230 \text{ V}$ , $I_{o\text{nom}}$ <sup>2</sup>                | 1.2       |     | 1.2              |          |     | A                |                  |
| $P_{i0}$          | No-load input power per converter   | $V_{i\text{min}} - V_{i\text{max}}$ , $I_o = 0$                       |           |     | 15               |          |     | 15               | W                |
| $P_{i\text{inh}}$ | Idle input power                    | Converter inhibited   | 1.3       | 2   | 1.3              |          | 2   |                  |                  |
| $C_b$             | Input capacitance per converter     |   | 360       |     | 360              |          |     | $\mu\text{F}$    |                  |
| $V_{i\text{abs}}$ | Input voltage limits without damage |   | -400      |     | 400 <sup>3</sup> | -400     |     | 400 <sup>3</sup> | VDC <sup>3</sup> |

<sup>1</sup> Rated input frequency: 50 – 60 Hz, operating input frequency: 47 – 63 Hz.

<sup>2</sup> Outputs loaded with  $I_{o\text{nom}}$

<sup>3</sup> For  $\leq 1 \text{ s}$ .

### Input Fuse and Protection of the Converters

A VDR together with the input fuse and a symmetrical input filter form an effective protection against high input transient voltages. Input fuse: slow-blow, 6.3 A, 250 V, slow, 5 × 20 mm.

This applies only for modules/converters. The backplane has no additional protection (fuse, VDR).

### Input Under-/Overvoltage Lockout

If the input voltage remains below approx. 80 VAC or exceeds  $V_{i\ op\ max}$ , an internally generated inhibit signal disables the outputs. Do not check the overvoltage lockout function!

If  $V_i$  is below  $V_{i\ min}$ , but above the undervoltage lockout level, the output voltage may be below the value specified in the tables *Electrical Output Data*.

### Efficiency

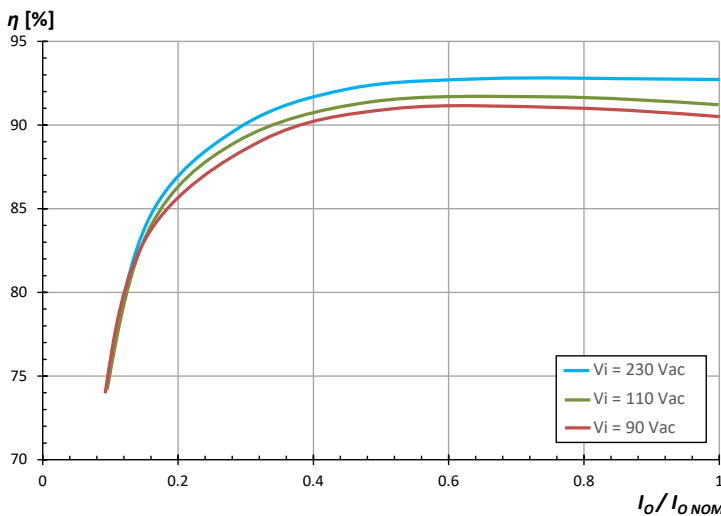

Fig. 3 Efficiency versus  $V_i$  and  $I_o$  (LRP2320 / LRP2540, both outputs connected in series)

### Power Factor and Harmonics

Power factor correction is achieved by controlling the input current waveform synchronously with the input voltage waveform. The power factor control is active under all operating conditions.

Harmonic distortions are below the limits specified in IEC/EN 61000-3-2, class A.

### Hold-up time

The integrated storage capacitor ( $C_b$ ) is loaded to the boost voltage and ensures full output voltage with nominal load during the specified interruption time of 20 ms.

### Inrush Current Limitation

The converters exhibit an electronic circuit to limit the inrush current at switch-on.

## ELECTRICAL OUTPUT DATA

Table 4a: Output data of the converter connected in series

| Model             |   |  | LR2320-9   |       |      | LR2540-9               |                      |      | Unit |
|-------------------|---|--|------------|-------|------|------------------------|----------------------|------|------|
| Characteristics   |   |  | Conditions |       |      | Output 1 + 2 in series |                      |      |      |
|                   |   |  | min        | typ   | max  | min                    | typ                  | max  |      |
| $V_o$             | Output voltage                                      | $V_{i\ nom}, I_{o\ nom}$                           |            | 24    |      |                        | 30 (28) <sup>1</sup> |      | V    |
| $I_{o\ nom}$      | Output current nom.                                 | $V_{i\ min} - V_{i\ max}, T_{C\ min} - T_{C\ max}$ |            | 10    |      |                        | 8                    |      | A    |
| $I_{oL}$          | Output current limit                                | $V_{i\ min} - V_{i\ max}$                          | 10.5       |       |      | 8.4                    |                      |      |      |
| $\Delta V_{o\ u}$ | Static line regulation with respect to $V_{i\ nom}$ | $V_{i\ min} - V_{i\ max}, I_{o\ nom}$              |            |       | ±120 |                        |                      | ±150 | mV   |
| $\Delta V_{o\ l}$ | Static load regulation <sup>1</sup>                 | $V_{i\ nom}, (0.1 - 1) I_{o\ nom}$                 |            |       | ±120 |                        |                      | ±150 |      |
| $\alpha_{vo}$     | Temperature coefficient of output voltage           | $T_{C\ min} - T_{C\ max}, I_{o\ nom}$              |            | ±0.02 |      |                        | ±0.02                |      | %/K  |

<sup>1</sup> Output voltage is adjusted on the backplane of the rack

Table 4b: Output data of the converter connected in parallel

| Model             |   |  | LR2320-9   |       |      | LR2540-9                 |       |      | Unit |
|-------------------|---|--|------------|-------|------|--------------------------|-------|------|------|
| Characteristics   |   |  | Conditions |       |      | Output 1 + 2 in parallel |       |      |      |
|                   |   |  | min        | typ   | max  | min                      | typ   | max  |      |
| $V_o$             | Output voltage                                      | $V_{i\ nom}, I_{o\ nom}$                           |            | 12    |      |                          | 15    |      | V    |
| $I_{o\ nom}$      | Output current nom.                                 | $V_{i\ min} - V_{i\ max}, T_{C\ min} - T_{C\ max}$ |            | 20    |      |                          | 16    |      | A    |
| $I_{oL}$          | Output current limit                                | $V_{i\ min} - V_{i\ max}$                          | 21         |       |      | 16.8                     |       |      |      |
| $\Delta V_{o\ u}$ | Static line regulation with respect to $V_{i\ nom}$ | $V_{i\ min} - V_{i\ max}, I_{o\ nom}$              |            |       | ±120 |                          |       | ±150 | mV   |
| $\Delta V_{o\ l}$ | Static load regulation <sup>1</sup>                 | $V_{i\ nom}, (0.1 - 1) I_{o\ nom}$                 |            |       | ±120 |                          |       | ±150 |      |
| $\alpha_{vo}$     | Temperature coefficient of output voltage           | $T_{C\ min} - T_{C\ max}, I_{o\ nom}$              |            | ±0.02 |      |                          | ±0.02 |      | %/K  |

### Thermal Considerations

If a converter is located in free, quasi-stationary air (convection cooling) at the indicated maximum ambient temperature  $T_{A\ max}$  (see table *Temperature specifications*) and is operated within the specified input voltage range with nominal load, the temperature measured at the *Measuring point of case temperature*  $T_C$  (see *Mechanical Data*) will approach the indicated value  $T_{C\ max}$  after the warm-up phase. However, the relationship between  $T_A$  and  $T_C$  depends heavily upon the conditions of operation and integration into a system. The thermal conditions are influenced by input voltage, output current, airflow, and temperature of surrounding components and surfaces.  $T_{A\ max}$  is therefore, contrary to  $T_{C\ max}$ , an indicative value only.

**Caution:** The installer must ensure that under all operating conditions  $T_C$  remains within the limits stated in the table *Temperature specifications*. If  $T_{C\ max}$  is exceeded during operating conditions, an adequate forced cooling of system may be required to sustain  $T_{C\ max}$  is within allowed limits.

### Thermal Protection of the Converters

Two temperature sensors generate an internal inhibit signal, which disables the converter in case of overtemperature. The outputs automatically recover when the temperature drops below the limit.

Continuous operation under simultaneous extreme worst-case conditions of the following three parameters should be avoided: Minimum input voltage, maximum output power, and maximum temperature.

### Output Protection of the Converters

The 2<sup>nd</sup> output is protected by a suppressor diode against overvoltage, which could occur due to a failure of the internal control circuit. This suppressor diode was not designed to withstand externally applied overvoltages. Overload at any of the outputs will cause both outputs to shut-down.

**Note:** The output voltage of the first output is monitored. If it exceeds typ. 140% of  $V_{o\ nom}$  for 10 ms, the converter is inhibited by a latch. To reactivate,  $V_i$  must be removed or the converter disabled through an inhibit signal to pin 18.

Each output has its own current limiting circuit, providing a rectangular output characteristic and protecting against short circuit. There is no limitation for the capacitive load.

The 12 V and 15 V LRSA Rack models have different behavior in short circuit compared to other models. When short circuit occurs, unit will not shutdown for 30 seconds. If the short circuit persists, converter's output will be cycled – 1 second ON and 5 seconds OFF. If the short circuit disappears, converter output returns to  $V_{o\ nom}$ .

### Output Voltage Regulation of the Converters

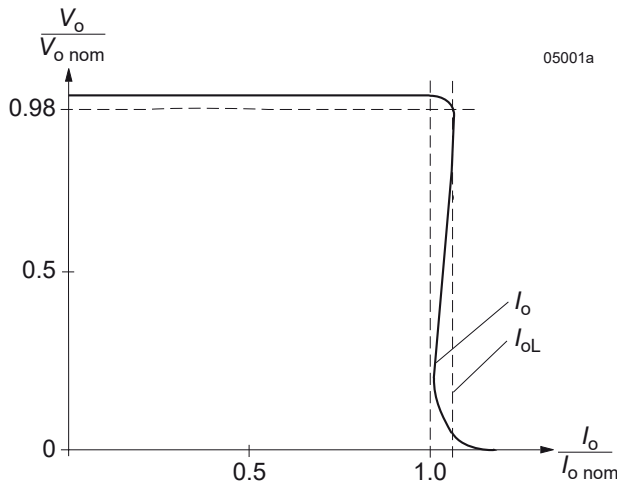

Fig. 4. Typical output characteristic  $V_o$  versus  $I_o$ .

### Inhibit for Remote On/Off

The outputs of units in section A and section B, may be enabled or disabled by inhibit function. If pins of inhibit connector are connected together, the outputs are enabled. If these pins are not connected together, the outputs are disabled.

In the case of single output system, only one inhibit connector is fitted (pins IN0\_B, IN1\_B).

In case of double output system, both inhibit connectors are fitted (pins IN0\_A, IN1\_A and IN0\_B, IN1\_B). The section A and section B have their own inhibit connector.

The inhibit disables the DC-DC converters immediately, without respecting the hold-up time. The input section of the converter is not disabled.

### Output Voltage Monitor of the Converters

The output voltage monitor generates a logic “low” signal (NPN open-collector output) at the D-output (pin 20), when  $V_o1 \geq 0.96 V_{o\ nom}$  and  $\leq 1.04 V_{o\ nom}$  (typ. values).

When the output is in range, a relay with a change-over contact located on the backplane is connecting CC with OK. When the output is out of range, a relay is connecting CC with AL.

In case of single output system, only one relay and one OUT OK connector are fitted on the backplane.

In case of double output system, section A and section B have their own relay and OUT OK connector.

### LED Indicators

Two green indicators are visible at the front plate:

- Out OK; see *Output Voltage Monitor*
- In OK. This signal is activated, when  $V_i$  is in range and the converter is not disabled by the inhibit signal.

## ELECTROMAGNETIC COMPATIBILITY (EMC)

The **converters** and populated **subrack systems** successfully been tested to the following specifications:

### Immunity

Table 5: Electromagnetic immunity (type tests). Corresponds or Exceeds EN50121-3-2:2016 and AREMA

| Phenomenon                         | Standard         | Level | Coupling mode <sup>1</sup> | Value applied           | Waveform  | Source imped.           | Test procedure  | In oper. | Perf. crit. <sup>2</sup> |
|------------------------------------|------------------|-------|----------------------------|-------------------------|---|-------------------------|---|----------|--------------------------|
| Electrostatic discharge (to case)  | IEC/EN 61000-4-2 | 4     | contact discharge          | $\pm 6000 V_p$          | 1/50 ns   | 330 $\Omega$<br>150 pF  | 10 pos. & 10 neg. discharges                                | yes      | A                        |
|                                    |                  |       | air discharge              | $\pm 8000 V_p$          |   |                         |   |          |                          |
| Electromagnetic field              | IEC/EN 61000-4-3 | x     | antenna                    | 20 V/m                  | AM 80% / 1 kHz  | N/A                     | 80 – 800 MHz  | yes      | A                        |
|                                    |                  |       | antenna                    | 20 V/m                  |   |                         | 1400 – 2000 MHz   |          |                          |
|                                    |                  |       |                            | 5 V/m                   |   |                         | 2000 – 2700 MHz   |          |                          |
|                                    |                  |       |                            | 3 V/m                   |   |                         | 5100 – 6000 MHz   |          |                          |
| Electrical fast transients / burst | IEC/EN 61000-4-4 | 3     | capacitive, o/c            | $\pm 2000 V_p$          | bursts of 5/50 ns;<br>2.5 / 5 kHz over 15 ms;<br>burst period: 300 ms | 50 $\Omega$             | 60 s positive<br>60 s negative transients per coupling mode | yes      | A                        |
|                                    |                  | 4     | $\pm i/c, +i/-i$ direct    | $\pm 4000 V_p$          |   |                         |   |          |                          |
| Surges                             | IEC/EN 61000-4-5 | 3     | i/c                        | $\pm 2000 V_p$          | 1.2 / 50 $\mu s$  | 12 $\Omega$ / 9 $\mu F$ | 5 pos. & 5 neg. surges per coupling mode                    | yes      | A                        |
|                                    |                  |       | i/c, +i/-i                 | $\pm 2000 V_p$          |   | 2 $\Omega$ / 18 $\mu F$ |   |          | B                        |
|                                    |                  |       | +i/-i                      | $\pm 1000 V_p$          |   | 2 $\Omega$ / 18 $\mu F$ |   |          | A                        |
| Conducted disturbances             | IEC/EN 61000-4-6 | 3     | i, o, signal wires         | 10 VAC (140 dB $\mu$ V) | AM 80% / 1 kHz  | 150 $\Omega$            | 0.15 – 80 MHz   | yes      | A                        |
| Power frequency magnetic field     | IEC/EN 61000-4-8 | 3     | -                          | 300 A/m                 | 0 to 50 Hz  |                         | 60 s in all 3 axes  | yes      | A                        |

<sup>1</sup> i = input, o = output, c = case

<sup>2</sup> A = normal operation, no deviation from specs.; B = normal operation, temporary loss of function or deviation from specs possible

### Emissions

All models comply with Class A according to EN 55011/55032 for conducted and radiated emissions.

## IMMUNITY TO ENVIRONMENTAL CONDITIONS

The populated subrack system has been tested as per table 6.

Table 6: Mechanical and climatic stress

| Test method |  | Standard   | Test Conditions                |   | Operating Condition     |
|-------------|--|--|--------------------------------|---|-------------------------|
| Cab         | Damp heat steady state   | IEC/EN 60068-2-78<br>MIL-STD-810D section 507.2  | Temperature:                   | 40 <sup>±2</sup> °C   | Converter not operating |
|             |  |  | Relative humidity:             | 93 <sup>+2/-3</sup> %   |                         |
|             |  |  | Duration:                      | 56 days   |                         |
| Db          | Cyclic damp heat test  | EN 50155:2021, clause 13.4.8<br>IEC/EN 60068-2-30  | Temperature:                   | 55 °C and 25 °C   | Converter not operating |
|             |  |  | Cycles (respiration effect)    | 2   |                         |
|             |  |  | Duration:                      | 2x 24 h   |                         |
| Be          | Dry heat test steady state                                       | EN 50155:2021, clause 13.4.5<br>IEC/EN 60068-2-2   | Temperature:                   | 70 °C   | Converter operating     |
|             |  |  | Duration:                      | 6 h   |                         |
| Ad          | Low temperature start-up test                                    | EN 50155:2021, clause 13.4.4<br>IEC/EN 60068-2-1   | Temperature, duration:         | -40 °C, 2 h   | Converter not operating |
|             |  |  | Performance test:              | +25 °C  |                         |
| Ka          | Salt mist test sodium chloride (NaCl) solution                   | EN 50155:2021, clause 13.4.13<br>IEC/EN 60068-2-11 class ST2                                     | Temperature:                   | 35 <sup>±2</sup> °C   | Converter not operating |
|             |  |  | Duration:                      | 48 h  |                         |
| Fh          | Random vibration broad band (digital control) & guidance         | IEC/EN 60068-2-64  | Acceleration spectral density: | 0.05 g <sub>n</sub> <sup>2</sup> /Hz  | Converter operating     |
|             |  |  | Frequency band:                | 8 – 500 Hz  |                         |
|             |  |  | Acceleration magnitude:        | 4.9 g <sub>n,rms</sub>  |                         |
|             |  |  | Test duration:                 | 1.5 h (0.5 h in each axis)  |                         |
| Fc          | Vibration (sinusoidal)   | IEC/EN 60068-2-6<br>MIL-STD-810D section 514.3   | Acceleration amplitude:        | 0.35 mm (10 – 60 Hz)<br>5 g <sub>n</sub> = 49 m/s <sup>2</sup> (60 - 2000 Hz) | Converter operating     |
|             |  |  | Frequency (1 Oct/min):         | 10 – 2000 Hz  |                         |
|             |  |  | Test duration:                 | 7.5 h (2.5 h in each axis)  |                         |
| -           | Vibration  | AREMA Part. 11.5.1 class B, C, D, E, I, J  | Displacement amplitude:        | 0.3" (5 – 10 Hz)<br>0.1" (5 – 20 Hz)  | Converter operating     |
|             |  |  | Acceleration amplitude:        | 2 g <sub>n</sub> = 19.6 m/s <sup>2</sup> (10 - 200 Hz)                        |                         |
|             |  |  | Frequency (1 Oct/min):         | 5 – 200 Hz  |                         |
|             |  |  | Test duration:                 | 12 h (4 h in each axis)   |                         |
| Ea          | Shock (half-sinusoidal)  | IEC/EN 60068-2-27<br>MIL-STD-810D section 516.3  | Acceleration amplitude:        | 50 g <sub>n</sub> = 490 m/s <sup>2</sup>                                      | Converter operating     |
|             |  |  | Bump duration:                 | 11 ms   |                         |
|             |  |  | Number of bumps:               | 18 (3 in each direction)  |                         |
| -           | Shock  | EN 50155:2021 clause 13.4.10,<br>EN 61373 sect. 10,<br>class B, body mounted <sup>1</sup>        | Acceleration amplitude:        | 5.1 g <sub>n</sub>  | Converter operating     |
|             |  |  | Bump duration:                 | 30 ms   |                         |
|             |  |  | Number of bumps:               | 18 (3 in each direction)  |                         |
| -           | Mechanical shock   | AREMA Part. 11.5.1 class B, C, D, E, I, J  | Acceleration amplitude:        | 10 g <sub>n</sub> = 98 m/s <sup>2</sup>                                       | Converter operating     |
|             |  |  | Bump duration:                 | 11 ms   |                         |
|             |  |  | Number of bumps:               | 18 (3 in each direction)  |                         |
| -           | Simulated long life testing at increased random vibration levels | EN 50155:2021 clause 13.4.10.2,<br>EN 61373 sect. 8 and 9,<br>class B, body mounted <sup>1</sup> | Acceleration spectral density: | 0.01 g <sub>n</sub> <sup>2</sup> /Hz  | Converter operating     |
|             |  |  | Frequency band:                | 5 – 150 Hz  |                         |
|             |  |  | Acceleration magnitude:        | 0.57 g <sub>n,rms</sub>   |                         |
|             |  |  | Test duration:                 | 15 h (5 h in each axis)   |                         |

<sup>1</sup> Body mounted = chassis of a railway coach

**Temperatures**

Table 7: Temperature specifications, valid for an air pressure of 800 – 1200 hPa (800 – 1200 mbar)

| Model | Characteristics     | Conditions          | -9 min | -9 typ | max               | Unit |
|-------|---------------------|---------------------|--------|--------|-------------------|------|
| $T_A$ | Ambient temperature | Converter operating | - 40   |        | 45 <sup>1,2</sup> | °C   |
|       |                     |                     | - 40   |        | 71 <sup>1,3</sup> |      |
| $T_C$ | Case temperature    |                     | - 40   |        | 95 <sup>1,4</sup> |      |
| $T_S$ | Storage temperature | Not operating       | - 55   |        | 85                |      |

- <sup>1</sup> See *Thermal Considerations*.
- <sup>2</sup> Natural convection cooling.
- <sup>3</sup> 400 LFM forced air cooling.
- <sup>4</sup> Overtemperature lockout at  $T_C > 95$  °C. (An NTC resistor on primary and secondary heatsink of converter.)

**MECHANICAL DATA**

Dimensions in mm. The converters are designed to be inserted into a 19" rack, 160 mm long, according to IEC 60297-3.

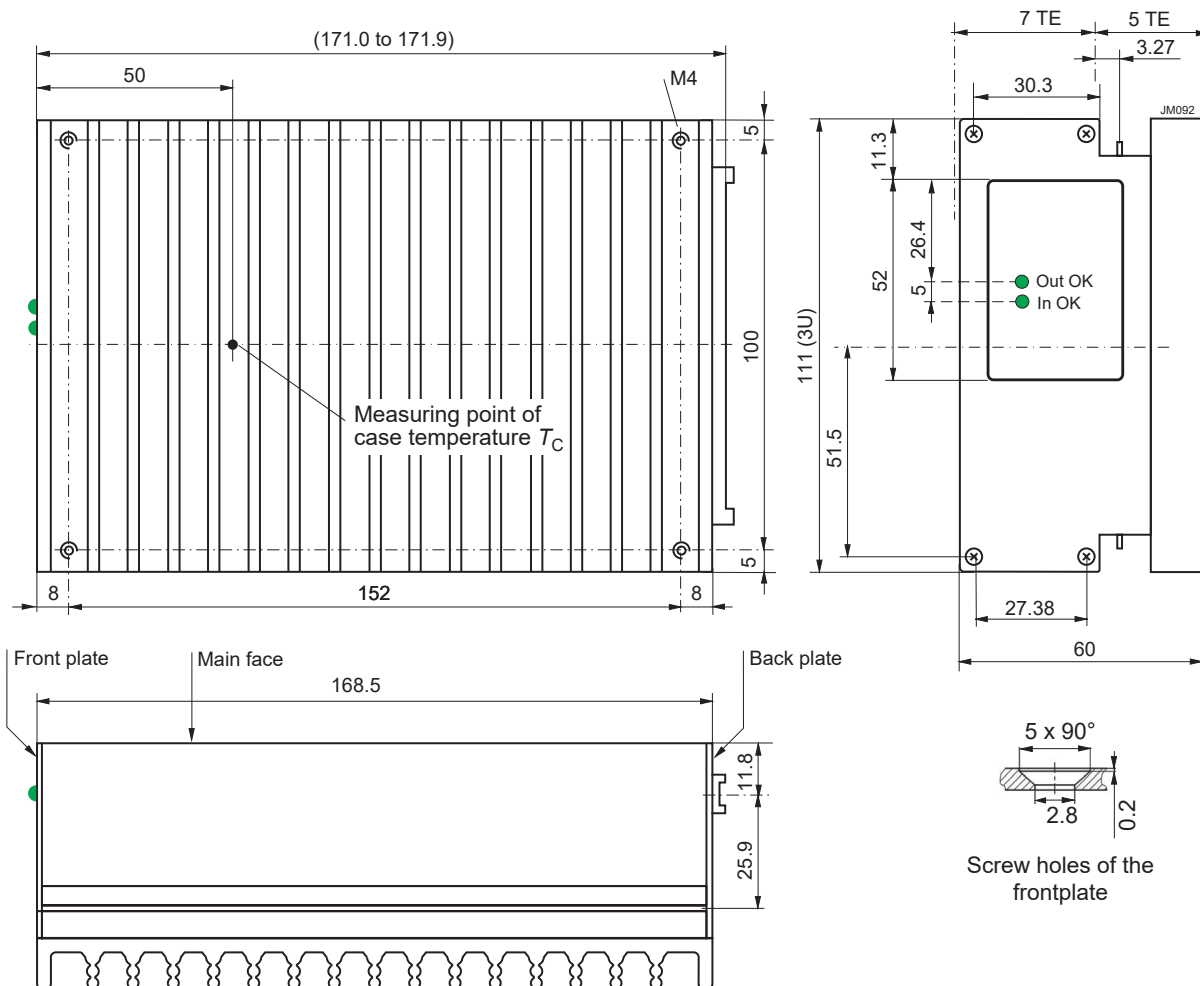
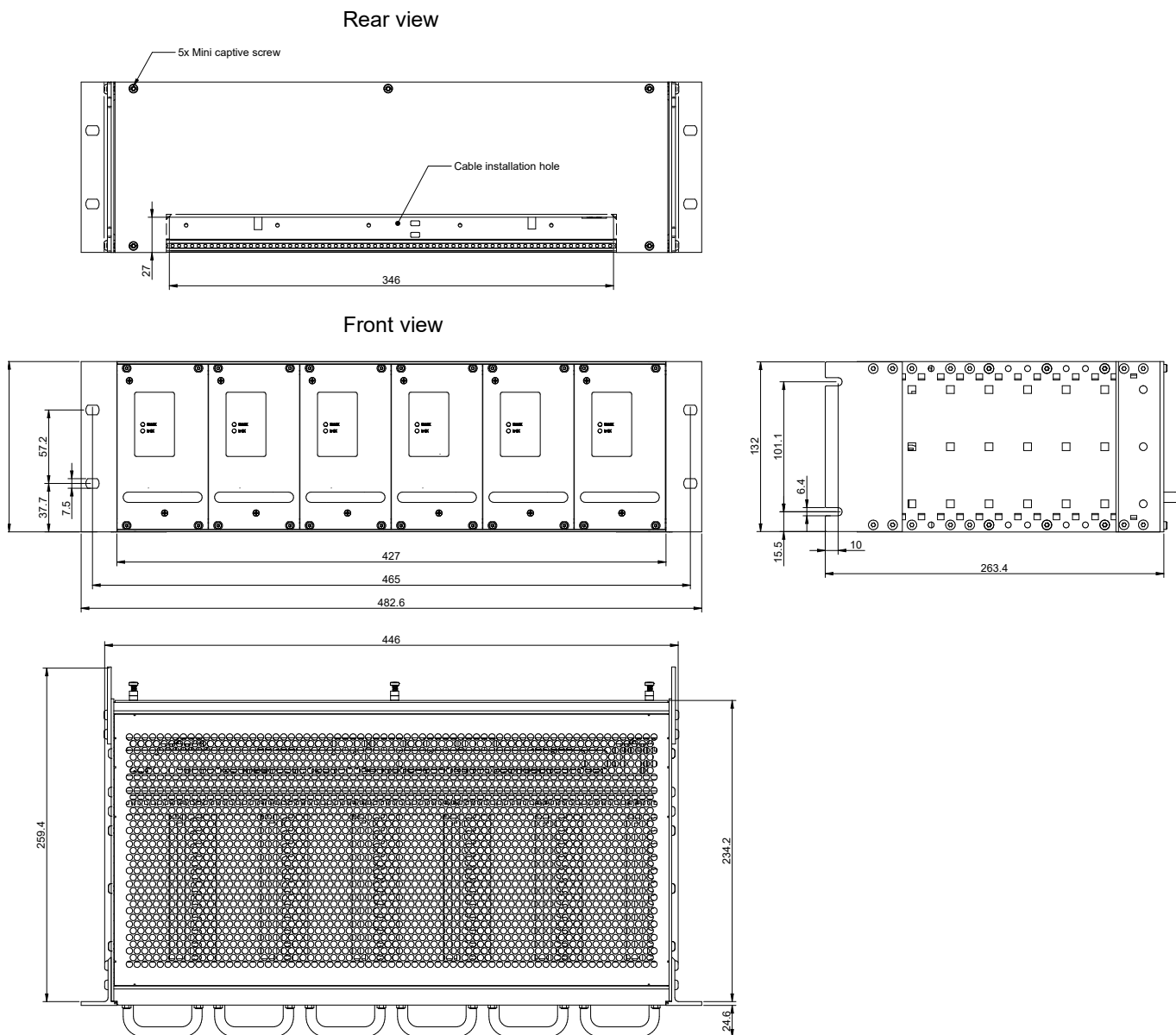

Fig. 5  
Aluminum case of LR models with heat sink; black finish (EP powder coated); weight approx. 1.5 kg



**Fig. 6**  
19" fully assembled rack LRSA30-48-900, dimensions in mm. Weight approx. 2.8 kg (empty rack MK007-500 without converters)

## SAFETY AND INSTALLATION INSTRUCTIONS

Please read the Installation Instruction (BCM.20067).

Table 8: Input/output and signal connector pinning

| Position               |      | Manufacturer / MPN | # of pins | Min / Max wire cross section <sup>1</sup> |
|------------------------|------|--------------------|-----------|---|
| Input A<br>Input B     | L    | WAGO / 745-1403    | 3         | 14 / 10 AWG                               |
|                        | N    |                    |           | 14 / 10 AWG                               |
|                        | ⊕    |                    |           | 14 / 10 AWG                               |
| Output A<br>Output B   | +Vo  | WAGO / 745-602     | 2         | 16 / 6 AWG                                |
|                        | - Vo | WAGO / 745-602     | 2         | 16 / 6 AWG                                |
| OUT OK A<br>OUT OK B   |      | WAGO / 745-103     | 3         | 28 / 12 AWG                               |
| Inhibit A<br>Inhibit B |      | WAGO / 745-102     | 2         | 28 / 12 AWG                               |

<sup>1</sup> This is min./max. wire cross section fitting to the connector, the used wire cross section depends on maximum output current.

### Connector Pin Allocation of the LRSA rack system

Table 9: Input pins allocation

#### INPUT A, B

| Pin No. | Name | Current rating per pin | Max size of interconnecting wire | Wire rating       | Function                     |
|---------|------|------------------------|----------------------------------|-------------------|------------------------------|
| 1       | L~   | 30 A                   | 10 AWG / 6 mm <sup>2</sup>       | > 300 Vrms, 105°C | Phase line                   |
| 2       | N~   | 30 A                   | 10 AWG / 6 mm <sup>2</sup>       | > 300 Vrms, 105°C | Neutral line                 |
| 3       | ⊕    | 30 A                   | 10 AWG / 6 mm <sup>2</sup>       | > 300 Vrms, 105°C | Protection earth PE and case |

Table 10: Output pins allocation

#### OUTPUT A, B

| Pin No. | Name | Current rating per pin | Max size of interconnecting wire | Function        |
|---------|------|------------------------|----------------------------------|-----------------|
| 1       | Vo-  | 65 A                   | 6 AWG / 16 mm <sup>2</sup>       | Negative Output |
| 2       | Vo-  | 65 A                   | 6 AWG / 16 mm <sup>2</sup>       | Negative Output |
| 3       | Vo+  | 65 A                   | 6 AWG / 16 mm <sup>2</sup>       | Positive Output |
| 4       | Vo+  | 65 A                   | 6 AWG / 16 mm <sup>2</sup>       | Positive Output |

Table 11: OUT OK A, B pins allocation

#### OUT OK A, B

| Pin No. | Name | Current rating per pin | Max size of interconnecting wire | Function                    |
|---------|------|------------------------|----------------------------------|-----------------------------|
| 1       | AL   | 10 A                   | 12 AWG / 4 mm <sup>2</sup>       | Rest contact                |
| 2       | CC   | 10 A                   | 12 AWG / 4 mm <sup>2</sup>       | Change contact              |
| 3       | OK   | 10 A                   | 12 AWG / 4 mm <sup>2</sup>       | Operating contact (Vo okay) |

Table 12: INHIBIT A, B pins allocation

#### INHIBIT A, B

| Pin No. | Name | Current rating per pin | Max size of interconnecting wire | Function         |
|---------|------|------------------------|----------------------------------|------------------|
| 1       | IN1  | 10 A                   | 12 AWG / 4 mm <sup>2</sup>       | Inhibit positive |
| 2       | IN0  | 10 A                   | 12 AWG / 4 mm <sup>2</sup>       | Inhibit negative |

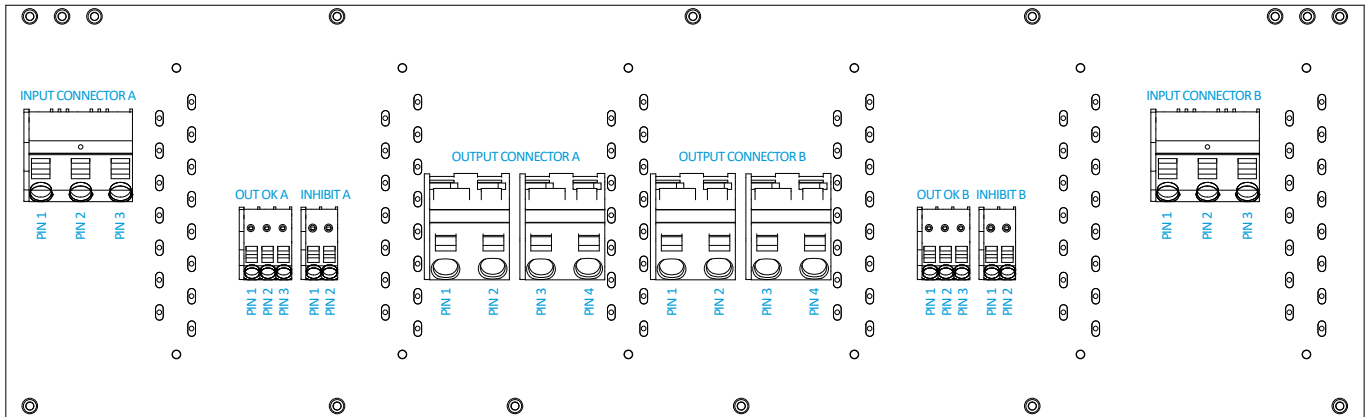

Fig. 7

Layout of the connectors on the backplane

Note: This layout is for dual output systems. For single output systems, only section B connectors are placed.

### Standards and Approvals

The LRSA series subrack system is approved according to IEC/EN 62368-1. The converters are safety-approved to UL/CSA 62368-1 and IEC/EN 62368-1.

The converters correspond to Class I equipment (case connected to ground). They have been evaluated for:

- Building-in
- Basic insulation between input and case based on 250 VA; basic insulation between outputs and case; double or reinforced insulation between input and outputs
- Functional insulation between outputs
- Overvoltage category II
- Pollution degree 2 environment
- Max. altitude: 2000 m
- IP40 (from the front side)
- The converters fulfil the requirements of a fire enclosure

The output voltage is considered as ES1. The converters are subject to manufacturing surveillance in accordance with the above mentioned safety standards and with ISO 9001:2015, IRIS ISO/TS 22163:2017 certified quality and business management system. CB-scheme is available on request.

### Touch Currents per Converter

Touch currents flow due to internal leakage capacitances and Y-caps. The current values are proportional to the voltage and frequency of the supply. They are specified in the Table 13.

Table 13: Touch currents per converter

| Characteristics       |   | Class I | Unit |
|-----------------------|---|---------|------|
| Maximum touch current | Permissible according to IEC/EN 62368-1   | 5.0     | mA   |
|                       | Typ. value at 264 V, 50 Hz; per converter | 1.0     |      |

### Protective Lacquer

All boards of the converters are coated with a protective lacquer. The rack including the back plane is designed with higher creepage distances and clearances, but is not protected by lacquer.

### Isolation and Protective Earth

The electric strength test is performed in the factory as routine test according to EN 62911 and IEC/EN 62368-1 and should not be repeated in the field. The company will not honor any warranty claims resulting from incorrectly executed electric strength field tests. The resistance between case and earth pin ( $<0.1 \Omega$ ) is tested as well.

Table 14: Isolation

| Characteristics                  |  | Input to Case + Output(s) | Output(s) to Case and Input | Output 1 to Output 2 | Unit |
|----------------------------------|--|---------------------------|-----------------------------|----------------------|------|
| Electric strength test           | Factory test 10 s                          | 2.84 <sup>1</sup>         | 4.3                         | 0.5                  | kVDC |
|                                  | AC test voltage equivalent to factory test | 2.0 <sup>1</sup>          | 3.0                         | 0.3                  | kVAC |
| Insulation resistance at 500 VDC |  | >300                      | >300                        | >300                 | MΩ   |
| Creepage distances               |  | ≥ 3.5 <sup>2</sup>        | ≥ 4.5                       | ---                  | mm   |

<sup>1</sup> Subassemblies connecting input to output are pre-tested with 5.6 kVDC or 4 kVAC.

<sup>2</sup> Input to outputs: 7.0 mm

Protective earthing of the LRSA subrack system is provided by inserting wire to the Input connector (pin 3) and additionally wire mounted to grounding screw – see Fig. 8 below. Each wire used for grounding must have minimal cross section 2.5 mm<sup>2</sup> (14 AWG).

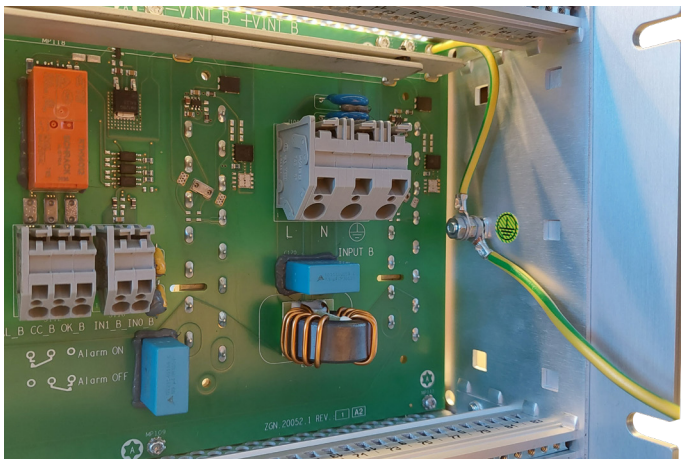

Fig. 8  
Protective earthing of LRSA subrack system

## ACCESSORIES

Blank Panel / Filler: HZZ02018G

Single modules LR2320-9: YPA.20372.0 / LR2540-9: YPA.20373.0



Fig. 9  
Blank Panel HZZ02018G



Fig. 10  
Single module LR2320-9 (YPA.20372.0) / LR2540-9 (YPA.20373.0)

**NUCLEAR AND MEDICAL APPLICATIONS** - These products are not designed or intended for use as critical components in life support systems, equipment used in hazardous environments, or nuclear control systems.

**TECHNICAL REVISIONS** - The appearance of products, including safety agency certifications pictured on labels, may change depending on the date manufactured. Specifications are subject to change without notice.

## Looking for pricing, stock, or lifecycle information?

Click below to explore more details on WIN SOURCE:

- [View LRSA96-15-900 on WIN SOURCE](#)
- [Bel Power Solutions Information](#)

## Optimize Your Supply Chain with WIN SOURCE Solutions

- ✓ Global Sourcing Solution
- ✓ Obsolete Management
- ✓ Cost Control Management
- ✓ Shortage Management
- ✓ Alternative Solution
- ✓ Excess Inventory Management