



**THE DATASHEET OF
40-9709HM**





DESCRIPTION:
 PART NUMBER:
 APPLICATION:
 CRIMP TOOL:
 IMPEDANCE:
 FREQUENCY RANGE:
 MATERIAL:
 RoHS COMPLIANCE:
 TECHNICAL DETAIL:
 ATTACHMENT:

D-SUB HOOD, SHIELD
 40-9709HM
 D-SUB HOOD
 N/A
 N/A
 N/A
 ZINC ALLOY
 YES
 N/A
 SCREW , NUT & SHIM

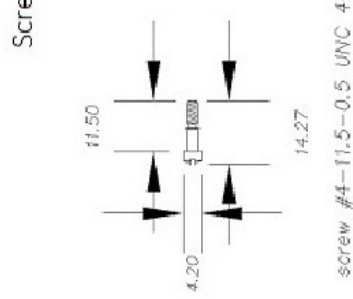
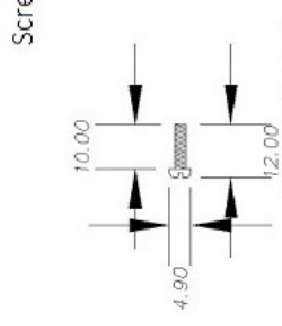
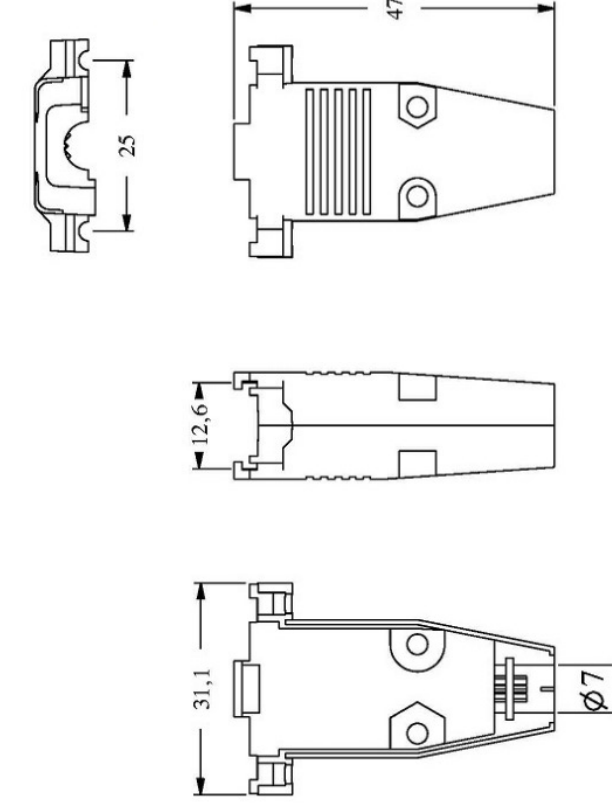

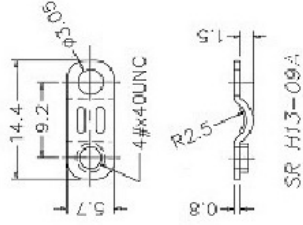
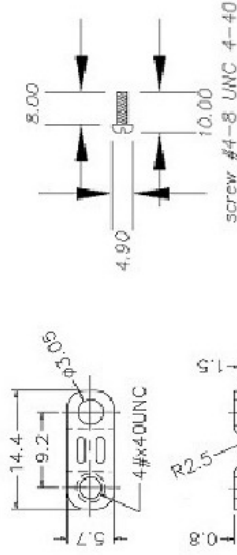

Screw C



Looking for pricing, stock, or lifecycle information?

Click below to explore more details on WIN SOURCE:

-  [View 40-9709HM](#) on WIN SOURCE
-  [Cinch Connectivity Solutions](#) Information

Optimize Your Supply Chain with WIN SOURCE Solutions

-  Global Sourcing Solution
-  Obsolete Management
-  Cost Control Management
-  Shortage Management
-  Alternative Solution
-  Excess Inventory Management