



**THE DATASHEET OF
IPTG039N15NM5ATMA1**



MOSFET

OptiMOS™ 5 Power-Transistor, 150 V

Features

- N-channel, normal level
- Very low on-resistance $R_{DS(on)}$
- Superior thermal resistance
- 100% avalanche tested
- Pb-free lead plating; RoHS compliant
- Halogen-free according to IEC61249-2-21

Product validation

Fully qualified according to JEDEC for Industrial Applications

Table 1 Key Performance Parameters

| Parameter | Value | Unit |
|------------------|-------|------------|
| V_{DS} | 150 | V |
| $R_{DS(on),max}$ | 3.9 | m Ω |
| I_D | 190 | A |
| Q_{oss} | 207 | nC |
| Q_G | 74 | nC |

PG-HSOG-8

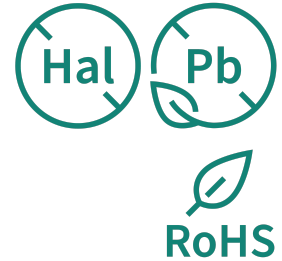
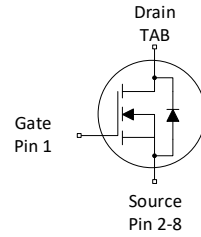
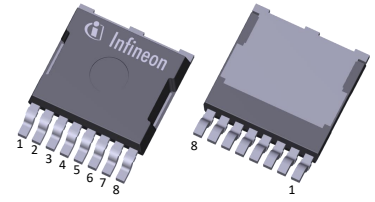

| Type/Ordering Code | Package | Marking | Related Links |
|--------------------|-----------|----------|---------------|
| IPTG039N15NM5 | PG-HSOG-8 | 039N15N5 | - |



Table of Contents

| | |
|---|----|
| Description | 1 |
| Maximum ratings | 3 |
| Thermal characteristics | 3 |
| Electrical characteristics | 4 |
| Electrical characteristics diagrams | 6 |
| Package Outlines | 10 |
| Revision History | 13 |
| Trademarks | 13 |
| Disclaimer | 13 |

1 Maximum ratings

unless otherwise specified

Table 2 Maximum ratings

| Parameter | Symbol | Values | | | Unit | Note/ Test Condition |
|--|----------------|--------|------|-------------------------|------|---|
| | | Min. | Typ. | Max. | | |
| Continuous drain current ¹⁾ | I_D | - | - | 190 134 128 21 | A | $V_{GS}=10\text{ V}, T_C=25\text{ °C}$ $V_{GS}=10\text{ V}, T_C=100\text{ °C}$ $V_{GS}=8\text{ V}, T_C=100\text{ °C}$ $V_{GS}=10\text{ V}, T_A=25\text{ °C}, R_{thJA}=40\text{ °C/W}^2)$ |
| Pulsed drain current ³⁾ | $I_{D,pulse}$ | - | - | 760 | A | $T_A=25\text{ °C}$ |
| Avalanche energy, single pulse ⁴⁾ | E_{AS} | - | - | 344 | mJ | $I_D=100\text{ A}, R_{GS}=25\text{ }\Omega$ |
| Gate source voltage | V_{GS} | -20 | - | 20 | V | - |
| Power dissipation | P_{tot} | - | - | 319 3.8 | W | $T_C=25\text{ °C}$ $T_A=25\text{ °C}, R_{thJA}=40\text{ °C/W}^2)$ |
| Operating and storage temperature | T_j, T_{stg} | -55 | - | 175 | °C | - |

¹⁾ Rating refers to the product only with datasheet specified absolute maximum values, maintaining case temperature as specified. For other case temperatures please refer to Diagram 2. De-rating will be required based on the actual environmental conditions.

²⁾ Device on 40 mm x 40 mm x 1.5 mm epoxy PCB FR4 with 6 cm² (one layer, 70 µm thick) copper area for drain connection. PCB is vertical in still air.

³⁾ See Diagram 3 for more detailed information

⁴⁾ See Diagram 13 for more detailed information

2 Thermal characteristics

Table 3 Thermal characteristics

| Parameter | Symbol | Values | | | Unit | Note/ Test Condition |
|---|------------|--------|------|------|------|----------------------|
| | | Min. | Typ. | Max. | | |
| Thermal resistance, junction - case | R_{thJC} | - | - | 0.47 | °C/W | - |
| Thermal resistance, junction - ambient, 6 cm ² cooling area ⁵⁾ | R_{thJA} | - | - | 40 | °C/W | - |
| Thermal resistance, junction - ambient, minimal footprint | R_{thJA} | - | - | 62 | °C/W | - |

⁵⁾ Device on 40 mm x 40 mm x 1.5 mm epoxy PCB FR4 with 6 cm² (one layer, 70 µm thick) copper area for drain connection. PCB is vertical in still air.

3 Electrical characteristics

unless otherwise specified

Table 4 Static characteristics

| Parameter | Symbol | Values | | | Unit | Note/ Test Condition |
|----------------------------------|---------------|--------|------------|------------|---------------|---|
| | | Min. | Typ. | Max. | | |
| Drain-source breakdown voltage | $V_{(BR)DSS}$ | 150 | - | - | V | $V_{GS}=0\text{ V}, I_D=1\text{ mA}$ |
| Gate threshold voltage | $V_{GS(th)}$ | 3.0 | 3.8 | 4.6 | V | $V_{DS}=V_{GS}, I_D=243\text{ }\mu\text{A}$ |
| Zero gate voltage drain current | I_{DSS} | - | 0.1 10 | 1.0 100 | μA | $V_{DS}=120\text{ V}, V_{GS}=0\text{ V}, T_j=25\text{ }^\circ\text{C}$ $V_{DS}=120\text{ V}, V_{GS}=0\text{ V}, T_j=125\text{ }^\circ\text{C}$ |
| Gate-source leakage current | I_{GSS} | - | 10 | 100 | nA | $V_{GS}=20\text{ V}, V_{DS}=0\text{ V}$ |
| Drain-source on-state resistance | $R_{DS(on)}$ | - | 3.5 3.8 | 3.9 4.3 | m Ω | $V_{GS}=10\text{ V}, I_D=50\text{ A}$ $V_{GS}=8\text{ V}, I_D=25\text{ A}$ |
| Gate resistance ⁶⁾ | R_G | - | 1.1 | 1.6 | Ω | - |
| Transconductance | g_{fs} | - | 110 | - | S | $ V_{DS} \geq 2 I_D R_{DS(on)max}, I_D=50\text{ A}$ |

⁶⁾ Defined by design. Not subject to production test.

Table 5 Dynamic characteristics

| Parameter | Symbol | Values | | | Unit | Note/ Test Condition |
|--|--------------|--------|------|------|------|--|
| | | Min. | Typ. | Max. | | |
| Input capacitance ⁷⁾ | C_{iss} | - | 5600 | 7300 | pF | $V_{GS}=0\text{ V}, V_{DS}=75\text{ V}, f=1\text{ MHz}$ |
| Output capacitance ⁷⁾ | C_{oss} | - | 1400 | 1930 | pF | $V_{GS}=0\text{ V}, V_{DS}=75\text{ V}, f=1\text{ MHz}$ |
| Reverse transfer capacitance ⁷⁾ | C_{rss} | - | 31 | 55 | pF | $V_{GS}=0\text{ V}, V_{DS}=75\text{ V}, f=1\text{ MHz}$ |
| Turn-on delay time | $t_{d(on)}$ | - | 19 | - | ns | $V_{DD}=75\text{ V}, V_{GS}=10\text{ V}, I_D=50\text{ A}, R_{G,ext}=1.6\text{ }\Omega$ |
| Rise time | t_r | - | 4.5 | - | ns | $V_{DD}=75\text{ V}, V_{GS}=10\text{ V}, I_D=50\text{ A}, R_{G,ext}=1.6\text{ }\Omega$ |
| Turn-off delay time | $t_{d(off)}$ | - | 23.5 | - | ns | $V_{DD}=75\text{ V}, V_{GS}=10\text{ V}, I_D=50\text{ A}, R_{G,ext}=1.6\text{ }\Omega$ |
| Fall time | t_f | - | 5.5 | - | ns | $V_{DD}=75\text{ V}, V_{GS}=10\text{ V}, I_D=50\text{ A}, R_{G,ext}=1.6\text{ }\Omega$ |

⁷⁾ Defined by design. Not subject to production test.

Table 6 Gate charge characteristics ⁸⁾

| Parameter | Symbol | Values | | | Unit | Note/ Test Condition |
|------------------------------------|---------------|--------|------|------|------|---|
| | | Min. | Typ. | Max. | | |
| Gate to source charge | Q_{gs} | - | 30 | - | nC | $V_{DD}=75\text{ V}, I_D=50\text{ A}, V_{GS}=0\text{ to }10\text{ V}$ |
| Gate charge at threshold | $Q_{g(th)}$ | - | 21 | - | nC | $V_{DD}=75\text{ V}, I_D=50\text{ A}, V_{GS}=0\text{ to }10\text{ V}$ |
| Gate to drain charge ⁹⁾ | Q_{gd} | - | 15 | 22 | nC | $V_{DD}=75\text{ V}, I_D=50\text{ A}, V_{GS}=0\text{ to }10\text{ V}$ |
| Switching charge | Q_{sw} | - | 23 | - | nC | $V_{DD}=75\text{ V}, I_D=50\text{ A}, V_{GS}=0\text{ to }10\text{ V}$ |
| Gate charge total ⁹⁾ | Q_g | - | 74 | 93 | nC | $V_{DD}=75\text{ V}, I_D=50\text{ A}, V_{GS}=0\text{ to }10\text{ V}$ |
| Gate plateau voltage | $V_{plateau}$ | - | 5.4 | - | V | $V_{DD}=75\text{ V}, I_D=50\text{ A}, V_{GS}=0\text{ to }10\text{ V}$ |
| Output charge ⁹⁾ | Q_{oss} | - | 207 | 275 | nC | $V_{DS}=75\text{ V}, V_{GS}=0\text{ V}$ |

⁸⁾ See "Gate charge waveforms" for parameter definition

⁹⁾ Defined by design. Not subject to production test.

Table 7 Reverse diode

| Parameter | Symbol | Values | | | Unit | Note/ Test Condition |
|--|---------------|--------|------|------|------|--|
| | | Min. | Typ. | Max. | | |
| Diode continuous forward current | I_S | - | - | 190 | A | $T_C=25\text{ °C}$ |
| Diode pulse current | $I_{S,pulse}$ | - | - | 760 | A | $T_C=25\text{ °C}$ |
| Diode forward voltage | V_{SD} | - | 0.81 | 1.0 | V | $V_{GS}=0\text{ V}, I_F=50\text{ A}, T_j=25\text{ °C}$ |
| Reverse recovery time ¹⁰⁾ | t_{rr} | - | 53.5 | 107 | ns | $V_R=75\text{ V}, I_F=50\text{ A}, di_F/dt=100\text{ A}/\mu\text{s}$ |
| Reverse recovery charge ¹⁰⁾ | Q_{rr} | - | 77 | 155 | nC | $V_R=75\text{ V}, I_F=50\text{ A}, di_F/dt=100\text{ A}/\mu\text{s}$ |

¹⁰⁾ Defined by design. Not subject to production test.

4 Electrical characteristics diagrams

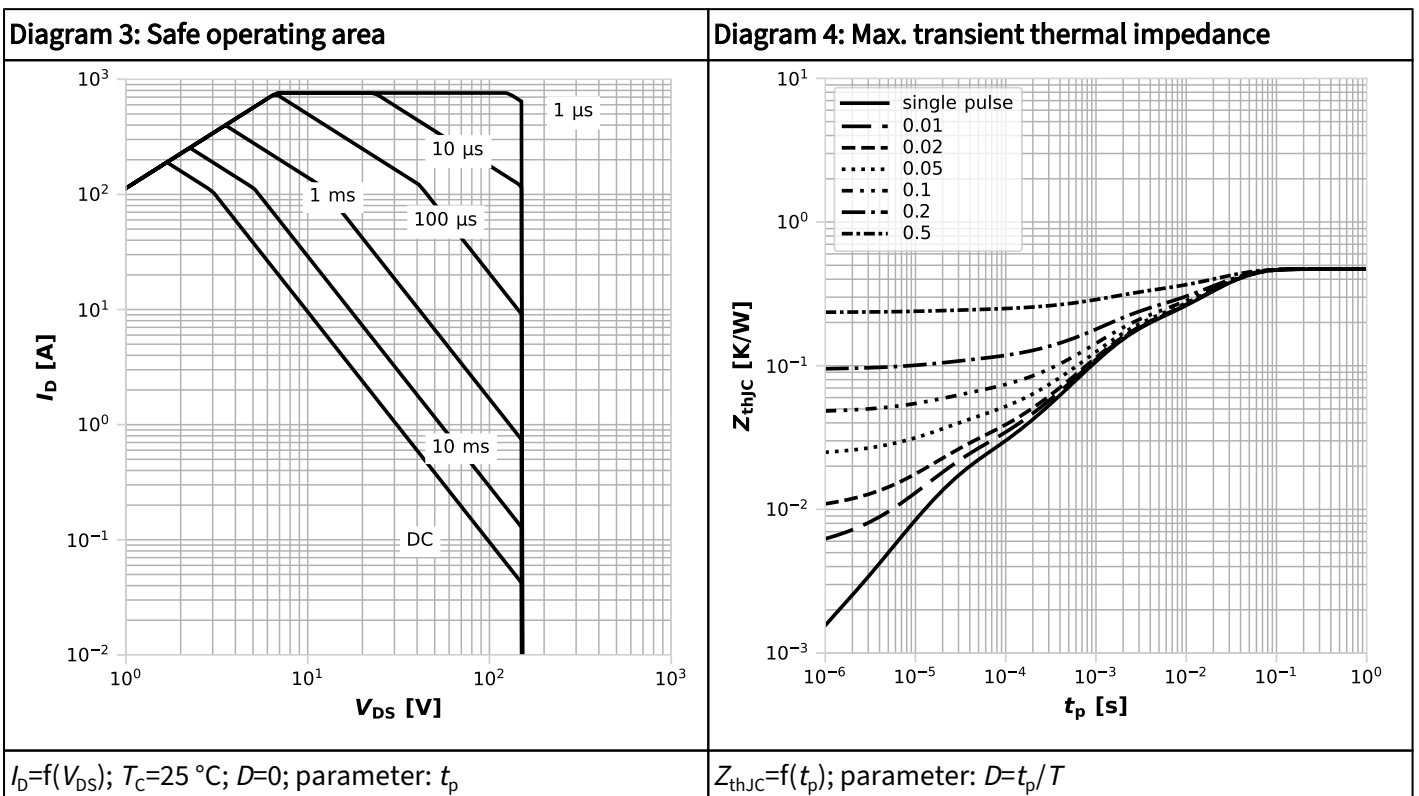
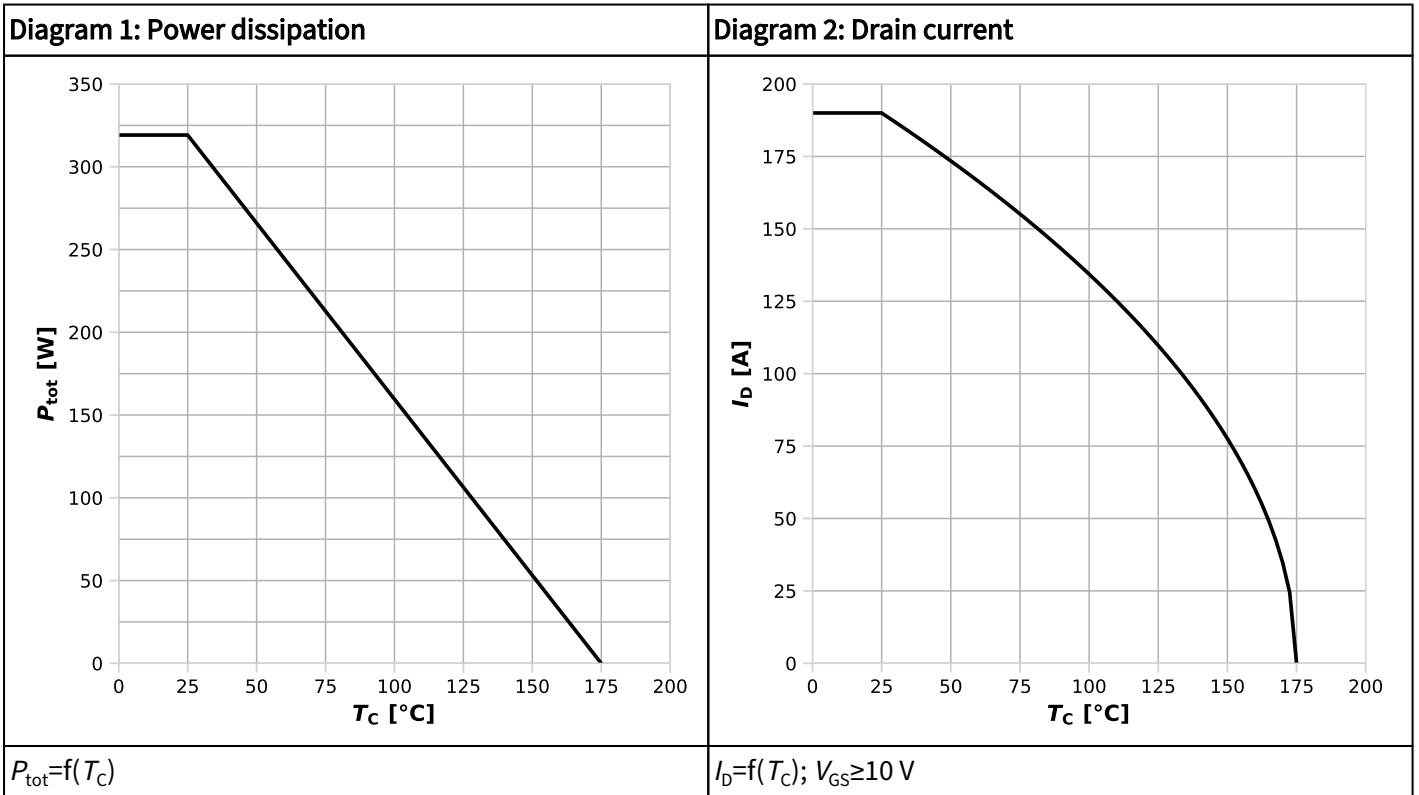
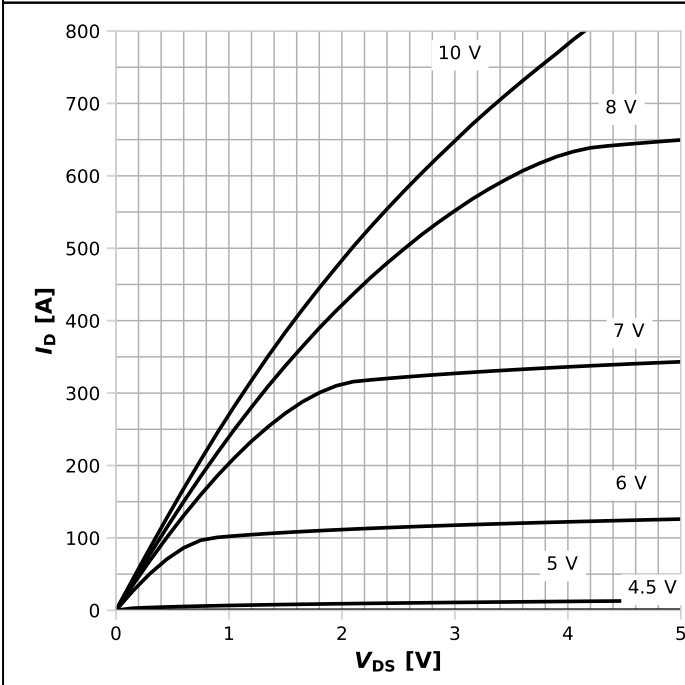
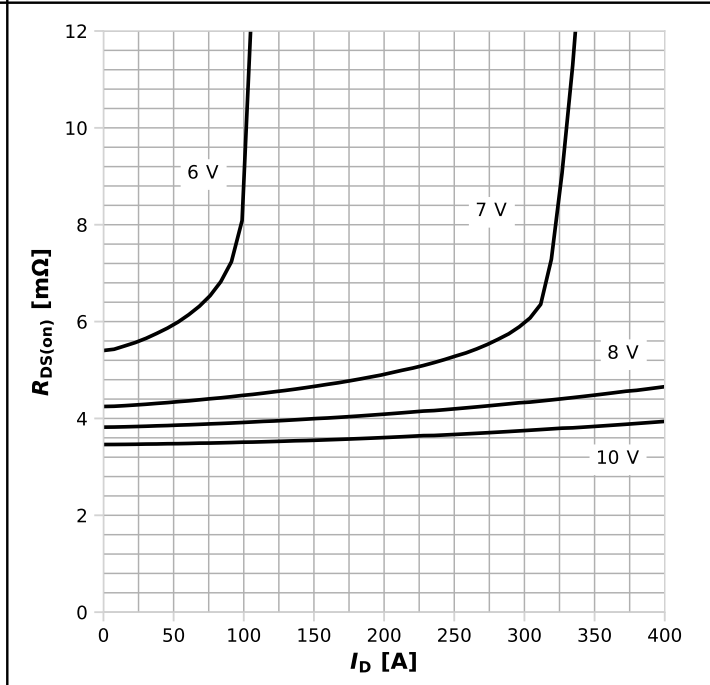

Diagram 5: Typ. output characteristics



$I_D = f(V_{DS}), T_j = 25\text{ °C};$ parameter: V_{GS}

Diagram 6: Typ. drain-source on resistance



$R_{DS(on)} = f(I_D), T_j = 25\text{ °C};$ parameter: V_{GS}

Diagram 7: Typ. transfer characteristics

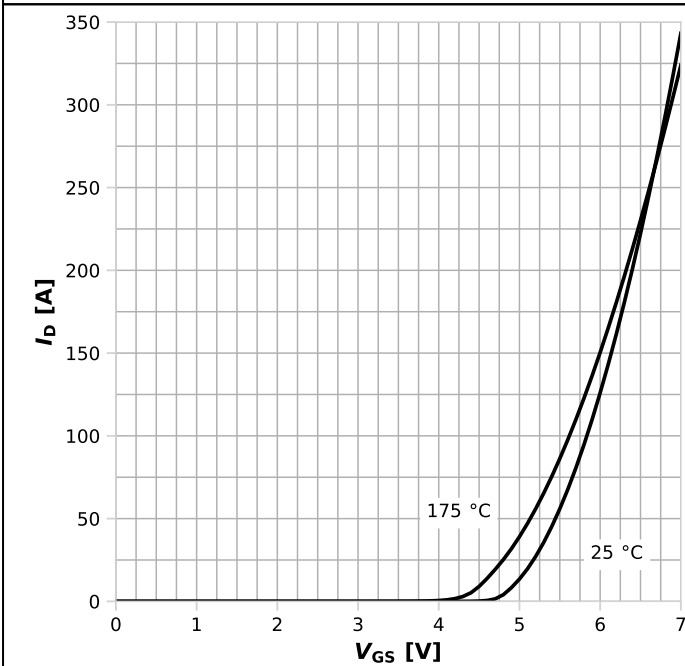

$I_D = f(V_{GS}), |V_{DS}| > 2|I_D|R_{DS(on)max};$ parameter: T_j

Diagram 8: Typ. drain-source on resistance

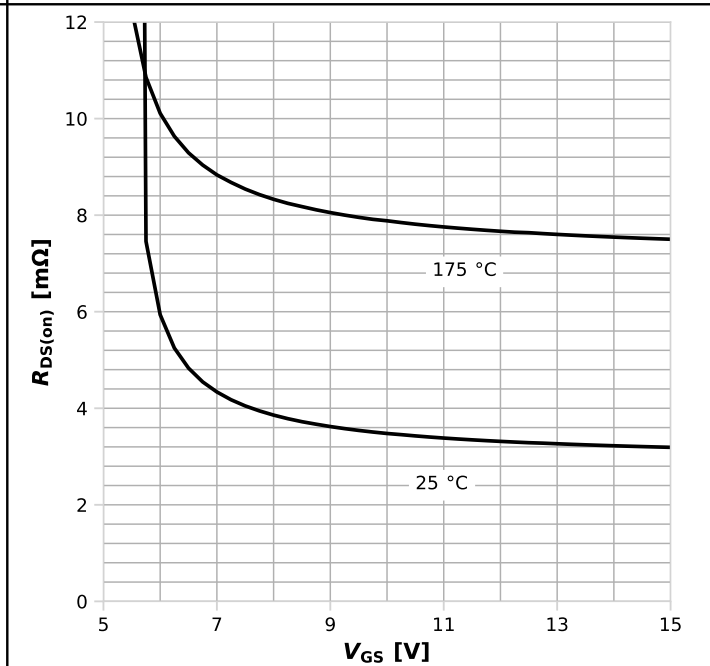

$R_{DS(on)} = f(V_{GS}), I_D = 50\text{ A};$ parameter: T_j

Diagram 9: Normalized drain-source on resistance

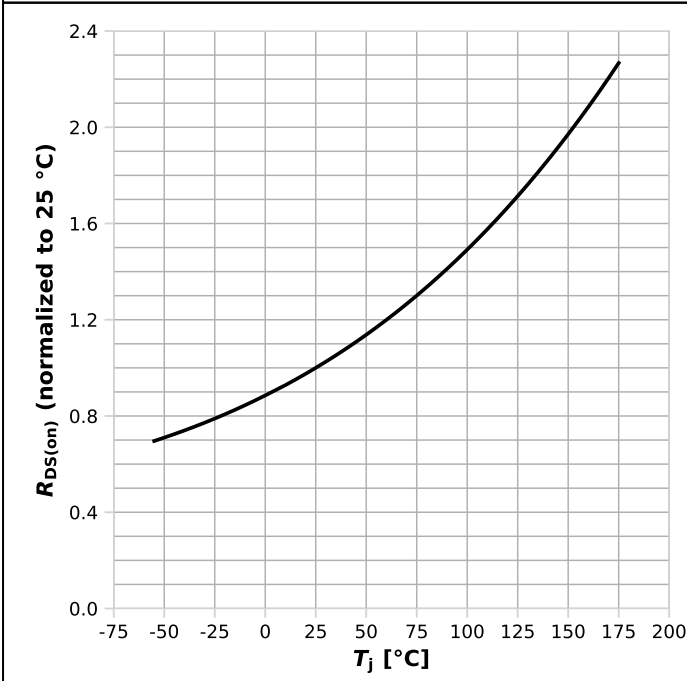

$R_{DS(on)}=f(T_j), I_D=50\text{ A}, V_{GS}=10\text{ V}$

Diagram 10: Typ. gate threshold voltage

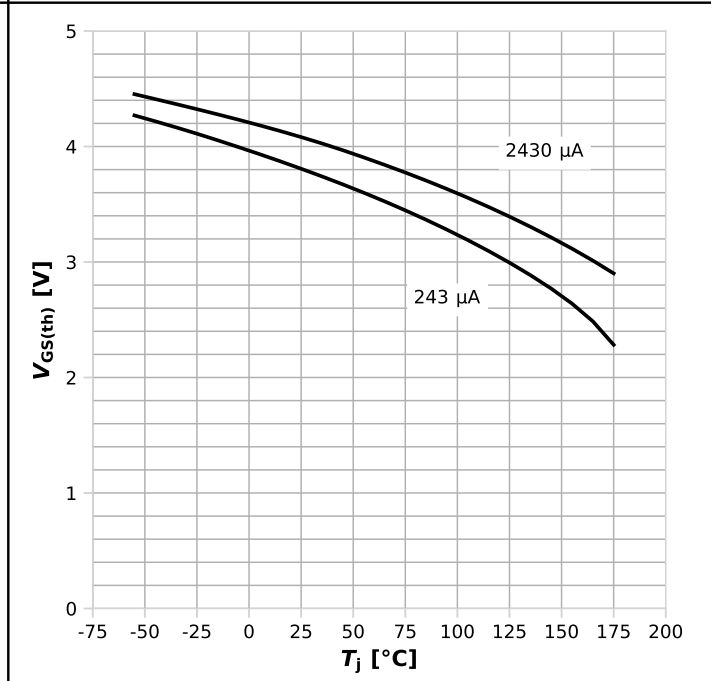

$V_{GS(th)}=f(T_j), V_{GS}=V_{DS};$ parameter: I_D

Diagram 11: Typ. capacitances

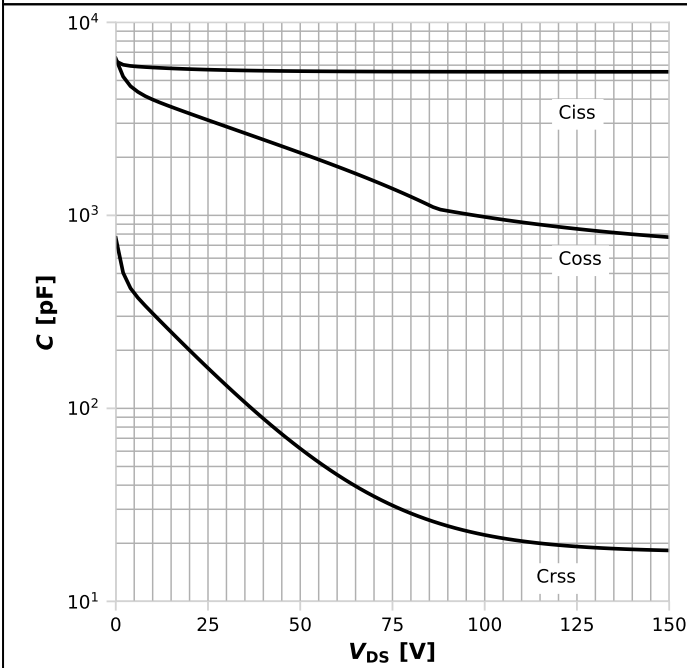

$C=f(V_{DS}); V_{GS}=0\text{ V}; f=1\text{ MHz}$

Diagram 12: Forward characteristics of reverse diode

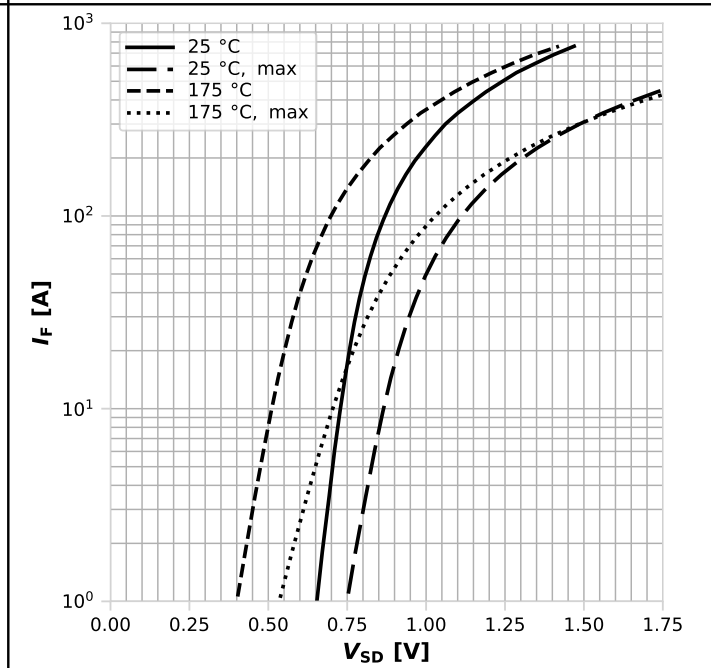

$I_F=f(V_{SD});$ parameter: T_j

Diagram 13: Avalanche characteristics

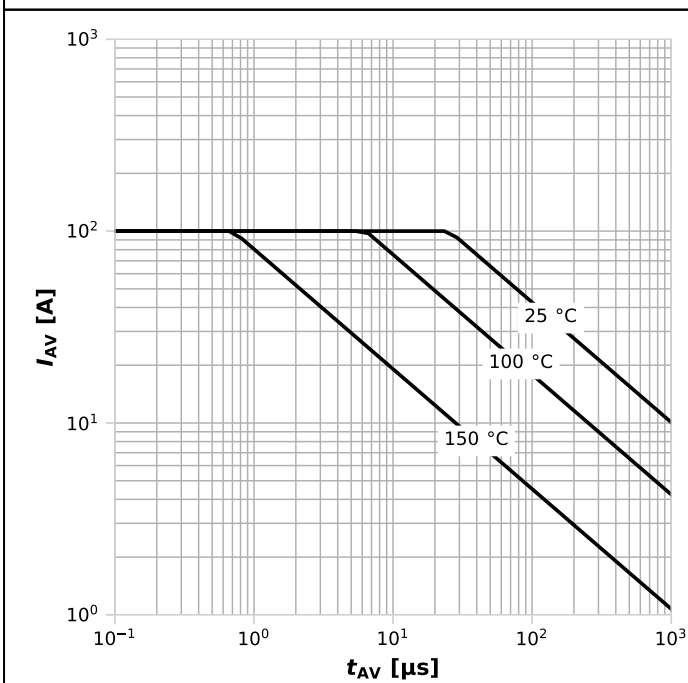

$I_{AS}=f(t_{AV}); R_{GS}=25 \Omega$; parameter: $T_{j,start}$

Diagram 14: Typ. gate charge

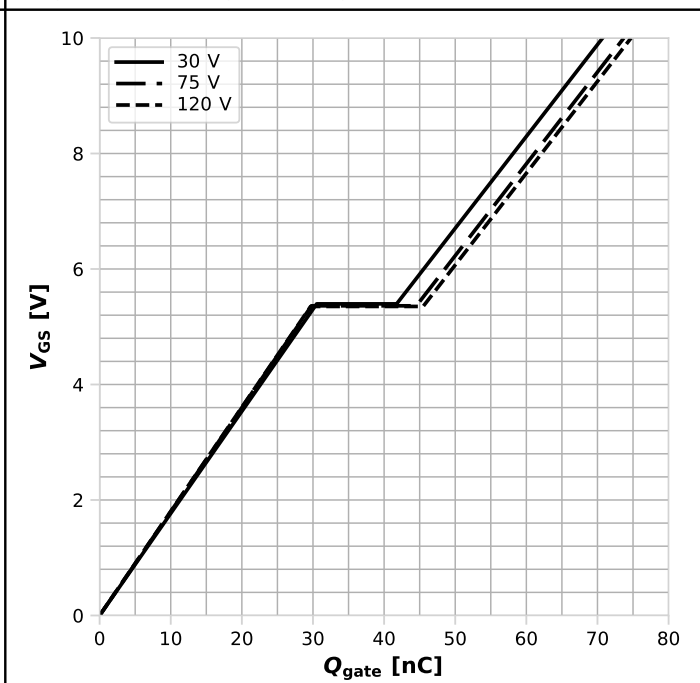

$V_{GS}=f(Q_{gate}), I_D=50$ A pulsed, $T_j=25$ °C; parameter: V_{DD}

Diagram 15: Drain-source breakdown voltage

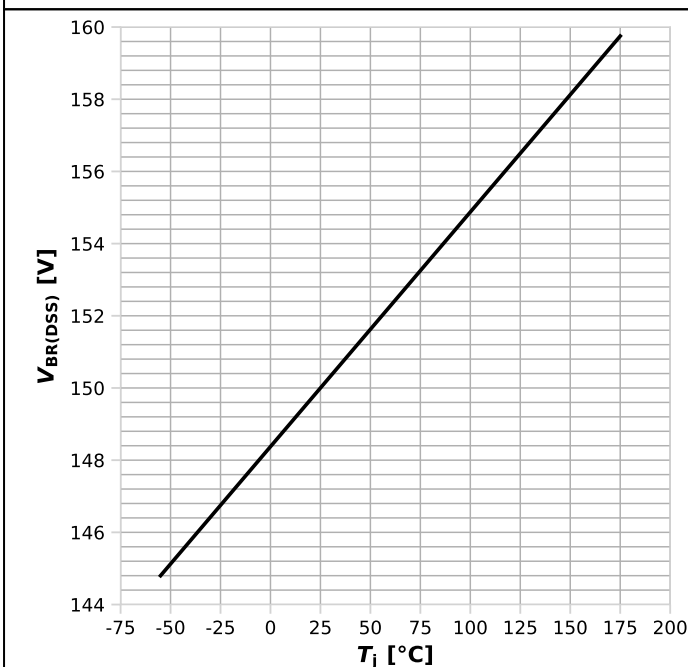

$V_{BR(DSS)}=f(T_j); I_D=1$ mA

Gate charge waveforms

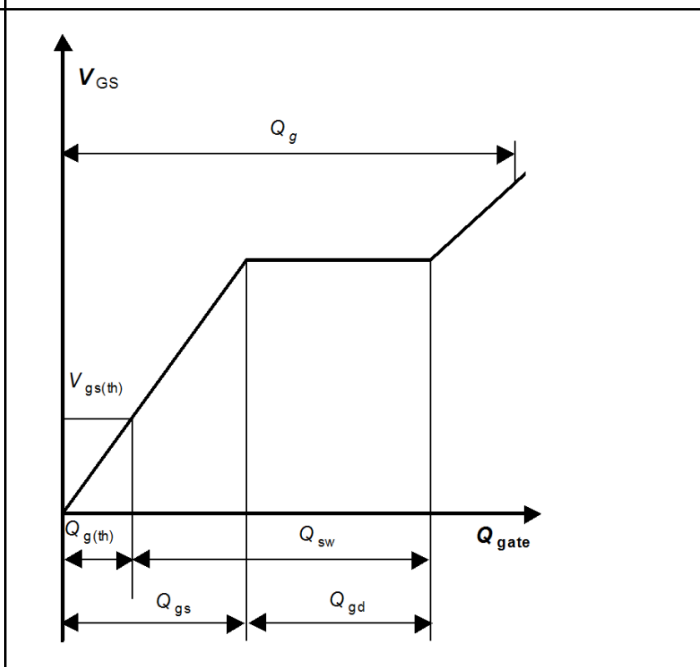

-

5 Package Outlines

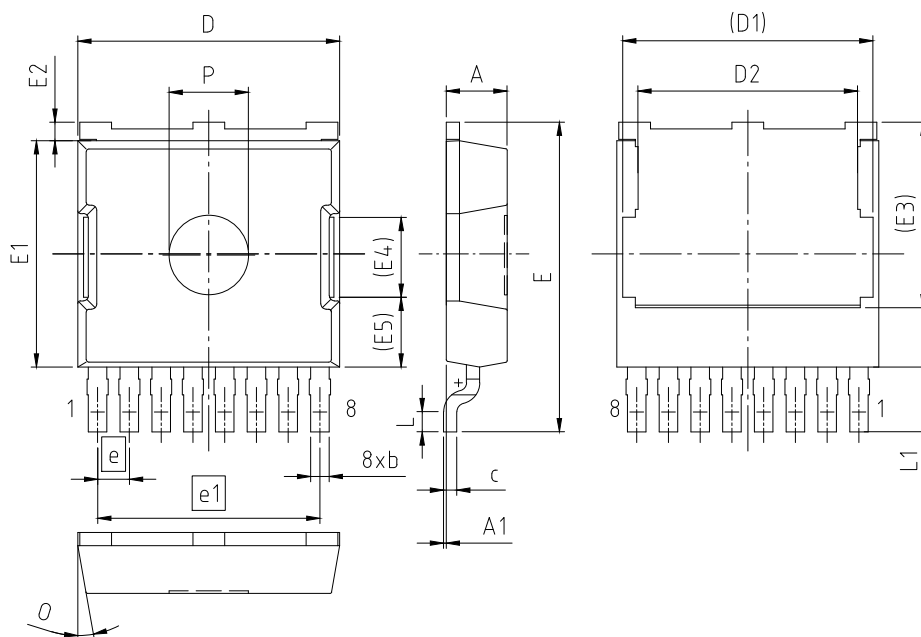

| PACKAGE - GROUP NUMBER: PG-HSOG-8-U01 | | | | | |
|--|-------------|-------|------------|-------------|------|
| DIMENSIONS | MILLIMETERS | | DIMENSIONS | MILLIMETERS | |
| | MIN. | MAX. | | MIN. | MAX. |
| A | 2.20 | 2.40 | e | 1.20 | |
| A1 | 0.00 | 0.10 | e1 | 8.40 | |
| b | 0.60 | 0.80 | L | 0.66 | 0.86 |
| c | 0.40 | 0.60 | L1 | 2.44 | 2.74 |
| D | 9.70 | 10.10 | O | 8° | 12° |
| D1 | 9.46 | | P | 2.90 | 3.10 |
| D2 | 8.20 | 8.40 | | | |
| E | 11.50 | 11.90 | | | |
| E1 | 8.45 | 8.75 | | | |
| E2 | 0.50 | 0.90 | | | |
| E3 | 7.01 | | | | |
| E4 | 3.02 | | | | |
| E5 | 2.64 | | | | |

NOTE: DIMENSIONS DO NOT INCLUDE MOLD FLASH, PROTRUSION OR GATE BURRS

Figure 1 Outline PG-HSOG-8, dimensions in mm

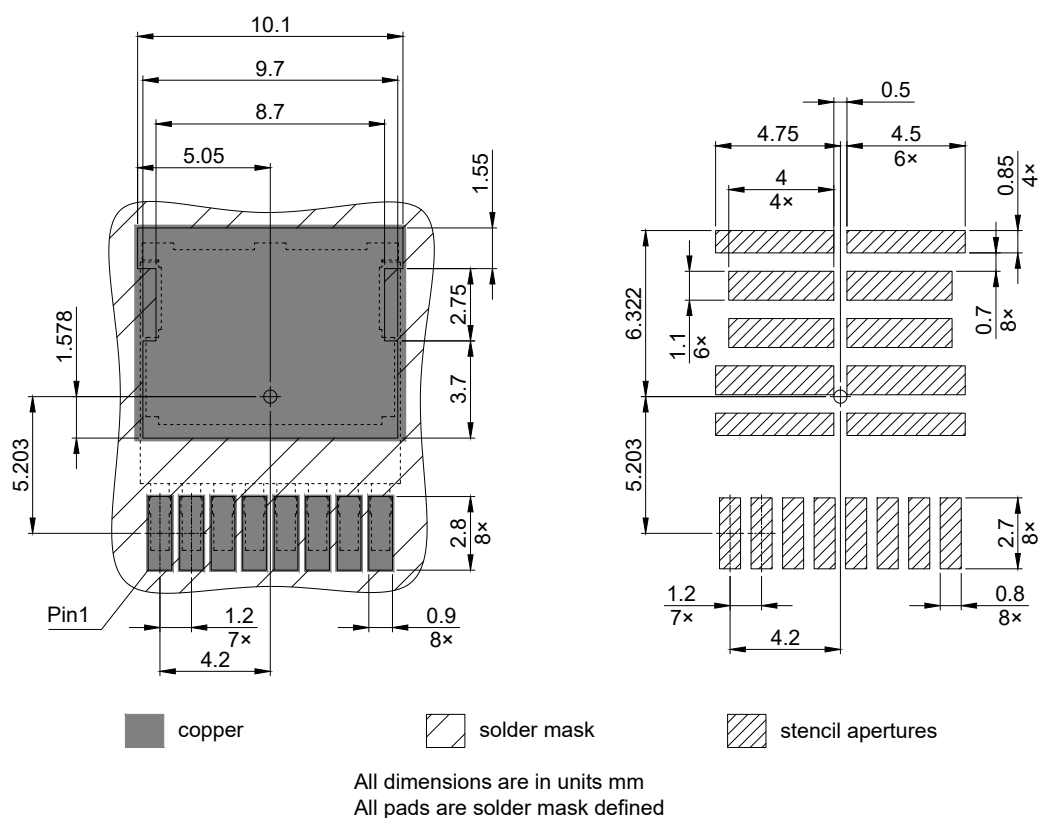
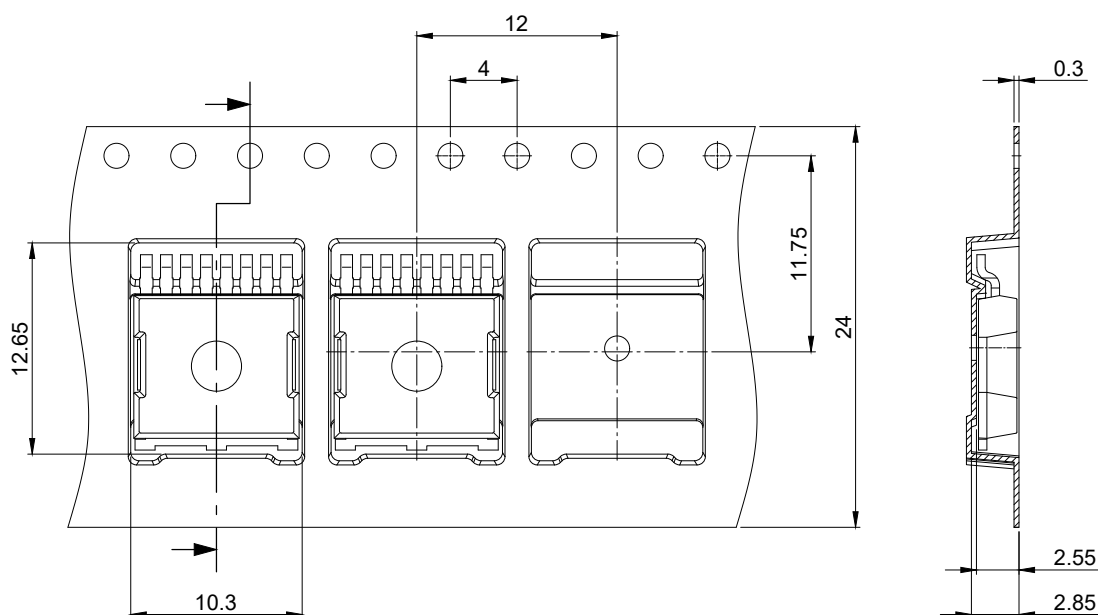

Figure 2 Outline PG-HSOG-8, dimensions in mm



All dimensions are in units mm
The drawing is in compliance with ISO 128-30, Projection Method 1 []

Figure 3 Outline PG-HSOG-8, dimensions in mm

Revision History

IPTG039N15NM5

Revision 2024-06-11, Rev. 2.2

Previous Revision

| Revision | Date | Subjects (major changes since last revision) |
|----------|------------|--|
| 2.0 | 2022-05-05 | Release of final version |
| 2.1 | 2023-03-13 | Update Coss max |
| 2.2 | 2024-06-11 | Update Rg |

Trademarks

All referenced product or service names and trademarks are the property of their respective owners.

We Listen to Your Comments Any information within this document that you feel is wrong, unclear or missing at all? Your feedback will help us to continuously improve the quality of this document. Please send your proposal (including a reference to this document) to: erratum@infineon.com

Published by

Infineon Technologies AG
81726 München, Germany
© 2024 Infineon Technologies AG
All Rights Reserved.

Legal Disclaimer

The information given in this document shall in no event be regarded as a guarantee of conditions or characteristics ("Beschaffenheitsgarantie"). With respect to any examples, hints or any typical values stated herein and/or any information regarding the application of the product, Infineon Technologies hereby disclaims any and all warranties and liabilities of any kind, including without limitation warranties of non-infringement of intellectual property rights of any third party.

In addition, any information given in this document is subject to customer's compliance with its obligations stated in this document and any applicable legal requirements, norms and standards concerning customer's products and any use of the product of Infineon Technologies in customer's applications.

The data contained in this document is exclusively intended for technically trained staff. It is the responsibility of customer's technical departments to evaluate the suitability of the product for the intended application and the completeness of the product information given in this document with respect to such application.

Information

For further information on technology, delivery terms and conditions and prices please contact your nearest Infineon Technologies Office (www.infineon.com).



Warnings

Due to technical requirements, components may contain dangerous substances. For information on the types in question, please contact the nearest Infineon Technologies Office.





The Infineon Technologies component described in this Data Sheet may be used in life-support devices or systems and/or automotive, aviation and aerospace applications or systems only with the express written approval of Infineon Technologies, if a failure of such components can reasonably be expected to cause the failure of that life-support, automotive, aviation and aerospace device or system or to affect the safety or effectiveness of that device or system. Life support devices or systems are intended to be implanted in the human body or to support and/or maintain and sustain and/or protect human life. If they fail, it is reasonable to assume that the health of the user or other persons may be endangered.

Looking for pricing, stock, or lifecycle information?

Click below to explore more details on WIN SOURCE:

-  [View IPTG039N15NM5ATMA1 on WIN SOURCE](#)
-  [Infineon Technologies Information](#)

Optimize Your Supply Chain with WIN SOURCE Solutions

-  Global Sourcing Solution
-  Obsolete Management
-  Cost Control Management
-  Shortage Management
-  Alternative Solution
-  Excess Inventory Management