



**THE DATASHEET OF  
LTC3370EUH#TRPBF**



## FEATURES

- **8 × 1A Power Stages Configurable as 2, 3, or 4 Output Channels**
- **8 Unique Output Configurations (1A to 4A Per Channel)**
- **Independent  $V_{IN}$  Supplies for Each DC/DC (2.25V to 5.5V)**
- **Low Total No Load Supply Current:**
  - **Zero Current In Shutdown (All Channels Off)**
  - **63 $\mu$ A One Channel Active in Burst Mode<sup>®</sup> Operation**
  - **18 $\mu$ A Per Additional Channel**
- **Precision Enable Pin Thresholds for Autonomous Sequencing**
- **1MHz to 3MHz RT Programmable Frequency (2MHz Default) or PLL Synchronization**
- **Temp Monitor Indicates Die Temperature**
- **PGOODALL Pin Indicates All Enabled Bucks Are in Regulation**
- **32-Lead 5mm × 5mm QFN Package**

## APPLICATIONS

- **General Purpose Multichannel Power Supplies:**  
 Automotive, Industrial, Distributed Power Systems

## DESCRIPTION

The **LTC<sup>®</sup>3370** is a highly flexible multioutput power supply IC. The device includes four synchronous buck converters, configured to share eight 1A power stages, each of which is powered from independent 2.25V to 5.5V inputs.

The DC/DCs are assigned to one of eight power configurations via pin programmable C1-C3 pins. The common buck switching frequency may be programmed with an external resistor, synchronized to an external oscillator, or set to a default internal 2MHz clock.

The operating mode for all DC/DCs may be programmed via the PLL/MODE pin for Burst Mode or forced continuous mode operation. A PGOODALL output indicates when all enabled DC/DCs are within a specified percentage of their final output value.

To reduce input noise, the buck converters are phased in 90° steps. Precision enable pin thresholds facilitate reliable power-up sequencing. The LTC3370 is available in a 32-lead 5mm × 5mm QFN package.

LT, LT, LTC, LTM, Linear Technology and the Linear logo are registered trademarks of Linear Technology Corporation. All other trademarks are the property of their respective owners.

## TYPICAL APPLICATION

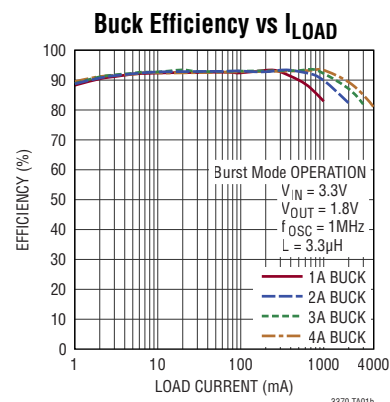
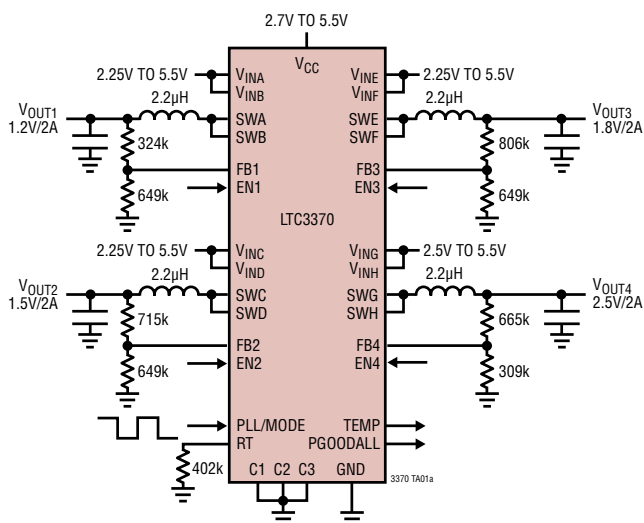

C3	C2	C1	BUCK1	BUCK2	BUCK3	BUCK4
0	0	0	2A	2A	2A	2A
0	0	1	3A	1A	2A	2A
0	1	0	3A	1A	1A	3A
0	1	1	4A	1A	1A	2A
1	0	0	3A	2A	-	3A
1	0	1	4A	-	2A	2A
1	1	0	4A	-	1A	3A
1	1	1	4A	-	-	4A

3370fb

## TABLE OF CONTENTS

Features .....	1
Applications .....	1
Typical Application .....	1
Description.....	1
Absolute Maximum Ratings.....	3
Order Information.....	3
Pin Configuration .....	3
Electrical Characteristics.....	4
Typical Performance Characteristics .....	6
Pin Functions .....	12
Block Diagram.....	14
Operation.....	15
Buck Switching Regulators.....	15
Buck Regulators with Combined Power Stages.....	15
Power Failure Reporting Via PGOODALL Pin.....	16
Temperature Monitoring and Overtemperature Protection.....	16
Programming the Operating Frequency.....	16
Applications Information .....	17
Buck Switching Regulator Output Voltage and Feedback Network .....	17
Buck Regulators .....	17
Combined Buck Power Stages.....	17
Input and Output Decoupling Capacitor Selection.....	17
PCB Considerations.....	19
Typical Applications .....	20
Package Description .....	23
Typical Application .....	24
Related Parts .....	24

## ABSOLUTE MAXIMUM RATINGS

(Note 1)

$V_{INA-H}$ , FB1-4, EN1-4,  $V_{CC}$ , PGOODALL,  
 RT, PLL/MODE, C1-3 .....  $-0.3V$  to  $6V$   
 TEMP .....  $-0.3V$  to Lesser of ( $V_{CC} + 0.3V$ ) or  $6V$   
 $I_{PGOODALL}$  .....  $5mA$   
 Operating Junction Temperature Range  
 (Notes 2, 3) .....  $-40^{\circ}C$  to  $150^{\circ}C$   
 Storage Temperature Range .....  $-65^{\circ}C$  to  $150^{\circ}C$

## PIN CONFIGURATION

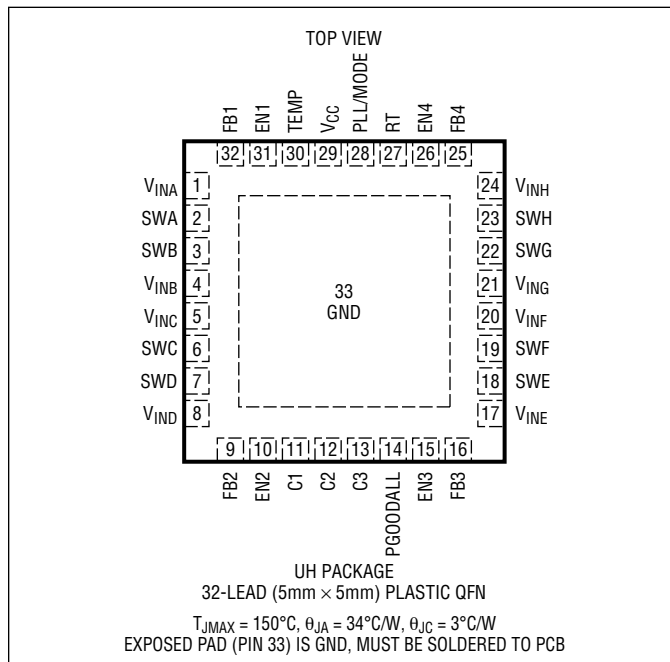

## ORDER INFORMATION

(<http://www.linear.com/product/LTC3370#orderinfo>)

LEAD FREE FINISH	TAPE AND REEL	PART MARKING*	PACKAGE DESCRIPTION	TEMPERATURE RANGE
LTC3370EUH#PBF	LTC3370EUH#TRPBF	3370	32-Lead (5mm × 5mm) Plastic QFN	$-40^{\circ}C$ to $125^{\circ}C$
LTC3370IUH#PBF	LTC3370IUH#TRPBF	3370	32-Lead (5mm × 5mm) Plastic QFN	$-40^{\circ}C$ to $125^{\circ}C$
LTC3370HUH#PBF	LTC3370HUH#TRPBF	3370	32-Lead (5mm × 5mm) Plastic QFN	$-40^{\circ}C$ to $150^{\circ}C$

Consult LTC Marketing for parts specified with wider operating temperature ranges. \*The temperature grade is identified by a label on the shipping container.

For more information on lead free part marking, go to: <http://www.linear.com/leadfree/>

For more information on tape and reel specifications, go to: <http://www.linear.com/tapeandreel/>. Some packages are available in 500 unit reels through designated sales channels with #TRMPBF suffix.

## ELECTRICAL CHARACTERISTICS

The ● denotes the specifications which apply over the full operating junction temperature range, otherwise specifications are at  $T_A = 25^\circ\text{C}$  (Note 2).  $V_{CC} = V_{INA-H} = 3.3\text{V}$ , unless otherwise specified.

SYMBOL	PARAMETER	CONDITIONS	MIN	TYP	MAX	UNITS
$V_{CC}$	$V_{CC}$ Voltage Range		● 2.7		5.5	V
$V_{CC(UVLO)}$	Undervoltage Threshold on $V_{CC}$	$V_{CC}$ Voltage Falling	● 2.325	2.45	2.575	V
		$V_{CC}$ Voltage Rising	● 2.425	2.55	2.675	V
$I_{VCC(ALLOFF)}$	$V_{CC}$ Input Supply Current	All Switching Regulators in Shutdown		0	2.5	$\mu\text{A}$
$I_{VCC}$	$V_{CC}$ Input Supply Current	One Buck Active PLL/MODE = 0V, $R_T = 400\text{k}$ , $V_{FB(BUCK)} = 0.85\text{V}$ PLL/MODE = 2MHz		45 170	70 250	$\mu\text{A}$ $\mu\text{A}$
$f_{OSC}$	Internal Oscillator Frequency	$V_{RT} = V_{CC}$ , PLL/MODE = 0V	● 1.8	2	2.2	MHz
		$V_{RT} = V_{CC}$ , PLL/MODE = 0V	● 1.75	2	2.25	MHz
		$R_T = 400\text{k}$ , PLL/MODE = 0V	● 1.8	2	2.2	MHz
$f_{PLL/MODE}$	Synchronization Frequency	$t_{LOW}$ , $t_{HIGH} > 40\text{ns}$	● 1		3	MHz
$V_{PLL/MODE}$	PLL/MODE Level High	For Synchronization	● 1.2			V
	PLL/MODE Level Low	For Synchronization	●		0.4	V
$V_{RT}$	RT Servo Voltage	$R_T = 400\text{k}$	● 780	800	820	mV
<b>Temp Monitor</b>						
$V_{TEMP(ROOM)}$	TEMP Voltage at $25^\circ\text{C}$		180	220	260	mV
$\Delta V_{TEMP/^\circ\text{C}}$	$V_{TEMP}$ Slope			7		mV/ $^\circ\text{C}$
OT	Overtemperature Shutdown			170		$^\circ\text{C}$
OT Hyst	Overtemperature Hysteresis			10		$^\circ\text{C}$
<b>1A Buck Regulators</b>						
$V_{IN}$	Buck Input Voltage Range		● 2.25		5.5	V
$V_{OUT}$	Buck Output Voltage Range		● $V_{FB}$		$V_{IN}$	V
$V_{IN(UVLO)}$	Undervoltage Threshold on $V_{IN}$	$V_{IN}$ Voltage Falling	● 1.95	2.05	2.15	V
		$V_{IN}$ Voltage Rising	● 2.05	2.15	2.25	V
$I_{VIN}$	Burst Mode Operation Input Current	$V_{FB} = 0.85\text{V}$ (Note 4)		18	30	$\mu\text{A}$
	Forced Continuous Mode Operation	$I_{SW(BUCK)} = 0\mu\text{A}$ , $FB = 0\text{V}$		400	600	$\mu\text{A}$
	Input Current			0	2.5	$\mu\text{A}$
	Shutdown Input Current					$\mu\text{A}$
$I_{FWD}$	PMOS Current Limit	(Note 5)	1.9	2.3	2.7	A
$V_{FB1}$	Feedback Regulation Voltage for Buck 1		● 792	800	808	mV
$V_{FB}$	Feedback Regulation Voltage for BUCKS 2-4		● 780	800	820	mV
$I_{FB}$	Feedback Leakage Current	$V_{FB} = 0.85\text{V}$		-50	50	nA
$D_{MAX}$	Maximum Duty Cycle	$V_{FB} = 0\text{V}$	● 100			%
$R_{PMOS}$	PMOS On-Resistance	$I_{SW} = 100\text{mA}$		300		$\text{m}\Omega$
$R_{NMOS}$	NMOS On-Resistance	$I_{SW} = -100\text{mA}$		240		$\text{m}\Omega$
$I_{LEAKP}$	PMOS Leakage Current	EN = 0		-2	2	$\mu\text{A}$
$I_{LEAKN}$	NMOS Leakage Current	EN = 0		-2	2	$\mu\text{A}$
$t_{SS}$	Soft-Start Time			1		ms
$V_{PGOOD(FALL)}$	Falling PGOOD Threshold for Buck 1	% of Regulated $V_{FB}$	96.8	98	99.2	%
	Falling PGOOD Threshold for BUCKS 2 to 4	% of Regulated $V_{FB}$	93	95	97	%
$V_{PGOOD(HYS)}$	PGOOD Hysteresis for BUCKS 1 to 4	% of Regulated $V_{FB}$		0.3		%

## ELECTRICAL CHARACTERISTICS

The ● denotes the specifications which apply over the full operating junction temperature range, otherwise specifications are at  $T_A = 25^\circ\text{C}$  (Note 2).  $V_{CC} = V_{INA-H} = 3.3\text{V}$ , unless otherwise specified.

SYMBOL	PARAMETER	CONDITIONS	MIN	TYP	MAX	UNITS
<b>Buck Regulators Combined</b>						
$I_{FWD2}$	PMOS Current Limit	2 Buck Power Stages Combined (Note 5)		4.6		A
$I_{FWD3}$	PMOS Current Limit	3 Buck Power Stages Combined (Note 5)		6.9		A
$I_{FWD4}$	PMOS Current Limit	4 Buck Power Stages Combined (Note 5)		9.2		A
<b>Interface Logic Pins (PGOODALL, PLL/MODE, CT, C1, C2, C3)</b>						
$I_{OH}$	Output High Leakage Current	PGOODALL 5.5V at Pin			1	$\mu\text{A}$
$V_{OL}$	Output Low Voltage	PGOODALL 3mA into Pin		0.1	0.4	V
$V_{IL}$	C1, C2, C3 Input Low Threshold		●		0.4	V
$V_{IH}$	PLL/MODE, CT, C1, C2, C3 Input High Threshold		●	$V_{CC} - 0.4$		V
$V_{IL}$	PLL/MODE Input Low Threshold		●		$V_{CC} - 1.2$	V
<b>Interface Logic Pins (EN1, EN2, EN3, EN4)</b>						
$V_{HI(ALL\ OFF)}$	Enable Rising Threshold	All Regulators Disabled	●	730	1200	mV
$V_{HI}$	Enable Rising Threshold	At Least One Regulator Enabled	●	400	420	mV
$V_{LO}$	Enable Falling Threshold			340	375	mV
$I_{EN}$	Enable Pin Leakage Current	EN = 3.3V			1	$\mu\text{A}$

**Note 1:** Stresses beyond those listed under Absolute Maximum Ratings may cause permanent damage to the device. Exposure to any Absolute Maximum Rating condition for extended periods may affect device reliability and lifetime.

**Note 2:** The LTC3370 is tested under pulsed load conditions such that  $T_J \approx T_A$ . The LTC3370E is guaranteed to meet specifications from  $0^\circ\text{C}$  to  $85^\circ\text{C}$  junction temperature. Specifications over the  $-40^\circ\text{C}$  to  $125^\circ\text{C}$  operating junction temperature range are assured by design, characterization and correlation with statistical process controls. The LTC3370I is guaranteed over the  $-40^\circ\text{C}$  to  $125^\circ\text{C}$  operating junction temperature range. The LTC3370H is guaranteed over the  $-40^\circ\text{C}$  to  $150^\circ\text{C}$  operating junction temperature range. High junction temperatures degrade operating lifetimes; operating lifetime is derated for junction temperatures greater than  $125^\circ\text{C}$ . Note that the maximum ambient temperature consistent with these specifications is determined by specific operating conditions in conjunction with board layout, the rated package thermal impedance and other environmental factors. The junction temperature ( $T_J$  in  $^\circ\text{C}$ ) is calculated from the ambient temperature ( $T_A$  in  $^\circ\text{C}$ ) and power dissipation ( $P_D$  in Watts) according to the formula:

$$T_J = T_A + (P_D \cdot \theta_{JA})$$

where  $\theta_{JA}$  (in  $^\circ\text{C}/\text{W}$ ) is the package thermal impedance.

**Note 3:** The LTC3370 includes overtemperature protection which protects the device during momentary overload conditions. Junction temperatures will exceed  $150^\circ\text{C}$  when overtemperature protection is active. Continuous operation above the specified maximum operating junction temperature may impair device reliability.

**Note 4:** Static current, switches not switching. Actual current may be higher due to gate charge losses at the switching frequency.

**Note 5:** The current limit features of this part are intended to protect the IC from short term or intermittent fault conditions. Continuous operation above the maximum specified pin current rating may result in device degradation over time.

## TYPICAL PERFORMANCE CHARACTERISTICS $T_A = 25^\circ\text{C}$ , unless otherwise noted.

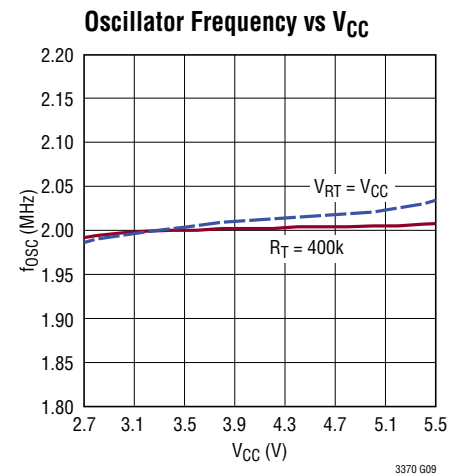
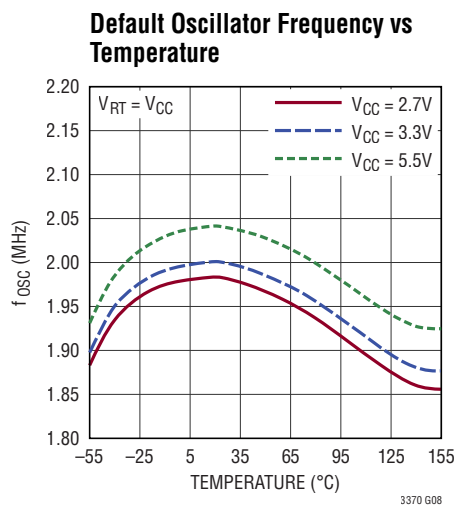
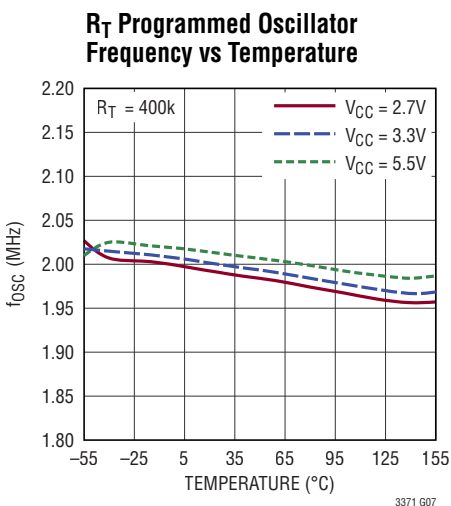
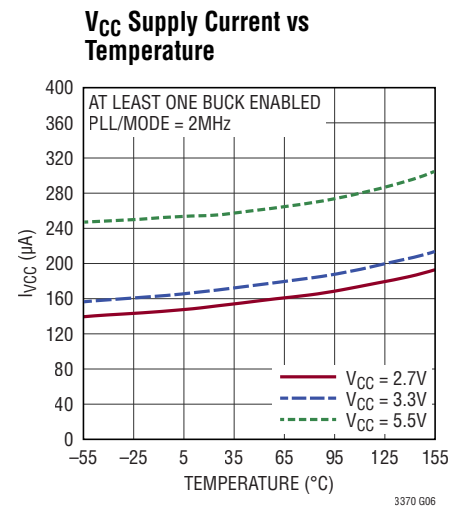
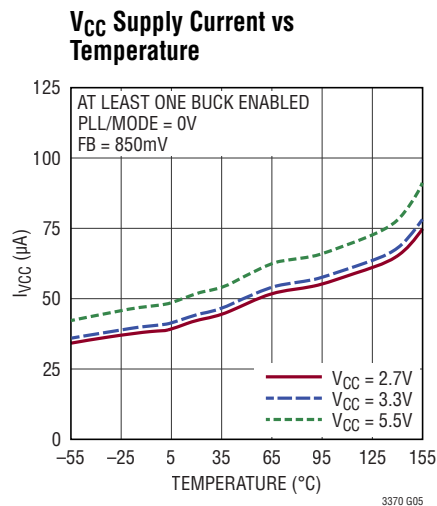
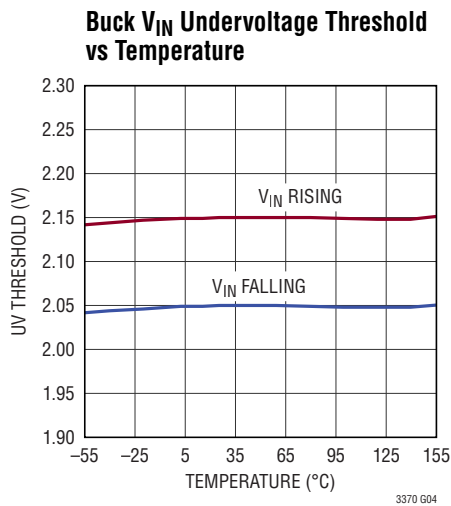
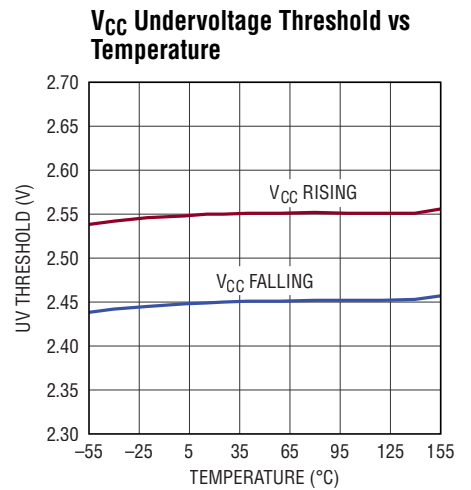
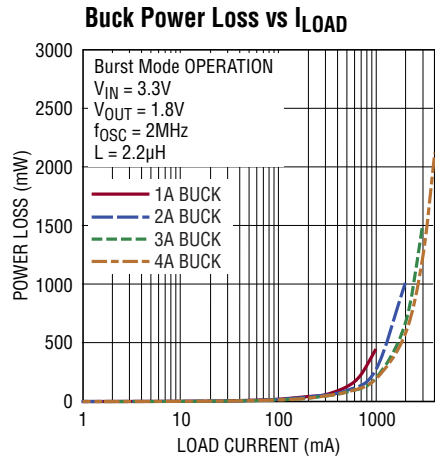
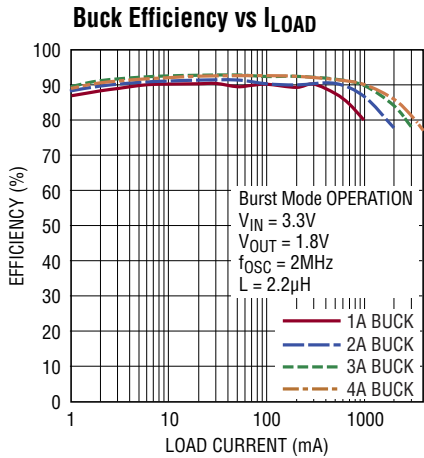

**TYPICAL PERFORMANCE CHARACTERISTICS**  $T_A = 25^\circ\text{C}$ , unless otherwise noted.

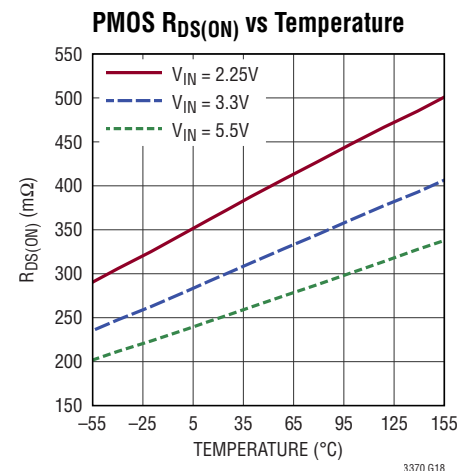
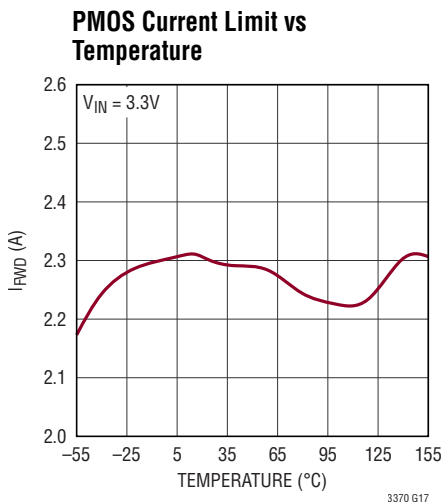
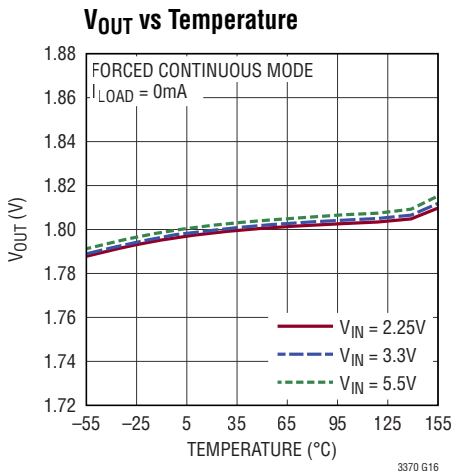
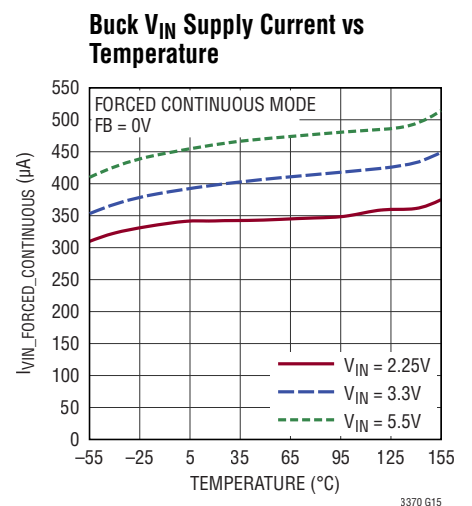
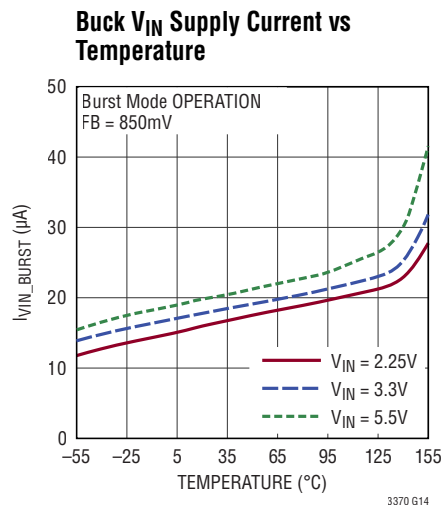
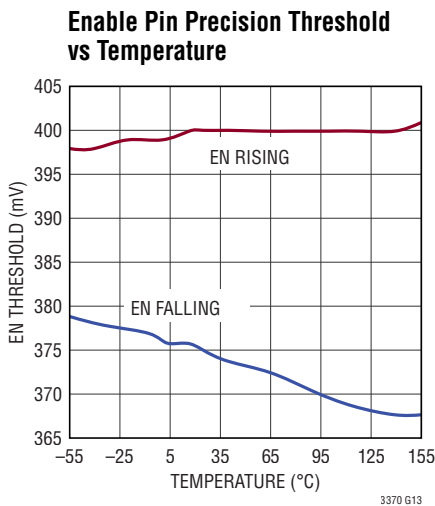
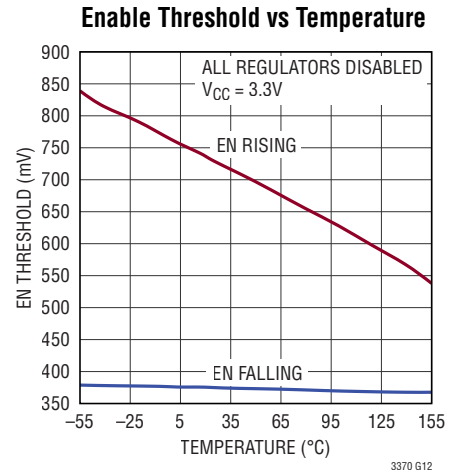
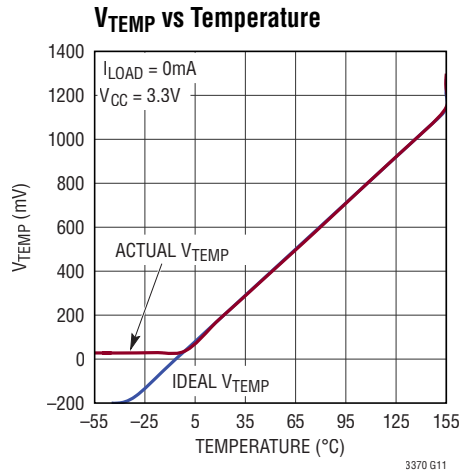
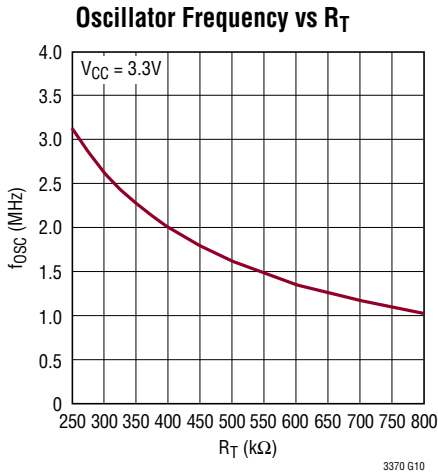

## TYPICAL PERFORMANCE CHARACTERISTICS $T_A = 25^\circ\text{C}$ , unless otherwise noted.

### NMOS $R_{DS(ON)}$ vs Temperature

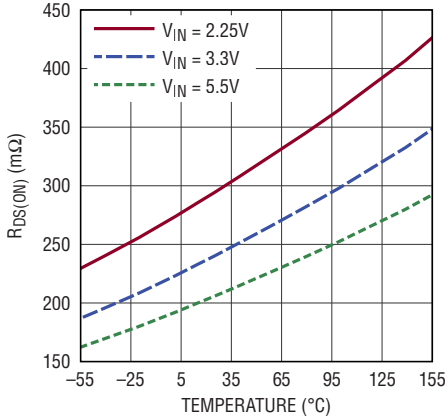

3370 G19

### 1A Buck Efficiency vs $I_{LOAD}$ , $V_{OUT} = 1.2\text{V}$

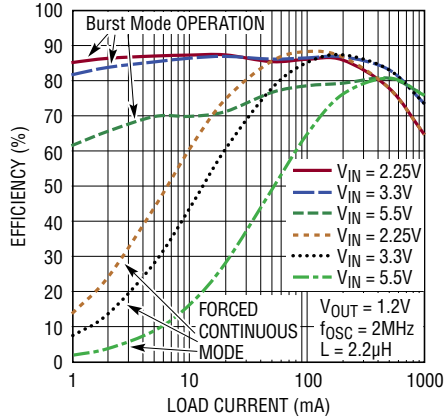

3370 G20

### 1A Buck Power Loss vs $I_{LOAD}$ , $V_{OUT} = 1.2\text{V}$

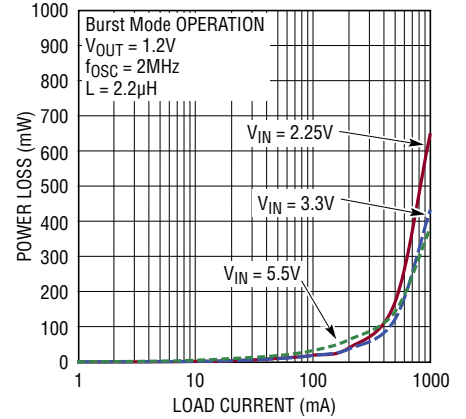

3370 G21

### 1A Buck Efficiency vs $I_{LOAD}$ , $V_{OUT} = 1.8\text{V}$

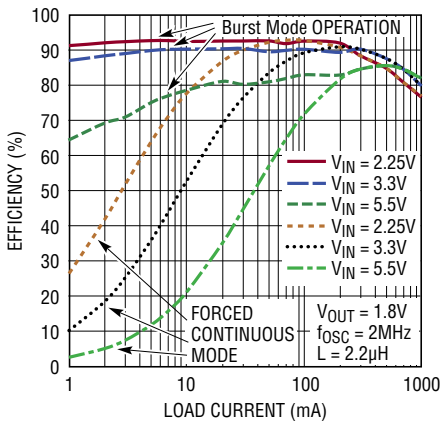

3370 G22

### 1A Buck Power Loss vs $I_{LOAD}$ , $V_{OUT} = 1.8\text{V}$

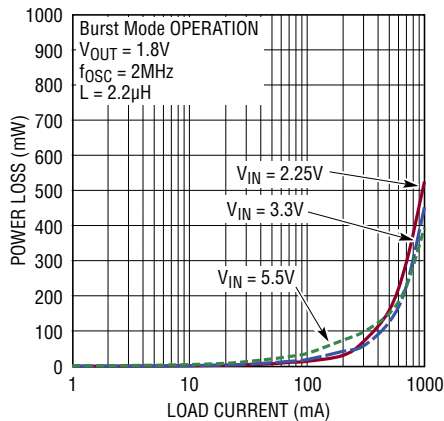

3370 G23

### 1A Buck Efficiency vs $I_{LOAD}$ , $V_{OUT} = 2.5\text{V}$

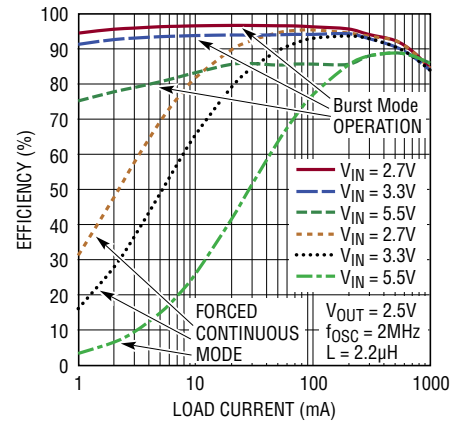

3370 G24

### 1A Buck Power Loss vs $I_{LOAD}$ , $V_{OUT} = 2.5\text{V}$

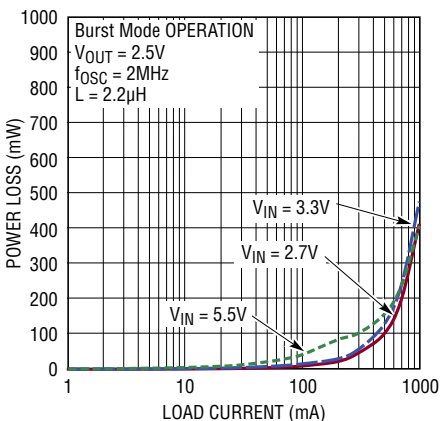

3370 G25

### 1A Buck Efficiency vs $I_{LOAD}$ , $V_{OUT} = 3.3\text{V}$

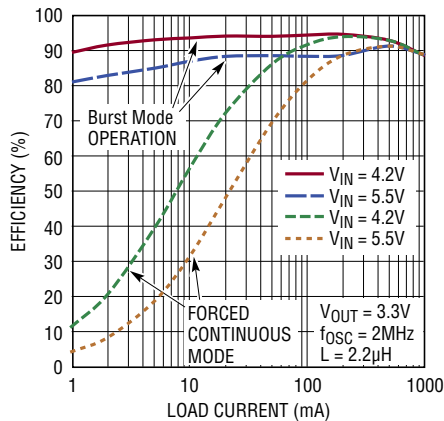

3370 G26

### 1A Buck Power Loss vs $I_{LOAD}$ , $V_{OUT} = 3.3\text{V}$

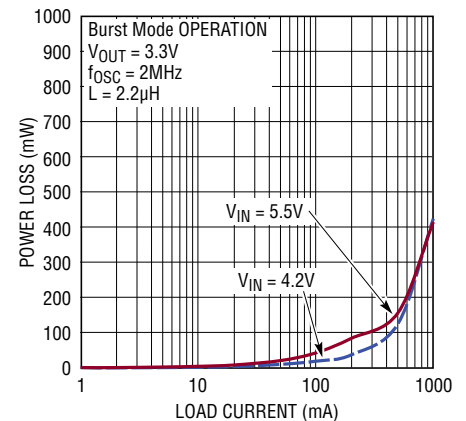

3370 G27

**TYPICAL PERFORMANCE CHARACTERISTICS**  $T_A = 25^\circ\text{C}$ , unless otherwise noted.

**2A Buck Efficiency vs  $I_{LOAD}$ ,  $V_{OUT} = 1.8\text{V}$**

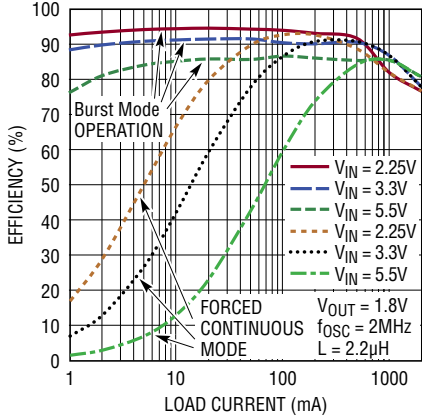

3370 G28

**2A Buck Efficiency vs  $I_{LOAD}$ ,  $V_{OUT} = 2.5\text{V}$**

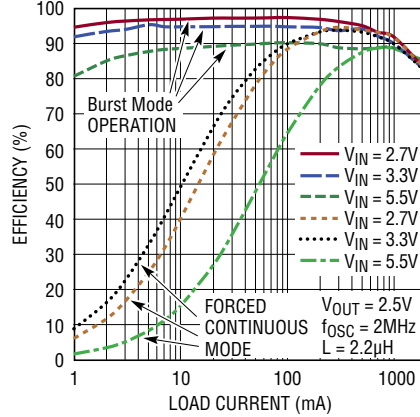

3370 G29

**3A Buck Efficiency vs  $I_{LOAD}$ ,  $V_{OUT} = 1.8\text{V}$**

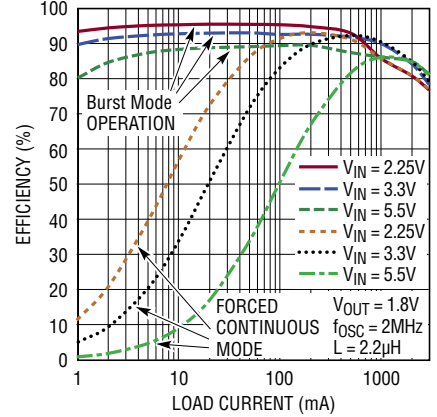

3370 G30

**3A Buck Efficiency vs  $I_{LOAD}$ ,  $V_{OUT} = 2.5\text{V}$**

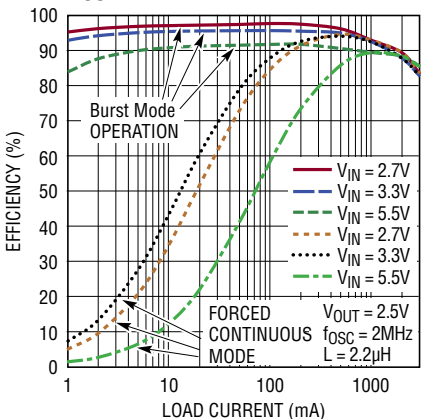

3370 G31

**4A Buck Efficiency vs  $I_{LOAD}$ ,  $V_{OUT} = 1.8\text{V}$**

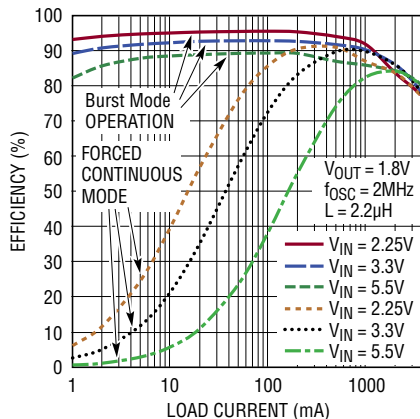

3370 G32

**4A Buck Efficiency vs  $I_{LOAD}$ ,  $V_{OUT} = 2.5\text{V}$**

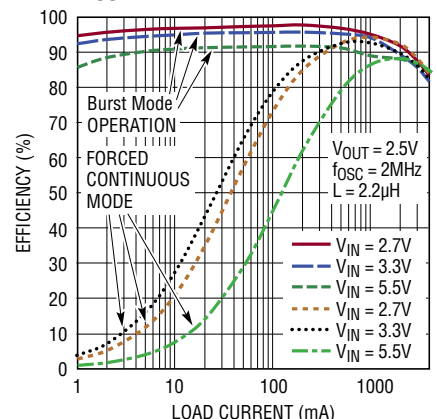

3370 G33

**1A Buck Efficiency vs  $I_{LOAD}$  (Across Operating Frequency)**

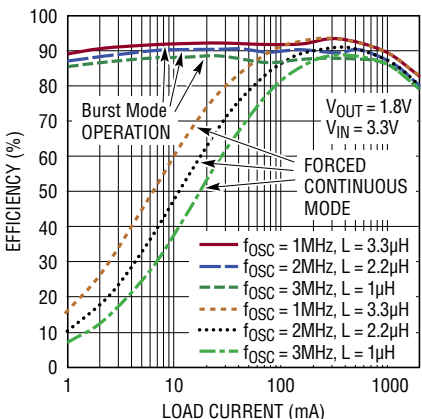

3370 G34

**1A Buck Efficiency vs Frequency (Forced Continuous Mode)**

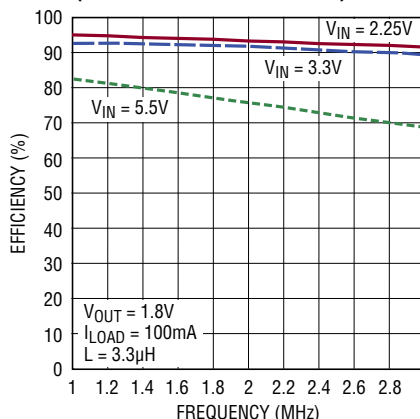

3370 G35

**1A Buck Efficiency vs Frequency (Forced Continuous Mode)**

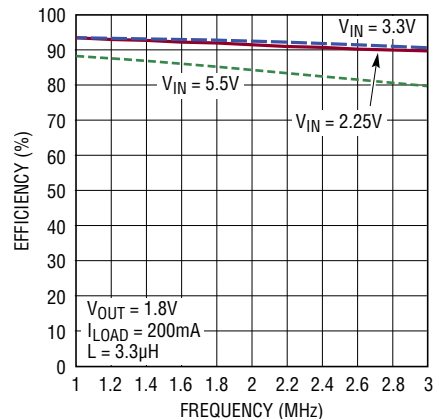

3370 G36

## TYPICAL PERFORMANCE CHARACTERISTICS $T_A = 25^\circ\text{C}$ , unless otherwise noted.

**1A Buck Efficiency vs Frequency (Forced Continuous Mode)**

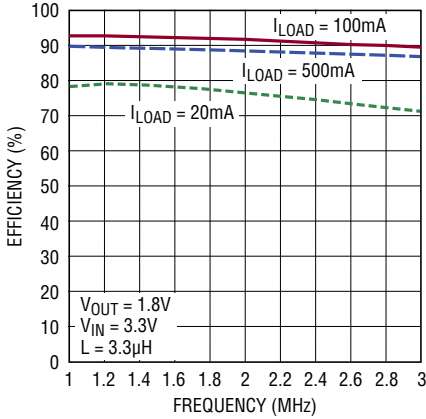

**1A Buck Regulator Load Regulation (Forced Continuous Mode)**

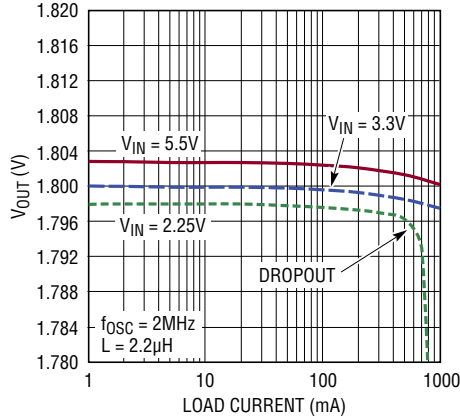

**4A Buck Regulator Load Regulation (Forced Continuous Mode)**

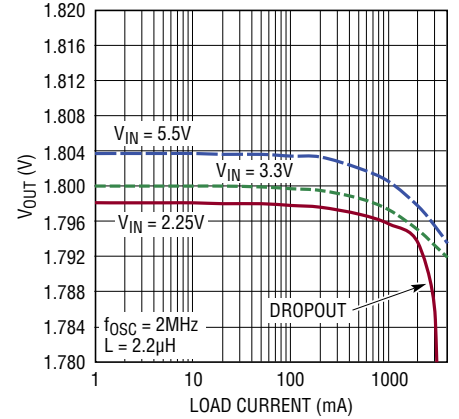

**1A Buck Regulator Line Regulation (Forced Continuous Mode)**

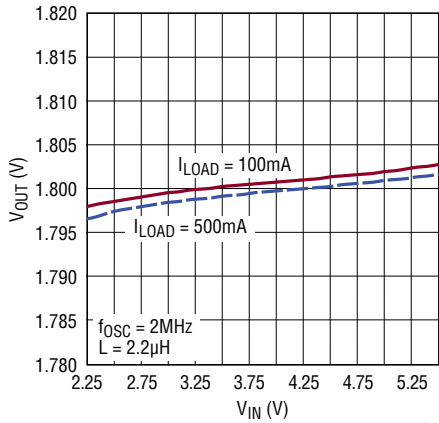

**1A Buck Regulator No-Load Start-Up Transient (Burst Mode Operation)**

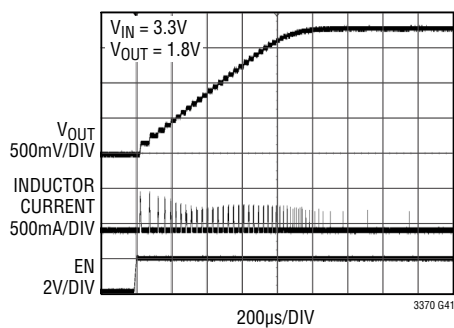

**1A Buck Regulator No-Load Start-Up Transient (Forced Continuous Mode)**

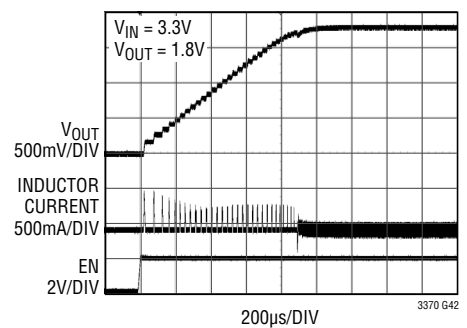

**4A Buck Regulator No-Load Start-Up Transient (Burst Mode Operation)**

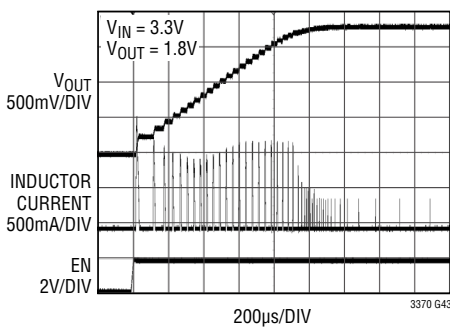

**4A Buck Regulator No-Load Start-Up Transient (Forced Continuous Mode)**

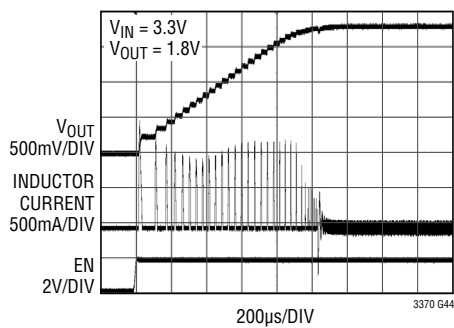

**1A Buck Regulator Transient Response (Burst Mode Operation)**

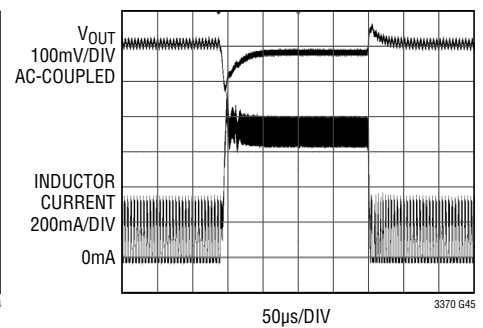

LOAD STEP = 100mA TO 700mA  
 $V_{IN} = 3.3\text{V}$   
 $V_{OUT} = 1.8\text{V}$

## TYPICAL PERFORMANCE CHARACTERISTICS $T_A = 25^\circ\text{C}$ , unless otherwise noted.

**1A Buck Regulator Transient Response (Forced Continuous Mode)**

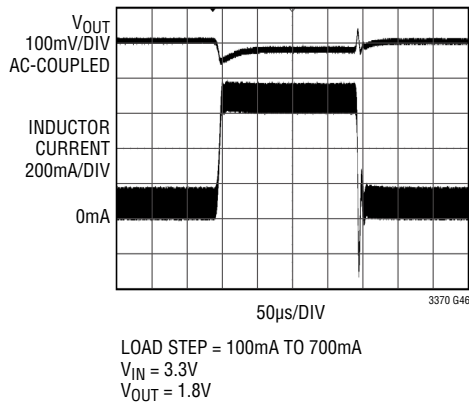

**4A Buck Regulator Transient Response (Burst Mode Operation)**

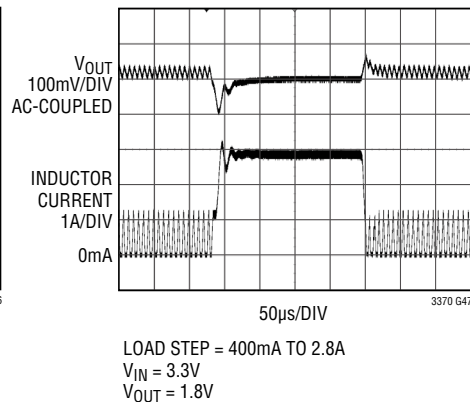

**4A Buck Regulator Transient Response (Forced Continuous Mode)**

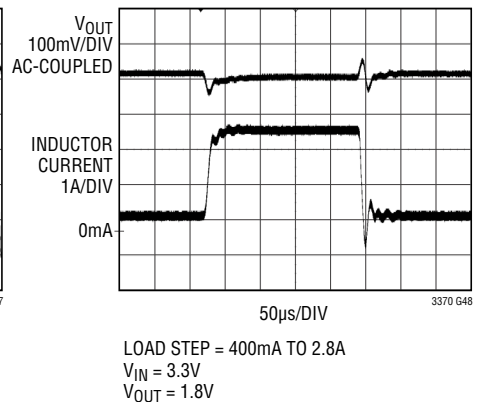

## PIN FUNCTIONS

**$V_{INA}$  (Pin 1):** Power Stage A Input Supply. Bypass to GND with a  $10\mu\text{F}$  or larger ceramic capacitor.

**SWA (Pin 2):** Power Stage A Switch Node. External inductor connects to this pin.

**SWB (Pin 3):** Power Stage B Switch Node. External inductor connects to this pin.

**$V_{INB}$  (Pin 4):** Power Stage B Input Supply. Bypass to GND with a  $10\mu\text{F}$  or larger ceramic capacitor.

**$V_{INC}$  (Pin 5):** Power Stage C Input Supply. Bypass to GND with a  $10\mu\text{F}$  or larger ceramic capacitor.

**SWC (Pin 6):** Power Stage C Switch Node. External inductor connects to this pin.

**SWD (Pin 7):** Power Stage D Switch Node. External inductor connects to this pin.

**$V_{IND}$  (Pin 8):** Power Stage D Input Supply. Bypass to GND with a  $10\mu\text{F}$  or larger ceramic capacitor.

**FB2 (Pin 9):** Buck Regulator 2 Feedback Pin. Receives feedback by a resistor divider connected across the output. In configurations where Buck 2 is not used, FB2 should be tied to ground.

**EN2 (Pin 10):** Buck Regulator 2 Enable Input. Active high. In configurations where Buck 2 is not used, tie EN2 to ground. Do not float.

**C1 (Pin 11):** Configuration Control Input Bit. With C2 and C3, C1 configures the Buck output current power stage combinations. C1 should either be tied to  $V_{CC}$  or ground. Do not float.

**C2 (Pin 12):** Configuration Control Input Bit. With C1 and C3, C2 configures the Buck output current power stage combinations. C2 should either be tied to  $V_{CC}$  or ground. Do not float.

**C3 (Pin 13):** Configuration Control Input Bit. With C1 and C2, C3 configures the Buck output current power stage combinations. C3 should either be tied to  $V_{CC}$  or ground. Do not float.

**PGOODALL (Pin 14):** PGOOD Status Pin (Active Low). Open-drain output. When the regulated output voltage of any enabled switching regulator is below its PGOOD threshold level, this pin is driven LOW. This level is 98% of the programmed output value for Buck 1 and 95% of

## PIN FUNCTIONS

the programmed output value for Bucks 2-4. When all buck regulators are disabled PGOODALL is driven LOW.

**EN3 (Pin 15):** Buck Regulator 3 Enable Input. Active high. In configurations where Buck 3 is not used, tie EN3 to ground. Do not float.

**FB3 (Pin 16):** Buck Regulator 3 Feedback Pin. Receives feedback by a resistor divider connected across the output. In configurations where Buck 3 is not used, FB3 should be tied to ground.

**V<sub>INE</sub> (Pin 17):** Power Stage E Input Supply. Bypass to GND with a 10 $\mu$ F or larger ceramic capacitor.

**SWE (Pin 18):** Power Stage E Switch Node. External inductor connects to this pin.

**SWF (Pin 19):** Power Stage F Switch Node. External inductor connects to this pin.

**V<sub>INF</sub> (Pin 20):** Power Stage F Input Supply. Bypass to GND with a 10 $\mu$ F or larger ceramic capacitor.

**V<sub>ING</sub> (Pin 21):** Power Stage G Input Supply. Bypass to GND with a 10 $\mu$ F or larger ceramic capacitor.

**SWG (Pin 22):** Power Stage G Switch Node. External inductor connects to this pin.

**SWH (Pin 23):** Power Stage H Switch Node. External inductor connects to this pin.

**V<sub>INH</sub> (Pin 24):** Power Stage H Input Supply. Bypass to GND with a 10 $\mu$ F or larger ceramic capacitor.

**FB4 (Pin 25):** Buck Regulator 4 Feedback Pin. Receives feedback by a resistor divider connected across the output.

**EN4 (Pin 26):** Buck Regulator 4 Enable Input. Active high. Do not float.

**RT (Pin 27):** Oscillator Frequency Pin. This pin provides two modes of setting the switching frequency. Connecting a resistor from RT to ground sets the switching frequency based on the resistor value. If RT is tied to V<sub>CC</sub> the internal 2MHz oscillator is used. Do not float.

**PLL/MODE (Pin 28):** Oscillator Synchronization and Buck Mode Select Pin. Driving PLL/MODE with an external clock signal synchronizes all switches to the applied frequency, and the buck converters operate in forced continuous mode. The slope compensation is automatically adapted to the external clock frequency. The absence of an external clock signal enables the frequency programmed by the RT pin. When not synchronizing to an external clock this input determines how the LTC3370 operates at light loads. Pulling this pin to ground selects Burst Mode operation. Tying this pin to V<sub>CC</sub> invokes forced continuous mode operation. Do not float.

**V<sub>CC</sub> (Pin 29):** Internal Bias Supply. Bypass to GND with a 10 $\mu$ F or larger ceramic capacitor.

**TEMP (Pin 30):** Temperature Indication Pin. TEMP outputs a voltage of 220mV (typical) at 25°C. The TEMP voltage increases by 7mV/°C (typical) at higher temperatures giving an external indication of the LTC3370 internal die temperature.

**EN1 (Pin 31):** Buck Regulator 1 Enable Input. Active high. Do not float.

**FB1 (Pin 32):** Buck Regulator 1 Feedback Pin. Receives feedback by a resistor divider connected across the output.

**GND (Exposed Pad Pin 33):** Ground. The exposed pad should be connected to a continuous ground plane on the printed circuit board directly under the LTC3370.

# BLOCK DIAGRAM

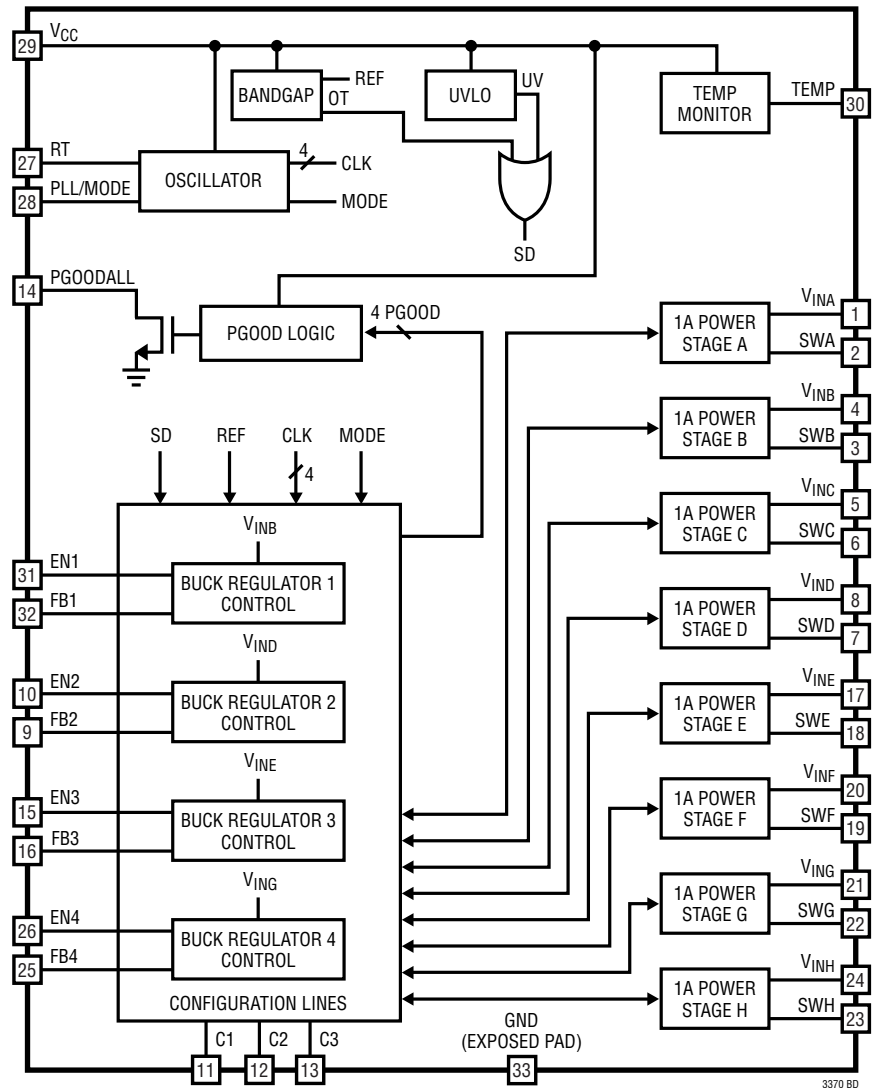

C3	C2	C1	BUCK1	BUCK2	BUCK3	BUCK4
0	0	0	2A	2A	2A	2A
0	0	1	3A	1A	2A	2A
0	1	0	3A	1A	1A	3A
0	1	1	4A	1A	1A	2A
1	0	0	3A	2A	-	3A
1	0	1	4A	-	2A	2A
1	1	0	4A	-	1A	3A
1	1	1	4A	-	-	4A

3370 BD

## OPERATION

### Buck Switching Regulators

The LTC3370 contains eight monolithic 1A synchronous buck switching channels. These are controlled by up to four current mode regulator controllers. All of the switching regulators are internally compensated and need only external feedback resistors to set the output voltage. The switching regulators offer two operating modes: Burst Mode operation (PLL/MODE = LOW) for higher efficiency at light loads and forced continuous PWM mode (PLL/MODE = HIGH or switching) for lower noise at light loads. In Burst Mode operation at light loads, the output capacitor is charged to a voltage slightly higher than its regulation point. The regulator then goes into a sleep state, during which time the output capacitor provides the load current. In sleep most of the regulator's circuitry is powered down, helping conserve input power. When the output capacitor droops below its programmed value, the circuitry is powered on and another burst cycle begins. The sleep time decreases as load current increases. In Burst Mode operation, the regulator bursts at light loads whereas at higher loads it operates at constant frequency PWM mode operation. In forced continuous mode, the oscillator runs continuously and the buck switch currents are allowed to reverse under very light load conditions to maintain regulation. This mode allows the buck to run at a fixed frequency with minimal output ripple.

Each buck switching regulator can operate at an independent  $V_{IN}$  voltage and has its own FB and EN pin to maximize flexibility. The enable pins have two different enable threshold voltages that depend on the operating state of the LTC3370. With all regulators disabled, the enable pin threshold is set to 730mV (typical). Once any regulator is enabled, the enable pin thresholds of the remaining regulators are set to a bandgap-based 400mV and the EN pins are each monitored by a precision comparator. This precision EN threshold may be used to provide event-based sequencing via feedback from other previously enabled regulators. All buck regulators have forward and reverse-current limiting, soft-start to limit inrush current during start-up, and short-circuit protection.

The buck switching regulators are phased in 90° steps to reduce noise and input ripple. The phase step determines the fixed edge of the switching sequence, which is when the PMOS turns on. The PMOS off (NMOS on) phase is subject to the duty cycle demanded by the regulator. Buck 1 is set to 0°, Buck 2 is set to 90°, Buck 3 is set to 270°, and Buck 4 is set to 180°. In shutdown all SW nodes are high impedance. The buck regulator enable pins may be tied to  $V_{OUT}$  voltages through a resistor divider, to program power-up sequencing.

The buck switching regulators feature a controlled shutdown scheme where the inductor current ramps down to zero through the NMOS switch. If any event causes the buck regulator to shut down (EN = LOW, OT,  $V_{INA-H}$  or  $V_{CC}$  UVLO) the NMOS switch turns on until the inductor current reaches 0mA (typical). Then, the switch pin becomes Hi-Z.

### Buck Regulators with Combined Power Stages

Up to four adjacent buck regulators may be combined in a master-slave configuration by setting the configuration via the C1, C2, and C3 pins. These pins should either be tied to ground or pin strapped to  $V_{CC}$  in accordance with the desired configuration code (Table 1). Any combined SW pins must be tied together, as must any of the combined  $V_{IN}$  pins. EN1 and FB1 are utilized by Buck 1, EN2 and FB2 by Buck 2, EN3 and FB3 by Buck 3, and EN4 and FB4 by Buck 4. If any buck is not used or is not available in the desired configuration, then the associated FB and EN pins must be tied to ground.

Any available combination of 2, 3, or 4 adjacent Buck regulators serve to provide up to either 2A, 3A, or 4A of average output load current. For example, code 110 (C3C2C1) configures Buck 1 to operate as a 4A regulator through  $V_{IN}/SW$  pairs A, B, C, and D, while Buck 2 is disabled, Buck 3 operates as a 1A regulator through  $V_{IN}/SW$  pair E, and Buck 4 operates as a 3A regulator through  $V_{IN}/SW$  pairs F, G, and H.

## OPERATION

**Table 1. Master Slave Program Combinations (Each Letter Corresponds to a  $V_{IN}$  and SW Pair)**

PROGRAM CODE C3C2C1	BUCK 1	BUCK 2	BUCK 3	BUCK 4
000	AB	CD	EF	GH
001	ABC	D	EF	GH
010	ABC	D	E	FGH
011	ABCH	D	E	FG
100	ABC	DE	Not Used	FGH
101	ABCD	Not Used	EF	GH
110	ABCD	Not Used	E	FGH
111	ABCD	Not Used	Not Used	EFGH

### Power Failure Reporting Via PGOODALL Pin

Power failure conditions are reported back by the PGOODALL pin. Each buck switching regulator has an internal power good (PGOOD) signal. When the regulated output voltage of an enabled switcher falls below 98% for Buck regulator 1 or 95% for Buck regulators 2-4 of its programmed value, the PGOOD signal is pulled low. If any PGOOD signal stays low for greater than 100 $\mu$ s, then the PGOODALL pin is pulled low, indicating to a microprocessor that a power failure fault has occurred. The 100 $\mu$ s filter time prevents the pin from being pulled low due to a transient. The PGOOD signal has a 0.3% hysteresis such that when the regulated output voltage of an enabled switcher rises above 98.3% or 95.3%, respectively, of its programmed value, the PGOOD signal transitions high.

### Temperature Monitoring and Overtemperature Protection

To prevent thermal damage to the LTC3370 and its surrounding components, the LTC3370 incorporates an overtemperature (OT) function. When the LTC3370 die temperature reaches 170°C (typical) all enabled buck switching regulators are shut down and remain in shutdown until the die temperature falls to 160°C (typical).

The temperature may be read back by the user by sampling the TEMP pin analog voltage. The temperature, T, indicated by the TEMP pin voltage is given by:

$$T = \frac{V_{TEMP} - 45mV}{7mV} \cdot 1^{\circ}C \quad (1)$$

If none of the buck switching regulators are enabled, then the temperature monitor is also shut down to further reduce quiescent current.

### Programming the Operating Frequency

Selection of the operating frequency is a trade-off between efficiency and component size. High frequency operation allows the use of smaller inductor and capacitor values. Operation at lower frequencies improves efficiency by reducing internal gate charge losses but requires larger inductance values and/or capacitance to maintain low output voltage ripple.

The operating frequency for all of the LTC3370 regulators is determined by an external resistor that is connected between the RT pin and ground. The operating frequency can be calculated using the following equation:

$$f_{OSC} = \frac{8 \cdot 10^{11} \cdot \Omega Hz}{R_T} \quad (2)$$

While the LTC3370 is designed to function with operating frequencies between 1MHz and 3MHz, it has safety clamps that will prevent the oscillator from running faster than 4MHz (typical) or slower than 250kHz (typical). Tying the RT pin to  $V_{CC}$  sets the oscillator to the default internal operating frequency of 2MHz (typical).

The LTC3370's internal oscillator can be synchronized through an internal PLL circuit to an external frequency by applying a square wave clock signal to the PLL/MODE pin. During synchronization, the top MOSFET turn-on of Buck regulator 1 is phase locked to the rising edge of the external frequency source. All other buck switching regulators are locked to the appropriate phase of the external frequency source (see Buck Switching Regulators). The synchronization frequency range is 1MHz to 3MHz. A synchronization signal on the PLL/MODE pin will force all active buck switching regulators to operate in forced continuous mode PWM.

## APPLICATIONS INFORMATION

### Buck Switching Regulator Output Voltage and Feedback Network

The output voltage of the buck switching regulators is programmed by a resistor divider connected from the switching regulator's output to its feedback pin and is given by  $V_{OUT} = V_{FB}(1 + R2/R1)$  as shown in Figure 1. Typical values for R1 range from 40k $\Omega$  to 1M $\Omega$ . The buck regulator transient response may improve with optional capacitor,  $C_{FF}$ , that helps cancel the pole created by the feedback resistors and the input capacitance of the FB pin. Experimentation with capacitor values between 2pF and 22pF may improve transient response.

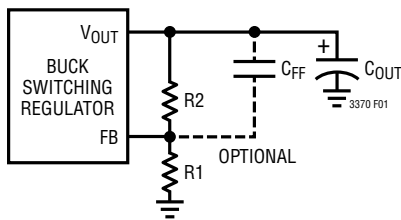

Figure 1. Feedback Components

### Buck Regulators

All four buck regulators are designed to be used with inductors ranging from 1 $\mu$ H to 3.3 $\mu$ H depending on the lowest switching frequency at which the buck regulator must operate. When operating at 1MHz a 3.3 $\mu$ H inductor should be used, while at 3MHz a 1 $\mu$ H inductor may be used, or a higher value inductor may be used if reduced current ripple is desired. Table 2 shows some recommended inductors for the buck regulators. The bucks are compensated to operate across the range of possible  $V_{IN}$  and  $V_{OUT}$  voltages when the appropriate inductance is used for the desired switching frequency.

The input supply should be decoupled with a 10 $\mu$ F capacitor while the output should be decoupled with a 22 $\mu$ F capacitor. Refer to the Capacitor Selection section for details on selecting a proper capacitor.

### Combined Buck Power Stages

The LTC3370 has eight power stages that can handle average load currents of 1A each. These power stages may be combined in any one of eight possible combinations, via

the C1, C2, and C3 pins (see Table 1). Tables 3, 4, and 5 show recommended inductors for the combined power stage configurations.

The input supply should be decoupled with a 22 $\mu$ F capacitor while the output should be decoupled with a 47 $\mu$ F capacitor for a 2A combined buck regulator. Likewise for 3A and 4A configurations the input and output capacitance must be scaled up to account for the increased load. Refer to the Capacitor Selection section for details on selecting a proper capacitor.

In some cases it may be beneficial to use more power stages than needed to achieve increased efficiency of the active regulators. In general the efficiency will improve by adding stages for any regulator running close to what the rated load current would be without the additional stage. For example, if the application requires a 1A regulator that supplies close to 1A at a high duty cycle, a 3A regulator that only peaks at 3A but averages a lower current, and a 2A regulator that runs at 1.5A at a high duty cycle, better efficiency may be achieved by using the 3A, 3A, 2A configuration.

### Input and Output Decoupling Capacitor Selection

The LTC3370 has individual input supply pins for each buck power stage and a separate  $V_{CC}$  pin that supplies power to all top level control and logic. Each of these pins must be decoupled with low ESR capacitors to GND. These capacitors must be placed as close to the pins as possible. Ceramic dielectric capacitors are a good compromise between high dielectric constant and stability versus temperature and DC bias. Note that the capacitance of a capacitor deteriorates at higher DC bias. It is important to consult manufacturer data sheets and obtain the true capacitance of a capacitor at the DC bias voltage that it will be operated at. For this reason, avoid the use of Y5V dielectric capacitors. The X5R/X7R dielectric capacitors offer good overall performance.

The input supply voltage Pins 1, 4, 5, 8, 17, 20, 21, 24 and 29 all need to be decoupled with at least 10 $\mu$ F capacitors. If power stages are combined the supplies should be shorted with as short of a trace as possible, and the decoupling capacitor should be scaled accordingly.

## APPLICATIONS INFORMATION

**Table 2. Recommended Inductors for 1A Buck Regulators**

PART NUMBER	L ( $\mu$ H)	MAX I <sub>DC</sub> (A)	MAX DCR (m $\Omega$ )	SIZE IN mm (L $\times$ W $\times$ H)	MANUFACTURER
IHLP1212ABER1R0M-11	1.0	3	38	3 $\times$ 3.6 $\times$ 1.2	Vishay
1239AS-H-1R0N	1	2.5	65	2.5 $\times$ 2.0 $\times$ 1.2	Toko
XFL4020-222ME	2.2	3.5	23.5	4 $\times$ 4 $\times$ 2.1	CoilCraft
1277AS-H-2R2N	2.2	2.6	84	3.2 $\times$ 2.5 $\times$ 1.2	Toko
IHLP1212BZER2R2M-11	2.2	3	46	3 $\times$ 3.6 $\times$ 1.2	Vishay
XFL4020-332ME	3.3	2.8	38.3	4 $\times$ 4 $\times$ 2.1	CoilCraft
IHLP1212BZER3R3M-11	3.3	2.7	61	3 $\times$ 3.6 $\times$ 1.2	Vishay

**Table 3. Recommended Inductors for 2A Buck Regulators**

PART NUMBER	L ( $\mu$ H)	MAX I <sub>DC</sub> (A)	MAX DCR (m $\Omega$ )	SIZE IN mm (L $\times$ W $\times$ H)	MANUFACTURER
XFL4020-102ME	1.0	5.1	11.9	4 $\times$ 4 $\times$ 2.1	CoilCraft
74437324010	1	5	27	4.45 $\times$ 4.06 $\times$ 1.8	Würth Elektronik
XAL4020-222ME	2.2	5.6	38.7	4 $\times$ 4 $\times$ 2.1	CoilCraft
FDV0530-2R2M	2.2	5.3	15.5	6.2 $\times$ 5.8 $\times$ 3	Toko
IHLP2020BZER2R2M-11	2.2	5	37.7	5.49 $\times$ 5.18 $\times$ 2	Vishay
XAL4030-332ME	3.3	5.5	28.6	4 $\times$ 4 $\times$ 3.1	CoilCraft
FDV0530-3R3M	3.3	4.1	34.1	6.2 $\times$ 5.8 $\times$ 3	Toko

**Table 4. Recommended Inductors for 3A Buck Regulators**

PART NUMBER	L ( $\mu$ H)	MAX I <sub>DC</sub> (A)	MAX DCR (m $\Omega$ )	SIZE IN mm (L $\times$ W $\times$ H)	MANUFACTURER
XAL4020-102ME	1.0	8.7	14.6	4 $\times$ 4 $\times$ 2.1	CoilCraft
FDV0530-1R0M	1	8.4	11.2	6.2 $\times$ 5.8 $\times$ 3	Toko
XAL5030-222ME	2.2	9.2	14.5	5.28 $\times$ 5.48 $\times$ 3.1	CoilCraft
IHLP2525CZER2R2M-01	2.2	8	20	6.86 $\times$ 6.47 $\times$ 3	Vishay
74437346022	2.2	6.5	20	7.3 $\times$ 6.6 $\times$ 2.8	Würth Elektronik
XAL5030-332ME	3.3	8.7	23.3	5.28 $\times$ 5.48 $\times$ 3.1	CoilCraft
SPM6530T-3R3M	3.3	7.3	27	7.1 $\times$ 6.5 $\times$ 3	TDK

**Table 5. Recommended Inductors for 4A Buck Regulators**

PART NUMBER	L ( $\mu$ H)	MAX I <sub>DC</sub> (A)	MAX DCR (m $\Omega$ )	SIZE IN mm (L $\times$ W $\times$ H)	MANUFACTURER
XAL5030-122ME	1.2	12.5	9.4	5.28 $\times$ 5.48 $\times$ 3.1	CoilCraft
SPM6530T-1R0M120	1	14.1	7.81	7.1 $\times$ 6.5 $\times$ 3	TDK
XAL5030-222ME	2.2	9.2	14.5	5.28 $\times$ 5.48 $\times$ 3.1	CoilCraft
SPM6530T-2R2M	2.2	8.4	19	7.1 $\times$ 6.5 $\times$ 3	TDK
IHLP2525EZER2R2M-01	2.2	13.6	20.9	6.86 $\times$ 6.47 $\times$ 5	Vishay
XAL6030-332ME	3.3	8	20.81	6.36 $\times$ 6.56 $\times$ 3.1	CoilCraft
FDVE1040-3R3M	3.3	9.8	10.1	11.2 $\times$ 10 $\times$ 4	Toko

## APPLICATIONS INFORMATION

### PCB Considerations

When laying out the printed circuit board, the following list should be followed to ensure proper operation of the LTC3370:

1. The exposed pad of the package (Pin 33) should connect directly to a large ground plane to minimize thermal and electrical impedance.
2. Each of the input supply pins should have a decoupling capacitor.
3. The connections to the switching regulator input supply pins and their respective decoupling capacitors should be kept as short as possible. The GND side of these capacitors should connect directly to the ground plane of the part. These capacitors provide the AC current to the internal power MOSFETs and their drivers. It is important to minimize inductance from these capacitors to the  $V_{IN}$  pins of the LTC3370.
4. The switching power traces connecting SWA, SWB, SWC, SWD, SWE, SWF, SWG, and SWH to the inductors should be minimized to reduce radiated EMI and parasitic coupling. Due to the large voltage swing of the switching nodes, high input impedance sensitive nodes, such as the feedback nodes, should be kept far away or shielded from the switching nodes or poor performance could result.
5. The GND side of the switching regulator output capacitors should connect directly to the thermal ground plane of the part. Minimize the trace length from the output capacitor to the inductor(s)/pin(s).
6. In a multiple power stage buck regulator application the trace length of switch nodes to the inductor must be kept equal to ensure proper operation.
7. Care should be taken to minimize capacitance on the TEMP pin. If the TEMP voltage must drive more than  $\sim 30\text{pF}$ , then the pin should be isolated with a resistor placed close to the pin of a value between 10k and 100k. Keep in mind that any load on the isolation resistor will create a proportional error.

TYPICAL APPLICATIONS

4 × 2A Quad Buck Application

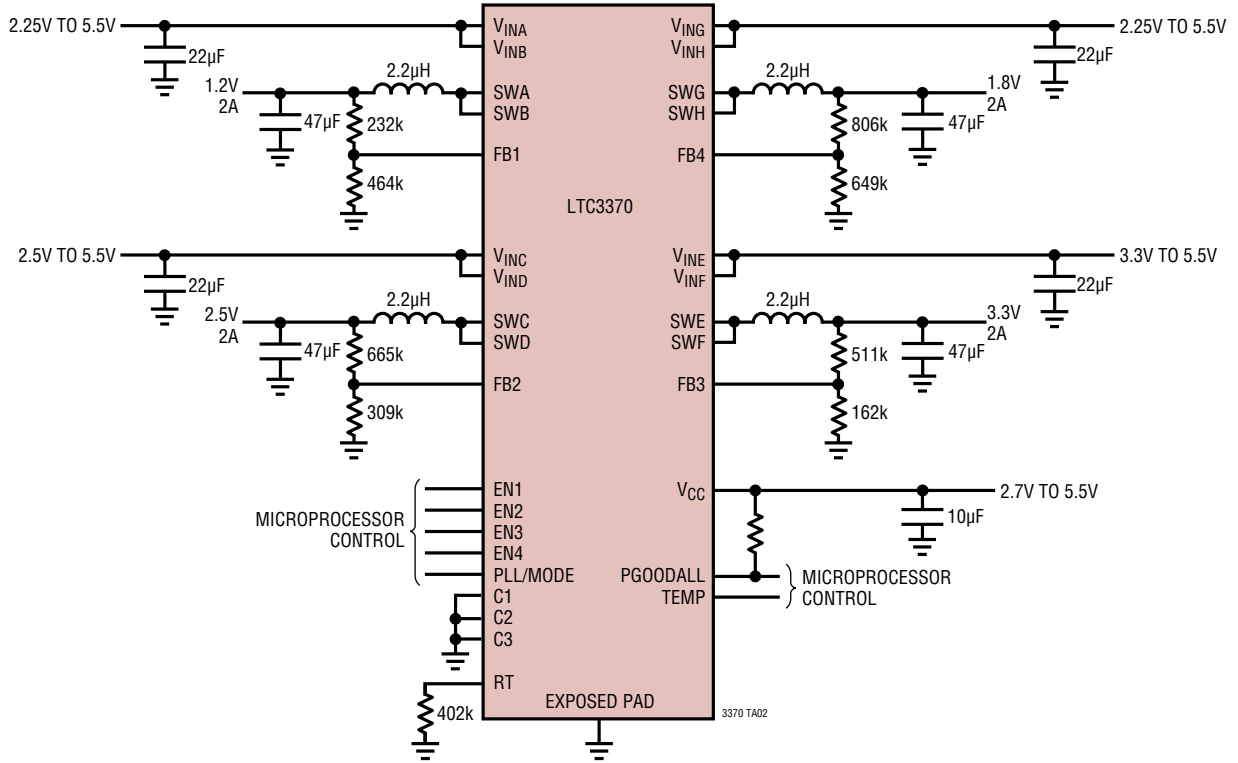

## TYPICAL APPLICATIONS

Buck Regulators with Sequenced Start-Up Driven from a High Voltage Upstream Buck Converter

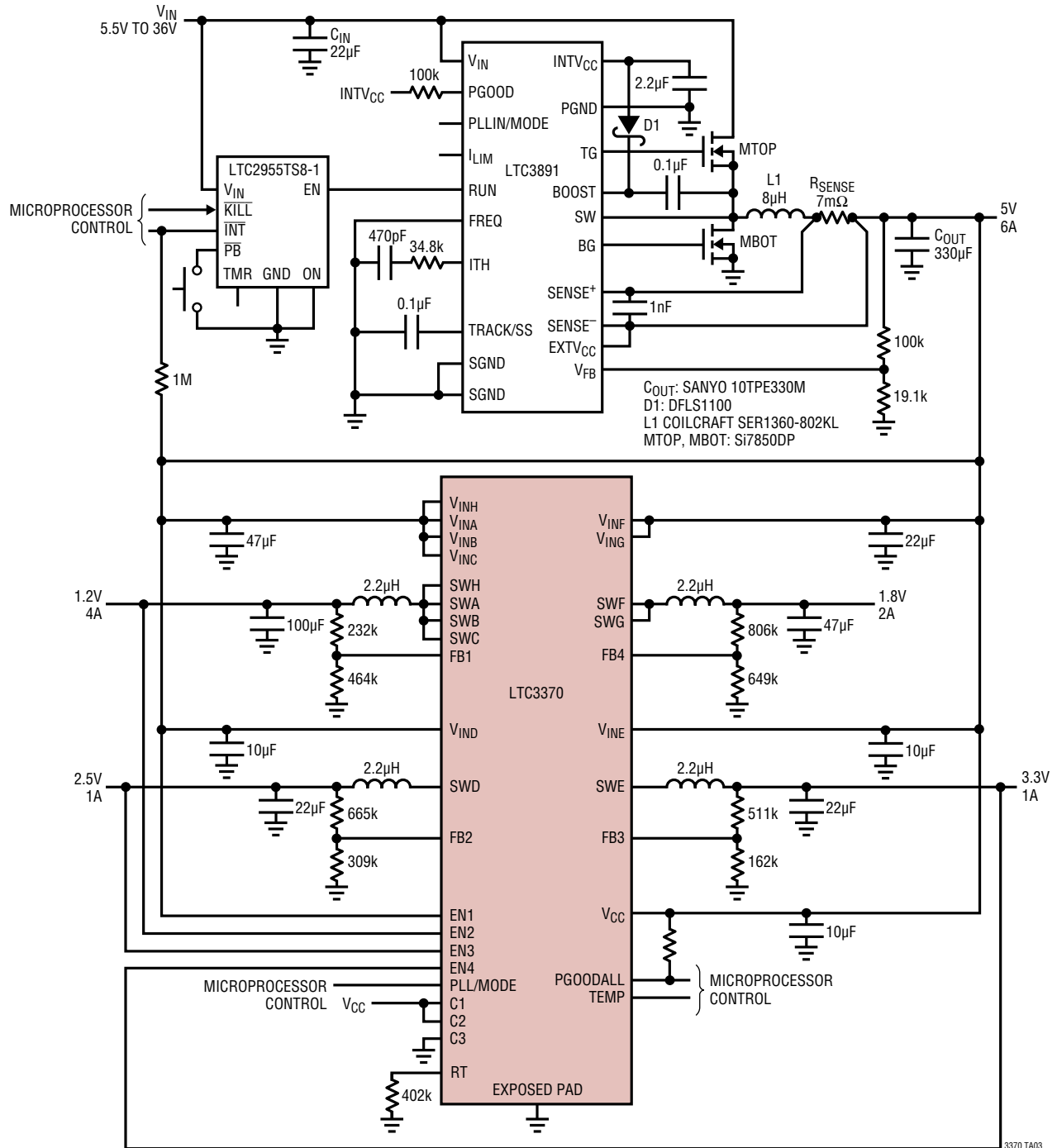

3370 TA03

# TYPICAL APPLICATIONS

Combined Buck Regulators with Common Input Supply

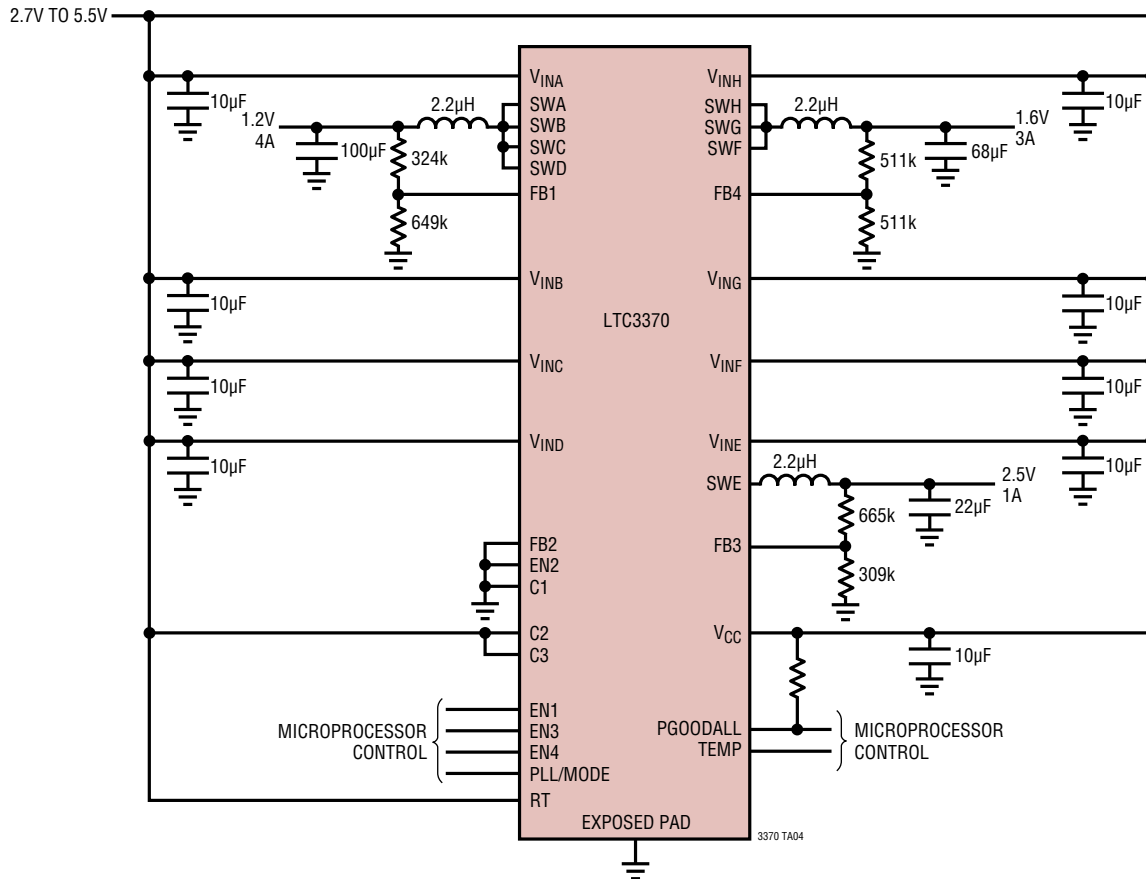



## REVISION HISTORY

REV	DATE	DESCRIPTION	PAGE NUMBER
A	03/16	Changed pin labeling on Typical Application circuit	1
B	09/16	Changed Pin Configuration $T_{JMAX}$ to 150°C	3

## TYPICAL APPLICATION

Combined Bucks with 3MHz Switching Frequency and Sequenced Power Up

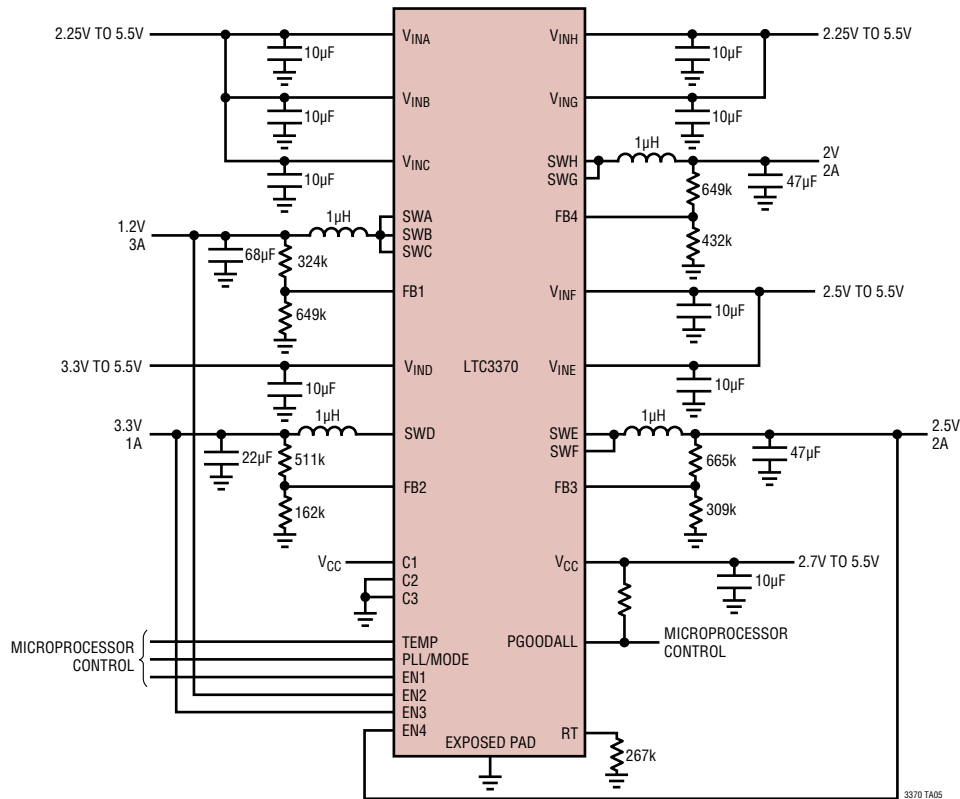

## RELATED PARTS

PART NUMBER	DESCRIPTION	COMMENTS
LTC3589	8-Output Regulator with Sequencing and I <sup>2</sup> C	Triple I <sup>2</sup> C Adjustable High Efficiency Step-Down DC/DC Converters: 1.6A, 1A, 1A. High Efficiency 1.2A Buck-Boost DC/DC Converter, Triple 250mA LDO Regulators. Pushbutton On/Off Control with System Reset, Flexible Pin-Strap Sequencing Operation. I <sup>2</sup> C and Independent Enable Control Pins, Dynamic Voltage Scaling and Slew Rate Control. Selectable 2.25MHz or 1.12MHz Switching Frequency, 8µA Standby Current, 40-Lead (6mm × 6mm × 0.75mm) QFN.
LTC3675	7-Channel Configurable High Power PMIC	Quad Synchronous Buck Regulators (1A, 1A, 500mA, 500mA). Buck DC/DCs Can be Paralleled to Deliver Up to 2× Current with a Single Inductor. 1A Boost, 1A Buck-Boost, 40V LED Driver. 44-Lead (4mm × 7mm × 0.75mm) QFN Package.
LTC3676	8-Channel Power Management Solution for Application Processor	Quad Synchronous Buck Regulators (2.5A, 2.5A, 1.5A, 1.5A). Quad LDO Regulators (300mA, 300mA, 300mA, 25mA). Pushbutton On/Off Control with System Reset. DDR Solution with VTT and VTRR Reference. 40-Lead (6mm × 6mm × 0.75mm) QFN Package.
LTC3375 LTC3374	8-Channel Programmable Configurable 1A DC/DC	8 × 1A Synchronous Buck Regulators. Can Connect Up to Four Power Stages in Parallel to Make a Single Inductor, High Current Output (4A Maximum), 15 Output Configurations Possible, 48-Lead (7mm × 7mm × 0.75mm) QFN Package (LTC3375) 38-Lead (5mm × 7mm × 0.75mm) QFN and TSSOP Packages (LTC3374).
LTC3371	4-Channel Configurable DC/DC with 8 × 1A Power Stages	4 Synchronous Buck Regulators with 8 × 1A Power Stages. Can Connect Up to Four Power Stages in Parallel to Make a Single Inductor, High Current Output (4A Maximum), 8 Output Configurations Possible, Precision R <sub>ST</sub> Monitoring with Windowed Watchdog Timer (CT Programmable), 38-Lead (5mm × 7mm × 0.75mm) QFN and TSSOP Packages.

3370fb

## Looking for pricing, stock, or lifecycle information?

Click below to explore more details on WIN SOURCE:

- ⊖ [View LTC3370EUH#TRPBF on WIN SOURCE](#)
- ⊖ [Analog Devices Inc. Information](#)

## Optimize Your Supply Chain with WIN SOURCE Solutions

- ✓ Global Sourcing Solution
- ✓ Obsolete Management
- ✓ Cost Control Management
- ✓ Shortage Management
- ✓ Alternative Solution
- ✓ Excess Inventory Management