

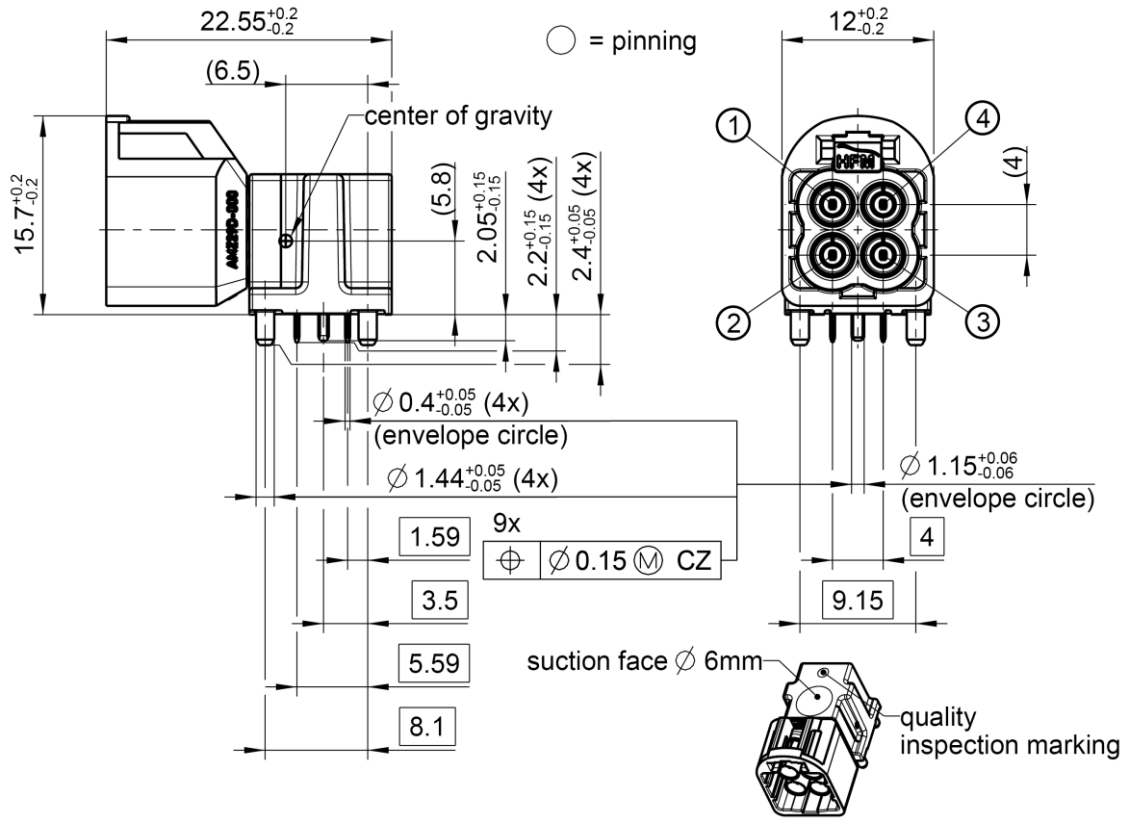

**THE DATASHEET OF
AMS29D-40MZ5-B**





All dimensions are in mm

Interface

According to RN_108-04

Documents

PCB layout MB_604
Tape & Reel packaging VG461.18500

Material and plating

Connector parts

Center contact

- Interface

- PCB

Outer contact (Interface)

Outer contact (PCB)

Outer contact sheet

Dielectric

Housing

Material

Bronze

Bronze

Zinc alloy

Bronze

LCP

HTN

Plating

Gold, min. 0.15 µm, over chemical nickel

Tin, min. 0.5 µm, over chemical nickel

Tin, min. 1.5 µm

Tin, min. 2 µm

Tin, min. 3 µm

Electrical data

Impedance	50 Ω
Frequency	DC to 9 GHz
Return loss	≥ 25 dB, DC to ≤ 3 GHz ≥ 20 dB, > 3 GHz to ≤ 6 GHz ≥ 12 dB, > 6 GHz to ≤ 9 GHz
Insertion loss	≤ 0.1 x √f(GHz) dB
Insulation resistance	≥ 1x10 ³ MΩ
Center contact resistance	≤ 15 mΩ
Outer contact resistance	≤ 5 mΩ
Test voltage	≤ 800 V rms
Working voltage	≤ 60 V DC
Power current	≤ 1 A DC
Cross talk (optional)	≤ -60 dB up to 10 GHz

- Connector only, VSWR in application depends decisive on PCB layout -

Mechanical data

Mating cycles	≥ 25
Engagement force	≤ 45 N*
Disengagement force	≥ 5 N
Retention force latch	≥ 110 N
Coding efficiency	≥ 150 N

* according to USCAR 25 Rev. 3 and the tests specified in USCAR 17 Rev.5 TG-G

Environmental data

Temperature range	-40 °C to +105 °C
Thermal shock	ISO 20860-2 clause 9.2
Temperature and humidity	ISO 20860-2 clause 9.3
Vibration and mechanical shock	ISO 20860-2 clause 9.1
Dry heat	ISO 20860-2 clause 9.4
Soldering profile	acc. to IEC 60068-2-58; Group 3 (250 °C / 30 s)
RoHS	compliant

Packing









Standard	185 pcs in tape & reel
Weight	7.63 g

Dieses Dokument ist urheberrechtlich geschützt • This document is protected by copyright • Rosenberger Hochfrequenztechnik GmbH & Co. KG

RF_35/09_14/6.2

Coding

Part number has to be accomplished by codification

Coding	Color	RAL	Part-Number-RT
 A	black	sim. 9005	AMS29D-40MZ5-A
 B	white	sim. 9010	AMS29D-40MZ5-B
 C	blue	sim. 5012	AMS29D-40MZ5-C
 D	claret violet	sim. 4004	AMS29D-40MZ5-D
 E	green	sim. 6017	AMS29D-40MZ5-E
 F	brown	sim. 8011	AMS29D-40MZ5-F
 G	grey	sim. 7036	AMS29D-40MZ5-G
 Z	waterblue	sim. 5021	AMS29D-40MZ5-Z

(b)

Change History

Rev.	Date	Change
a00	10.02.22	Initial release
b00	18.05.22	Coding changed

While the information has been carefully compiled to the best of our knowledge, nothing is intended as representation or warranty on our part and no statement herein shall be construed as recommendation to infringe existing patents. In the effort to improve our products, we reserve the right to make changes judged to be necessary.

Draft	Date	Approved	Date	Rev.	Engineering change number	Name	Date
F. Bachmeier	26.03.19	T. Georg	18.05.2022	b00	22-0781	A. Krause	18.05.2022

Looking for pricing, stock, or lifecycle information?

Click below to explore more details on WIN SOURCE:

- ⊖ [View AMS29D-40MZ5-B on WIN SOURCE](#)
- ⊖ [Rosenberger Information](#)

Optimize Your Supply Chain with WIN SOURCE Solutions

- ✓ Global Sourcing Solution
- ✓ Obsolete Management
- ✓ Cost Control Management
- ✓ Shortage Management
- ✓ Alternative Solution
- ✓ Excess Inventory Management