



**THE DATASHEET OF
TYS8040151M-10**



TYS-Low Profile SMT Power Inductor

TYS8040 Series

FEATURES AND APPLICATIONS

Laird **TYS series high current power inductors** improve performance, reliability and power efficiency. A lower profile benefits consumer electronics, industrial and telecom design. Products feature extremely low DCR with greater efficiency and enable a large current in a small size. Inductors are of magnetic shielding and wire wound construction and perform in operating temperatures ranging from -40 C to 125 C including self-heating rise in temperature.

FEATURES

- Magnetic shielded structure
- Low DCR and high efficiency
- Low profile and small size
- Ferrite core with high saturation

APPLICATIONS

- DC-DC Converter and Power Suppliers
- LCD TV'S and Gaming Console
- Tablet, Notebooks, Servers and Printers
- Networking and Data storage
- GPS, Set-top-box and Base stations
- Smart meters and Medical instruments



PART NUMBER EXPLANATION

TYS 8040 4R7 M - 10

Product series code	Product size code	Inductance value code (i.e. 4R7: 4.7 μ H)	Tolerance % (i.e. M: \pm 20%)	Standard Catalog P.N
---------------------	-------------------	---	---------------------------------	----------------------

ELECTRICAL SPECIFICATIONS

- Tolerance: M: \pm 20% or N: \pm 30%
- Inductance tested at 1MHz, 1.0Vrms
- Heat Rated Current (Irms) is defined based on temperature rise approximate 40°C (ambient temperature 25 \pm 5°C)
- Saturation Current (Isat) is the DC current at which the inductance drops off approximately 30% from its value without current. (ambient temperature 25 \pm 5°C)
- Operating temperature range: -40°C~+125°C (including self-heating temperature rise)
- Storage temperature range (packaging conditions): -10°C~+40°C and RH 70%(MAX.)

Note: Heat Rated Current (Irms) is tested on a typical PCB and apply a constant current in still air. The temperature rise is dependent on the application system condition including PCB PAD pattern, trace width and thickness and adjacent components etc. It's suggested to verify the temperature rise of the component under the real operation application conditions.

SPECIFICATION

1.MECHANICAL & DIMENSIONS

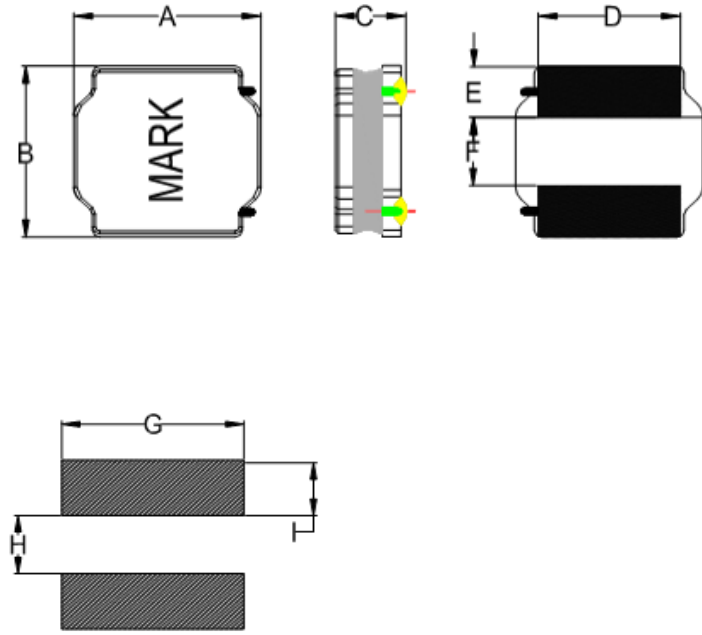

(UNIT: mm)	
A	8.00±0.30
B	8.00±0.30
C	4.0+0.2/-0.3
D	6.30±0.30
E	2.00±0.30
F	4.00±0.30
G	7.5 REF
H	3.8 REF
T	2.2 REF
REMARK	

2.PART NUMBER NOMENCLATOR:

TYS 8040 4R7 M - 10
A B C D E

- A: Product Series.
- B: Series number, part size
- C: Inductance code

- D: Inductance Tolerance. (M=±20% ,N=±30%)
- E: "X"=0:Standard catalog part number
- "X"=1-9:Controlled customized part **OR** different performance than std catalog part.

3.EQUIVALENT CIRCUIT:

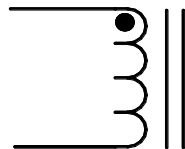

SPECIFICATION

PART NUMBER	INDUCTANCE (uH)	Irms(A) Typ.	Isat(A) Typ.	DCR(mΩ) TYP	DCR(mΩ) Max	SRF MHz
TYS8040R90N-10	0.90	6.30	13.80	8.0	10.4	94
TYS80401R0N-10	1.00	6.30	9.85	8.0	10.4	89
TYS80401R4N-10	1.40	5.65	8.15	10.0	13.0	67
TYS80402R2N-10	2.20	5.15	7.10	12.0	15.6	41
TYS80403R3N-10	3.30	4.40	6.50	17.0	22.1	27
TYS80404R7N-10	4.70	4.10	5.90	19.0	24.7	24
TYS80406R8M-10	6.80	3.60	4.55	24.0	31.2	20
TYS8040100M-10	10.00	3.30	3.60	29.0	37.7	15
TYS8040150M-10	15.00	2.60	2.95	47.0	61.1	12
TYS8040220M-10	22.00	2.10	2.40	69.0	89.7	9.5
TYS8040330M-10	33.00	1.80	2.05	97.0	126.1	7.8
TYS8040470M-10	47.00	1.55	1.75	136.0	176.8	6.4
TYS8040680M-10	68.00	1.25	1.45	196.0	254.8	4.9
TYS8040101M-10	100.00	1.00	1.15	290.0	377.0	4.2
TYS8040151M-10	150.00	0.85	1.10	410.00	533.00	3.5
TYS8040221M-10	220.00	0.80	0.85	599.0	778.7	3.5
TYS8040331M-10	330.00	0.64	0.68	889.0	1155.7	2.8

GENERAL SPECIFICATION:
<ul style="list-style-type: none"> • Tolerance: M: ±20% or N: ±30%
<ul style="list-style-type: none"> • Inductance tested at 100KHz, 1.0Vrms
<ul style="list-style-type: none"> • Heat Rated Current (Irms) is defined based on temperature rise approximate 40°C (ambient temperature 25±5°C)
<ul style="list-style-type: none"> • Saturation Current (Isat) is the DC current at which the inductance drops off approximately 30% from its value without current. (ambient temperature 25±5°C)
<ul style="list-style-type: none"> • Operating temperature range: -40°C~+125°C (including self-heating temperature rise)
<ul style="list-style-type: none"> • Storage temperature range (packaging conditions): -10°C~+40°C and RH 70%(MAX.)

SPECIFICATION

Characteristics Curve

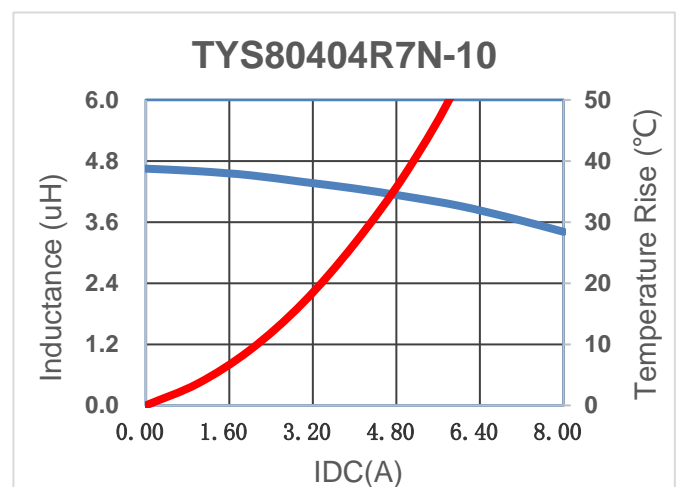
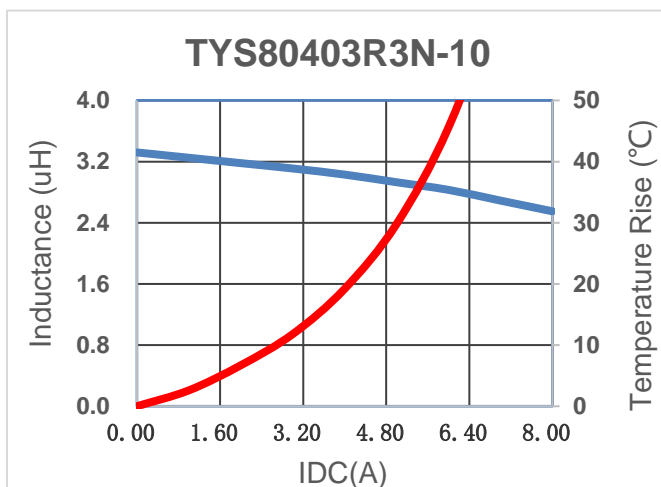
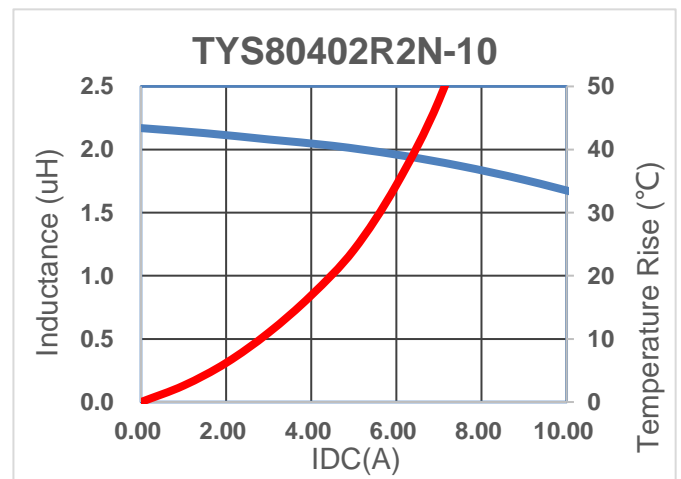
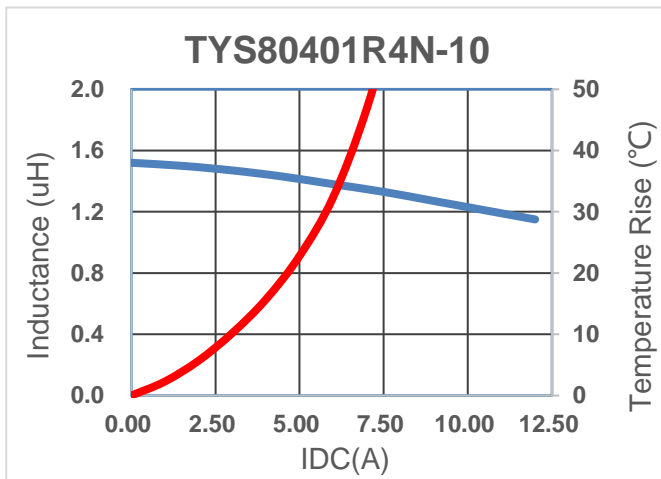
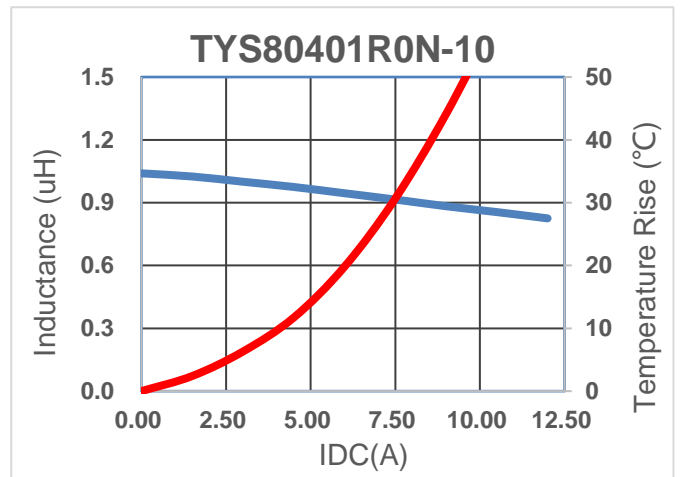
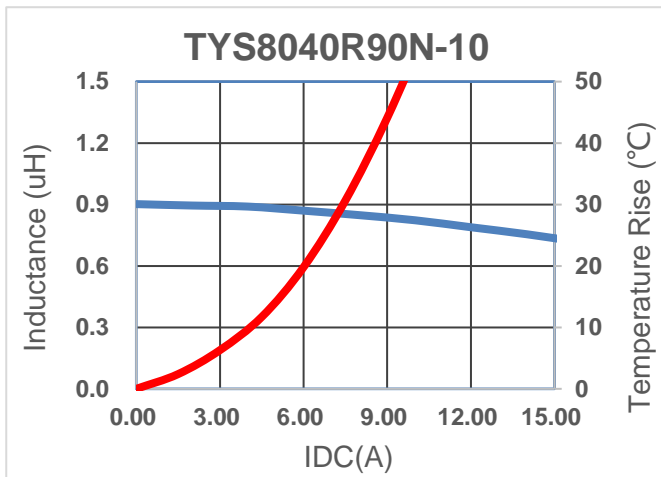

SPECIFICATION

Characteristics Curve

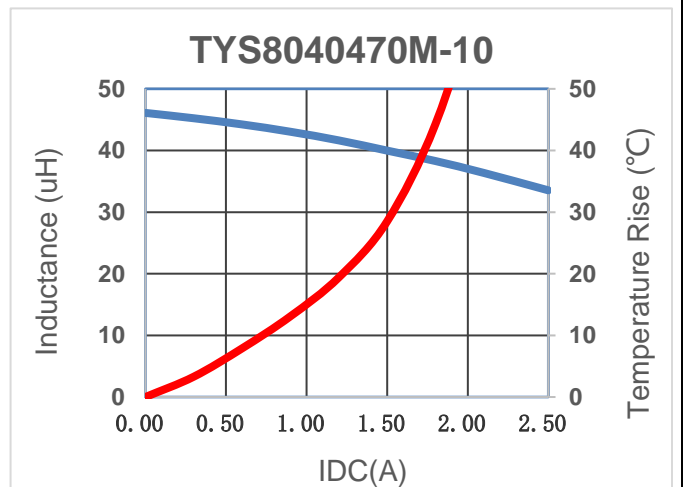
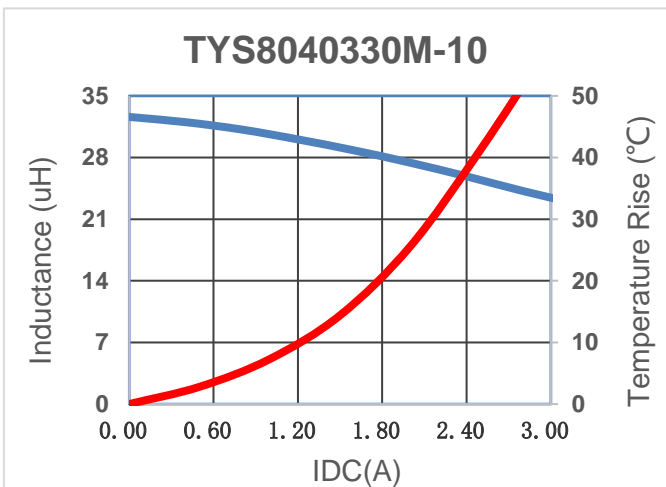
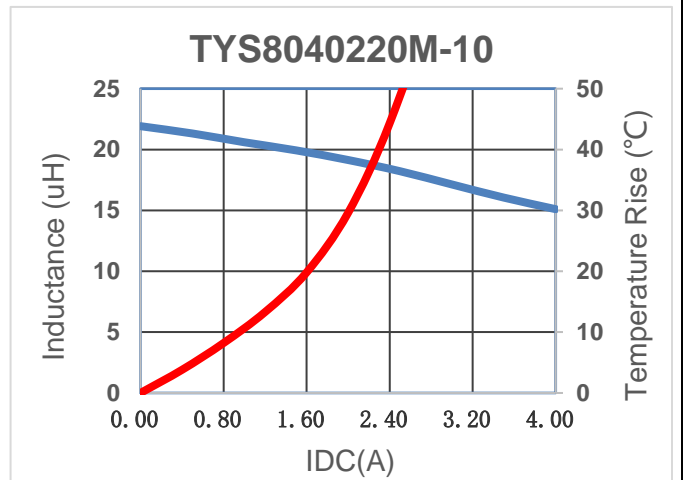
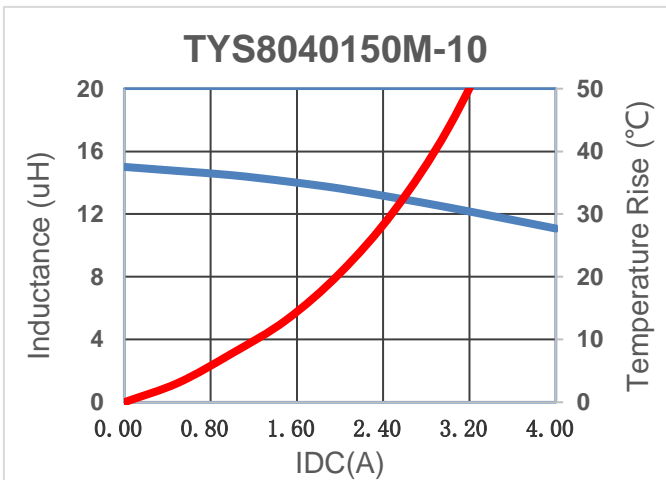
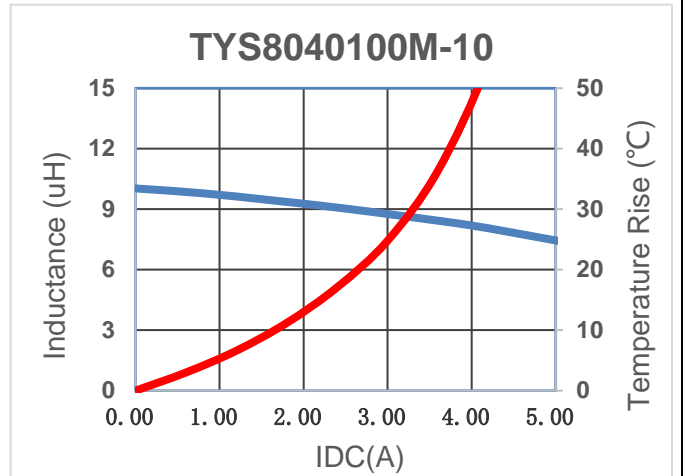
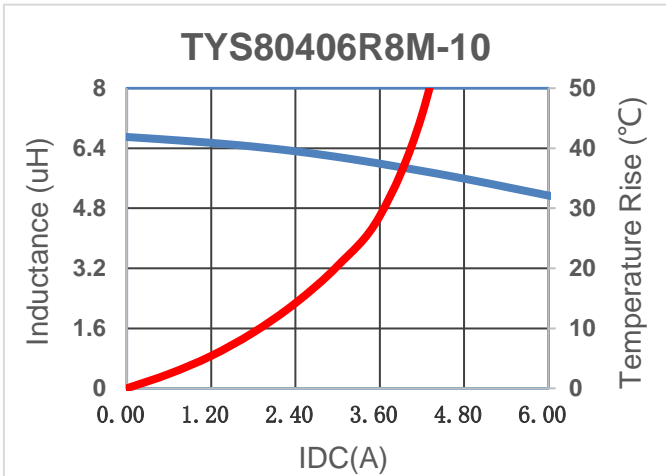

SPECIFICATION

Characteristics Curve

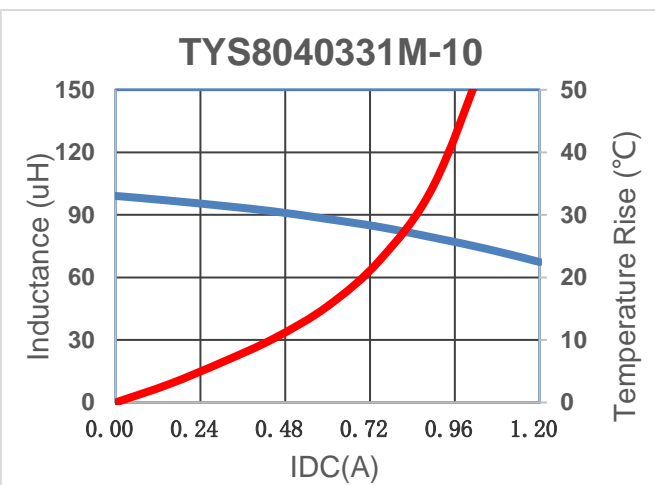
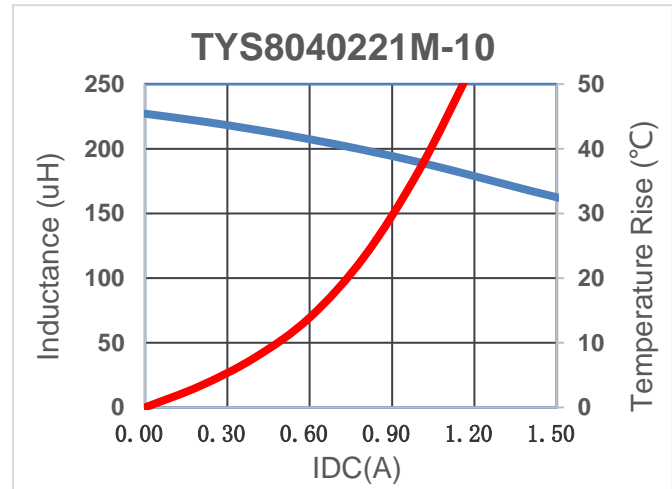
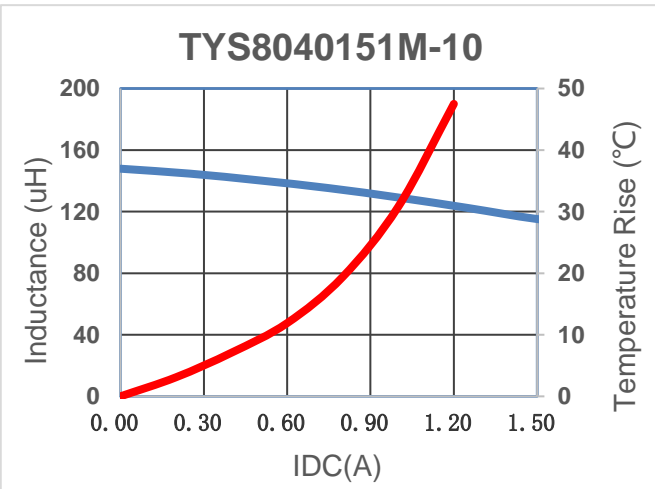
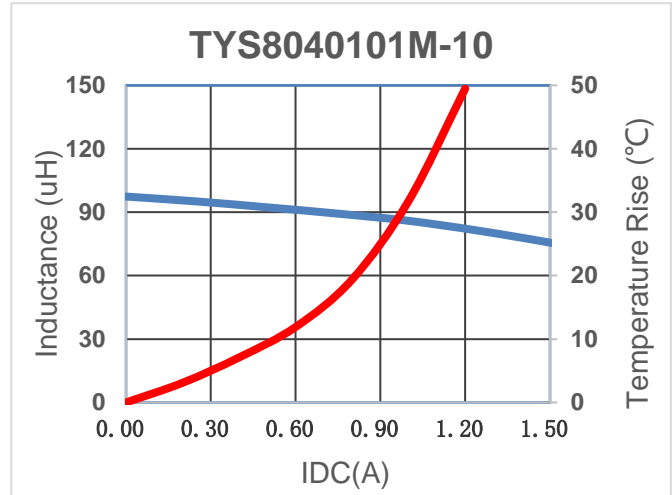
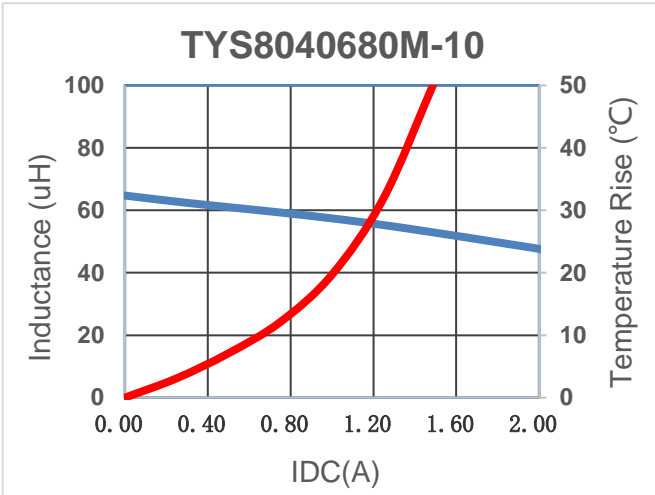

Recommended Soldering Conditions

For Lead-Free Application

Figure 1 . Re-flow Soldering

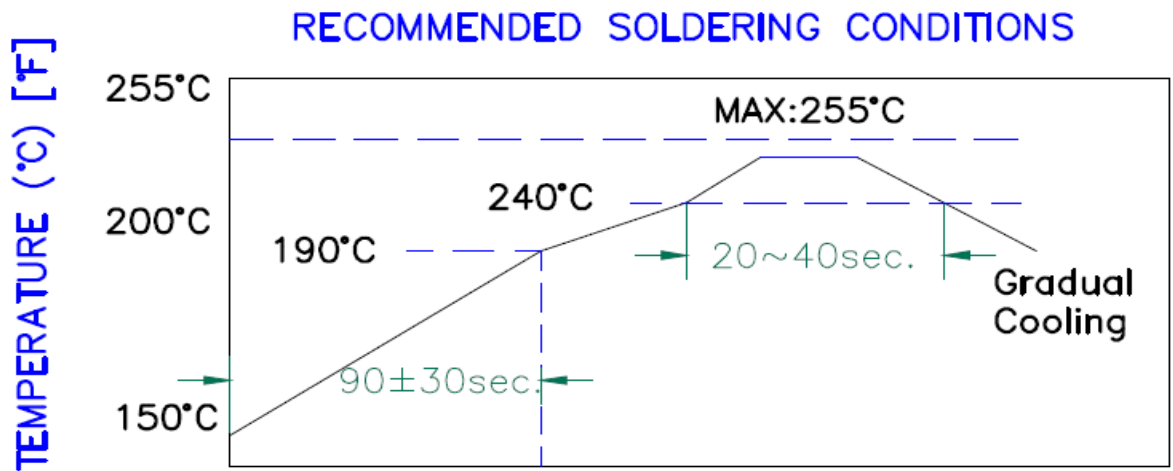

Reliability and Testing Conditions / Pin Type Power Inductors

SMD series(Consumer)		
Item	Reference	Additional Requirements
Operating temperature range	-40°C ~ +125°C (Including self-temperature rise)	
Storage temperature and humidity range	-10°C to +40°C , 70% RH Max	
High Temperature Exposure (Storage)	MIL-STD-202 Method 108	85±2°C, 168+24hours
Temperature Cycling	JESD22 Method JA-104	-40°C → +85, transforming interval:20s, 100cycles
Operational Life	MIL-PRF-2	85±2°C, 168+24hours Apply maximum rated voltage and current according part drawing
External Visual	MIL-STD-883 Method 2009	Inspect device construction, marking and workmanship. Electrical Test not required.
Physical Dimension	JESD22 Method JB-100	Verify physical dimensions to the applicable device detail specification. Note: User(s) and Suppliers spec. Electrical Test not required
Vibration	MIL-STD-202 Method 204	10~55Hz, 1.5mm, 2 hours in each 3 mutually perpendicular directions (total of 6 hours)
Resistance to Soldering Heat	MIL-STD-202 Method 210	1. Max. 260±5°C, 10±1s, 2 times 2. Solder Composition: Sn/3Ag/0.5Cu
Solderability	J-STD-002	245±5°C, 5±1sec, Solder: Sn/3.0Ag/0.5Cu
Electrical Characterization	Print Spec	Parametrically test per lot and sample size requirements, summary to show Min, Max, Mean and Standard deviation at room as well as Min and Max Operating temperatures
Board Flex	AEC-Q200-005	2mm, 30±1s
Terminal Strength(SMD)	AEC-Q200-006	10N, 5S, X,Y direct

PACKAGING

Reel Dimension

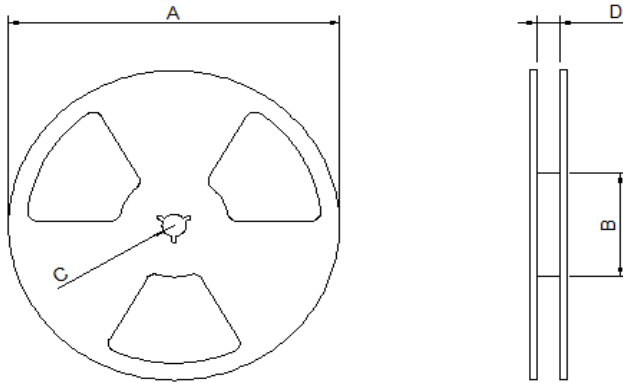

Tape Dimension

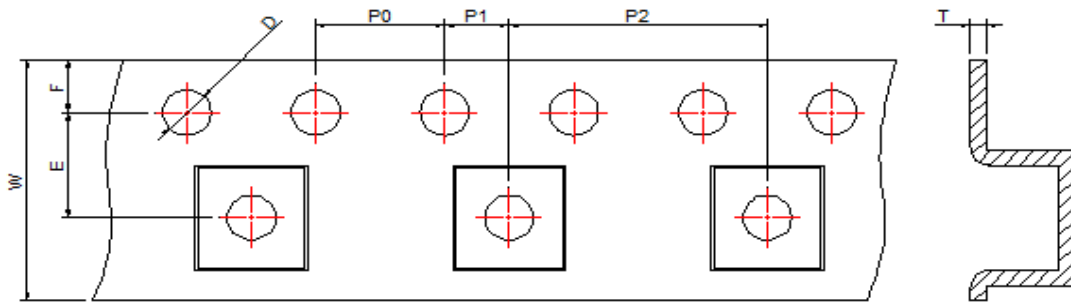

W	E	F	P0	P1	P2	T	D
12.0±0.3	5.5±0.1	1.75±0.1	4.0±0.1	2.0±0.1	8.0±0.1	0.3±0.05	1.5±0.1

Packaging Quantity

P/N	Chip/Reel
TYS8040 series	1000pcs

Peeling Off Force

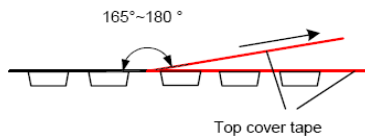



The force peeling off cover tape is 10 to 100 grams in the arrow direction under the following conditions			
Room Temp	Room Humidity (%)	Room atrn (hPa)	Teaming Speed (mm/min)
5~35	45~85	860~1060	300

※Storage Conditions

1. Temperature and humidity conditions: -10~+40°C and 70% RH.
2. Recommended products should be used within 12 months from the time of manufacturing.
3. The packaging material should be kept where no chlorine or sulfur exists in the air.
4. Allowable stacking condition of Packaging box: max height 1.5m or 5 boxes stacking

Looking for pricing, stock, or lifecycle information?

Click below to explore more details on WIN SOURCE:

-  [View TYS8040151M-10 on WIN SOURCE](#)
-  [Laird-Signal Integrity Products Information](#)

Optimize Your Supply Chain with WIN SOURCE Solutions

-  Global Sourcing Solution
-  Obsolete Management
-  Cost Control Management
-  Shortage Management
-  Alternative Solution
-  Excess Inventory Management