



**THE DATASHEET OF  
IXGT10N170A**



# High Voltage IGBT

**IXGH 10N170A**  
**IXGT 10N170A**

$V_{CES} = 1700 \text{ V}$   
 $I_{C25} = 10 \text{ A}$   
 $V_{CE(sat)} = 6.0 \text{ V}$   
 $t_{fi(typ)} = 35 \text{ ns}$

## Preliminary Data Sheet

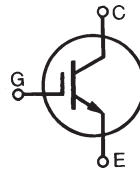

Symbol	Test Conditions	Maximum Ratings	
$V_{CES}$	$T_J = 25^\circ\text{C}$ to $150^\circ\text{C}$	1700	V
$V_{CGR}$	$T_J = 25^\circ\text{C}$ to $150^\circ\text{C}$ ; $R_{GE} = 1 \text{ M}\Omega$	1700	V
$V_{GES}$	Continuous	$\pm 20$	V
$V_{GEM}$	Transient	$\pm 30$	V
$I_{C25}$	$T_C = 25^\circ\text{C}$	10	A
$I_{C90}$	$T_C = 90^\circ\text{C}$	5	A
$I_{CM}$	$T_C = 25^\circ\text{C}$ , 1 ms	20	A
<b>SSOA (RBSOA)</b>	$V_{GE} = 15 \text{ V}$ , $T_{VJ} = 125^\circ\text{C}$ , $R_G = 22\Omega$ Clamped inductive load	$I_{CM} = 20$ @ $0.8 V_{CES}$	A
$t_{SC}$	$T_J = 125^\circ\text{C}$ , $V_{CE} = 1200 \text{ V}$ ; $V_{GE} = 15 \text{ V}$ , $R_G = 22\Omega$	10	$\mu\text{s}$
$P_C$	$T_C = 25^\circ\text{C}$	140	W
$T_J$		-55 ... +150	$^\circ\text{C}$
$T_{JM}$		150	$^\circ\text{C}$
$T_{stg}$		-55 ... +150	$^\circ\text{C}$
$M_d$	Mounting torque (M3) (TO-247)	1.13/10Nm/lb.in.	
Maximum lead temperature for soldering 1.6 mm (0.062 in.) from case for 10 s		300	$^\circ\text{C}$
<b>Weight</b>		TO-247 TO-268	6 4 g

### TO-268 (IXGT)

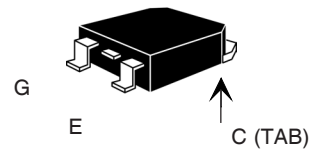

### TO-247 AD (IXGH)

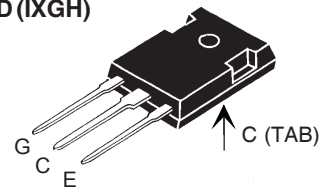

G = Gate, C = Collector,  
E = Emitter, TAB = Collector

### Features

- International standard packages JEDEC TO-268 and JEDEC TO-247 AD
- High current handling capability
- Very high frequency
- MOS Gate turn-on - drive simplicity
- Rugged NPT structure
- Molding epoxies meet UL 94 V-0 flammability classification

### Applications

- Pulsar circuits
- AC motor speed control
- DC servo and robot drives
- DC choppers
- Uninterruptible power supplies (UPS)
- Switched-mode and resonant-mode power supplies

### Advantages

- High power density
- Suitable for surface mounting
- Easy to mount with 1 screw, (isolated mounting screw hole)

Symbol	Test Conditions	Characteristic Values ( $T_J = 25^\circ\text{C}$ , unless otherwise specified)		
		min.	typ.	max.
$BV_{CES}$	$I_C = 250 \mu\text{A}$ , $V_{GE} = 0 \text{ V}$	1700		V
$V_{GE(th)}$	$I_C = 250 \mu\text{A}$ , $V_{CE} = V_{GE}$	3.0		V
$I_{CES}$	$V_{CE} = 0.8 \cdot V_{CES}$ $V_{GE} = 0 \text{ V}$		$T_J = 25^\circ\text{C}$ $T_J = 125^\circ\text{C}$	25 500 $\mu\text{A}$
$I_{GES}$	$V_{CE} = 0 \text{ V}$ , $V_{GE} = \pm 20 \text{ V}$			$\pm 100 \text{ nA}$
$V_{CE(sat)}$	$I_C = I_{C90}$ , $V_{GE} = 15 \text{ V}$	$T_J = 25^\circ\text{C}$ $T_J = 125^\circ\text{C}$	4.5 5.2	V V

Symbol	Test Conditions	Characteristic Values ( $T_J = 25^\circ\text{C}$ , unless otherwise specified)		
		min.	typ.	max.
$g_{fs}$	$I_C = I_{C25}; V_{CE} = 20\text{ V}$ Note 2	3	5	S
$C_{ies}$	$V_{CE} = 25\text{ V}, V_{GE} = 0\text{ V}, f = 1\text{ MHz}$		650	pF
$C_{oes}$			40	pF
$C_{res}$			22	pF
$Q_G$	$I_C = I_{C90}; V_{GE} = 15\text{ V}, V_{CE} = 0.5 V_{CES}$		29	nC
$Q_{GE}$			5	nC
$Q_{GC}$			10	nC
$t_{d(on)}$	<b>Inductive load, <math>T_J = 25^\circ\text{C}</math></b> $I_C = I_{C25}, V_{GE} = 15\text{ V}$ $R_G = 22\ \Omega, V_{CE} = 0.5 V_{CES}$		46	ns
$t_{ri}$			57	ns
$t_{d(off)}$			190	360 ns
$t_{fi}$			35	ns
$E_{off}$			0.38	0.8 mJ
$t_{d(on)}$	<b>Inductive load, <math>T_J = 125^\circ\text{C}</math></b> $I_C = I_{C25}, V_{GE} = 15\text{ V}$ $R_G = 22\ \Omega, V_{CE} = 0.5 V_{CES}$		48	ns
$t_{ri}$			59	ns
$E_{on}$			1.2	mJ
$t_{d(off)}$			200	ns
$t_{fi}$			40	ns
$E_{off}$		0.6	mJ	
$R_{thJC}$	(TO-247)			0.89 K/W
$R_{thCK}$			0.25	K/W

Notes: 1. Device must be heatsunk for high temperature leakage current measurements to avoid thermal runaway.

2. Pulse test,  $t \leq 300\ \mu\text{s}$ , duty cycle  $\leq 2\%$

### TO-247 AD Outline

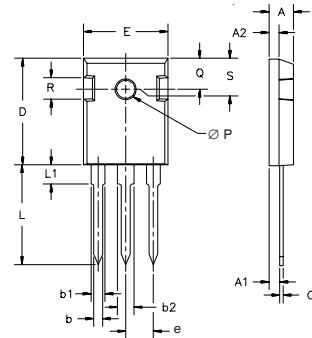

Dim.	Millimeter		Inches	
	Min.	Max.	Min.	Max.
A	4.7	5.3	.185	.209
A <sub>1</sub>	2.2	2.54	.087	.102
A <sub>2</sub>	2.2	2.6	.059	.098
b	1.0	1.4	.040	.055
b <sub>1</sub>	1.65	2.13	.065	.084
b <sub>2</sub>	2.87	3.12	.113	.123
C	.4	.8	.016	.031
D	20.80	21.46	.819	.845
E	15.75	16.26	.610	.640
e	5.20	5.72	0.205	0.225
L	19.81	20.32	.780	.800
L1		4.50		.177
∅P	3.55	3.65	.140	.144
Q	5.89	6.40	0.232	0.252
R	4.32	5.49	.170	.216
S	6.15	BSC	.242	BSC

### TO-268 Outline

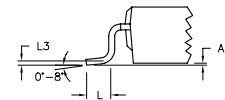
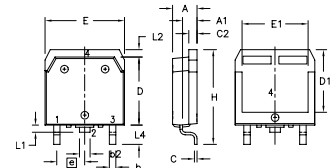

Dim.	Millimeter		Inches	
	Min.	Max.	Min.	Max.
A	4.9	5.1	.193	.201
A <sub>1</sub>	2.7	2.9	.106	.114
A <sub>2</sub>	.02	.25	.001	.010
b	1.15	1.45	.045	.057
b <sub>2</sub>	1.9	2.1	.75	.83
C	.4	.65	.016	.026
D	13.80	14.00	.543	.551
E	15.85	16.05	.624	.632
E <sub>1</sub>	13.3	13.6	.524	.535
e	5.45	BSC	.215	BSC
H	18.70	19.10	.736	.752
L	2.40	2.70	.094	.106
L1	1.20	1.40	.047	.055
L2	1.00	1.15	.039	.045
L3		0.25		.010
L4	3.80	4.10	.150	.161

IXYS reserves the right to change limits, test conditions, and dimensions.

**Fig. 1. Output Characteristics**  
@ 25 Deg. C

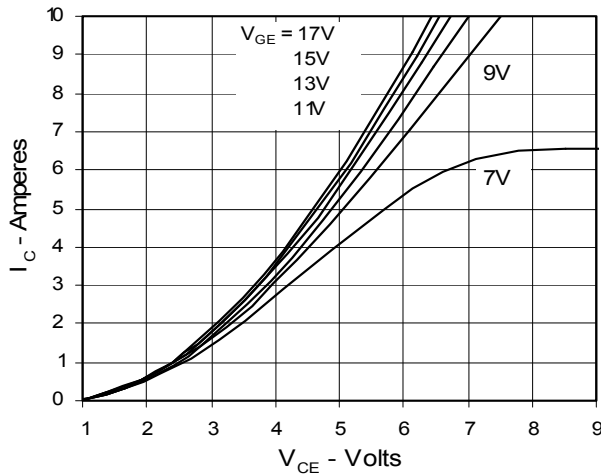

**Fig. 2. Extended Output Characteristics**  
@ 25 deg. C

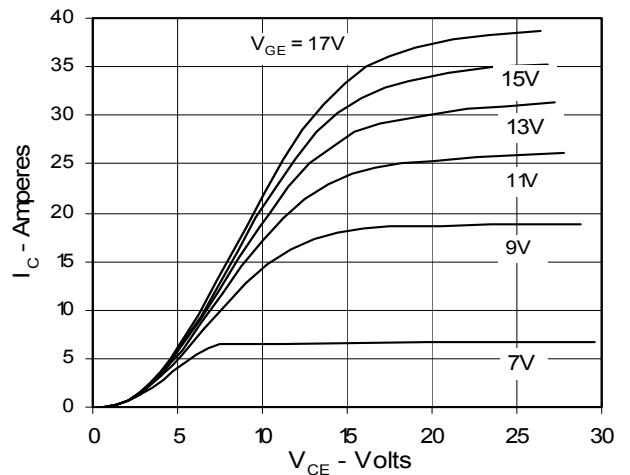

**Fig. 3. Output Characteristics**  
@ 125 Deg. C

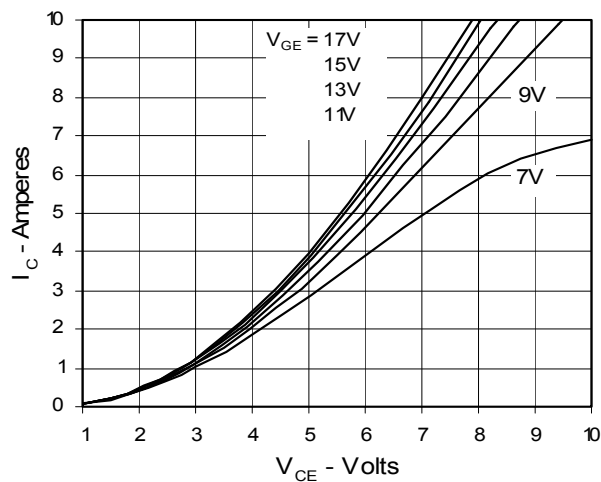

**Fig. 4. Temperature Dependence of  $V_{CE(sat)}$**

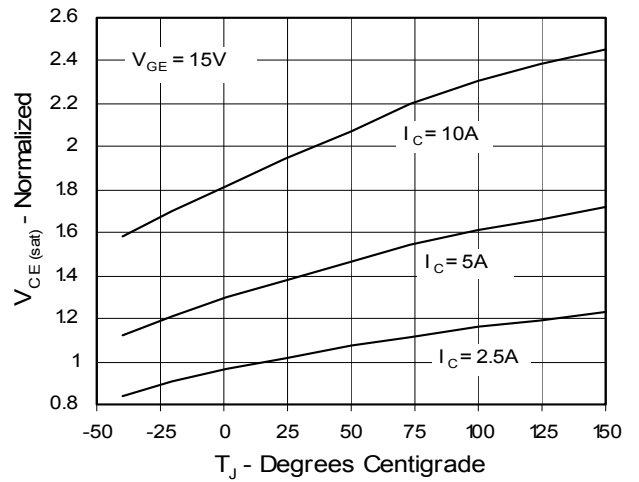

**Fig. 5. Collector-to-Emitter Voltage vs. Gate-to-Emitter voltage**

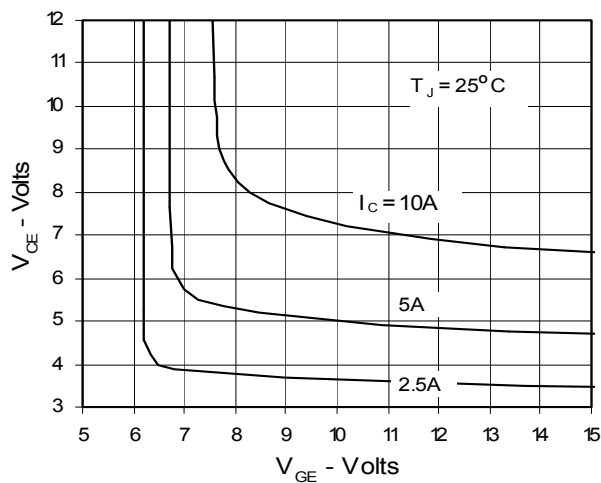

**Fig. 6. Input Admittance**

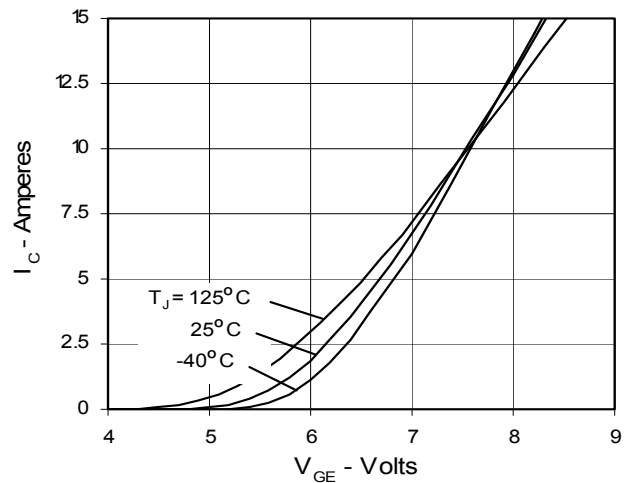

**Fig. 7. Transconductance**

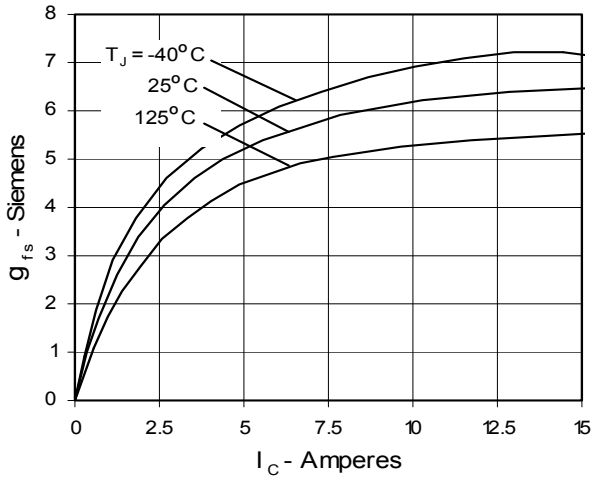

**Fig. 8. Dependence of  $E_{off}$  on  $R_G$**

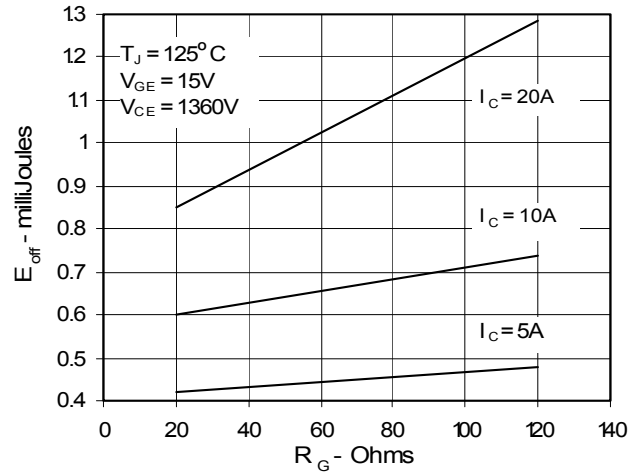

**Fig. 9. Dependence of  $E_{off}$  on  $I_C$**

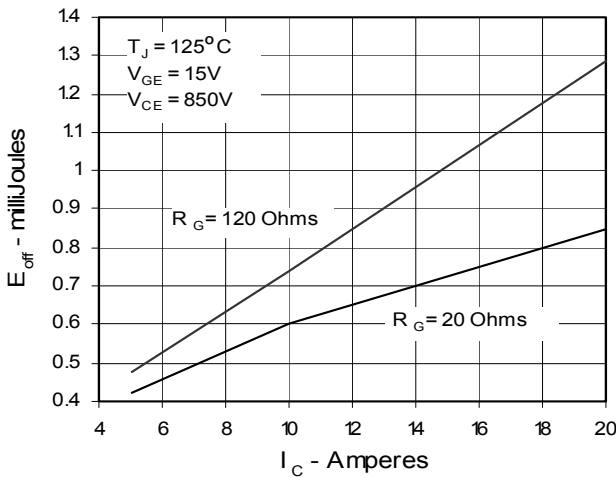

**Fig. 10. Dependence of  $E_{off}$  on Temperature**

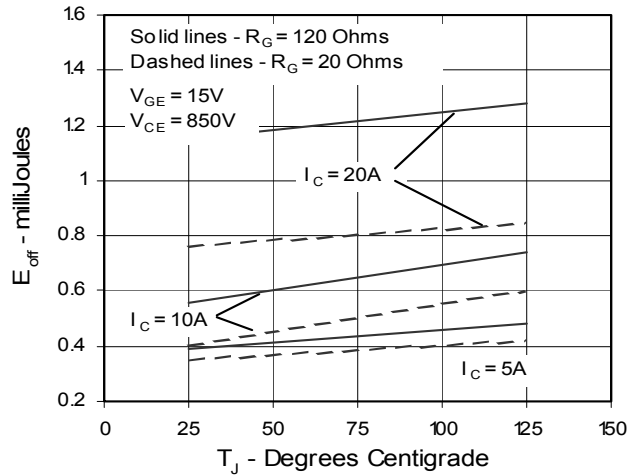

**Fig. 11. Gate Charge**

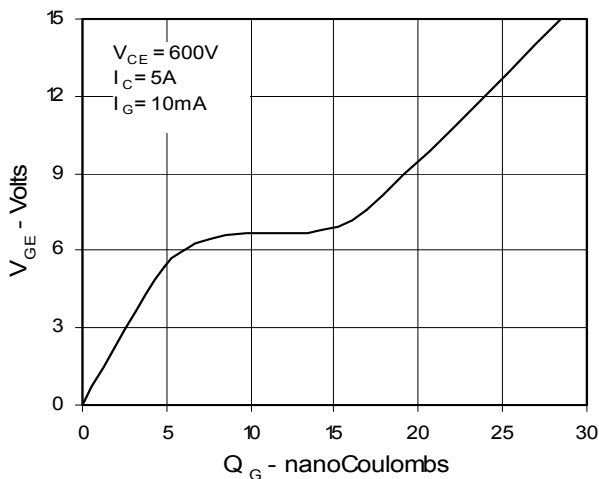

**Fig. 12. Capacitance**

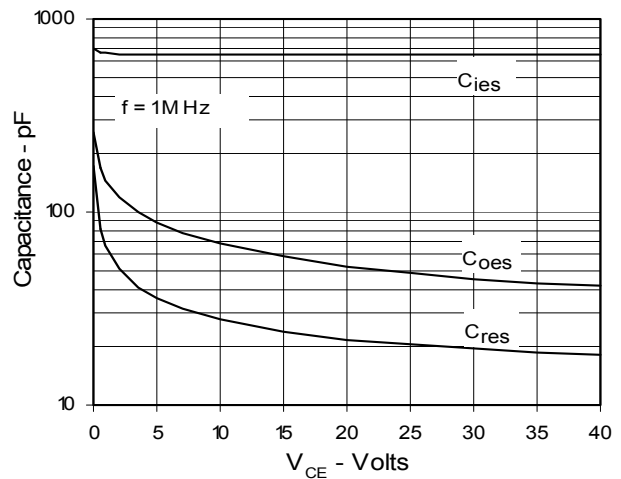

IXYS reserves the right to change limits, test conditions, and dimensions.

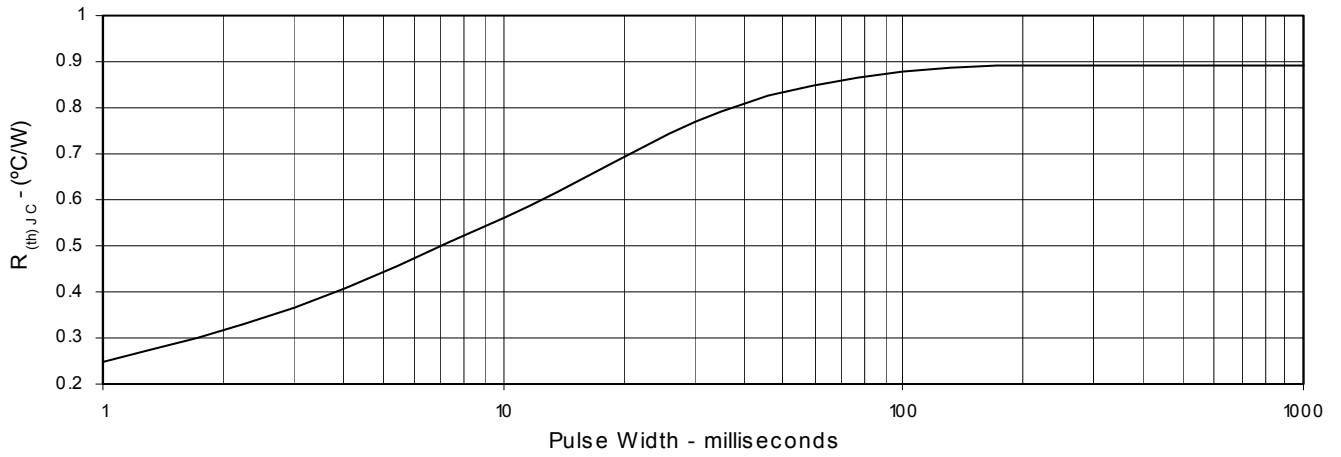
**Fig. 13. Maximum Transient Thermal Resistance**





---







Disclaimer Notice - Information furnished is believed to be accurate and reliable. However, users should independently evaluate the suitability of and test each product selected for their own applications. Littelfuse products are not designed for, and may not be used in, all applications. Read complete Disclaimer Notice at [www.littelfuse.com/disclaimer-electronics](http://www.littelfuse.com/disclaimer-electronics).

## Looking for pricing, stock, or lifecycle information?

Click below to explore more details on WIN SOURCE:

-  [View IXGT10N170A on WIN SOURCE](#)
-  [IXYS Information](#)

## Optimize Your Supply Chain with WIN SOURCE Solutions

-  Global Sourcing Solution
-  Obsolete Management
-  Cost Control Management
-  Shortage Management
-  Alternative Solution
-  Excess Inventory Management