



**THE DATASHEET OF
LT3072IUFF#TRPBF**



Dual, Low Noise, 2.5A Programmable Output, 80mV Low Dropout Linear Regulator

FEATURES

- **Dual, Independent 2.5A Outputs**
- **Dropout Voltage: 80mV**
- **Low Output Noise: 12μV_{RMS} (10Hz to 100kHz)**
- Digitally Programmable V_{OUT} : 0.6V to 2.5V
- Output Tolerance: ±1.25%/±1.5% Over Load, Line and Temperature
- Analog Output Margining: ±10% Range
- Parallel Multiple Devices for Higher Current
- Programmable Precision Current Limit: ±7%
- Output Current Monitor: $I_{MON} = I_{OUT}/3000$
- High Frequency PSRR: 30dB at 1MHz
- Stable with Ceramic Output Capacitors (10μF Minimum)
- VIOC Pin Controls Buck Converter to Maintain Low Power Dissipation and Optimize Efficiency
- PWRGD/UVLO Flags
- Current Limit and Thermal Shutdown Protection
- Temperature Monitor
- 36-Lead 4mm × 7mm QFN Package

APPLICATIONS

- FPGA, DSP and Microprocessor Power Supplies
- Low Noise RF Power Supplies
- High-Speed Servers and Storage Devices
- Post Buck Regulation and Supply Isolation

DESCRIPTION

The **LT[®]3072** is a low voltage, UltraFast™ transient response, dual channel linear regulator. The device supplies up to 2.5A per channel with a typical dropout voltage of 80mV. A 0.1μF reference bypass capacitor decreases output voltage noise to 12μV_{RMS}. The wide bandwidth and high PSRR permit the use of small ceramic capacitors, saving bulk capacitance and cost. The LT3072 is ideal for high performance FPGAs, microprocessors and sensitive RF communication supply applications.

Independent output voltages are digitally selectable in 50mV increments from 0.6V to 1.2V and in 100mV increments from 1.2V to 2.5V. Output current monitors provide diagnostics and program the precision current limit. The LT3072 incorporates a unique tracking feature (VIOC) to control the upstream buck regulator(s) powering the inputs. VIOC adaptively servos the buck regulator to maintain the LT3072 input-to-output voltage differential to 300mV at maximum load and 450mV at light load, minimizing power dissipation with less input capacitance. Internal protection circuitry includes UVLO, OVLO, reverse-current protection, current limiting and thermal shutdown. The LT3072 is available in a low profile (0.75mm) 36-lead 4mm × 7mm QFN package.

All registered trademarks and trademarks are the property of their respective owners.

TYPICAL APPLICATION

2.5V/0.6V, 2.5A Regulators

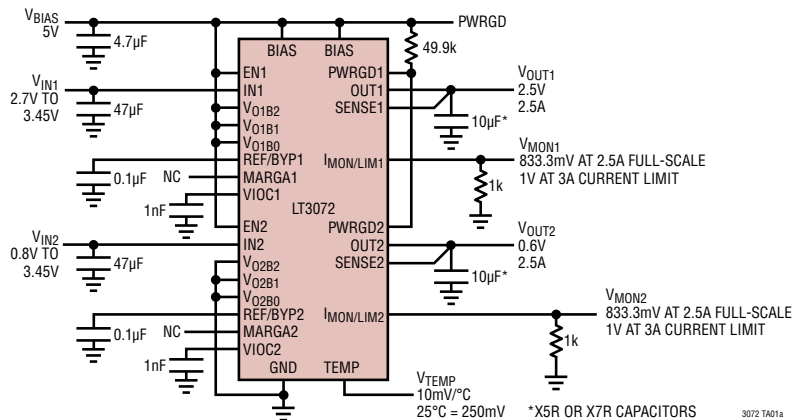

Dropout Voltage vs Load Current

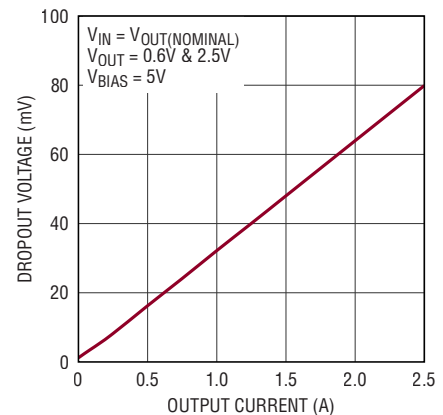

ABSOLUTE MAXIMUM RATINGS

(Note 1)

IN1, 2 Pin Voltage	-0.3V to 3.6V
OUT1, 2 Pin Voltage	-0.3V to 3.6V
SENSE1, 2 Pin Voltage	-0.3V to 3.6V
BIAS Pin Voltage	-0.3V to 5.5V
$V_{O1,2B2}$, $V_{O1,2B1}$, $V_{O1,2B0}$ Pin Voltage	-0.3V to BIAS
EN1, 2 Pin Voltage	-0.3V to BIAS
VIOC1, 2 Pin Voltage	-0.3V to BIAS
PWRGD1, 2 Pin Voltage	-0.3V to BIAS
$I_{MON/LIM1,2}$ Pin Voltage	-0.3V to BIAS
TEMP Pin Voltage	-0.3V to 2V
REF/BYP1, 2 Pin Voltage	-0.3V to 2V
MARGA1, 2 Pin Voltage	-0.3V to 2V
Output Short-Circuit Duration	Indefinite
Operating Junction Temperature (Note 2)	
E-Grade, I-Grade	-40°C to 125°C
Storage Temperature Range	-65°C to 150°C

PIN CONFIGURATION

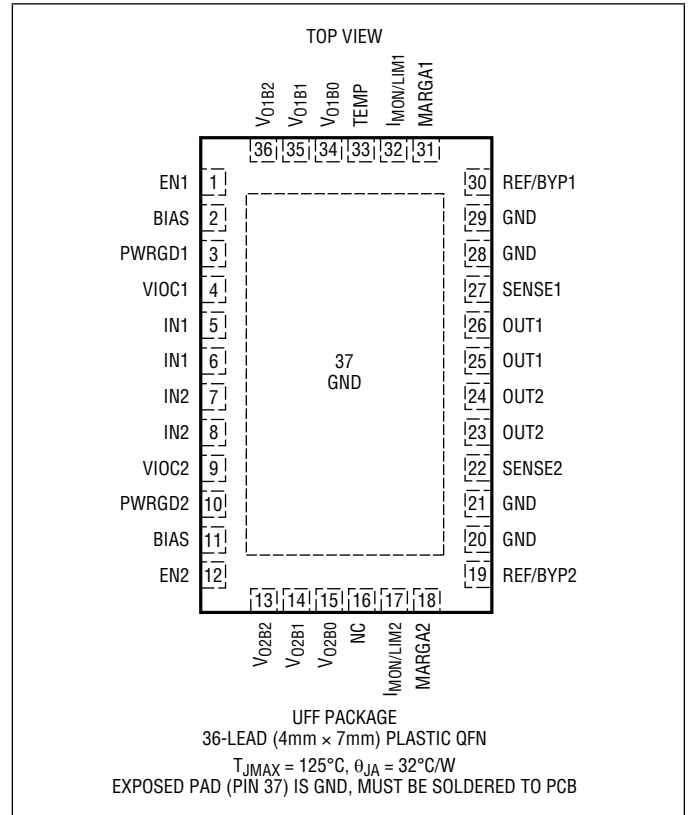

ORDER INFORMATION

LEAD FREE FINISH	TAPE AND REEL	PART MARKING*	PACKAGE DESCRIPTION	TEMPERATURE RANGE
LT3072EUFF#PBF	LT3072EUFF#TRPBF	3072	36-Lead (4mm × 7mm) Plastic QFN	−40°C to 125°C
LT3072IUFF#PBF	LT3072IUFF#TRPBF	3072	36-Lead (4mm × 7mm) Plastic QFN	−40°C to 125°C

Contact the factory for parts specified with wider operating temperature ranges. *The temperature grade is identified by a label on the shipping container.

[Tape and reel specifications](#). Some packages are available in 500 unit reels through designated sales channels with #TRMPBF suffix.

ELECTRICAL CHARACTERISTICS

The ● denotes the specifications which apply over the full operating temperature range, otherwise specifications are at $T_A = 25^\circ\text{C}$. $R_{MON} = 1\text{k}\Omega$, unless otherwise noted.

PARAMETER	CONDITIONS	MIN	TYP	MAX	UNITS	
IN Pin Voltage		●		3.45	V	
BIAS Pin Voltage (Note 5)		●	2.375	5.25	V	
Regulated Output Voltage (Note 4)	$V_{OUT} = 0.6\text{V}$, $10\text{mA} \leq I_{OUT} \leq 2.5\text{A}$, $0.90\text{V} \leq V_{IN} \leq 1.05\text{V}$	●	0.591	0.600	0.609	V
	$V_{OUT} = 1.0\text{V}$, $10\text{mA} \leq I_{OUT} \leq 2.5\text{A}$, $1.3\text{V} \leq V_{IN} \leq 1.45\text{V}$	●	0.985	1.000	1.015	V
	$V_{OUT} = 1.2\text{V}$, $10\text{mA} \leq I_{OUT} \leq 2.5\text{A}$, $1.5\text{V} \leq V_{IN} \leq 1.65\text{V}$	●	1.1850	1.200	1.2150	V
	$V_{OUT} = 1.5\text{V}$, $10\text{mA} \leq I_{OUT} \leq 2.5\text{A}$, $1.8\text{V} \leq V_{IN} \leq 1.95\text{V}$	●	1.4812	1.500	1.5188	V
	$V_{OUT} = 1.8\text{V}$, $10\text{mA} \leq I_{OUT} \leq 2.5\text{A}$, $2.1\text{V} \leq V_{IN} \leq 2.25\text{V}$	●	1.7775	1.800	1.8225	V
	$V_{OUT} = 2.5\text{V}$, $10\text{mA} \leq I_{OUT} \leq 2.5\text{A}$, $2.8\text{V} \leq V_{IN} \leq 2.95\text{V}$	●	2.4687	2.500	2.5313	V
Regulated Output Voltage Margining	MARGA = 1.2V	●	9	10	11	%
	MARGA = 0V	●	−11	−10	−9	%
Line Regulation to V_{IN}	$V_{OUT} = 0.6\text{V}$, $\Delta V_{IN} = 0.9\text{V}$ to 3.45V , $V_{BIAS} = 5.0\text{V}$, $I_{OUT} = 10\text{mA}$	●		0.02	1	mV
	$V_{OUT} = 1.2\text{V}$, $\Delta V_{IN} = 1.5\text{V}$ to 3.45V , $V_{BIAS} = 5.0\text{V}$, $I_{OUT} = 10\text{mA}$	●		0.02	2	mV
Line Regulation to V_{BIAS}	$V_{OUT} = 0.6\text{V}$, $\Delta V_{BIAS} = 2.375\text{V}$ to 5.25V , $V_{IN} = 0.9\text{V}$, $I_{OUT} = 10\text{mA}$	●		0.2	1.5	mV
	$V_{OUT} = 1.2\text{V}$, $\Delta V_{BIAS} = 2.4\text{V}$ to 5.25V , $V_{IN} = 1.5\text{V}$, $I_{OUT} = 10\text{mA}$	●		0.2	3	mV
Load Regulation $\Delta I_{OUT} = 10\text{mA}$ to 2.5A (Note 5)	$V_{BIAS} = 2.375\text{V}$, $V_{IN} = 0.9\text{V}$, $V_{OUT} = 0.6\text{V}$	●		1.2	2.4	mV
	$V_{BIAS} = 2.375\text{V}$, $V_{IN} = 1.3\text{V}$, $V_{OUT} = 1.0\text{V}$	●		2	4	mV
	$V_{BIAS} = 2.4\text{V}$, $V_{IN} = 1.5\text{V}$, $V_{OUT} = 1.2\text{V}$	●		1.3	2.5	mV
	$V_{BIAS} = 3\text{V}$, $V_{IN} = 2.1\text{V}$, $V_{OUT} = 1.8\text{V}$	●		1.9	3.7	mV
	$V_{BIAS} = 3.7\text{V}$, $V_{IN} = 2.8\text{V}$, $V_{OUT} = 2.5\text{V}$	●		2.6	5.1	mV
Minimum Load Current (Note 11)				1	mA	
Dropout Voltage $V_{IN} = V_{OUT(NOMINAL)}$ $V_{BIAS} \geq V_{OUT} + 1.2\text{V}$ (Note 8)	$I_{OUT} = 0.5\text{A}$	●		19	25	mV
	$I_{OUT} = 1\text{A}$	●		38	50	mV
	$I_{OUT} = 2.5\text{A}$	●		80	125	mV
				175	mV	

ELECTRICAL CHARACTERISTICS

The ● denotes the specifications which apply over the full operating temperature range, otherwise specifications are at $T_A = 25^\circ\text{C}$. $R_{MON} = 1\text{k}\Omega$, unless otherwise noted.

PARAMETER	CONDITIONS		MIN	TYP	MAX	UNITS
SENSE Pin Current (Note 5)	$V_{IN} = 0.9\text{V}$, $V_{OUT} = 0.6\text{V}$ (Unity Gain)	●	-1.5	0	1.5	μA
	$V_{IN} = 0.95\text{V}$, $V_{OUT} = 0.65\text{V}$	●	7	12.5	20	μA
	$V_{IN} = 1.45\text{V}$, $V_{OUT} = 1.15\text{V}$	●	82	137.5	215	μA
	$V_{IN} = 1.5\text{V}$, $V_{OUT} = 1.2\text{V}$ (Unity Gain)	●	-1.5	0	1.5	μA
	$V_{IN} = 2.1\text{V}$, $V_{OUT} = 1.8\text{V}$	●	90	150	235	μA
	$V_{IN} = 2.8\text{V}$, $V_{OUT} = 2.5\text{V}$	●	194	325	508	μA
Ground Pin Current (Both Channels Enabled) (Note 9)	$V_{IN} = 1.3\text{V}$, $V_{OUT} = 1.0\text{V}$, $I_{OUT1} = I_{OUT2} = 10\text{mA}$	●		2.6	5.2	mA
	$V_{IN} = 1.3\text{V}$, $V_{OUT} = 1.0\text{V}$, $I_{OUT1} = 10\text{mA}$, $I_{OUT2} = 2.5\text{A}$	●		3.2	6.4	mA
BIAS Pin Current, $V_{IN} = 1.3\text{V}$, $V_{OUT} = 1.0\text{V}$ (Note 4)	$I_{OUT} = 10\text{mA}$	●		2.8	4.7	mA
	$I_{OUT} = 100\text{mA}$	●		3.5	5.7	mA
	$I_{OUT} = 500\text{mA}$	●		4.6	7.3	mA
	$I_{OUT} = 1\text{A}$	●		5.3	8.4	mA
	$I_{OUT} = 2.5\text{A}$	●		7	10.8	mA
BIAS Pin Current in Dropout (Notes 4, 8)	$V_{BIAS} = 5.25\text{V}$, $I_{OUT} = 2.5\text{A}$	●			36	mA
BIAS Pin Nap Mode Current	$V_{BIAS} = 5.25\text{V}$, $EN = 0\text{V}$	●		1.4	2.4	mA
Reverse Output Current (Note 10) $EN = V_{BIAS}$	$V_{BIAS} = 2.375\text{V}$, $V_{IN} = 0\text{V}$, $V_{OUT} = 0.6\text{V}$	●		0.02	0.2	mA
	$V_{BIAS} = 5.25\text{V}$, $V_{IN} = 0\text{V}$, $V_{OUT} = 2.5\text{V}$	●		0.45	1	mA
I_{MON} Output Current	$I_{OUT} = 2.5\text{A}$, $V_{IN} - V_{OUT} = 0.3\text{V}$	●	791.7	833.3	875	μA
	$I_{OUT} = 0.5\text{A}$, $V_{IN} - V_{OUT} = 0.3\text{V}$	●	137.5	166.7	195.8	μA
Adjustable Current Limit (Notes 6)	$R_{MON} = 1\text{k}\Omega$	●	2.79	3.0	3.21	A
	$R_{MON} = 2\text{k}\Omega$	●	1.37	1.5	1.63	A
	$R_{MON} = 6\text{k}\Omega$	●	0.4	0.5	0.6	A
Internal Current Limit (Notes 6, 12)	$V_{IN} = 0.9\text{V}$, $V_{OUT} = 0\text{V}$	●		3.3	4.2	A
	$V_{IN} - V_{OUT} = 0.3\text{V}$, $\Delta V_{OUT} = 100\text{mV}$	●	2.8			A
PWRGD V_{OUT} Threshold	Percentage of $V_{OUT(\text{NOMINAL})}$, V_{OUT} Rising	●	90	93.5	97	%
	Percentage of $V_{OUT(\text{NOMINAL})}$, V_{OUT} Falling	●	85	88.5	92	%
PWRGD V_{OL}	$I_{PWRGD} = 200\mu\text{A}$ (Fault Condition)	●			100	mV
PWRGD V_{OH} Leakage	$V_{PWRGD} = V_{BIAS} = 5.25\text{V}$	●			1	μA
TEMP Voltage (Note 3)	$T_J = 25^\circ\text{C}$			0.25		V
	$T_J = 125^\circ\text{C}$			1.25		V
TEMP Error (Note 3)	$0^\circ\text{C} < T_J \leq 125^\circ\text{C}$		-0.09		0.09	V
V_{BIAS} Undervoltage Lockout	V_{BIAS} Rising	●		2.15	2.37	V
	V_{BIAS} Falling	●	1.75	2.05		V
V_{IN} Undervoltage Lockout	V_{IN} Rising	●	0.43	0.50	0.59	V
V_{IN} Undervoltage Lockout Hysteresis				0.08		V
$V_{IN} - V_{BIAS}$ Overvoltage Lockout	$EN = V_{BIAS} = 3.3\text{V}$, V_{IN} Rising	●	150		320	mV
	$EN = V_{BIAS} = 3.3\text{V}$, V_{IN} Falling	●	60		180	mV
$V_{IN} - V_{OUT}$ Servo Voltage: VIOC (Note 7)	$I_{OUT} = 10\text{mA}$, $V_{OUT} \geq 0.7\text{V}$	●	400	450	500	mV
	$I_{OUT} = 10\text{mA}$, $V_{OUT} \leq 0.65\text{V}$	●	400	450	550	mV
	$I_{OUT} = 2.5\text{A}$, $V_{OUT} \geq 0.7\text{V}$	●	250	300	370	mV
	$I_{OUT} = 2.5\text{A}$, $V_{OUT} \leq 0.65\text{V}$	●	250	300	420	mV
VIOC Maximum Output Current	$V_{IN} = V_{OUT} + 20\text{mV}$, VIOC Pin Sources Current	●	170	270	390	μA
	$V_{IN} = V_{OUT} + 900\text{mV}$, VIOC Pin Sinks Current	●	170	310	390	μA
VIOC Transconductance	$V_{IN} = V_{OUT} + 450\text{mV}$			0.88		mA/V
V_{IL} Input Threshold (Logic-0 State) V_{OUTB2} , V_{OUTB1} , V_{OUTB0}	Input Falling	●	0.27	0.33		V
V_{IZ} Input Range (Logic-Z State) V_{OUTB2} , V_{OUTB1} , V_{OUTB0}		●	0.45		0.66	V

ELECTRICAL CHARACTERISTICS The ● denotes the specifications which apply over the full operating temperature range, otherwise specifications are at $T_A = 25^\circ\text{C}$. $R_{MON} = 1\text{k}\Omega$, unless otherwise noted.

PARAMETER	CONDITIONS		MIN	TYP	MAX	UNITS
V_{IH} Input Threshold (Logic-1 State) V_{OUTB2} , V_{OUTB1} , V_{OUTB0}	Input Rising	●		0.86	1	V
Input Hysteresis V_{OUTB2} , V_{OUTB1} , V_{OUTB0}	V_{IL} Input Rising V_{IH} Input Falling			65 90		mV mV
Input Pin Current High V_{OUTB2} , V_{OUTB1} , V_{OUTB0}	$V_{IH} = V_{BIAS} = 5.25\text{V}$, Current Sinks Into Pin	●		17	26	μA
Input Pin Current Low V_{OUTB2} , V_{OUTB1} , V_{OUTB0}	$V_{IL} = 0\text{V}$, $V_{BIAS} = 5.25\text{V}$, Current Sources Out of Pin	●		13	20	μA
EN Pin Threshold	$V_{OUT} = \text{OFF to ON}$ $V_{OUT} = \text{ON to OFF}$	● ●	0.3	0.85 0.5	1.1	V V
EN Pin Logic—High Current	$V_{EN} = V_{BIAS} = 5.25\text{V}$	●	7	12	20	μA
EN Pin Logic—Low Current	$V_{EN} = 0\text{V}$	●			1	μA
V_{BIAS} Ripple Rejection (Note 4)	$V_{BIAS} = 2.7\text{V}$ (Avg), $V_{IN} = 1.5\text{V}$, $V_{OUT} = 1.2\text{V}$, $I_{OUT} = 2.5\text{A}$, $V_{RIPPLE} = 0.5\text{V}_{P-P}$, $f_{RIPPLE} = 120\text{Hz}$		54	70		dB
V_{IN} Ripple Rejection (Notes 4, 5, 6)	$V_{BIAS} = 2.5\text{V}$, $V_{IN} = 1.65\text{V}$ (Avg), $V_{OUT} = 1.2\text{V}$, $I_{OUT} = 2.5\text{A}$, $V_{RIPPLE} = 300\text{mV}_{P-P}$, $f_{RIPPLE} = 120\text{Hz}$		60	74		dB
Channel Isolation (Notes 4, 5, 6) (Opposing Channel V_{OUT} Ripple)	$V_{BIAS} = 2.5\text{V}$, $V_{IN} = 1.5\text{V}$, $V_{OUT} = 1.2\text{V}$, $I_{OUT1} = I_{OUT2} = 2.5\text{A}$, $V_{RIPPLE} = 50\text{mV}_{P-P}$, $f_{RIPPLE} = 120\text{Hz}$			80		dB
Output Voltage Noise (Note 4)	$V_{OUT} = 1.2\text{V}$, $I_{OUT} = 2.5\text{A}$, $C_{REF/BYP} = 100\text{nF}$, $BW = 10\text{Hz to } 100\text{kHz}$, $C_{OUT} = 10\mu\text{F}$			12		μV_{RMS}

Note 1: Stresses beyond those listed under Absolute Maximum Ratings may cause permanent damage to the device. Exposure to any Absolute Maximum Rating condition for extended periods may affect device reliability and lifetime.

Note 2: The LT3072 regulators are tested and specified under pulse load conditions such that $T_J = T_A$. The LT3072E is 100% tested at $T_A = 25^\circ\text{C}$ and performance is guaranteed from 0°C to 125°C . Performance at -40°C and 125°C is assured by design, characterization and correlation with statistical process controls. The LT3072I is guaranteed over the -40°C to 125°C operating junction temperature range.

Note 3: The TEMP output voltage represents the average temperature of the LT3072's power devices. Due to power dissipation, temperature gradients and thermal time constants across the die, the TEMP output voltage measurement is not guaranteed to precisely track transient power excursions in the power device. The internal thermal shutdown sensors, embedded in each power device, are designed to keep the LT3072 within its safe operating area.

Note 4: Electrical Test performed with both channels enabled, the channel under test at the specified load current and the other channel at 10mA.

Note 5: To maintain proper performance and regulation, the BIAS supply voltage must be higher than both IN supply voltages. For both V_{OUT} voltages, the BIAS voltage must satisfy the following conditions:

$$2.375\text{V} \leq V_{BIAS} \leq 5.25\text{V} \text{ and } V_{BIAS} \geq (V_{OUT} + 1.2\text{V}).$$

Note 6: Operating conditions are limited by maximum junction temperature. The regulated output voltage specification does not apply for all possible combinations of input voltage and output current. When operating at maximum output current, limit the input voltage range to $V_{IN} \leq V_{OUT} + 300\text{mV}$.

Note 7: VIOC input-to-output voltage control incorporates a power adaptive feature that maximizes V_{IN} under light loads at $V_{IN} - V_{OUT} = 450\text{mV}$, and reduces $V_{IN} - V_{OUT}$ to 300mV near max load.

Note 8: Dropout voltage, V_{DO} , is the minimum input-to-output voltage differential at a specified output current. In dropout, the output voltage equals $V_{IN} - V_{DO}$.

Note 9: GND pin current is tested with $V_{IN} = V_{OUT(NOMINAL)} + 300\text{mV}$ and a current source load.

Note 10: Reverse output current is tested with the IN pins grounded and the OUT + SENSE pins forced to the rated output voltage. This is measured as current into the OUT + SENSE pins.

Note 11: The LT3072 requires a minimum load current to ensure proper regulation and stability. This parameter is guaranteed by design and is not production tested.

TYPICAL PERFORMANCE CHARACTERISTICS

Dropout Voltage vs I_{OUT}

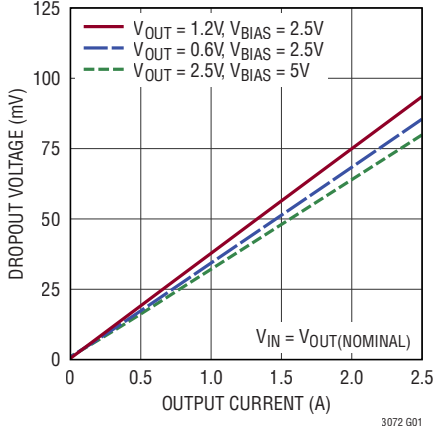

3072 G01

Dropout Voltage (2.5A)

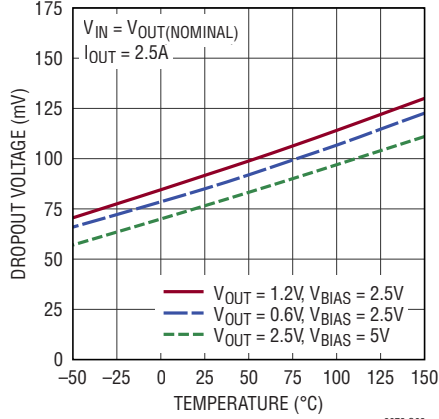

3072 G02

Dropout Voltage (1A)

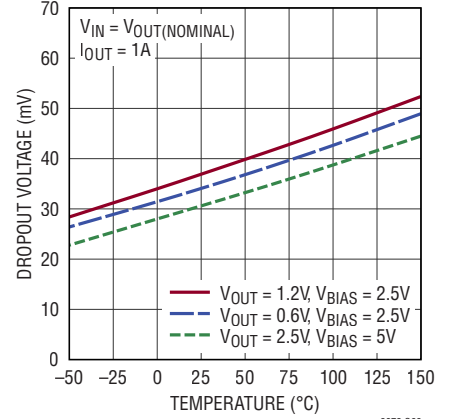

3072 G03

Dropout Voltage (0.5A)

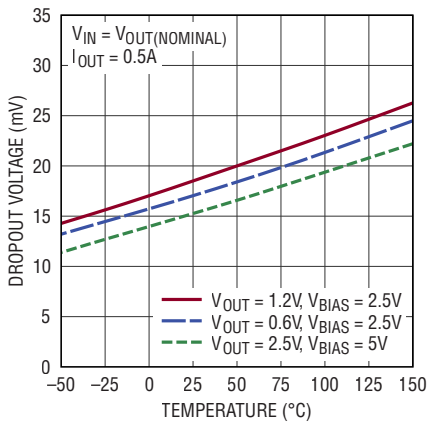

3072 G04

Dropout Voltage vs V_{BIAS}

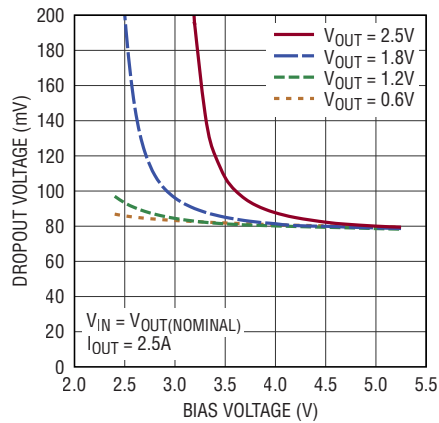

3072 G05

Output Voltage (0.6V)

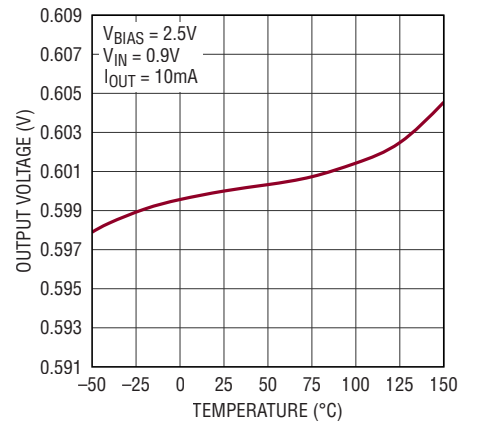

3072 G06

Output Voltage (1.0V)

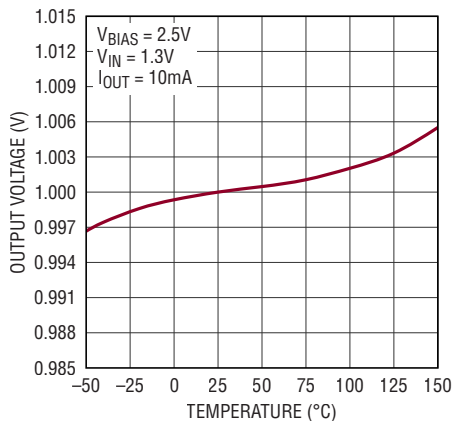

3072 G07

Output Voltage (1.2V)

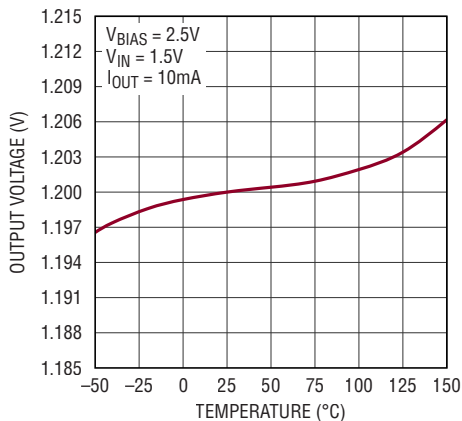

3072 G08

Output Voltage (1.5V)

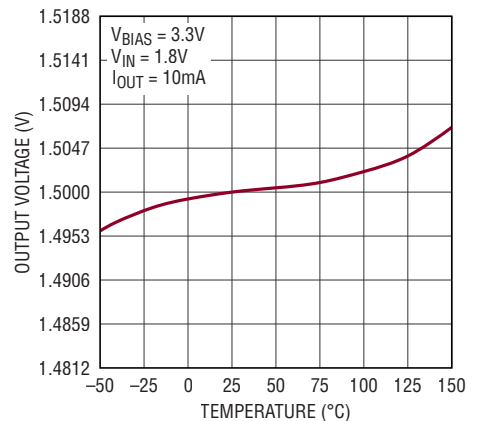

3072 G09

TYPICAL PERFORMANCE CHARACTERISTICS

Output Voltage (1.8V)

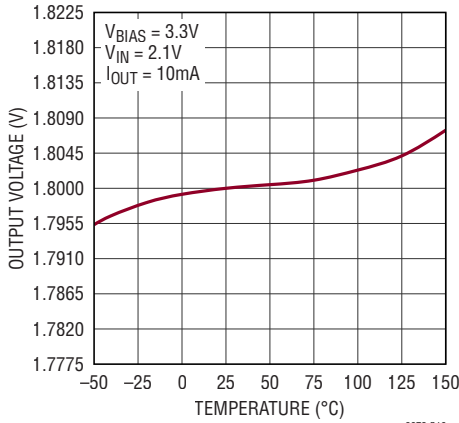

3072 G10

Output Voltage (2.5V)

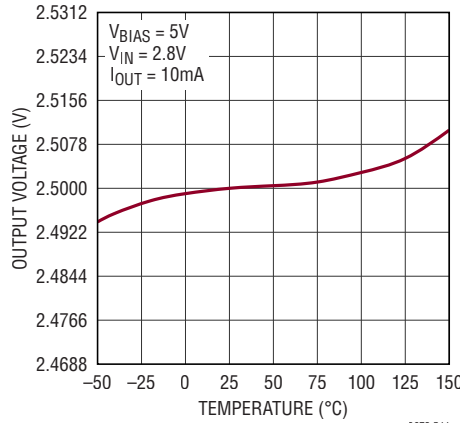

3072 G11

GND Pin Current vs IOUT

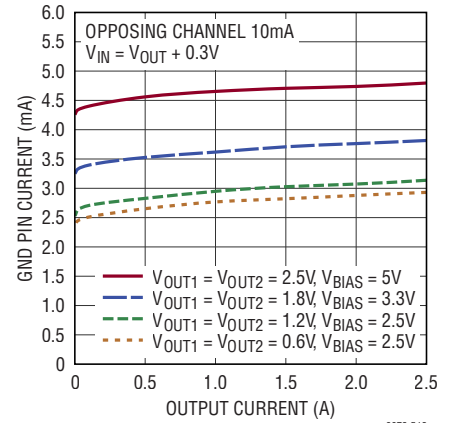

3072 G12

GND Pin Current

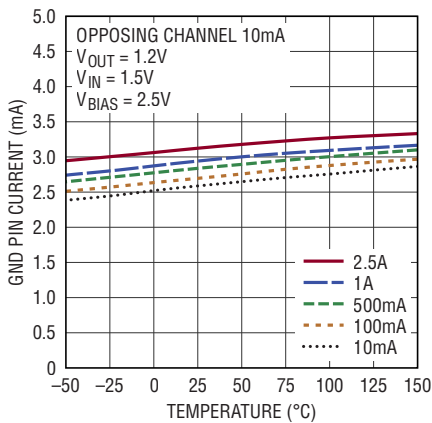

3072 G13

BIAS Pin Current in Nap Mode

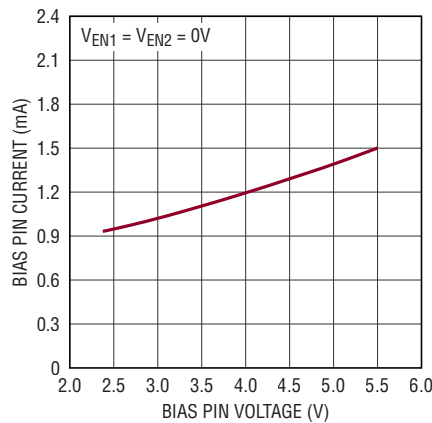

3072 G14

BIAS Pin Current in Nap Mode

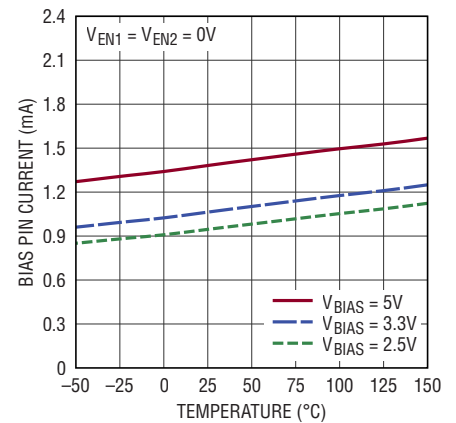

3072 G15

BIAS Pin Current vs IOUT

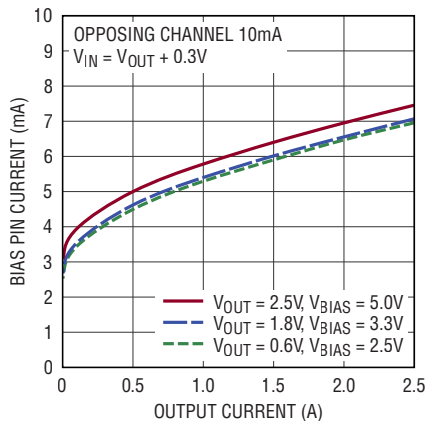

3072 G16

BIAS Pin Current

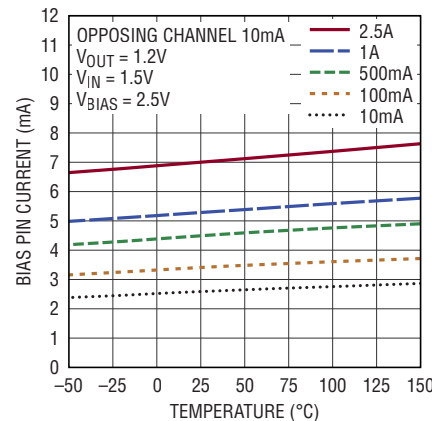

3072 G17

BIAS Pin Undervoltage Lockout Threshold

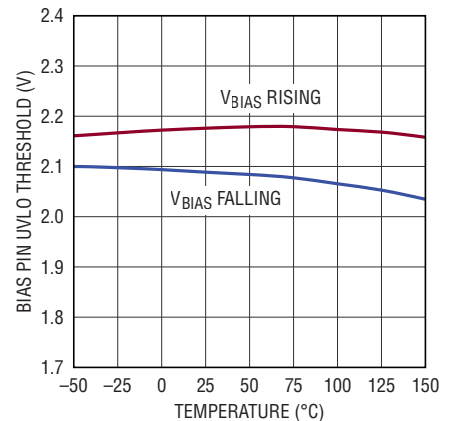

3072 G18

TYPICAL PERFORMANCE CHARACTERISTICS

IN Pin Undervoltage Lockout Threshold

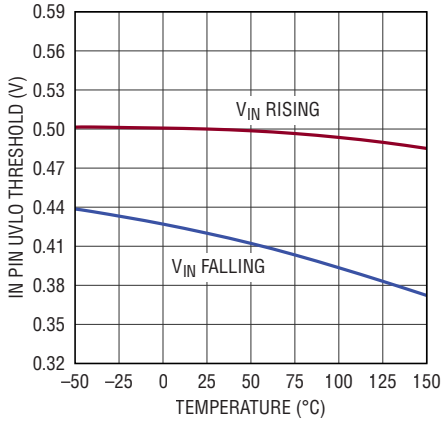

$V_{IN} - V_{BIAS}$ Overvoltage Lockout Threshold

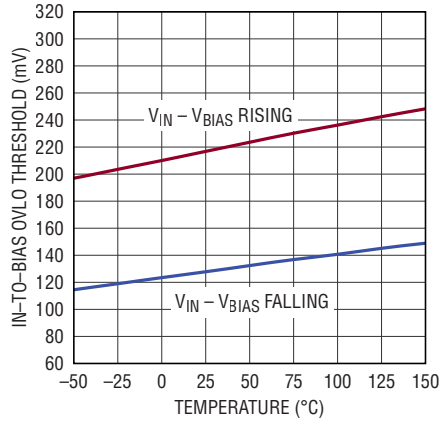

EN Pin Threshold

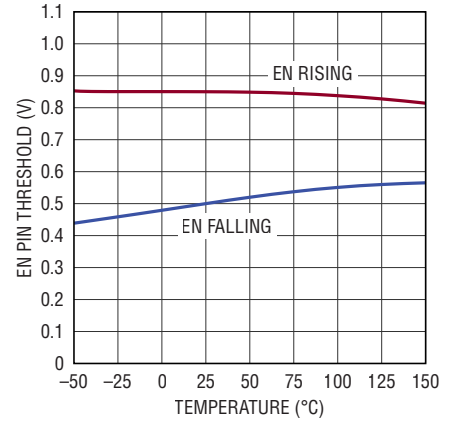

EN Pin Input Current

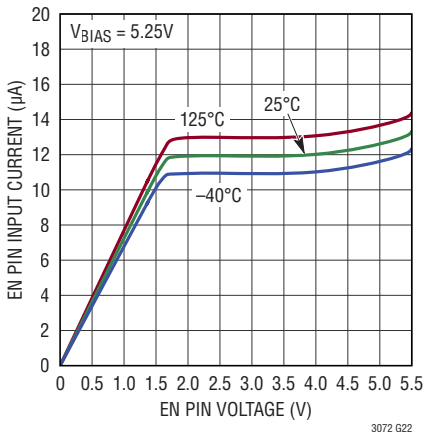

$V_{O1,2B0,1,2}$ Pin Thresholds

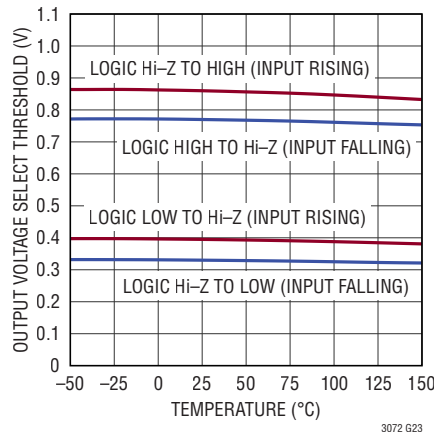

$V_{O1,2B0,1,2}$ Pin Input Current

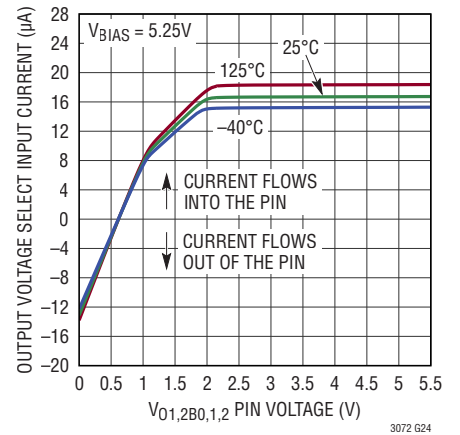

SENSE Pin Current

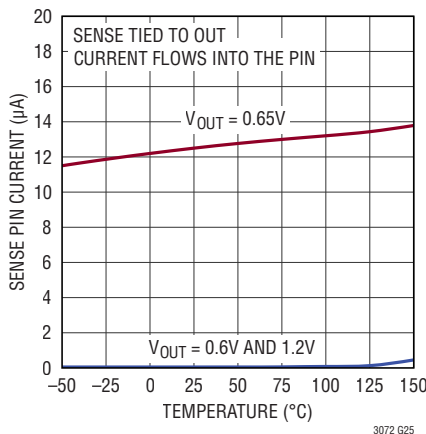

SENSE Pin Current

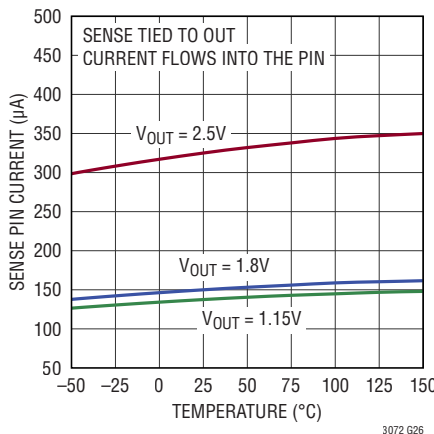

PWRGD Threshold

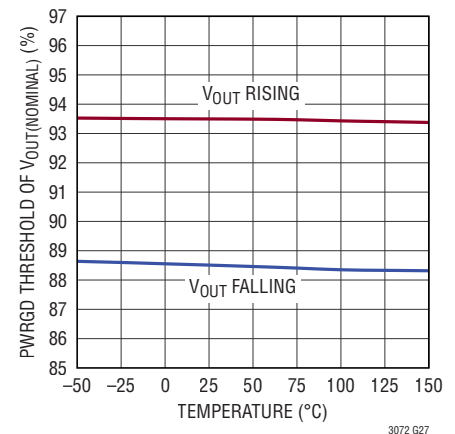

TYPICAL PERFORMANCE CHARACTERISTICS

PWRGD V_{OL} Threshold

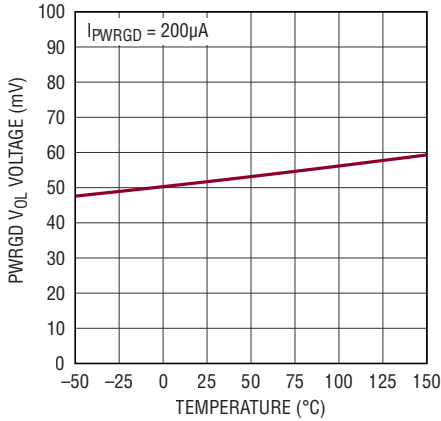

PWRGD Internal Time Delay

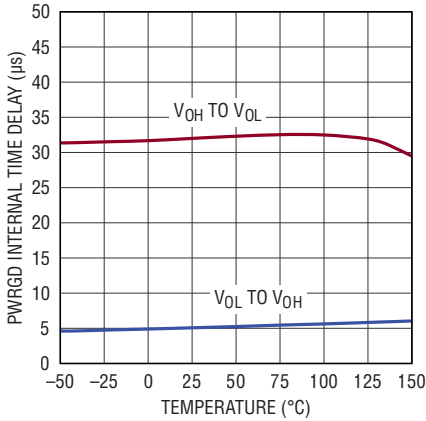

VIOC $V_{IN} - V_{OUT}$ Servo Voltage, $I_{OUT} = 10mA$

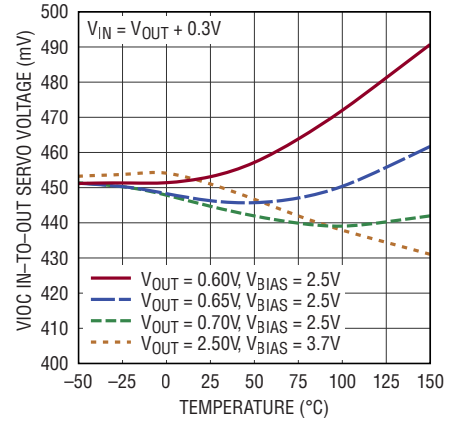

VIOC $V_{IN} - V_{OUT}$ Servo Voltage, $I_{OUT} = 2.5A$

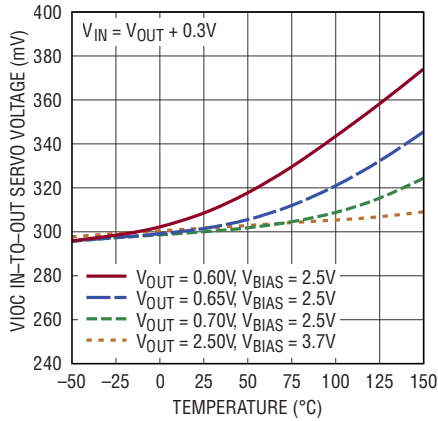

VIOC Output Current (Sourcing)

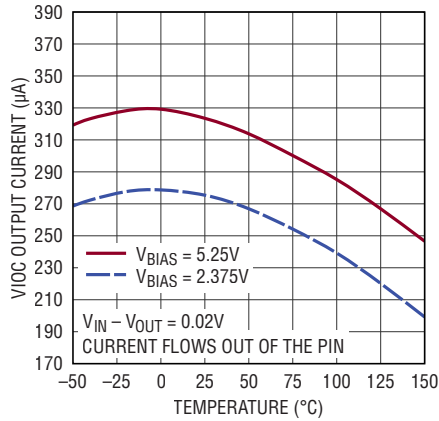

VIOC Output Current (Sinking)

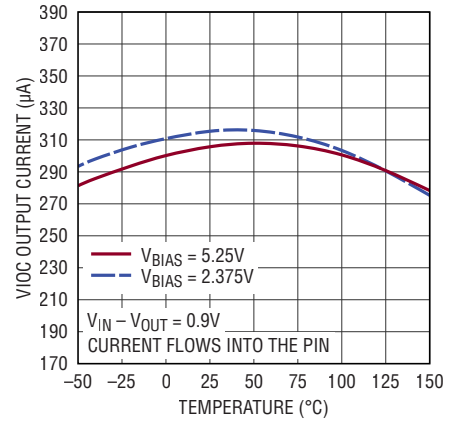

TEMP Pin Error

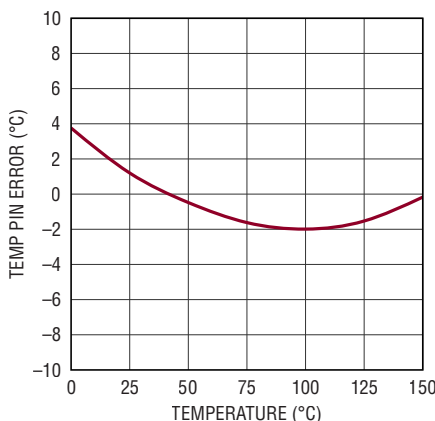

I_{OUT}/I_{MON} Ratio

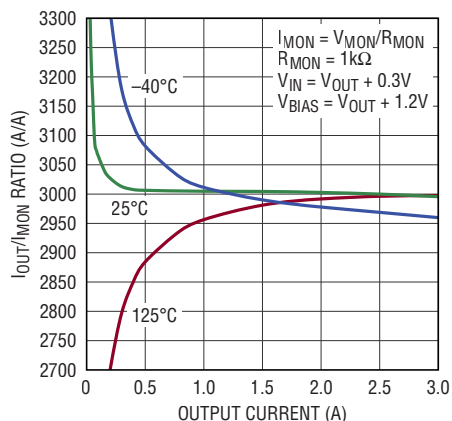

I_{MON}/I_{LM} External Current Limit Threshold

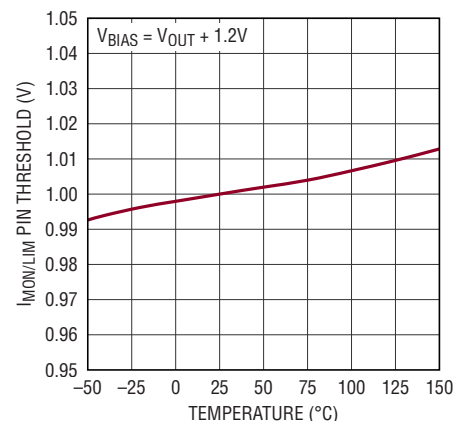

TYPICAL PERFORMANCE CHARACTERISTICS

Internal Current Limit

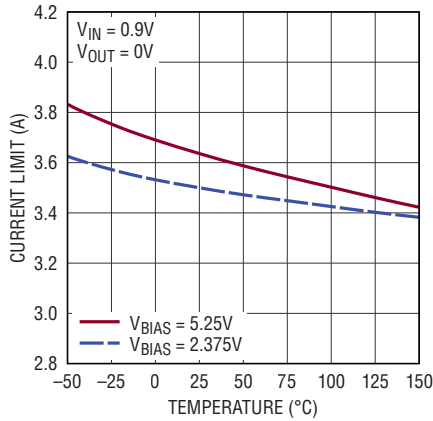

BIAS Pin Ripple Rejection, 1.2V/2.5A

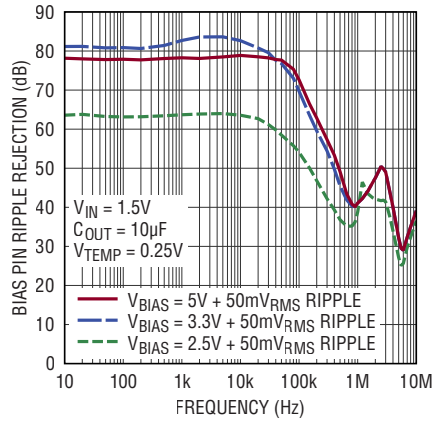

BIAS Pin Ripple Rejection vs $V_{BIAS} - V_{OUT}$, 1.2V/2.5A

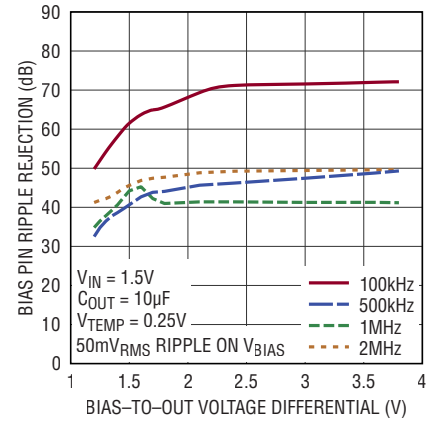

IN Pin Ripple Rejection, 1.2V/2.5A

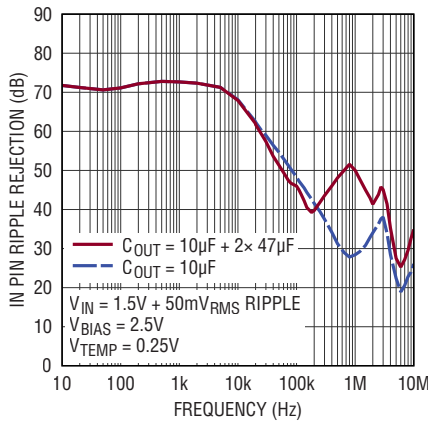

IN Pin Ripple Rejection, 1.2V/1A

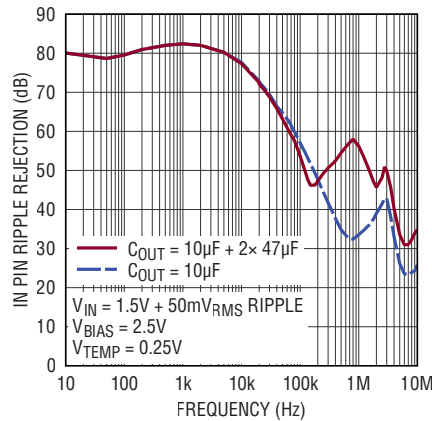

IN Pin Ripple Rejection vs $V_{IN} - V_{OUT}$, 1.2V/2.5A

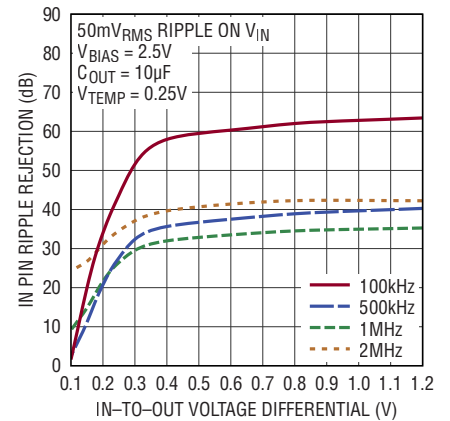

IN Pin Ripple Rejection vs $V_{IN} - V_{OUT}$, 1.2V/1A

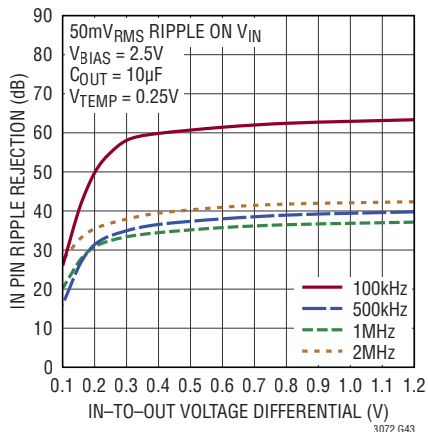

Channel-to-Channel Isolation

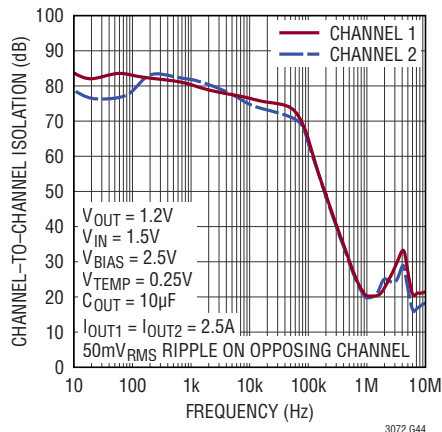

Minimum $V_{BIAS} - V_{OUT}$ Voltage

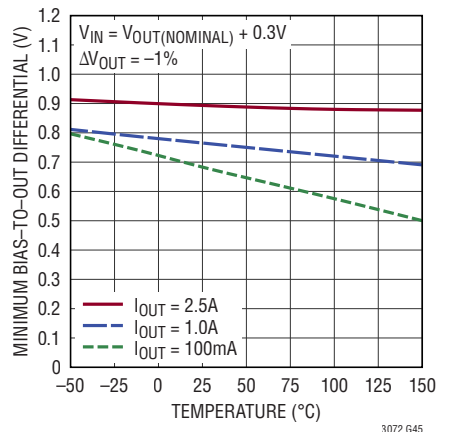

TYPICAL PERFORMANCE CHARACTERISTICS

Load Regulation

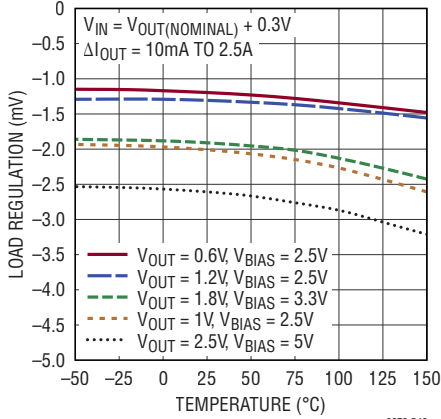

Line Regulation to V_{BIAS}

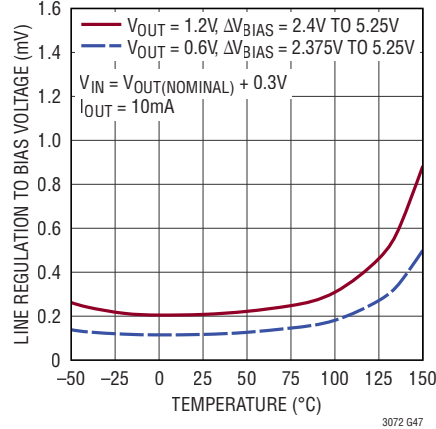

Line Regulation to V_{IN}

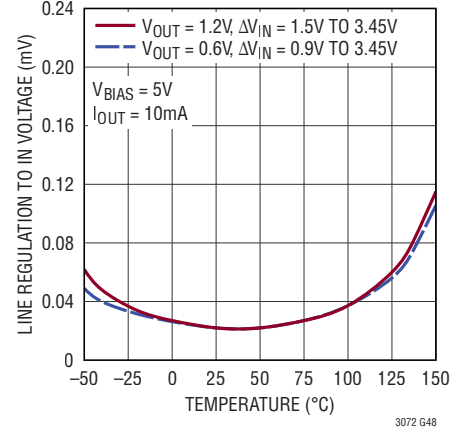

Reverse Output Current (0.6V)

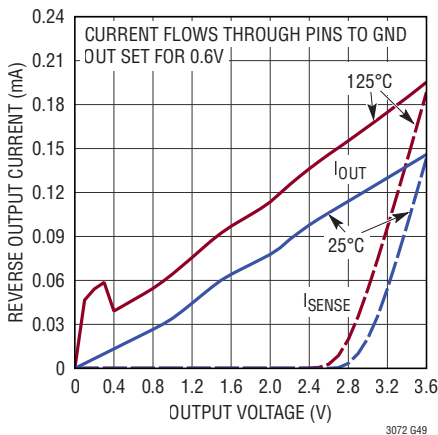

Reverse Output Current (2.5V)

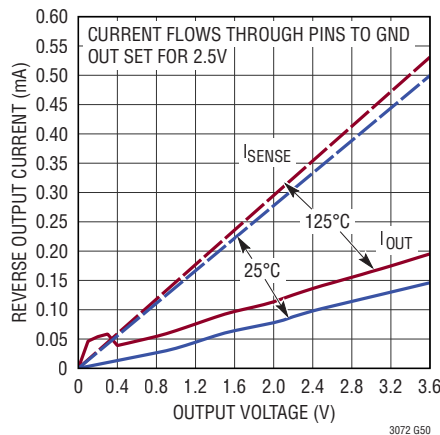

Output Noise Spectral Density vs V_{OUT}

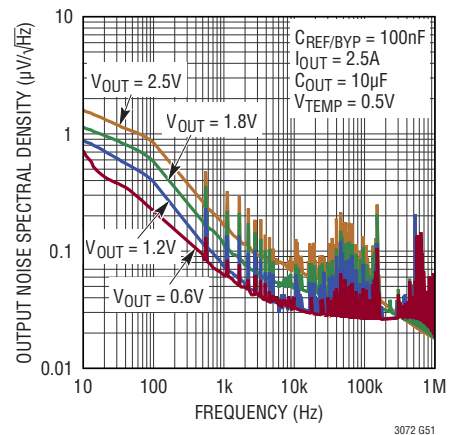

Output Noise Spectral Density vs $C_{REF/BYP}$

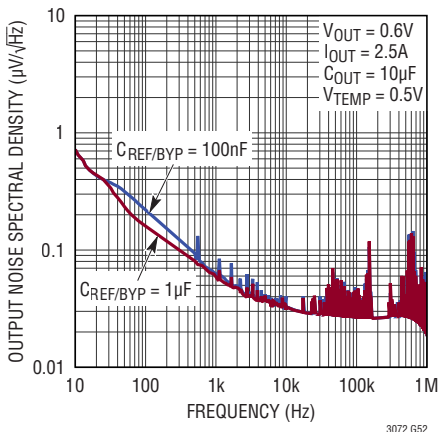

RMS Output Noise vs Load Current $C_{REF/BYP} = 100nF$

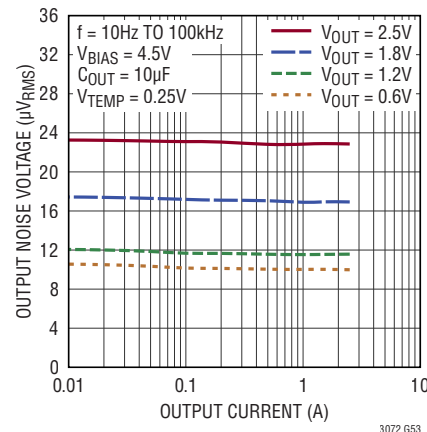

RMS Output Noise vs $C_{REF/BYP}$

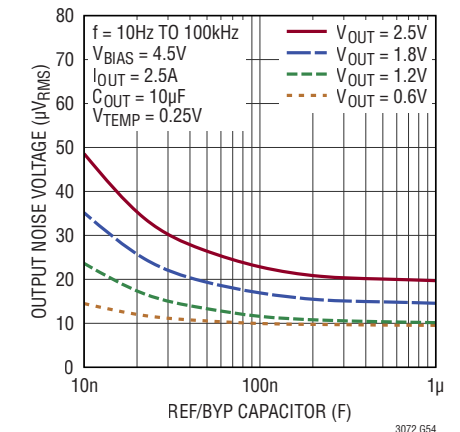

TYPICAL PERFORMANCE CHARACTERISTICS

Output Voltage Noise

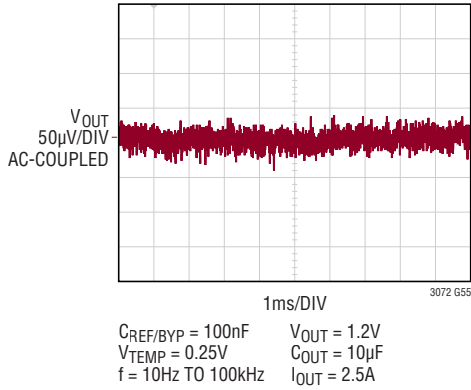

Start-Up Time

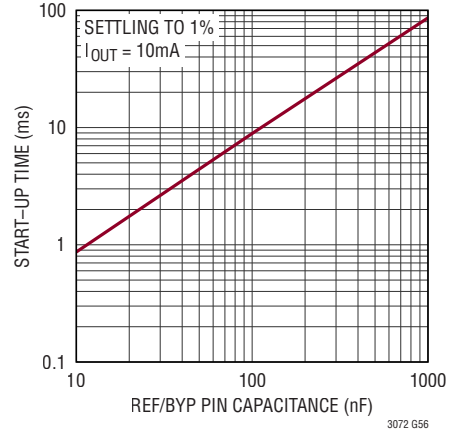

Start-Up Response

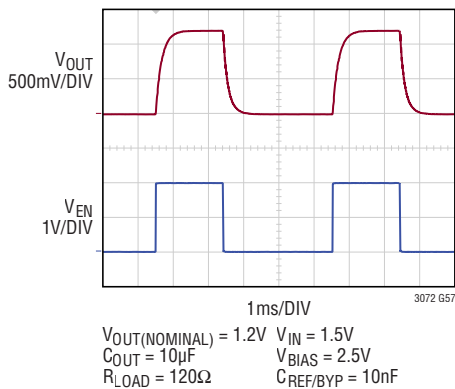

Load Transient Response

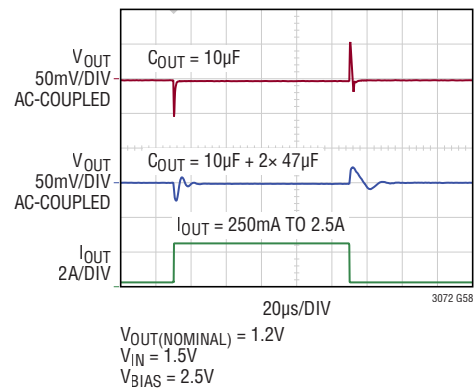

VIN Line Transient Response

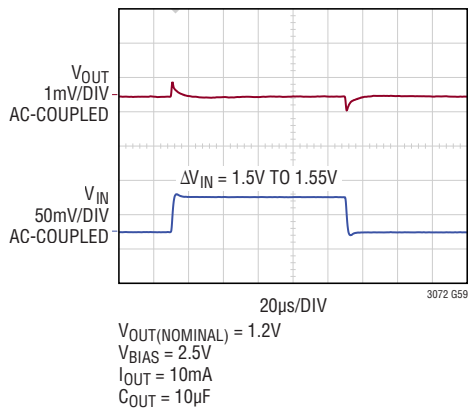

VBIAS Line Transient Response

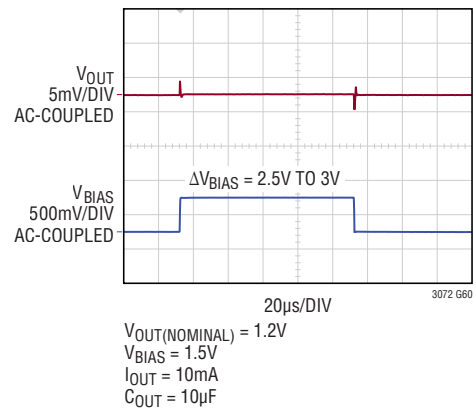

PIN FUNCTIONS

V_{01,2B0}, V_{01,2B1} and V_{01,2B2} (Pins 34, 15, 35, 14, 36, 13): Output Voltage Select. These three-state pins combine to select a nominal output voltage from 0.6V to 2.5V. An input logic low state is guaranteed with less than 270mV referenced to GND and a logic high state is guaranteed with greater than 1V referenced to GND. The range between 0.45V and 0.66V defines the logic Hi-Z (input floating) state. See Table 1 in the Applications Information section that defines the V_{OUT} versus V_{OB2}, V_{OB1} and V_{OB0} settings.

EN1, EN2 (Pins 1, 12): Channel Enable. These pins enable/disable the channel output. Pulling the EN pin low pulls down the channel reference, and disables the output transistor and auxiliary functions. When disabled, the output is shunted to GND via the nominal feedback resistor network and an internal 32k load resistor. When V_{BIAS} is above its UVLO threshold, an additional 8k load resistor will be present on either IN or OUT, whichever has the lower voltage. Drive the EN pin with either a digital logic port or an open-collector NPN or an open-drain NMOS terminated with a pull-up resistor to V_{BIAS}. The pull-up resistor must be less than 182kΩ to meet the V_{IH} condition of the EN pin.

BIAS (Pins 2, 11): Bias Supply. These pins supply current to most of the internal control circuitry and the output stage driving the pass transistor. The LT3072 requires a minimum 2.2μF bypass capacitor on each BIAS pin for stability and proper operation. To ensure proper operation, the BIAS voltage must conform to the equation:

$$V_{OUT} + 1.2V \leq V_{BIAS} \leq 5.25V$$

Both BIAS pins must be tied together on the PCB. Power sequence BIAS first before toggling the enable and output voltage select pins.

PWRGD1, PWRGD2 (Pins 3, 10): Power Good. The PWRGD pins are open-drain NMOS outputs that are active low when the channel is enabled and any one of these fault modes is detected:

- V_{OUT} is less than 93.5% of V_{OUT(NOMINAL)} on the rising edge of V_{OUT}.
- V_{OUT} drops below 88.5% of V_{OUT(NOMINAL)} for more than 35μs.

- V_{BIAS} is less than its undervoltage lockout threshold.
- V_{IN} is less than its undervoltage lockout threshold.
- V_{IN} is greater than V_{BIAS} by more than its overvoltage lockout threshold.
- The OUT-over-IN voltage detector is activated.
- V_{BIAS} is less than 1V higher than V_{OUT} and V_{IN}.
- Thermal shutdown is triggered.

See the Applications Information section for more information on PWRGD fault modes.

VIOC1, VIOC2 (Pins 4, 9): Voltage for IN-to-OUT Control. VIOC is a unique tracking function to control a buck regulator powering the LT3072 input. The VIOC pin is the output of this tracking function that drives an external buck regulator to maintain the input voltage at V_{OUT} + 300mV at maximum load and V_{OUT} + 450mV at light load, or a minimum of 0.85V, whichever is greater. This function maximizes efficiency and minimizes power dissipation. See the Applications Information section for more information on proper control of the buck regulator.

When not used, terminate the VIOC pin to GND with a small capacitor (1nF) to avoid oscillations. The VIOC pin can be tied to GND if additional quiescent current is not a concern during low input-to-output voltage differential conditions.

IN1, IN2 (Pins 5, 6, 7, 8): Input Supply. These pins supply power to the high current pass transistor. Tie both IN1 pins together and both IN2 pins together for proper performance. The LT3072 requires a bypass capacitor at IN to maintain stability and low input impedance over frequency. A 22μF input bypass capacitor on each channel suffices for most battery and power plane impedances. Minimizing input trace inductance optimizes performance. Applications that operate with low V_{IN}-V_{OUT} differential voltages with large, fast load transients will have much higher input capacitor requirements to prevent the input supply from drooping and allowing the regulator to enter dropout. See the Applications Information section for more information on input capacitor requirements.

NC: (Pin 16): Unused Pin in the Package. Connect to ground or any adjacent pin.

PIN FUNCTIONS

GND: (Pins 20, 21, 28, 29, Exposed Pad 37): Ground. The exposed pad is an electrical connection to GND. To ensure proper electrical and thermal performance, solder the back tab to the PCB ground and tie to all GND pins of the package. These GND pins are fused to the internal die attach paddle and the exposed pad to optimize heat sinking and thermal resistance characteristics. See the Applications Information section for thermal considerations and calculating junction temperature.

OUT1, OUT2 (Pins 25, 26, 23, 24): Output. These pins supply power to the load. Tie both OUT1 pins together and both OUT2 pins together for proper performance. A minimum output capacitance of 10 μ F is required for stability. ADI recommends low ESR, X5R or X7R dielectric ceramic capacitors for best performance. Large load transient applications require larger output capacitors to limit peak voltage transients. **The LT3072 requires a 1mA minimum load current to ensure proper regulation and stability.**

See the Applications Information section for more information on output capacitor requirements.

SENSE1, SENSE2 (Pins 27, 22): Kelvin Sense for OUT. Optimum regulation is obtained when the SENSE pin connects to the OUT pin of the regulator. In critical applications, the resistance (R_P) of PCB traces between the regulator and the load cause small voltage drops, creating a load regulation error at the point of load. Connecting the SENSE pin at the load instead of directly to OUT eliminates this voltage error. Figure 1 illustrates this Kelvin-Sense connection method. Note that the voltage drop across the external PCB traces adds to the dropout voltage of the regulator. The SENSE pin input bias current depends on the selected output voltage. SENSE pin input current varies from 12.5 μ A typical at $V_{OUT} = 0.65V$, to 325 μ A typical at $V_{OUT} = 2.5V$.

REF/BYP1, REF/BYP2 (Pins 30, 19): Reference Filter. This pin is the output of a 66.7 μ A current reference feeding an impedance of approximately 18k Ω . This pin must not be externally loaded. Bypassing the REF/BYP pin to GND with at least a 10nF capacitor filters the chopper stabilized reference, decreases output voltage noise and provides a

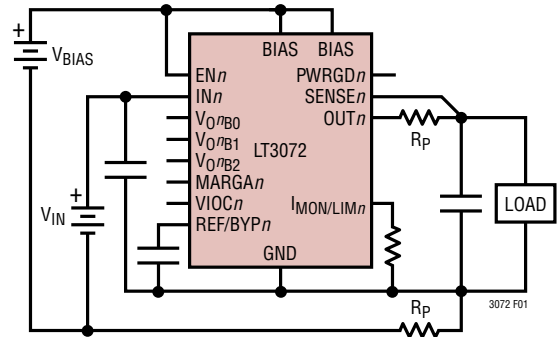

Figure 1. Kelvin Sense

soft-start function to each channel reference. ADI recommends the use of a high quality, low leakage capacitor. See the Applications Information section for related information about output noise and output voltage margining.

MARGA1, MARGA2 (Pins 31, 18): Analog Margining. This input pin selects the value of margining by injecting offset into the internal reference. Grounding this pin will offset the channel output by -10%. Pulling this pin to 1.2V will offset the output by 10%. Note: the 1.2V REF/BYP pin will not drive the MARGA pin to 10%. An external reference is required.

TEMP (Pin 33): Output indicator of average die temperature scaled at 10mV/ $^{\circ}C$ to a reference level of 0.25V at 25 $^{\circ}C$. The TEMP output is active when V_{BIAS} is above its undervoltage lockout threshold. Since the TEMP pin output impedance is typically 1k Ω , use a resistor divider greater than 100k Ω for applications requiring the attenuation of the TEMP pin voltage.

IMON/LIM1, IMON/LIM2 (Pins 32, 17): Output Current Monitor and Adjustable Current Limit Pin. When the channel is enabled, this pin sources an output current proportional to the channel load current scaled to 333.3 μ A per 1A load current. Current limit activates when this pin rises to 1V. $I_{LIM} = 3000/R_{MON}$ where R_{MON} is the terminating resistor to ground. When current limiting to less than 500mA, a series 10k – 10nF network on the IMON/LIM pin will compensate the presence of parasitic series inductance to the load.

BLOCK DIAGRAM

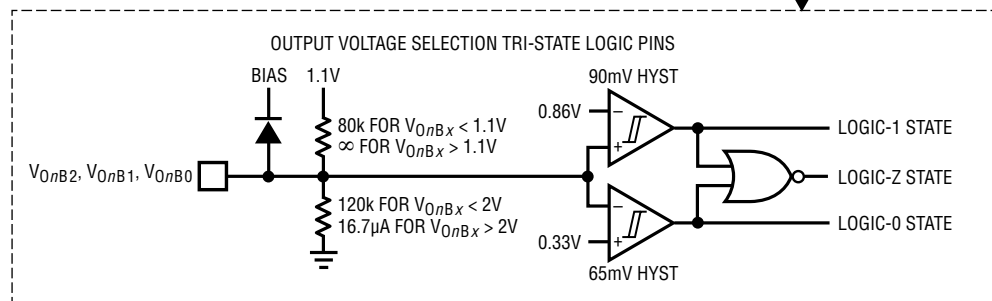
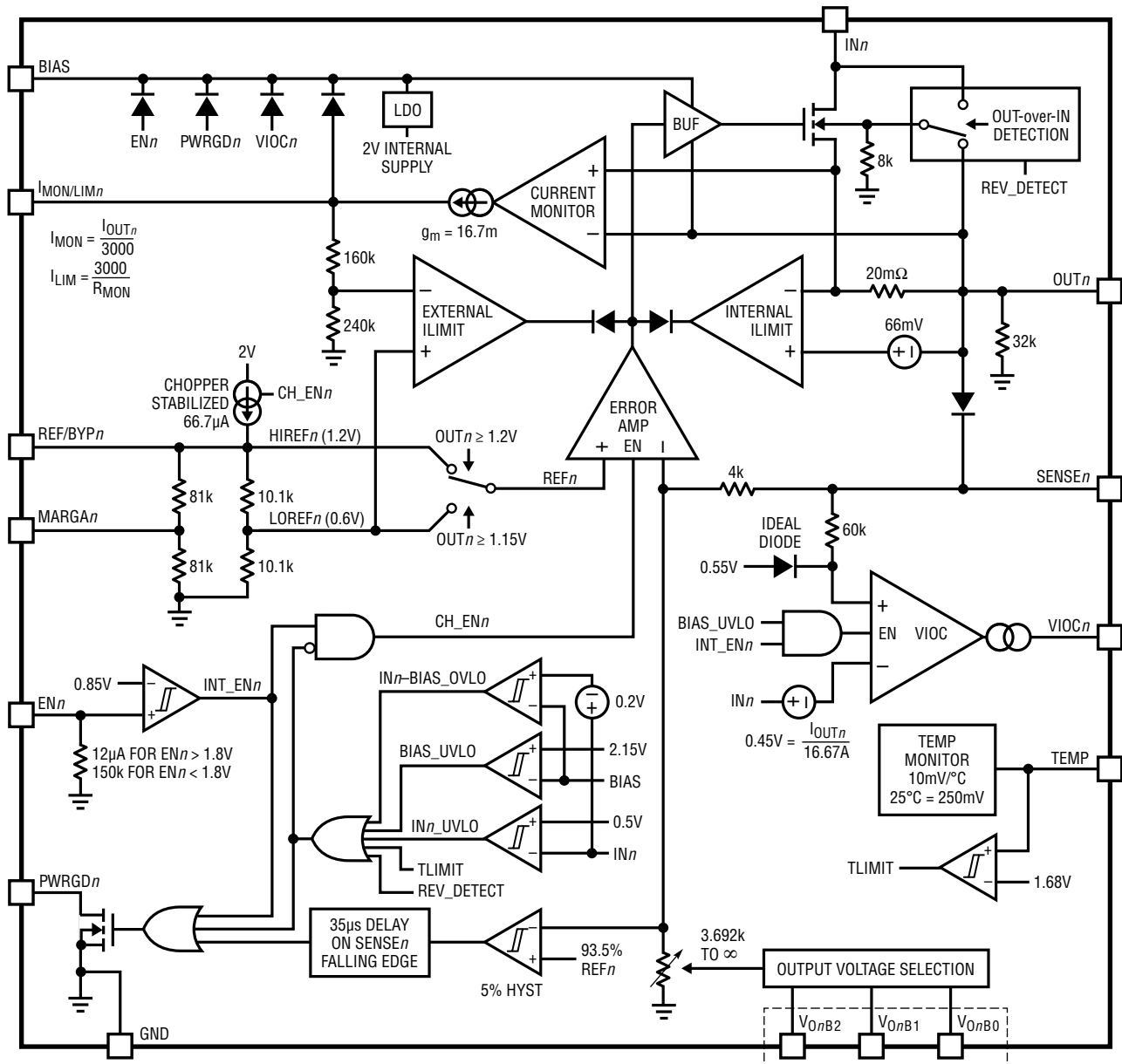

3072 BD02

APPLICATIONS INFORMATION

Introduction

Current generation FPGA and ASIC processors place stringent demands on the power supplies that power the core, I/O, and transceiver channels. These microprocessors may cycle load current from near zero to amps in nanoseconds. Output voltage specifications, especially in the 1V range, require tight tolerances including transient response as part of the requirement. Some ASIC processors require only a single output voltage from which the core and I/O circuitry operate. Some high performance FPGA processors require separate power supply voltages for the processor core, the I/O and the transceivers. Often, these supply voltages must be low noise and high bandwidth to achieve the lowest bit-error rates. These requirements mandate the need for very accurate, low noise, high current, very high speed regulator circuits that operate at low input and output voltages.

The LT3072 is a dual channel, low voltage, UltraFast transient response linear regulator. The device supplies up to 2.5A of output current per channel with a typical drop-out voltage of 80mV. A 0.1 μ F reference bypass capacitor decreases output noise to 12 μ V_{RMS} (BW = 10Hz to 100kHz). The LT3072's high bandwidth provides UltraFast transient response using low ESR ceramic output capacitors (10 μ F minimum), saving bulk capacitance, PCB area and cost.

The LT3072 features permit state-of-the-art linear regulator performance. The LT3072 is ideal for high performance FPGAs, microprocessors, sensitive communication supplies and high current logic applications that also operate over low input and output voltages.

The LT3072 provides dedicated control pins for both channels. Output voltage is digitally selectable in 50mV increments over the 0.6V to 1.2V range and 100mV increments over the 1.2V to 2.5V range. An analog margining pin allows the user to check system tolerance to the LT3072 output voltage continuously over a range of $\pm 10\%$. The LT3072 also incorporates enable/disable control.

The IC incorporates a unique tracking function, which if enabled by the user, controls the upstream regulator powering the LT3072 input (see Figure 2). This tracking function drives the buck regulator to maintain the LT3072

input voltage to $V_{OUT} + 450\text{mV}$ under light loads and $V_{OUT} + 300\text{mV}$ near maximum load. This input-to-output voltage control allows the user to change the LT3072 programmed output voltage, and have the switching regulator powering the LT3072 input track to the optimum input voltage with no component changes. Adapting for load current allows for the reduction in input capacitance requirements. This combines the efficiency of a switching regulator with superior linear regulator response. It also permits thermal management of the system even with a maximum 2.5A output load.

FPGA system designers can now correlate their power estimates with direct measurements of load current through the $I_{MON/LIM}$ pin. This feature provides 333.3 μ A per 1A of load current as a scaled dynamic representation of output current. A termination resistor programs the precision current limit to when the $I_{MON/LIM}$ pin voltage reaches 1V.

The LT3072 provides temperature monitoring that is typically 10mV/ $^{\circ}\text{C}$ where 250mV = 25 $^{\circ}\text{C}$. Additional LT3072 internal protection includes input undervoltage lockout (UVLO), reverse current protection, current limit and thermal shutdown. The LT3072 regulator is available in a thermally enhanced 36-lead, 4mm \times 7mm QFN package.

The LT3072 architecture drives an internal N-channel power MOSFET as a source follower. This configuration permits a user to realize an extremely low dropout, UltraFast transient response regulator with excellent high frequency PSRR performance. The LT3072 achieves superior regulator bandwidth and transient load performance and eliminates expensive bulk tantalum or electrolytic capacitors, even in the most modern and demanding microprocessor applications. Users realize significant cost savings as all additional bulk capacitance is removed. The additional savings of insertion cost, purchasing/inventory cost and board space is readily apparent. Precision incremental output voltage control accommodates legacy or future microprocessor power supply voltages.

Often, the high frequency ceramic decoupling capacitors required by these various FPGA and ASIC processors are sufficient to stabilize the system (see Stability and Output Capacitance section). This regulator design

APPLICATIONS INFORMATION

provides ample bandwidth and responds to transient load changes in a few hundred nanoseconds versus regulators that respond in many microseconds.

As lower voltage applications become increasingly prevalent with higher frequency switching power supplies, the LT3072 offers superior regulation and an appreciable component cost savings. The LT3072 steps to the next level of performance for the latest generation FPGAs, DSPs and microprocessors. The simple versatility and benefits derived from these circuits satisfy the power supply needs of today's high performance microprocessors.

Programming Output Voltage

Three tri-level input pins, V_{0nB2} , V_{0nB1} and V_{0nB0} , select the value of output voltage. Table 1 illustrates the three-bit digital word to output voltage relationship resulting from setting these pins high, low or allowing them to float.

An input logic *low* state is guaranteed with less than 270mV referenced to GND and a logic *high* state is guaranteed with greater than 1V. The range between 450mV to 660mV defines the logic *Hi-Z* (input floating) state.

These pins may be tied high by either pin strapping them to V_{BIAS} or driving them with digital ports. Pins that float may either actually float or require logic that has Hi-Z output capability. This allows output voltage to be dynamically changed if necessary.

Table 1. V_{OUT} Selection Matrix

V_{OUTn} (V)	V_{0nB2}	V_{0nB1}	V_{0nB0}
0.60	0	0	0
0.65	0	0	Z
0.70	0	0	1
0.75	0	Z	0
0.80	0	Z	Z
0.85	0	Z	1
0.90	0	1	0
0.95	0	1	Z
1.00	0	1	1
1.05	Z	0	0
1.10	Z	0	Z
1.15	Z	0	1
1.20	Z	Z	0
1.30	Z	Z	Z
1.40	Z	Z	1
1.50	Z	1	0
1.60	Z	1	Z
1.70	Z	1	1
1.80	1	0	0
1.90	1	0	Z
2.00	1	0	1
2.10	1	Z	0
2.20	1	Z	Z
2.30	1	Z	1
2.40	1	1	0
2.50	1	1	Z
2.50	1	1	1

0 = Low, Z = Hi-Z (Float), 1 = High

APPLICATIONS INFORMATION

REF/BYP—Voltage Reference

The REF/BYP pin is the buffered output of the internal 66.7 μ A current reference feeding an impedance of approximately 18k Ω . The internal reference is chopper stabilized at 125kHz with spread spectrum. A 100nF REF/BYP capacitor to GND creates a low pass pole at 88Hz, which decreases reference voltage noise to about 5 μ V_{RMS} and soft-starts the individual channel references at enable. Soft-start time is determined by the value of REF/BYP capacitor used. Output voltage noise is predominantly the RMS sum of the reference voltage noise in addition to the amplifier noise.

The REF/BYP pin must not be DC loaded by anything except for applications that parallel other LT3072 regulators for higher output currents. Consult the Paralleling for Higher Output Current section for further details.

Output Voltage Margining

An analog input pin, MARGA, selects the amount of output voltage margining. Margining is employed by offsetting the internal reference and likewise the output. Grounding the MARGA pin offsets the output -10%. Pulling the MARGA pin up to 1.2V offsets the output 10%.

Enable Function—Turning On and Off

The EN pins enable/disable the output and reset the independent channel references. Pulling both EN pins low places the regulator into “nap” mode. In nap mode, the internal overhead circuits remain active, but the outputs are disabled and the quiescent current decreases.

Drive the EN pins with either a digital logic port or an open-collector NPN or open-drain NMOS terminated with a pull-up resistor to V_{BIAS} . The pull-up resistor must be no larger than 182k to meet the V_{IH} condition of the EN pin when BIAS is at its minimum voltage of 2.375V.

BIAS Undervoltage Lockout

An internal undervoltage lockout (UVLO) comparator monitors the BIAS rail. If V_{BIAS} drops below the UVLO threshold, all functions shut down, the pass transistors are gated off and output currents fall to zero. The typical

BIAS pin UVLO threshold is 2.15V on the rising edge of V_{BIAS} . The UVLO circuit incorporates about 100mV of hysteresis on the falling edge of V_{BIAS} .

V_{IN} Undervoltage and Overvoltage Lockout

Each channel has input undervoltage and overvoltage lockout comparators. One monitors IN relative to a 500mV reference. The second monitors if IN exceeds V_{BIAS} . If either of these conditions are violated, the affected channel shuts down, the pass transistor is gated off and output current falls to zero.

High Efficiency Linear Regulator—Input-to-Output Voltage Control

The VIOC (voltage input-to-output control) pin is a function to control a switching regulator and facilitate a design solution that maximizes system efficiency at high load currents and still provides low dropout voltage performance.

The VIOC pin is the output of an integrated transconductance amplifier that sources 270 μ A and sinks 310 μ A of current. It typically regulates the output of most ADI switching regulators or LTM power modules by sinking current from the ITH compensation node. The VIOC function controls a buck regulator powering the LT3072 input by maintaining the LT3072 input voltage to $V_{OUT} + 450\text{mV}$ under light loads, and scaling back the input voltage to $V_{OUT} + 300\text{mV}$ at maximum load. This V_{IN} - V_{OUT} differential voltage scale is chosen to provide fast transient response and good high frequency PSRR while minimizing power dissipation and maximizing efficiency. For example, 1.5V to 1.2V conversion and 1.3V to 1.0V conversion yield 0.75W maximum power dissipation per channel at 2.5A full output current. The minimum input voltage that the VIOC pin will regulate to is 0.85V typically.

Figure 2 depicts that the switcher’s feedback resistor network sets the maximum switching regulator output voltage if the linear regulator is disabled. However, once the LT3072 is enabled, the feedback loop decreases the switching regulator output voltage back to $V_{OUT} + 450\text{mV}$ at light load.

Using the VIOC function creates a feedback loop between the LT3072 and the switching regulator. As such, the

APPLICATIONS INFORMATION

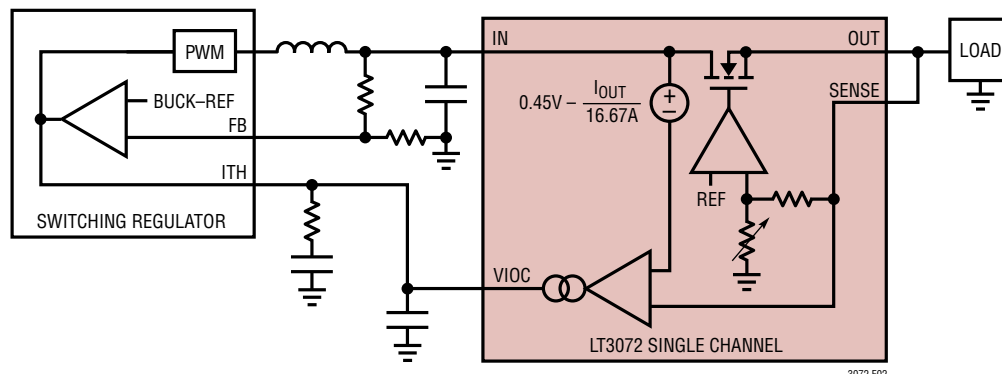

Figure 2. VIOC Control Block Diagram

feedback loop must be frequency compensated for stability. Fortunately, the connection of VIOC to many ADI ITH pins represents a high impedance characteristic which is the optimum circuit node to frequency compensate the feedback loop. Figure 2 illustrates the typical frequency compensation network used at the VIOC node to GND.

Power Good

PWRGD pin is an open-drain NMOS digital output that actively pulls low if any one of these fault modes is detected:

- V_{OUT} is less than 93.5% of $V_{OUT(NOMINAL)}$ on the rising edge of V_{OUT} .
- V_{OUT} drops below 88.5% of $V_{OUT(NOMINAL)}$ for more than 35 μ s.
- V_{BIAS} is less than its undervoltage lockout threshold.
- V_{IN} is less than its undervoltage lockout threshold.
- V_{IN} is greater than V_{BIAS} by more than its overvoltage lockout threshold.
- The OUT-over-IN voltage detector activates.
- Junction temperature exceeds 168°C typically.

Stability and Output Capacitance

The LT3072 feedback loop requires a minimum output capacitance of 10 μ F for stability. ADI recommends mounting low ESR, X5R or X7R ceramic capacitors in close proximity to the LT3072 OUT and GND pins. Include wide

routing planes for OUT and GND to minimize inductance. If possible, mount the regulator immediately adjacent to the application load to minimize distributed inductance for optimal load transient performance. Point-of-load applications present the best case layout scenario for extracting full LT3072 performance.

Additional ceramic capacitors distributed beyond the immediate decoupling capacitors are acceptable and recommended at the point of load, because the distributed PCB inductance isolates them from the primary compensation capacitors.

Many of the applications in which the LT3072 excels, such as FPGA, ASIC processor or DSP supplies, typically require a high frequency decoupling capacitor network for the device being powered. This network generally consists of many low value ceramic capacitors in parallel. Multiple low value capacitors in parallel present a favorable frequency characteristic that reduces the parasitic inductance of the capacitors.

Although the LT3072 is stable with a single 10 μ F ceramic capacitor, typical 0603 or 0805 case-size capacitors have an ESL of ~800pH and PCB mounting can contribute up to ~200pH. For better transient response and improved high frequency PSRR, it may become necessary to reduce the parasitic inductance by using a parallel capacitor combination. A suitable methodology must control this paralleling as capacitors with the same self-resonant frequency, f_R , will form a tank circuit that can induce ringing of their own accord. Small amounts of ESR (5m Ω to 10m Ω)

APPLICATIONS INFORMATION

have some benefit in dampening the resonant loop, but higher ESRs degrade the capacitor response to transient load steps with rise/fall times less than 1 μ s. The most area efficient parallel capacitor combination is a graduated 7/2/1 scale of f_R of the same case size. Under these conditions, the individual ESLs are relatively uniform, and the resonance peaks are destructively spread beyond the regulator bandwidth. The recommended parallel combination that approximates 10 μ F is 6.8 μ F + 2.2 μ F + 1 μ F. Capacitors with case sizes larger than 0805 have higher ESL and lower ESR (<5m Ω). Users should consider new generation, low inductance capacitors to push out f_R and maximize stability. Refer to the surface mount ceramic capacitor manufacturer's data sheets for capacitor specifications. Figure 3 illustrates an optimum PCB layout for the

parallel output capacitor combination, but also illustrates the GND connection between the IN capacitor and the OUT capacitors to minimize the AC GND loop for fast load transients. This tight bypassing connection minimizes EMI and optimizes bypassing.

Give additional consideration to the use of ceramic capacitors. Ceramic capacitors are manufactured with a variety of dielectrics, each with different behavior across temperature and applied voltage. The most common dielectrics used are specified with EIA temperature characteristic codes of Z5U, Y5V, X5R and X7R. The Z5U and Y5V dielectrics are good for providing high capacitances in a small package, but they tend to have strong voltage and temperature coefficients as shown in Figures 4 and 5. When used with a 5V regulator, a 16V 10 μ F Y5V capacitor can

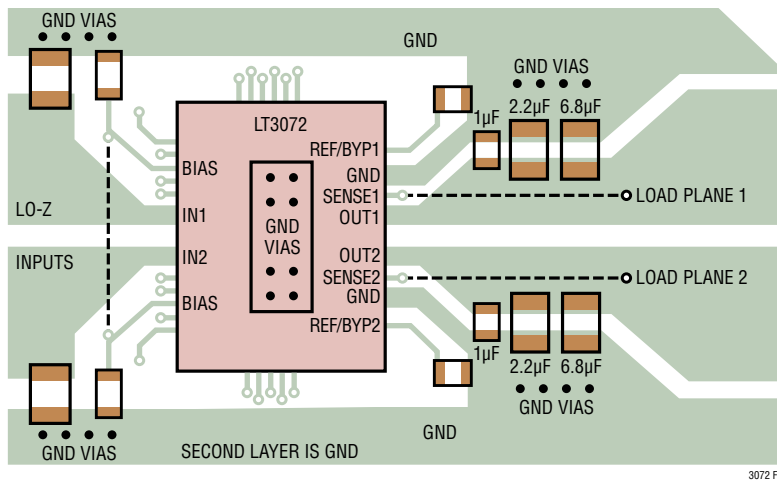

Figure 3. Example PCB Layout

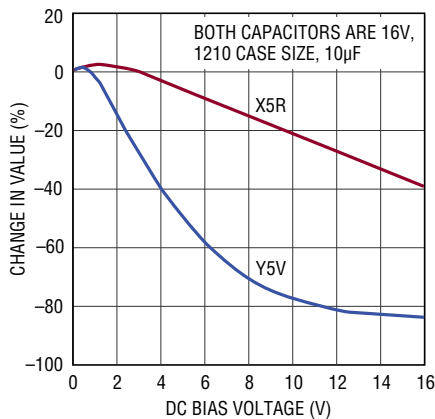

Figure 4. Ceramic Capacitor DC Bias Characteristics

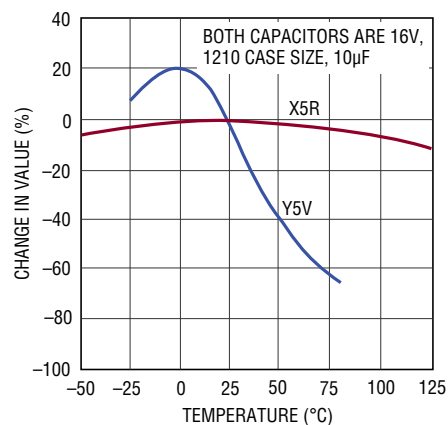

Figure 5. Ceramic Capacitor Temperature Characteristics

APPLICATIONS INFORMATION

exhibit an effective value as low as $1\mu\text{F}$ to $2\mu\text{F}$ for the DC bias voltage applied and over the operating temperature range. The X5R and X7R dielectrics result in more stable characteristics and are more suitable for use as the output capacitor.

The X7R type has better stability across temperature, while the X5R is less expensive and is available in higher values. Care still must be exercised when using X5R and X7R capacitors; the X5R and X7R codes only specify operating temperature range and maximum capacitance change over temperature. Capacitance change due to DC bias with X5R and X7R capacitors is better than Y5V and Z5U capacitors, but can still be significant enough to drop capacitor values below appropriate levels. Capacitor DC bias characteristics tend to improve as component case size increases, but expected capacitance at operating voltage should be verified. Voltage and temperature coefficients are not the only sources of problems. Some ceramic capacitors have a piezoelectric response. A piezoelectric device generates voltage across its terminals due to mechanical stress, similar to the way a piezoelectric microphone works. For a ceramic capacitor the stress can be induced by vibrations in the system or thermal transients.

Stability and Input Capacitance

The LT3072 is stable with a minimum capacitance of $22\mu\text{F}$ connected to the IN pins. Use low ESR capacitors to minimize instantaneous voltage drops under large-load transient conditions. Large V_{IN} droops during large-load transients may cause the regulator to enter dropout with corresponding degradation in load transient response. Increased values of input and output capacitance may be necessary depending on an application's requirements. Sufficient input capacitance is critical as the circuit is intentionally operated close to dropout to minimize power. Ideally, the output impedance of the supply that powers IN should be less than $20\text{m}\Omega$ to support a 2.5A load with large transients.

In cases where wire is used to connect a power supply to the input of the LT3072 (and also from the ground of the LT3072 back to the power supply ground), large input capacitors are required to avoid an unstable application.

This is due to the inductance of the wire forming an LC tank circuit with the input capacitor and not a result of the LT3072 being unstable. The self inductance, or isolated inductance, of a wire is directly proportional to its length. However, the diameter of a wire does not have a major influence on its self inductance. For example, one inch of 18-AWG, 0.04 inch diameter wire has 28nH of self inductance. The self inductance of a 2-AWG isolated wire with a diameter of 0.26 inch is about half the inductance of the 18-AWG wire. The overall self inductance of a wire can be reduced in two ways. One is to divide the current flowing toward the LT3072 between two parallel conductors. In this case, the farther the wires are placed apart from each other, the more the inductance is reduced, up to a 50% reduction when placed a few inches apart. Splitting the wires basically connects two equal inductors in parallel. However, when placed in close proximity to each other, mutual inductance is added to the overall self inductance of the wires. The most effective way to reduce overall inductance is to place the forward and return-current conductors (the wire for the input and the wire for the return ground) in very close proximity. In this case, two 18-AWG wires separated by 0.05 inch reduce the overall self inductance to about one-fourth of a single isolated wire. If the LT3072 is powered by a battery mounted in close proximity with ground and power planes on the same circuit board, a $22\mu\text{F}$ input capacitor is sufficient for stability. If, however, the LT3072 is powered by a distant supply, use a low ESR, large value input capacitor on the order of $220\mu\text{F}$. Also as power supply output impedance varies, the minimum input capacitance needed for application stability also varies.

Bias Pin Capacitance Requirements

The BIAS pin supplies current to most of the internal control circuitry and the output stage driving the pass transistor. The LT3072 requires a minimum $2.2\mu\text{F}$ bypass capacitor on each BIAS pin for stability and proper operation. To ensure proper operation, the BIAS voltage must satisfy the following conditions: $2.375\text{V} \leq V_{\text{BIAS}} \leq 5.25\text{V}$ and $V_{\text{BIAS}} \geq (V_{\text{OUT}} + 1.2\text{V})$. For $V_{\text{OUT}} \leq 1.15\text{V}$, the minimum BIAS voltage is limited to 2.375V.

APPLICATIONS INFORMATION

Load Regulation

The LT3072 corrects for parasitic package and PCB I-R drops when the sense pin is Kelvin connected to OUT. ADI recommends that the SENSE pin terminate in close proximity to the LT3072 OUT pins. This minimizes parasitic inductance and optimizes regulation. The LT3072 handles moderate levels of output line impedance, but excessive impedance between V_{OUT} and C_{OUT} causes excessive phase shift in the feedback loop and adversely affects stability.

Figure 1 in the Pin Functions section illustrates the Kelvin-sense connection method that eliminates voltage drops due to PCB trace resistance. However, note that the voltage drop across the external PCB traces adds to the drop-out voltage of the regulator. The SENSE pin input bias current depends on the selected output voltage. SENSE pin input current varies from 0 μ A at the unity gain settings of 0.6V and 1.2V and 12.5 μ A typically at $V_{OUT} = 0.65V$ to 325 μ A typically at $V_{OUT} = 2.5V$.

Short-Circuit Protection

The LT3072 has an internal current limit that typically clamps output current to 3.3A. In addition, the LT3072 has a $\pm 7\%$ accurate programmable precision current limit, except under conditions of maximum I_{LOAD} with maximum $V_{IN}-V_{OUT}$ when the device limits peak power dissipation to approximately 12W per channel. If ambient temperature is high enough, die junction temperature will exceed the 125°C maximum operating temperature. If this occurs, the LT3072 relies on an internal thermal safety feature. At 168°C typically, the LT3072 thermal shutdown engages and the output is shut down until the IC temperature falls below its thermal hysteresis limit.

Reverse Voltage Detector

The LT3072 detects if V_{IN} decreases below V_{OUT} . This reverse-voltage detector has a typical threshold of about $(V_{IN} - V_{OUT}) = -12mV$. If the threshold is exceeded, this detector circuit turns off the drive to the internal NMOS

pass transistor, thereby turning off the output. The output pulls low with the load current discharging the output capacitance. The intent is to limit back-feed current from OUT to IN to a maximum of 500mA typically prior to exceeding the threshold when the input voltage collapses due to a fault or overload condition.

Thermal Considerations

The LT3072 maximum rated junction temperature of 125°C limits its power handling capability and is dominated by the output current multiplied by the input/output voltage differential: $I_{OUT} \cdot (V_{IN} - V_{OUT})$. The internal power and thermal limiting circuitry protect the LT3072 under overload conditions. For continuous normal load conditions, do not exceed the maximum junction temperature of 125°C. Give careful consideration to all sources of thermal resistance from junction to ambient. This includes junction to case, case-to-heat sink interface, heat sink resistance or circuit board to ambient as the application dictates. Also, consider additional heat sources mounted in proximity to the LT3072. The LT3072 is a surface mount device and as such, heat sinking is accomplished by using the heat spreading capabilities of the PC board and its copper traces. Surface mount heat sinks and plated through-holes can also be used to spread the heat generated by power devices. Junction-to-case thermal resistance is specified from the IC junction to the bottom of the case directly below the die. This is the lowest resistance path for heat flow. Proper mounting is required to ensure the best possible thermal flow from this area of the package to the heat sinking material. Note that the exposed pad is electrically connected to GND.

Table 2 lists thermal resistance as a function of copper area in a fixed board size. All measurements were taken in still air on a 4-layer FR-4 board with 1oz solid internal planes and 2oz top/bottom external trace planes with a total board thickness of 1.6mm. PCB layers, copper weight, board layout and thermal vias affect the resultant thermal resistance. For further information on thermal resistance and high thermal conductivity test boards,

APPLICATIONS INFORMATION

refer to JEDEC standard JESD51, notably JESD51-12 and JESD51-7. Achieving low thermal resistance necessitates attention to detail and careful PCB layout.

Table 2. UFF Plastic Package, 36-Lead QFN

COPPER AREA		BOARD AREA	THERMAL RESISTANCE (JUNCTION-TO-AMBIENT)
TOPSIDE*	BACKSIDE		
2500mm ²	2500mm ²	2500mm ²	32°C/W
1000mm ²	2500mm ²	2500mm ²	33.5°C/W
225mm ²	2500mm ²	2500mm ²	37°C/W
100mm ²	2500mm ²	2500mm ²	42°C/W

*Device is mounted on topside

Paralleling Devices for Higher Output Current

Multiple LT3072s may be paralleled to obtain higher output current. This paralleling concept borrows from the scheme employed by the LT3080 product family.

To accomplish this paralleling, tie the IN pins and the OUT pins of the multiple devices together. Also, tie the REF/BYP pins of the multiple outputs together. This effectively gives an averaged value of multiple 1.2V reference voltage sources. The OUT of each LT3072 is connected to the common load using a small piece of PC trace as a ballast resistor ($\approx 3\text{m}\Omega$) or an actual sense resistor, beyond the feedback SENSE tap of each regulator. The ballast resistor ensures output current sharing. Keep this ballast trace area free of solder to maintain a controlled resistance.

Table 3 shows a simple guideline for PCB trace resistance as a function of weight and trace width.

Table 3. PC Board Trace Resistance*

WEIGHT (oz)	100 MIL WIDTH	200 MIL WIDTH
1	5.43	2.71
2	2.71	1.36

*Trace resistance is measured in milliohms/inch

Quieting the Noise

The LT3072 offers numerous noise performance advantages. Each LDO has several sources of noise. An LDO's most critical noise source is the reference, followed by the LDO error amplifier. Traditional low noise regulators buffer the voltage reference out to an external pin (usually through a large value resistor) to allow for bypassing and noise reduction of reference noise. The LT3072 deviates from the traditional voltage reference by generating a low voltage V_{REF} from a chopper stabilized reference current into an internal resistor $\approx 18\text{k}$. This moderate impedance node (REF/BYP) facilitates external filtering directly. A 100nF filter cap minimizes reference noise to $5\mu\text{V}_{RMS}$ at the 1.2V REF/BYP pin. See the Typical Performance curves for RMS Output Noise versus Output Current performance as a function of $C_{REF/BYP}$.

This approach also accommodates reference sharing between LT3072 regulators that are paralleled in current sharing applications. The REF/BYP filter capacitor delays the initial power-up time by a factor of the RC time constant. Pulling the EN pin low pulls down the channel reference with the internal 18k resistor, so the REF/BYP filter capacitor soft-starts V_{OUT} coming out of nap mode.

TYPICAL APPLICATIONS

1V, 5A Point-of-Load Current Sharing Regulators

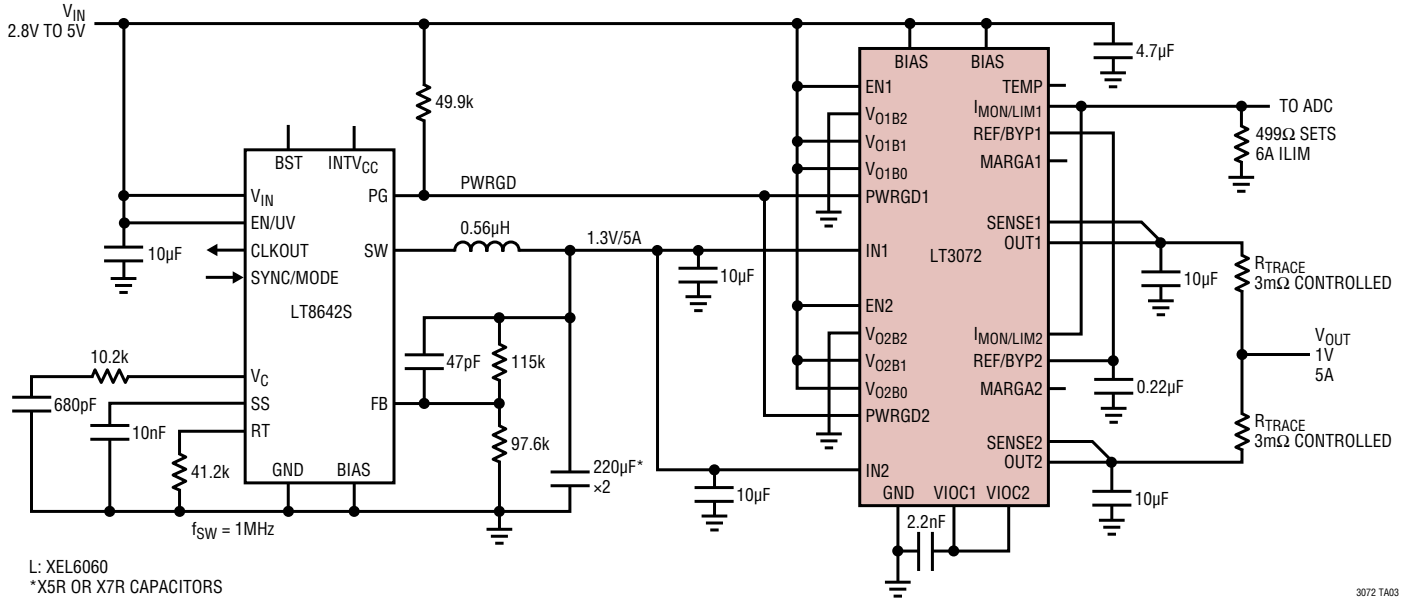

PACKAGE DESCRIPTION

UFF Package
36-Lead Plastic QFN (4mm × 7mm)
 (Reference LTC DWG # 05-08-1863 Rev 0)

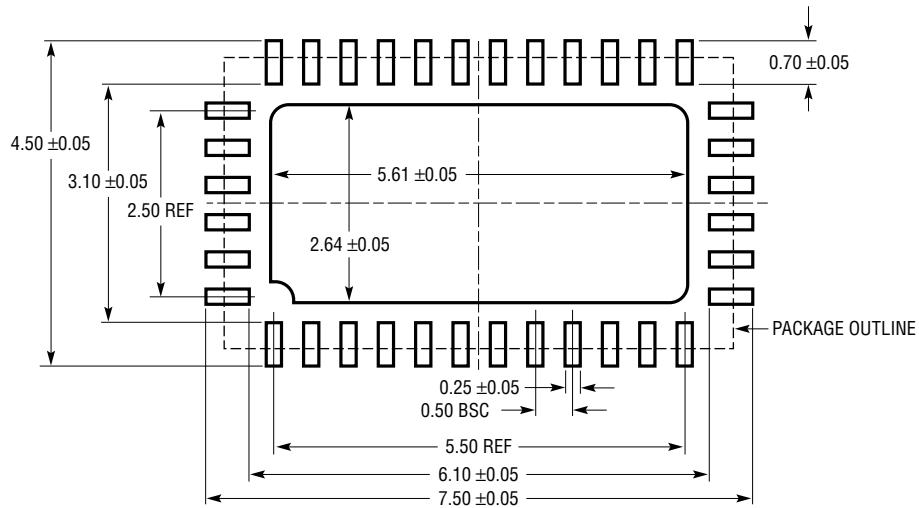

RECOMMENDED SOLDER PAD PITCH AND DIMENSIONS
 APPLY SOLDER MASK TO AREAS THAT ARE NOT SOLDERED

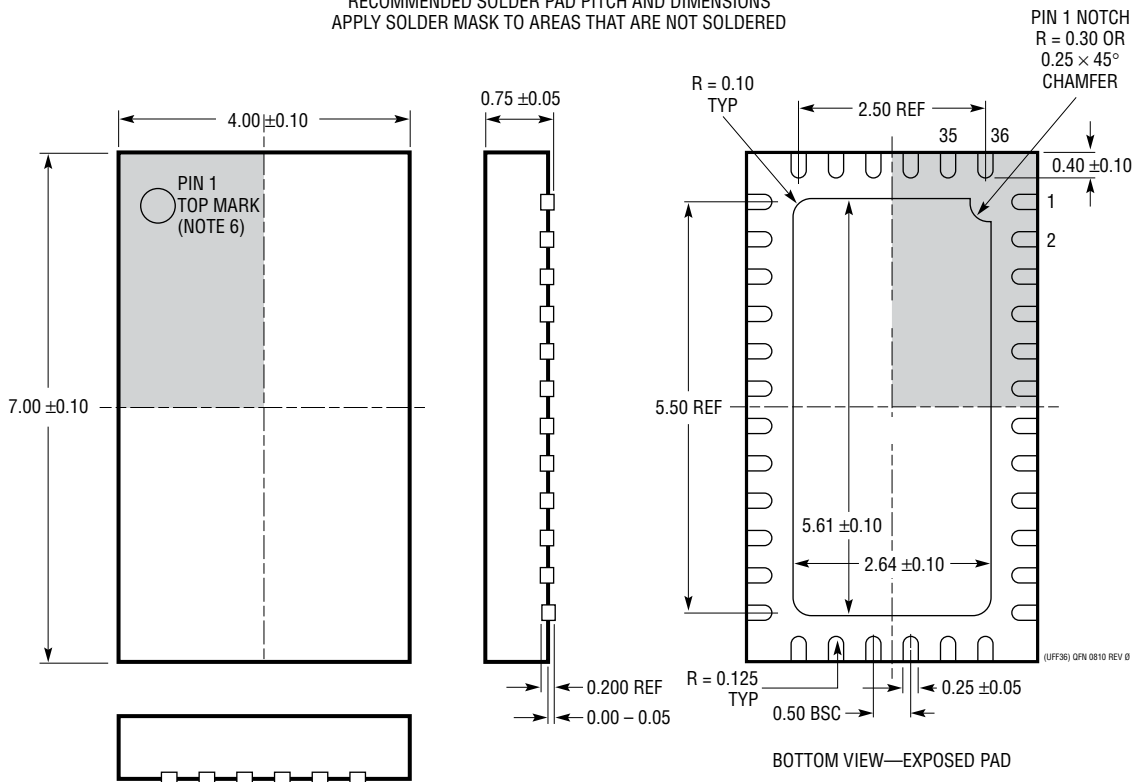

- NOTE:
1. DRAWING IS NOT A JEDEC PACKAGE OUTLINE
 2. DRAWING NOT TO SCALE
 3. ALL DIMENSIONS ARE IN MILLIMETERS
 4. DIMENSIONS OF EXPOSED PAD ON BOTTOM OF PACKAGE DO NOT INCLUDE MOLD FLASH. MOLD FLASH, IF PRESENT, SHALL NOT EXCEED 0.20mm ON ANY SIDE
 5. EXPOSED PAD SHALL BE SOLDER PLATED
 6. SHADED AREA IS ONLY A REFERENCE FOR PIN 1 LOCATION ON THE TOP AND BOTTOM OF PACKAGE

TYPICAL APPLICATION

BIAS/2.5V/1.8V Supply Sequencing

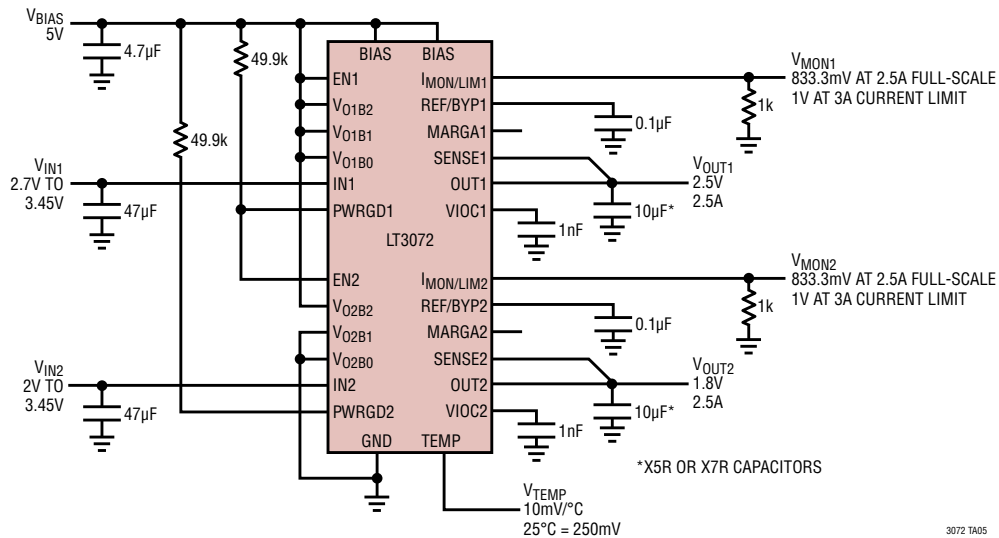

3072 TA05

RELATED PARTS

PART NUMBER	DESCRIPTION	COMMENTS
LT1764/LT1764A	3A, Fast Transient Response, Low Noise LDO	340mV Dropout Voltage, Low Noise: 40µV _{RMS} , V _{IN} : 2.7V to 20V, TO-220 and DD Packages, LT1764A Version Stable Also with Ceramic Capacitors
LT1963/LT1963A	1.5A, Low Noise, Fast Transient Response LDO	340mV Dropout Voltage, Low Noise: 40µV _{RMS} , V _{IN} : 2.5V to 20V, LT1963A Version Stable with Ceramic Capacitors, TO-220, DD-PAK, SOT-223 and SO-8 Packages
LT1965	1.1A, Low Noise, Low Dropout Linear Regulator	310mV Dropout Voltage, Low Noise: 40µV _{RMS} , V _{IN} : 1.8V to 20V, V _{OUT} : 1.2V to 19.5V, Stable with Ceramic Capacitors, TO-220, DD-PAK, MSOP and 3mm × 3mm DFN Packages
LT3022	1A, Low Voltage VLDO Linear Regulator	145mV Dropout Voltage, V _{IN} : 0.9V to 10V, V _{OUT} : 0.2V to 9.5V, Stable with Low ESR, Ceramic Output Capacitors, 16-Pin DFN (5mm × 3mm) and 16-Lead MSOP Packages
LT3033	3A, Low Voltage VLDO Linear Regulator	95mV Dropout Voltage, V _{IN} : 0.95V to 10V, V _{OUT} : 0.2V to 9.5V, Stable with Low ESR Ceramic Output Capacitors, 20-Pin QFN (3mm × 4mm)
LT3045	20V, 500mA Ultralow Noise and Ultrahigh PSRR LDO	0.8µV _{RMS} Noise and 76dB PSRR at 1MHz, V _{IN} : 1.8V to 20V, 260mV Dropout Voltage
LT3070/LT3070-1	5A, Low Noise, Programmable V _{OUT} , 85mV Dropout Linear Regulator with Digital Margining	85mV Dropout Voltage, Digitally Programmable V _{OUT} : 0.8V to 1.8V, Digital Output Margining: ±1%, ±3% or ±5%, Low Output Noise: 25µV _{RMS} ; Directly Parallelable, Stable with Low ESR Ceramic Output Capacitors (15µF Minimum), 28 Lead 4mm × 5mm QFN Package
LT3071	5A, Low Noise, Programmable V _{OUT} , 85mV Dropout Linear Regulator with Analog Margining	85mV Dropout Voltage, Digitally Programmable V _{OUT} : 0.8V to 1.8V, Analog Margining: ±10%, Low Output Noise: 25µV _{RMS} ; Directly Parallelable, Output Current Monitor, Stable with Low ESR Ceramic Output Capacitors (15µF Minimum), 28 Lead 4mm × 5mm QFN Package
LT3080/LT3080-1	1.1A, Parallelable, Low Noise, Low Dropout Linear Regulator	300mV Dropout Voltage (2-Supply Operation), Low Noise: 40µV _{RMS} , V _{IN} : 1.2V to 36V, V _{OUT} : 0V to 35.7V, Current-Based Reference with 1-Resistor V _{OUT} Set; Directly Parallelable (No Op Amp Required), Stable with Ceramic Capacitors; TO-220, DD-PAK, SOT-223, MSOP and 3mm × 3mm DFN-8 Packages; LT3080-1 Has Integrated Internal Ballast Resistor
LT3083	3A, Parallelable, Low Noise, Low Dropout Linear Regulator	310mV Dropout Voltage (2-Supply Operation), Low Noise: 40µV _{RMS} , V _{IN} : 1.2V to 23V, V _{OUT} : 0V to 22.6V, Current-Based Reference with 1 Resistor V _{OUT} Set, Directly Parallelable (No Op Amp Required), Stable with Ceramic Capacitors; TO-220, DD-PAK, TSSOP, 4mm × 4mm DFN-12 Packages

Rev. 0

Looking for pricing, stock, or lifecycle information?

Click below to explore more details on WIN SOURCE:

- ⊖ [View LT3072IUFF#TRPBF on WIN SOURCE](#)
- ⊖ [Analog Devices Inc. Information](#)

Optimize Your Supply Chain with WIN SOURCE Solutions

- ✓ Global Sourcing Solution
- ✓ Obsolete Management
- ✓ Cost Control Management
- ✓ Shortage Management
- ✓ Alternative Solution
- ✓ Excess Inventory Management