



**THE DATASHEET OF
DS90C032TM/NOPB**



DS90C032 LVDS Quad CMOS Differential Line Receiver

Check for Samples: [DS90C032](#)

FEATURES

- >155.5 Mbps (77.7 MHz) switching rates
- Accepts small swing (350 mV) differential signal levels
- Ultra low power dissipation
- 600 ps maximum differential skew (5V, 25°C)
- 6.0 ns maximum propagation delay
- Industrial operating temperature range
- Military operating temperature range option
- Available in surface mount packaging (SOIC) and (LCCC)
- Pin compatible with DS26C32A, MB570 (PECL), and 41LF (PECL)
- Supports OPEN input fail-safe
- Supports short and terminated input fail-safe with the addition of external failsafe biasing
- Compatible with IEEE 1596.3 SCI LVDS standard
- Conforms to ANSI/TIA/EIA-644 LVDS standard
- Available to Standard Microcircuit Drawing (SMD) 5962-95834

DESCRIPTION

The DS90C032 is a quad CMOS differential line receiver designed for applications requiring ultra low power dissipation and high data rates. The device supports data rates in excess of 155.5 Mbps (77.7 MHz) and uses Low Voltage Differential Signaling (LVDS) technology.

The DS90C032 accepts low voltage (350 mV) differential input signals and translates them to CMOS (TTL compatible) output levels. The receiver supports a TRI-STATE function that may be used to multiplex outputs. The receiver also supports OPEN, shorted, and terminated (100Ω) input Failsafe with the addition of external failsafe biasing. Receiver output will be HIGH for both Failsafe conditions.

The DS90C032 and companion line driver (DS90C031) provide a new alternative to high power pseudo-ECL devices for high speed point-to-point interface applications.

Connection Diagram

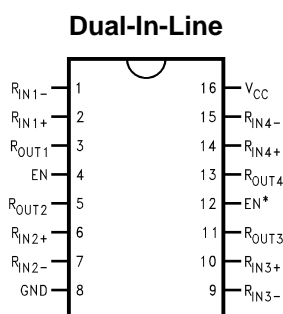

Figure 1. See Package Number D (R-PDSO-G16)



Please be aware that an important notice concerning availability, standard warranty, and use in critical applications of Texas Instruments semiconductor products and disclaimers thereto appears at the end of this data sheet.

All trademarks are the property of their respective owners.

Functional Diagram and Truth Table

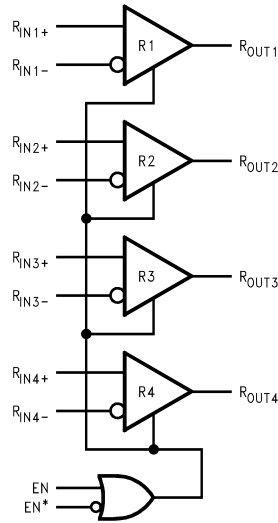

Receiver

| ENABLES | | INPUTS | OUTPUT |
|---|-----|---|------------------|
| EN | EN* | R _{IN+} - R _{IN-} | R _{OUT} |
| L | H | X | Z |
| All other combinations of ENABLE inputs | | $V_{ID} \geq 0.1V$ | H |
| | | $V_{ID} \leq -0.1V$ | L |
| | | Full Fail-safe OPEN/SHORT or Terminated | H |



These devices have limited built-in ESD protection. The leads should be shorted together or the device placed in conductive foam during storage or handling to prevent electrostatic damage to the MOS gates.

Absolute Maximum Ratings ⁽¹⁾⁽²⁾

| | |
|--|------------------------------|
| Supply Voltage (V_{CC}) | -0.3V to +6V |
| Input Voltage (R_{IN+} , R_{IN-}) | -0.3V to ($V_{CC} + 0.3V$) |
| Enable Input Voltage (EN , EN^*) | -0.3V to ($V_{CC} + 0.3V$) |
| Output Voltage (R_{OUT}) | -0.3V to ($V_{CC} + 0.3V$) |
| Maximum Package Power Dissipation at +25°C | |
| D Package | 1025 mW |
| NAJ Package | 1830 mW |
| Derate D Package | 8.2 mW/°C above +25°C |
| Derate NAJ Package | 12.2 mW/°C above +25°C |
| Storage Temperature Range | -65°C to +150°C |
| Lead Temperature Range Soldering (4 seconds) | +260°C |
| Maximum Junction Temperature (DS90C032T) | +150°C |
| Maximum Junction Temperature (DS90C032E) | +175°C |
| ESD Ratings | |
| (HBM, 1.5 k Ω , 100 pF) | $\geq 3500V$ |
| (EIAJ, 0 Ω , 200 pF) | $\geq 250V$ |

- (1) "Absolute Maximum Ratings" are those values beyond which the safety of the device cannot be ensured. They are not meant to imply that the devices should be operated at these limits. The table of "Electrical Characteristics" specifies conditions of device operation.
- (2) Current into device pins is defined as positive. Current out of device pins is defined as negative. All voltages are referenced to ground unless otherwise specified.

Recommended Operating Conditions ⁽¹⁾⁽²⁾

| | | Min | Typ | Max | Units |
|--|-----------|------|------|------|-------|
| Supply Voltage (V_{CC}) | | +4.5 | +5.0 | +5.5 | V |
| Receiver Input Voltage | | GND | | 2.4 | V |
| Operating Free Air Temperature (T_A) | DS90C032T | -40 | +25 | +85 | °C |
| | DS90C032E | -55 | +25 | +125 | °C |

- (1) "Absolute Maximum Ratings" are those values beyond which the safety of the device cannot be ensured. They are not meant to imply that the devices should be operated at these limits. The table of "Electrical Characteristics" specifies conditions of device operation.
- (2) Current into device pins is defined as positive. Current out of device pins is defined as negative. All voltages are referenced to ground unless otherwise specified.

Electrical Characteristics

Over Supply Voltage and Operating Temperature ranges, unless otherwise specified.

| Symbol | Parameter | Conditions | Pin | Min | Typ | Max | Units |
|-----------|--|---|--------------------------|-----------|---------|------|---------|
| V_{TH} | Differential Input High Threshold | $V_{CM} = +1.2V$ | R_{IN+} , R_{IN-} | | | +100 | mV |
| V_{TL} | Differential Input Low Threshold | | | -100 | | | mV |
| I_{IN} | Input Current | $V_{IN} = +2.4V$ | $V_{CC} = 5.5V$ | -10 | ± 1 | +10 | μA |
| | | $V_{IN} = 0V$ | | -10 | ± 1 | +10 | μA |
| V_{OH} | Output High Voltage | $I_{OH} = -0.4 mA$, $V_{ID} = +200 mV$ | R_{OUT} | 3.8 | 4.9 | | V |
| | | $I_{OH} = -0.4 mA$, Input terminated | | DS90C032T | 3.8 | 4.9 | |
| V_{OL} | Output Low Voltage | $I_{OL} = 2 mA$, $V_{ID} = -200 mV$ | | | 0.07 | 0.3 | V |
| I_{OS} | Output Short Circuit Current | Enabled, $V_{OUT} = 0V$ ⁽¹⁾ | | -15 | -60 | -100 | mA |
| I_{OZ} | Output TRI-STATE Current | Disabled, $V_{OUT} = 0V$ or V_{CC} | | -10 | ± 1 | +10 | μA |
| V_{IH} | Input High Voltage | | EN, EN* | 2.0 | | | V |
| V_{IL} | Input Low Voltage | | | | | 0.8 | V |
| I_I | Input Current | | | -10 | ± 1 | +10 | μA |
| V_{CL} | Input Clamp Voltage | $I_{CL} = -18 mA$ | | -1.5 | -0.8 | | V |
| I_{CC} | No Load Supply Current, Receivers Enabled | EN, EN* = V_{CC} or GND, Inputs Open | DS90C032T | | 3.5 | 10 | mA |
| | | | DS90C032E | | 3.5 | 11 | mA |
| | | EN, EN* = 2.4 or 0.5, Inputs Open | | 3.7 | 11 | mA | |
| I_{CCZ} | No Load Supply Current, Receivers Disabled | EN = GND, EN* = V_{CC} , Inputs Open | DS90C032T | | 3.5 | 10 | mA |
| | | | DS90C032E | | 3.5 | 11 | mA |

(1) Output short circuit current (I_{OS}) is specified as magnitude only, minus sign indicates direction only. Only one output should be shorted at a time, do not exceed maximum junction temperature specification.

Switching Characteristics

$V_{CC} = +5.0V$, $T_A = +25^\circ C$, DS90C032T⁽¹⁾⁽²⁾⁽³⁾⁽⁴⁾

| Symbol | Parameter | Conditions | Min | Typ | Max | Units | |
|------------|--|--|---|------|-----|-------|----|
| t_{PHLD} | Differential Propagation Delay High to Low | $C_L = 5 pF$, $V_{ID} = 200 mV$, See Figure 2 and Figure 3 | 1.5 | 3.40 | 5.0 | ns | |
| t_{PLHD} | Differential Propagation Delay Low to High | | 1.5 | 3.48 | 5.0 | ns | |
| t_{SKD} | Differential Skew $ t_{PHLD} - t_{PLHD} $ | | 0 | 80 | 600 | ps | |
| t_{SK1} | Channel-to-Channel Skew ⁽³⁾ | | 0 | 0.6 | 1.0 | ns | |
| t_{TLH} | Rise Time | | | | 0.5 | 2.0 | ns |
| t_{THL} | Fall Time | | | | 0.5 | 2.0 | ns |
| t_{PHZ} | Disable Time High to Z | | $R_L = 2 k\Omega$, $C_L = 10 pF$, See Figure 4 and Figure 5 | | 10 | 15 | ns |
| t_{PLZ} | Disable Time Low to Z | | | 10 | 15 | ns | |
| t_{PZH} | Enable Time Z to High | | | 4 | 10 | ns | |
| t_{PZL} | Enable Time Z to Low | | | 4 | 10 | ns | |

(1) All typical values are given for: $V_{CC} = +5.0V$, $T_A = +25^\circ C$.

(2) Generator waveform for all tests unless otherwise specified: $f = 1 MHz$, $Z_O = 50\Omega$, t_r and t_f (0%–100%) $\leq 1 ns$ for R_{IN} and t_r and $t_f \leq 6 ns$ for EN or EN*.

(3) Channel-to-Channel Skew is defined as the difference between the propagation delay of one channel and that of the others on the same chip with an event on the inputs.

(4) C_L includes probe and jig capacitance.

Switching Characteristics

 $V_{CC} = +5.0V \pm 10\%$, $T_A = -40^\circ\text{C}$ to $+85^\circ\text{C}$, DS90C032T⁽¹⁾⁽²⁾⁽³⁾⁽⁴⁾⁽⁵⁾

| Symbol | Parameter | Conditions | Min | Typ | Max | Units |
|------------|--|---|-----|------|-----|-------|
| t_{PHLD} | Differential Propagation Delay High to Low | $C_L = 5\text{ pF}$, $V_{ID} = 200\text{ mV}$, See Figure 2 and Figure 3 | 1.0 | 3.40 | 6.0 | ns |
| t_{PLHD} | Differential Propagation Delay Low to High | | 1.0 | 3.48 | 6.0 | ns |
| t_{SKD} | Differential Skew $ t_{PHLD} - t_{PLHD} $ | | 0 | 0.08 | 1.2 | ns |
| t_{SK1} | Channel-to-Channel Skew ⁽³⁾ | | 0 | 0.6 | 1.5 | ns |
| t_{SK2} | Chip to Chip Skew ⁽⁴⁾ | | | | 5.0 | ns |
| t_{TLH} | Rise Time | | | | 0.5 | ns |
| t_{THL} | Fall Time | | | | 0.5 | ns |
| t_{PHZ} | Disable Time High to Z | $R_L = 2\text{ k}\Omega$, $C_L = 10\text{ pF}$, See Figure 4 and Figure 5 | | 10 | 20 | ns |
| t_{PLZ} | Disable Time Low to Z | | | 10 | 20 | ns |
| t_{PZH} | Enable Time Z to High | | | 4 | 15 | ns |
| t_{PZL} | Enable Time Z to Low | | | 4 | 15 | ns |

- (1) All typical values are given for: $V_{CC} = +5.0V$, $T_A = +25^\circ\text{C}$.
- (2) Generator waveform for all tests unless otherwise specified: $f = 1\text{ MHz}$, $Z_O = 50\Omega$, t_r and t_f (0%–100%) $\leq 1\text{ ns}$ for R_{IN} and t_r and $t_f \leq 6\text{ ns}$ for EN or EN*.
- (3) Channel-to-Channel Skew is defined as the difference between the propagation delay of one channel and that of the others on the same chip with an event on the inputs.
- (4) Chip to Chip Skew is defined as the difference between the minimum and maximum specified differential propagation delays.
- (5) C_L includes probe and jig capacitance.

Switching Characteristics

 $V_{CC} = +5.0V \pm 10\%$, $T_A = -55^\circ\text{C}$ to $+125^\circ\text{C}$, DS90C032E⁽¹⁾⁽²⁾⁽³⁾⁽⁴⁾⁽⁵⁾⁽⁶⁾

| Symbol | Parameter | Conditions | Min | Typ | Max | Units |
|------------|--|---|-----|------|-----|-------|
| t_{PHLD} | Differential Propagation Delay High to Low | $C_L = 20\text{ pF}$, $V_{ID} = 200\text{ mV}$, See Figure 2 and Figure 3 | 1.0 | 3.40 | 8.0 | ns |
| t_{PLHD} | Differential Propagation Delay Low to High | | 1.0 | 3.48 | 8.0 | ns |
| t_{SKD} | Differential Skew $ t_{PHLD} - t_{PLHD} $ | | 0 | 0.08 | 3.0 | ns |
| t_{SK1} | Channel-to-Channel Skew ⁽³⁾ | | 0 | 0.6 | 3.0 | ns |
| t_{SK2} | Chip to Chip Skew ⁽⁴⁾ | | | | 7.0 | ns |
| t_{PHZ} | Disable Time High to Z | $R_L = 2\text{ k}\Omega$, $C_L = 10\text{ pF}$, See Figure 4 and Figure 5 | | 10 | 20 | ns |
| t_{PLZ} | Disable Time Low to Z | | | 10 | 20 | ns |
| t_{PZH} | Enable Time Z to High | | | 4 | 20 | ns |
| t_{PZL} | Enable Time Z to Low | | | 4 | 20 | ns |

- (1) All typical values are given for: $V_{CC} = +5.0V$, $T_A = +25^\circ\text{C}$.
- (2) Generator waveform for all tests unless otherwise specified: $f = 1\text{ MHz}$, $Z_O = 50\Omega$, t_r and t_f (0%–100%) $\leq 1\text{ ns}$ for R_{IN} and t_r and $t_f \leq 6\text{ ns}$ for EN or EN*.
- (3) Channel-to-Channel Skew is defined as the difference between the propagation delay of one channel and that of the others on the same chip with an event on the inputs.
- (4) Chip to Chip Skew is defined as the difference between the minimum and maximum specified differential propagation delays.
- (5) C_L includes probe and jig capacitance.
- (6) For DS90C032E propagation delay measurements are from 0V on the input waveform to the 50% point on the output (ROUT).

Parameter Measurement Information

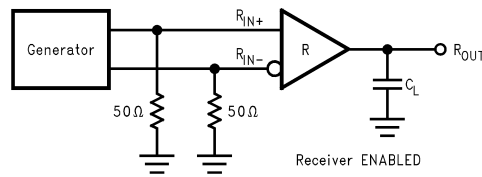

Figure 2. Receiver Propagation Delay and Transition Time Test Circuit

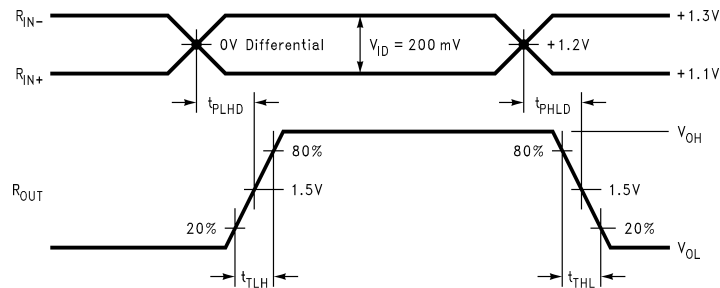
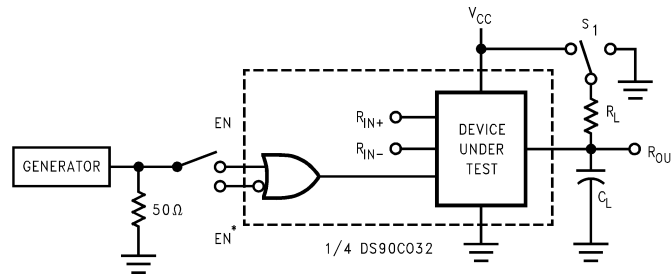

Figure 3. Receiver Propagation Delay and Transition Time Waveforms



C_L includes load and test jig capacitance.
 $S_1 = V_{CC}$ for t_{PZL} and t_{PLZ} measurements.
 $S_1 = GND$ for t_{PZH} and t_{PHZ} measurements.

Figure 4. Receiver TRI-STATE Delay Test Circuit

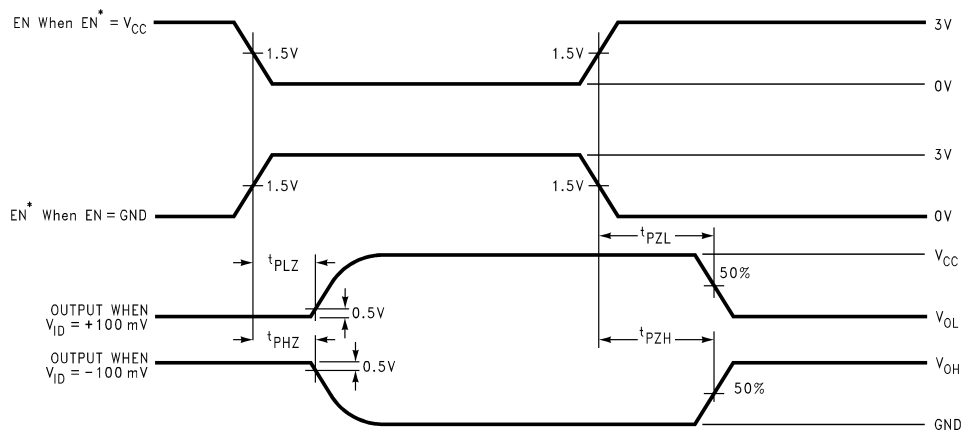

Figure 5. Receiver TRI-STATE Delay Waveforms

TYPICAL APPLICATION

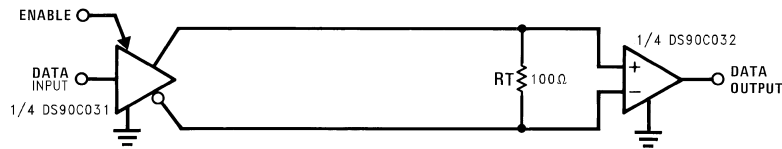

Figure 6. Point-to-Point Application

APPLICATIONS INFORMATION

LVDS drivers and receivers are intended to be primarily used in an uncomplicated point-to-point configuration as is shown in [Figure 6](#). This configuration provides a clean signaling environment for the quick edge rates of the drivers. The receiver is connected to the driver through a balanced media which may be a standard twisted pair cable, a parallel pair cable, or simply PCB traces. Typically the characteristic impedance of the media is in the range of 100Ω. A termination resistor of 100Ω should be selected to match the media, and is located as close to the receiver input pins as possible. The termination resistor converts the current sourced by the driver into a voltage that is detected by the receiver. Other configurations are possible such as a multi-receiver configuration, but the effects of mid-stream connectors, cable stubs, and other impedance discontinuities as well as ground shifting, noise margin limits, and total termination loading must be taken into account.

The DS90C032 differential line receiver is capable of detecting signals as low as 100 mV, over a ±1V common-mode range centered around +1.2V. This is related to the driver offset voltage which is typically +1.2V. The driven signal is centered around this voltage and may shift ±1V around this center point. The ±1V shifting may be the result of a ground potential difference between the driver's ground reference and the receiver's ground reference, the common-mode effects of coupled noise, or a combination of the two. Both receiver input pins should honor their specified operating input voltage range of 0V to +2.4V (measured from each pin to ground), exceeding these limits may turn on the ESD protection circuitry which will clamp the bus voltages.

Receiver Fail-Safe

The LVDS receiver is a high-gain high-speed device that amplifies a small differential signal (20mV) to CMOS logic levels. Due to the high gain and tight threshold of the receiver, care should be taken to prevent noise from appearing as a valid signal.

The receiver's internal fail-safe circuitry is designed to source or sink a small amount of current, providing fail-safe protection (a stable known state of HIGH output voltage) for floating, terminated, or shorted receiver inputs.

- Open Input Pins.** The DS90C032 is a quad receiver device, and if an application requires only 1, 2, or 3 receivers, the unused channel inputs should be left OPEN. Do not tie unused receiver inputs to ground or any other voltages. The input is biased by internal high-value pullup and pulldown resistors to set the output to a HIGH state. This internal circuitry ensures a HIGH stable output state for open inputs.
- Terminated Input.** The DS90C032 requires external failsafe biasing for terminated input failsafe. Terminated input failsafe is the case of a receiver that has a 100Ω termination across its inputs and the driver is in the following situations. Unplugged from the bus, or the driver output is in TRI-STATE or in power-off condition. The use of external biasing resistors provide a small bias to set the differential input voltage while the line is un-driven, and therefore the receiver output will be in HIGH state. If the driver is removed from the bus but the cable is still present and floating, the unplugged cable can become a floating antenna that can pick up noise. The LVDS receiver is designed to detect very small amplitude and width signals and recover them to standard logic levels. Thus, if the cable picks up more than 10mV of differential noise, the receiver may respond. To insure that any noise is seen as common-mode and not differential, a balanced interconnect and twisted pair cables is recommended, as they help to ensure that noise is coupled common to both lines and rejected by the receivers.
- Shorted Inputs.** If a fault condition occurs that shorts the receiver inputs together, thus resulting in a 0V differential input voltage, the receiver output will remain in a HIGH state. Shorted input fail-safe is not supported across the common-mode range of the device (1.2V ±1V). It is only supported with inputs shorted and no external common-mode voltage applied.
- Operation in environment with greater than 10mV differential noise.**

TI recommends external failsafe biasing on its LVDS receivers for a number of system level and signal

quality reasons. First, only an application that requires failsafe biasing needs to employ it. Second, the amount of failsafe biasing is now an application design parameter and can be custom tailored for the specific application. In applications in low noise environments, they may choose to use a very small bias if any. For applications with less balanced interconnects and/or in high noise environments they may choose to boost failsafe further. TI's LVDS Owner's Manual provides detailed calculations for selecting the proper failsafe biasing resistors. Third, the common-mode voltage is biased by the resistors during the un-driven state. This is selected to be close to the nominal driver offset voltage (V_{OS}). Thus when switching between driven and un-driven states, the common-mode modulation on the bus is held to a minimum.

For additional Failsafe Biasing information, please refer to Application Note AN-1194 ([SNLA051](#)) for more detail.

The footprint of the DS90C032 is the same as the industry standard 26LS32 Quad Differential (RS-422) Receiver.

Pin Descriptions

| Pin No. (SOIC) | Name | Description |
|----------------|-----------|--|
| 2, 6, 10, 14 | R_{IN+} | Non-inverting receiver input pin |
| 1, 7, 9, 15 | R_{IN-} | Inverting receiver input pin |
| 3, 5, 11, 13 | R_{OUT} | Receiver output pin |
| 4 | EN | Active high enable pin, OR-ed with EN* |
| 12 | EN* | Active low enable pin, OR-ed with EN |
| 16 | V_{CC} | Power supply pin, +5V \pm 10% |
| 8 | GND | Ground pin |

Typical Performance Characteristics

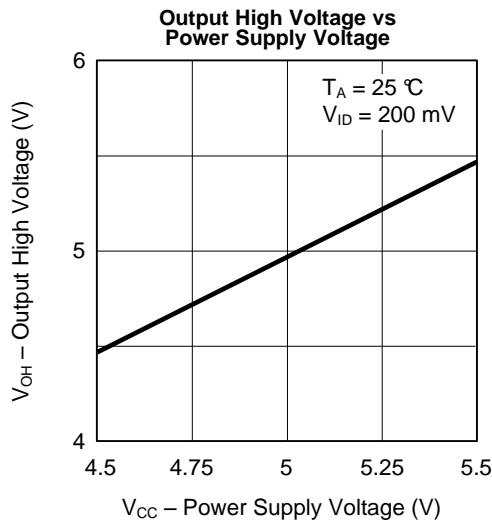

Figure 7.

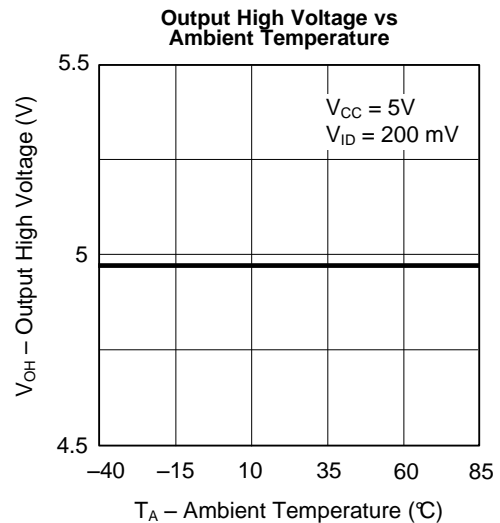

Figure 8.

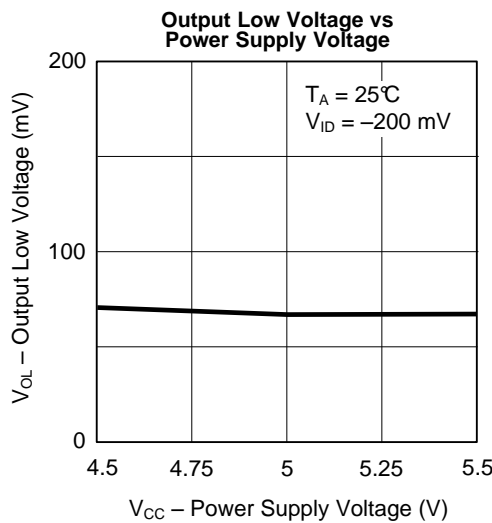

Figure 9.

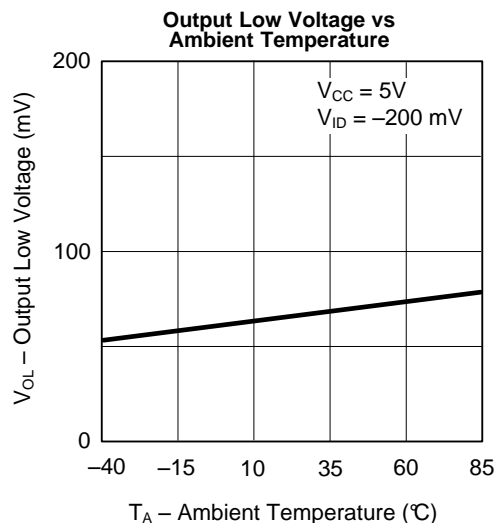

Figure 10.

Typical Performance Characteristics (continued)

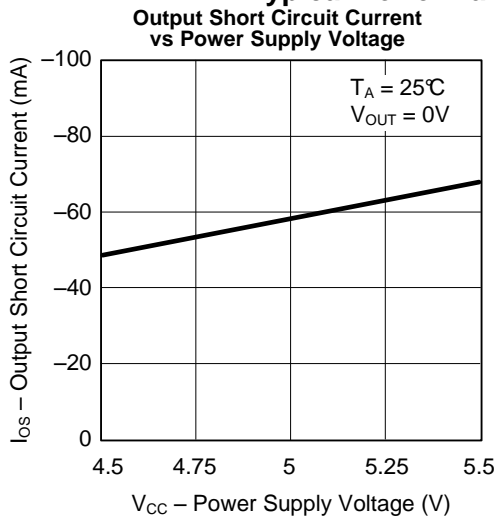

Figure 11.

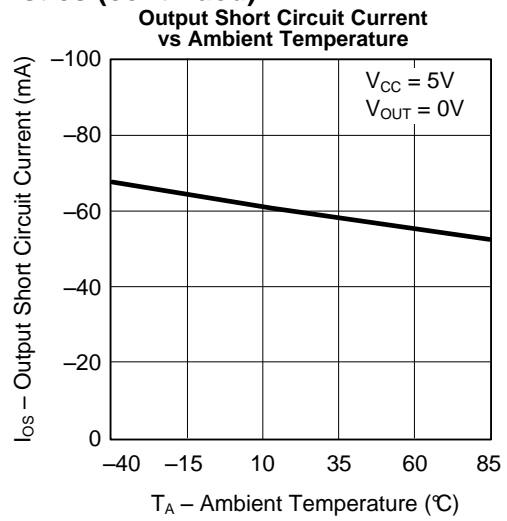

Figure 12.

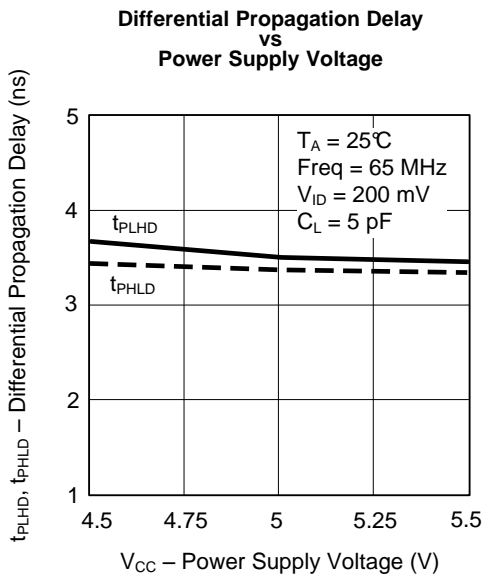

Figure 13.

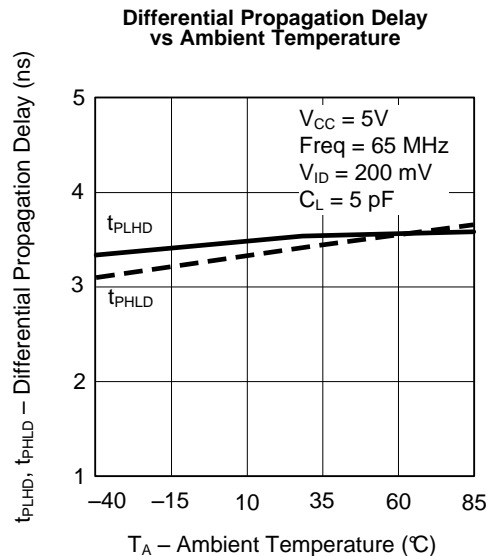

Figure 14.

Typical Performance Characteristics (continued)

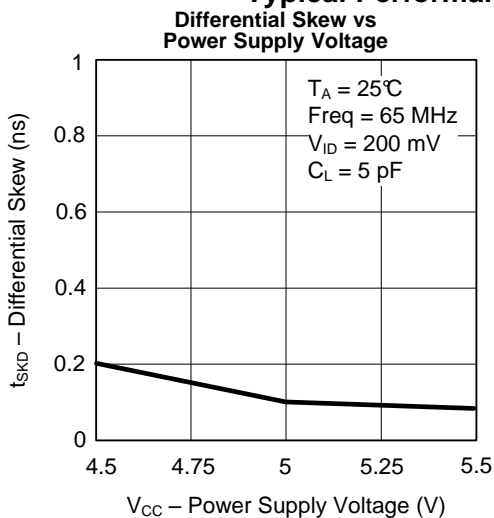

Figure 15.

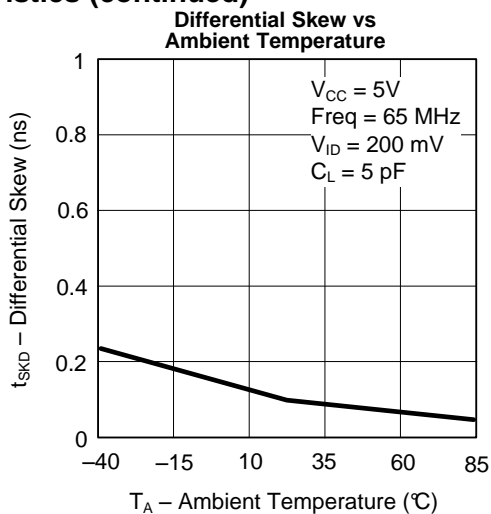

Figure 16.

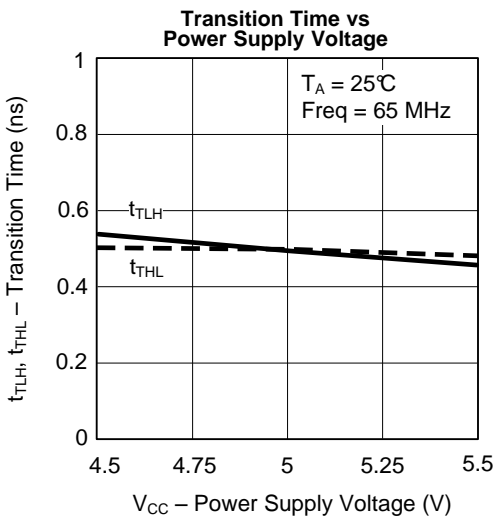

Figure 17.

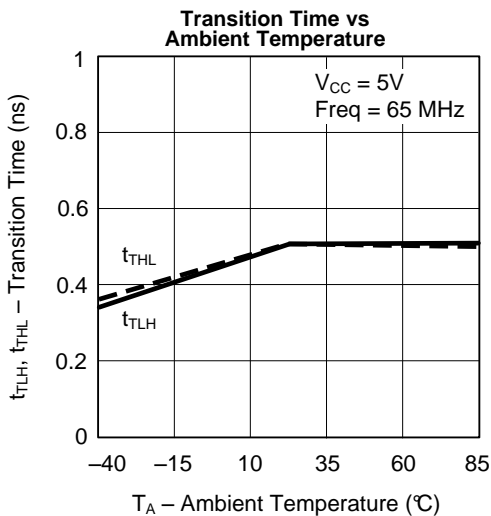



Figure 18.

REVISION HISTORY

| Changes from Revision C (April 2013) to Revision D | Page |
|--|------|
| • Changed layout of National Data Sheet to TI format | 11 |

PACKAGING INFORMATION

| Orderable Device | Status (1) | Package Type | Package Drawing | Pins | Package Qty | Eco Plan (2) | Lead/Ball Finish (6) | MSL Peak Temp (3) | Op Temp (°C) | Device Marking (4/5) | Samples |
|------------------|---------------|--------------|-----------------|------|-------------|-------------------------|-------------------------|----------------------|--------------|-------------------------|---|
| DS90C032TM | NRND | SOIC | D | 16 | 48 | TBD | Call TI | Call TI | -40 to 85 | DS90C032TM | |
| DS90C032TM/NOPB | ACTIVE | SOIC | D | 16 | 48 | Green (RoHS & no Sb/Br) | CU SN | Level-1-260C-UNLIM | -40 to 85 | DS90C032TM |  |
| DS90C032TMX | NRND | SOIC | D | 16 | 2500 | TBD | Call TI | Call TI | -40 to 85 | DS90C032TM | |
| DS90C032TMX/NOPB | ACTIVE | SOIC | D | 16 | 2500 | Green (RoHS & no Sb/Br) | CU SN | Level-1-260C-UNLIM | -40 to 85 | DS90C032TM |  |

(1) The marketing status values are defined as follows:

ACTIVE: Product device recommended for new designs.

LIFEBUY: TI has announced that the device will be discontinued, and a lifetime-buy period is in effect.

NRND: Not recommended for new designs. Device is in production to support existing customers, but TI does not recommend using this part in a new design.

PREVIEW: Device has been announced but is not in production. Samples may or may not be available.

OBSELETE: TI has discontinued the production of the device.

(2) Eco Plan - The planned eco-friendly classification: Pb-Free (RoHS), Pb-Free (RoHS Exempt), or Green (RoHS & no Sb/Br) - please check <http://www.ti.com/productcontent> for the latest availability information and additional product content details.

TBD: The Pb-Free/Green conversion plan has not been defined.

Pb-Free (RoHS): TI's terms "Lead-Free" or "Pb-Free" mean semiconductor products that are compatible with the current RoHS requirements for all 6 substances, including the requirement that lead not exceed 0.1% by weight in homogeneous materials. Where designed to be soldered at high temperatures, TI Pb-Free products are suitable for use in specified lead-free processes.

Pb-Free (RoHS Exempt): This component has a RoHS exemption for either 1) lead-based flip-chip solder bumps used between the die and package, or 2) lead-based die adhesive used between the die and leadframe. The component is otherwise considered Pb-Free (RoHS compatible) as defined above.

Green (RoHS & no Sb/Br): TI defines "Green" to mean Pb-Free (RoHS compatible), and free of Bromine (Br) and Antimony (Sb) based flame retardants (Br or Sb do not exceed 0.1% by weight in homogeneous material)

(3) MSL, Peak Temp. - The Moisture Sensitivity Level rating according to the JEDEC industry standard classifications, and peak solder temperature.

(4) There may be additional marking, which relates to the logo, the lot trace code information, or the environmental category on the device.

(5) Multiple Device Markings will be inside parentheses. Only one Device Marking contained in parentheses and separated by a "~" will appear on a device. If a line is indented then it is a continuation of the previous line and the two combined represent the entire Device Marking for that device.

(6) Lead/Ball Finish - Orderable Devices may have multiple material finish options. Finish options are separated by a vertical ruled line. Lead/Ball Finish values may wrap to two lines if the finish value exceeds the maximum column width.

Important Information and Disclaimer: The information provided on this page represents TI's knowledge and belief as of the date that it is provided. TI bases its knowledge and belief on information provided by third parties, and makes no representation or warranty as to the accuracy of such information. Efforts are underway to better integrate information from third parties. TI has taken and

continues to take reasonable steps to provide representative and accurate information but may not have conducted destructive testing or chemical analysis on incoming materials and chemicals. TI and TI suppliers consider certain information to be proprietary, and thus CAS numbers and other limited information may not be available for release.

In no event shall TI's liability arising out of such information exceed the total purchase price of the TI part(s) at issue in this document sold by TI to Customer on an annual basis.

TAPE AND REEL INFORMATION

QUADRANT ASSIGNMENTS FOR PIN 1 ORIENTATION IN TAPE

*All dimensions are nominal

| Device | Package Type | Package Drawing | Pins | SPQ | Reel Diameter (mm) | Reel Width W1 (mm) | A0 (mm) | B0 (mm) | K0 (mm) | P1 (mm) | W (mm) | Pin1 Quadrant |
|------------------|--------------|-----------------|------|------|--------------------|--------------------|---------|---------|---------|---------|--------|---------------|
| DS90C032TMX | SOIC | D | 16 | 2500 | 330.0 | 16.4 | 6.5 | 10.3 | 2.3 | 8.0 | 16.0 | Q1 |
| DS90C032TMX/NOPB | SOIC | D | 16 | 2500 | 330.0 | 16.4 | 6.5 | 10.3 | 2.3 | 8.0 | 16.0 | Q1 |

TAPE AND REEL BOX DIMENSIONS

*All dimensions are nominal

| Device | Package Type | Package Drawing | Pins | SPQ | Length (mm) | Width (mm) | Height (mm) |
|------------------|--------------|-----------------|------|------|-------------|------------|-------------|
| DS90C032TMX | SOIC | D | 16 | 2500 | 367.0 | 367.0 | 35.0 |
| DS90C032TMX/NOPB | SOIC | D | 16 | 2500 | 367.0 | 367.0 | 35.0 |

D (R-PDSO-G16)

PLASTIC SMALL OUTLINE



4040047-6/M 06/11

- NOTES:
- A. All linear dimensions are in inches (millimeters).
 - B. This drawing is subject to change without notice.
 -  C. Body length does not include mold flash, protrusions, or gate burrs. Mold flash, protrusions, or gate burrs shall not exceed 0.006 (0,15) each side.
 -  D. Body width does not include interlead flash. Interlead flash shall not exceed 0.017 (0,43) each side.
 - E. Reference JEDEC MS-012 variation AC.

IMPORTANT NOTICE

Texas Instruments Incorporated (TI) reserves the right to make corrections, enhancements, improvements and other changes to its semiconductor products and services per JESD46, latest issue, and to discontinue any product or service per JESD48, latest issue. Buyers should obtain the latest relevant information before placing orders and should verify that such information is current and complete.

TI's published terms of sale for semiconductor products (<http://www.ti.com/sc/docs/stdterms.htm>) apply to the sale of packaged integrated circuit products that TI has qualified and released to market. Additional terms may apply to the use or sale of other types of TI products and services.

Reproduction of significant portions of TI information in TI data sheets is permissible only if reproduction is without alteration and is accompanied by all associated warranties, conditions, limitations, and notices. TI is not responsible or liable for such reproduced documentation. Information of third parties may be subject to additional restrictions. Resale of TI products or services with statements different from or beyond the parameters stated by TI for that product or service voids all express and any implied warranties for the associated TI product or service and is an unfair and deceptive business practice. TI is not responsible or liable for any such statements.

Buyers and others who are developing systems that incorporate TI products (collectively, "Designers") understand and agree that Designers remain responsible for using their independent analysis, evaluation and judgment in designing their applications and that Designers have full and exclusive responsibility to assure the safety of Designers' applications and compliance of their applications (and of all TI products used in or for Designers' applications) with all applicable regulations, laws and other applicable requirements. Designer represents that, with respect to their applications, Designer has all the necessary expertise to create and implement safeguards that (1) anticipate dangerous consequences of failures, (2) monitor failures and their consequences, and (3) lessen the likelihood of failures that might cause harm and take appropriate actions. Designer agrees that prior to using or distributing any applications that include TI products, Designer will thoroughly test such applications and the functionality of such TI products as used in such applications.

TI's provision of technical, application or other design advice, quality characterization, reliability data or other services or information, including, but not limited to, reference designs and materials relating to evaluation modules, (collectively, "TI Resources") are intended to assist designers who are developing applications that incorporate TI products; by downloading, accessing or using TI Resources in any way, Designer (individually or, if Designer is acting on behalf of a company, Designer's company) agrees to use any particular TI Resource solely for this purpose and subject to the terms of this Notice.

TI's provision of TI Resources does not expand or otherwise alter TI's applicable published warranties or warranty disclaimers for TI products, and no additional obligations or liabilities arise from TI providing such TI Resources. TI reserves the right to make corrections, enhancements, improvements and other changes to its TI Resources. TI has not conducted any testing other than that specifically described in the published documentation for a particular TI Resource.

Designer is authorized to use, copy and modify any individual TI Resource only in connection with the development of applications that include the TI product(s) identified in such TI Resource. NO OTHER LICENSE, EXPRESS OR IMPLIED, BY ESTOPPEL OR OTHERWISE TO ANY OTHER TI INTELLECTUAL PROPERTY RIGHT, AND NO LICENSE TO ANY TECHNOLOGY OR INTELLECTUAL PROPERTY RIGHT OF TI OR ANY THIRD PARTY IS GRANTED HEREIN, including but not limited to any patent right, copyright, mask work right, or other intellectual property right relating to any combination, machine, or process in which TI products or services are used. Information regarding or referencing third-party products or services does not constitute a license to use such products or services, or a warranty or endorsement thereof. Use of TI Resources may require a license from a third party under the patents or other intellectual property of the third party, or a license from TI under the patents or other intellectual property of TI.

TI RESOURCES ARE PROVIDED "AS IS" AND WITH ALL FAULTS. TI DISCLAIMS ALL OTHER WARRANTIES OR REPRESENTATIONS, EXPRESS OR IMPLIED, REGARDING RESOURCES OR USE THEREOF, INCLUDING BUT NOT LIMITED TO ACCURACY OR COMPLETENESS, TITLE, ANY EPIDEMIC FAILURE WARRANTY AND ANY IMPLIED WARRANTIES OF MERCHANTABILITY, FITNESS FOR A PARTICULAR PURPOSE, AND NON-INFRINGEMENT OF ANY THIRD PARTY INTELLECTUAL PROPERTY RIGHTS. TI SHALL NOT BE LIABLE FOR AND SHALL NOT DEFEND OR INDEMNIFY DESIGNER AGAINST ANY CLAIM, INCLUDING BUT NOT LIMITED TO ANY INFRINGEMENT CLAIM THAT RELATES TO OR IS BASED ON ANY COMBINATION OF PRODUCTS EVEN IF DESCRIBED IN TI RESOURCES OR OTHERWISE. IN NO EVENT SHALL TI BE LIABLE FOR ANY ACTUAL, DIRECT, SPECIAL, COLLATERAL, INDIRECT, PUNITIVE, INCIDENTAL, CONSEQUENTIAL OR EXEMPLARY DAMAGES IN CONNECTION WITH OR ARISING OUT OF TI RESOURCES OR USE THEREOF, AND REGARDLESS OF WHETHER TI HAS BEEN ADVISED OF THE POSSIBILITY OF SUCH DAMAGES.

Unless TI has explicitly designated an individual product as meeting the requirements of a particular industry standard (e.g., ISO/TS 16949 and ISO 26262), TI is not responsible for any failure to meet such industry standard requirements.

Where TI specifically promotes products as facilitating functional safety or as compliant with industry functional safety standards, such products are intended to help enable customers to design and create their own applications that meet applicable functional safety standards and requirements. Using products in an application does not by itself establish any safety features in the application. Designers must ensure compliance with safety-related requirements and standards applicable to their applications. Designer may not use any TI products in life-critical medical equipment unless authorized officers of the parties have executed a special contract specifically governing such use. Life-critical medical equipment is medical equipment where failure of such equipment would cause serious bodily injury or death (e.g., life support, pacemakers, defibrillators, heart pumps, neurostimulators, and implantables). Such equipment includes, without limitation, all medical devices identified by the U.S. Food and Drug Administration as Class III devices and equivalent classifications outside the U.S.

TI may expressly designate certain products as completing a particular qualification (e.g., Q100, Military Grade, or Enhanced Product). Designers agree that it has the necessary expertise to select the product with the appropriate qualification designation for their applications and that proper product selection is at Designers' own risk. Designers are solely responsible for compliance with all legal and regulatory requirements in connection with such selection.

Designer will fully indemnify TI and its representatives against any damages, costs, losses, and/or liabilities arising out of Designer's non-compliance with the terms and provisions of this Notice.

Looking for pricing, stock, or lifecycle information?

Click below to explore more details on WIN SOURCE:

 [View DS90C032TM/NOPB on WIN SOURCE](#)

 [Texas Instruments](#) Information

Optimize Your Supply Chain with WIN SOURCE Solutions

-  Global Sourcing Solution
-  Obsolete Management
-  Cost Control Management
-  Shortage Management
-  Alternative Solution
-  Excess Inventory Management