



**THE DATASHEET OF
CR4211S-150**



Self Powered AC Current Transducer

DIN RAIL / PANEL MOUNT, AVERAGE RMS



CR4210 CR4211

Single Element - .79" Window
2 to 600 AAC Input Range



CR4210S CR4211S

Single Element - 1.22" Window
5 to 200 AAC Input Range

The **CR4210** and **CR4211** Series Current Transducers are self powered. These transducers are calibrated to provide a 0-5 VDC and 0-10 VDC signal that is proportional to the average RMS input AC current. Designed for multi-point current sensing, these devices provide excellent features in a value package.

Applications

- Multi-point current sensing and control panels
- Remote current sensing
- Monitor motor faults
- Monitor heating elements
- Monitor lighting elements

Features

- 35mm DIN Rail or Panel Mount
- Available with 0 - 5 VDC or 0-10 VDC outputs
- Self powered, requires no external power source
- Use with external current transformers
- Low cost
- Connection diagram printed on case

Regulatory Agencies

- Recognized to meet UL 61010B-1
- Constructed to meet CAN/CSA-C22.2, No. 61010-1-2004
- Meets requirement of IEC 61010-1 and BS EN 61010-1

Transducers

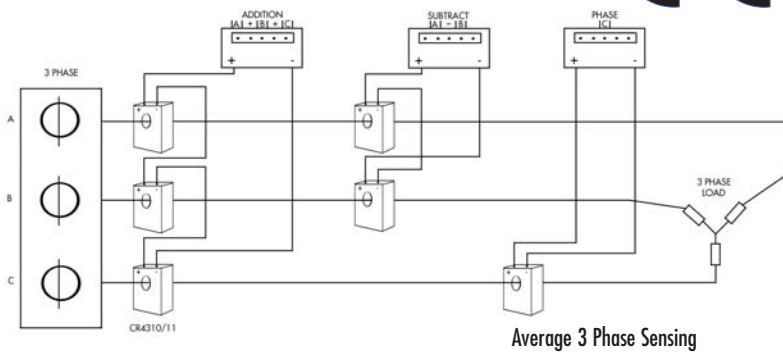

E199795

All single phase current transducers are available in split core design. Simply put an "S" at the end of the prefix*

I.E. CR4210S-10

* **Not UL Recognized**

PART NUMBERS			
CR4210(S)	-		Single element with 0 - 5 VDC output (split core design)
CR4211(S)	-		Single element with 0 - 10 VDC output (split core design)*
*CR4210S and CR4211S only available in ranges 20 amps and above			

Add suffix for input range

- 2** - 0-2 AAC
- 5** - 0-5 AAC
- 10** - 0-10 AAC
- 20** - 0-20 AAC
- 50** - 0-50 AAC
- 70** - 0-70 AAC
- 100** - 0-100 AAC
- 150** - 0-150 AAC
- 200** - 0-200 AAC

Ranges available up to and including 600 AAC



3500 Scarlet Oak Blvd. St. Louis MO USA 63122 V: 636-343-8518 F: 636-343-5119

Web: <http://www.crmagnetics.com>

34

E-mail: sales@crmagnetics.com



Self Powered AC Current Transducer

DIN RAIL / PANEL MOUNT, AVERAGE RMS

SPECIFICATIONS

Basic Accuracy:.....	0.5%	Cleaning:.....	Water-dampened cloth
Linearity:.....	10% to 100% FS	Output Load:.....	> or = 1 Meg Ω
Thermal Drift:.....	500 PPM/ $^{\circ}$ C	Response Time:.....	250 ms max., 0-90%FS
Operating Temperature:.....	0 $^{\circ}$ C to +60 $^{\circ}$ C	Relative Humidity:.....	5% to 95%, Non-Condensing
Installation Category:.....	CAT II	Supply Power:.....	Self powered (output voltage is obtained from current-sensing conductor)
Vibration Tested To:.....	IEC 60068-2-6,1995	Torque Specs:.....	3.0 inch lbs. (0.4Nm)
Pollution Degree:.....	2	Weight:.....	0.5 lbs.
Insulation Voltage:.....	2500 VDC		
Altitude:.....	2000 meter max.		
Frequency Range:.....	50Hz - 400Hz		
Calibration:.....	Average Sensing, RMS Calibrated		
MTBF:.....	Greater than 100 K Hours		

OUTLINE DRAWING



CONNECTION DIAGRAM

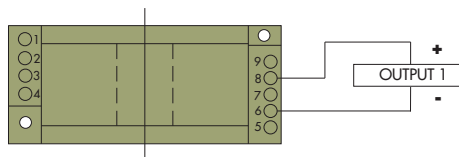

CR4210 Single Element 0 - 5 VDC Output

CR4211 Single Element 0 - 10 VDC Output

Request CR Magnetics Low & Medium Voltage Current Transformers Catalog.

NOTE: The building installation must have a switch or circuit-breaker that is in close proximity and within easy reach of the operator. The switch or circuit breaker shall be marked as the disconnecting device for the equipment.

Looking for pricing, stock, or lifecycle information?

Click below to explore more details on WIN SOURCE:

 [View CR4211S-150 on WIN SOURCE](#)

 [CR Magnetics Inc. Information](#)

Optimize Your Supply Chain with WIN SOURCE Solutions

-  Global Sourcing Solution
-  Obsolete Management
-  Cost Control Management
-  Shortage Management
-  Alternative Solution
-  Excess Inventory Management