



THE DATASHEET OF CR4220-15



Loop-Powered AC Current Transmitter

DIN RAIL / PANEL MOUNT, AVERAGE RMS

The **CR4200** Series, Current Transmitters produce a calibrated 4-20 mADC signal that is proportional to the average RMS input AC current. Designed for multi-point current sensing, these devices provide excellent features in a value package. The output signal is generated from a user supplied 24 VDC power supply within the output current loop.



CR4220

Single Element - .79" Window
0.5 to 50 AAC Input Range



CR4260

Two Element - .26" Window
0.5 to 30 AAC Input Range

Applications

- Multi-point current sensing and control panels
- Remote current sensing
- Monitor motor faults
- Monitor heating elements
- Monitor lighting elements

Features

- Relatively low cost
- 35mm DIN rail or panel mount
- High Accuracy
- Easy wiring
- Interfaces with most commercially available instrumentation
- Connection diagram printed on case

Regulatory Agencies

- Recognized to meet UL 61010B-1
- Constructed to meet CAN/CSA-C22.2, No. 61010-1-2004
- Meets requirement of IEC 61010-1 and BS EN 61010-1

C
Transducers

CR Magnetics has a wide selection of current transformers to extend the range of any part. Contact factory for more information.



All single phase current transducers are available in split core design. Simply put an "S" at the end of the prefix*
I.E. CR4220S-10
*** Not UL Recognized**

PART NUMBERS			
CR4220(S)	-		Single element with 4 - 20 mADC output (split core design)
CR4260	-		Two element with 4 - 20 mADC output*
*Two element transducers are only available in ranges of 0.5 to 30 AAC			

Add suffix for input range

- 5** - 0- 5 AAC
- 10** - 0-10 AAC
- 15** - 0-15 AAC
- 20** - 0-20 AAC
- 25** - 0-25 AAC
- 30** - 0-30 AAC
- 40** - 0-40 AAC
- 50** - 0-50 AAC

Ranges available up to and including 600 AAC

Loop-Powered AC Current Transmitter

DIN RAIL / PANEL MOUNT, AVERAGE RMS

SPECIFICATIONS

Basic Accuracy:.....	0.5%	MTBF:.....	Greater than 100 K
Linearity:.....	10% to 100% FS	Cleaning:.....	Water-dampened cloth
Thermal Drift:.....	500 PPM/°C	Output Load:.....	0 to 500 Ω
Operating Temperature:.....	0°C to +60°C	Response Time:.....	250 ms max., 0-90%FS
Installation Category:.....	CAT II	Relative Humidity:.....	5% to 95%, Non-Condensing
Vibration Tested To:.....	IEC 60068-2-6,1995	Supply Power:.....	Loop Voltage 24 Vdc
Pollution Degree:.....	2	Compliance Voltage:.....	16 to 28 Vdc
Insulation Voltage:.....	2500 VDC	Torque Specs:.....	3.0 inch lbs. (0.4Nm)
Altitude:.....	2000 meter max.	Weight:.....	0.5 lbs.
Frequency Range:.....	50Hz - 400 Hz		
Calibration:.....	Average Sensing, RMS Calibrated		

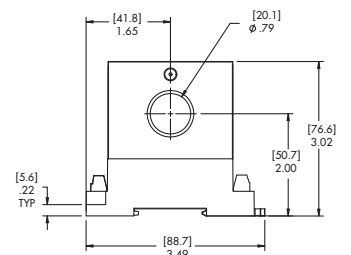
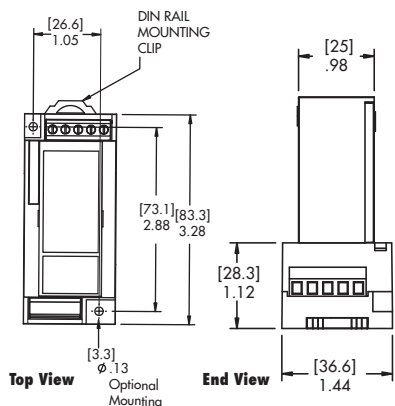

CR4220

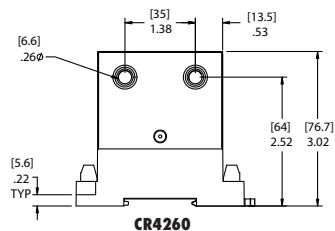

CR4260

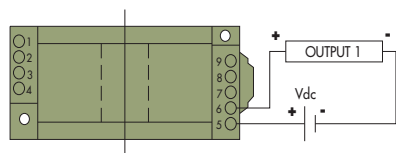

CR4220

One Element - 4 - 20 mADC Output

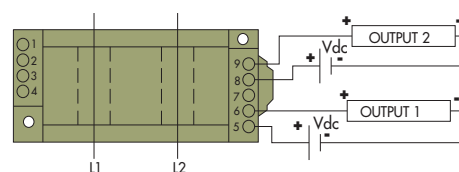

CR4260

Two Element 4 - 20 mADC Output

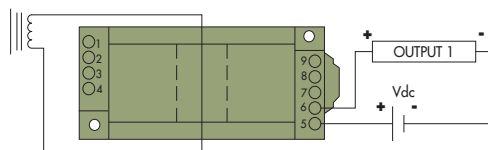

CR4220

One Element with external current transformer *

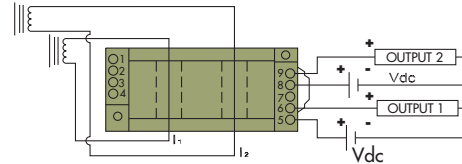

CR4260

Two Element with external current transformer *

*Request CR Magnetics Low & Medium Voltage Current Transformers Catalog.

OUTLINE DRAWING

CONNECTION DIAGRAM

NOTE: The building installation must have a switch or circuit-breaker that is in close proximity and within easy reach of the operator. The switch or circuit breaker shall be marked as the disconnecting device for the equipment.

Looking for pricing, stock, or lifecycle information?

Click below to explore more details on WIN SOURCE:

 [View CR4220-15 on WIN SOURCE](#)

 [CR Magnetics Inc. Information](#)

Optimize Your Supply Chain with WIN SOURCE Solutions

-  Global Sourcing Solution
-  Obsolete Management
-  Cost Control Management
-  Shortage Management
-  Alternative Solution
-  Excess Inventory Management