



**THE DATASHEET OF
CR4411-150**



Average RMS AC Current Transducer

DIN RAIL / PANEL MOUNT, AVERAGE RMS



CR4410 CR4411 CR4420

Single Element - .79" Window
0.5 to 600 AAC Input Range



CR4450 CR4460

Two Element - .26" Window
0.5 to 30 AAC Input Range



CR4470 CR4480

Three Element - .26" Window
0.5 to 30 AAC Input Range

Use a 5 Amp Secondary Current Transformer to extend the ranges of all CR Magnetics Current Transducers



The **CR4400** Series, Current Transducers and Transmitters are designed to produce a DC output signal that is proportional to the average RMS input AC current. Designed for multi-point current sensing, these devices provide excellent features in a value package .

Applications

- Multi-point current sensing and control panels
- Monitor motor faults
- Monitor heating elements
- Monitor lighting elements

Features

- Low cost
 - DIN rail or panel mount
 - Available with 0-5 VDC, 0-10VDC or 4-20 mADC output
 - High Accuracy
 - Interfaces with most commercially available instrumentation
- Connection diagram printed on case

Regulatory Agencies

- Recognized to meet UL 61010B-1
- Constructed to meet CAN/CSA-C22.2, No. 61010-1-2004
- Meets requirement of IEC 61010-1 and BS EN 61010-1



All single phase current transducers are available in split core design. Simply put an "S" at the end of the prefix*
I.E. CR4410S-10
*** Not UL Recognized**

PART NUMBERS

CR4410(S)	-		Single element with 0 - 5 VDC output (split core design)
CR4411(S)	-		Single element with 0 - 10 VDC output (split core design)*
CR4420(S)	-		Single element with 4 - 20 mADC output (split core design)
CR4450	-		Two element with 0 - 5 VDC output *
CR4460	-		Two element with 4 to 20 mADC output *
CR4470	-		Three element with 0 - 5 VDC output *
CR4480	-		Three element with 4 - 20 mADC output *

Two and three element transducers are available only in ranges of 0.5 to 30 AAC

Add suffix for input range

- 5** - 0-5 AAC
- 10** - 0-10 AAC
- 15** - 0-15 AAC
- 20** - 0-20 AAC
- 25** - 0-25 AAC
- 30** - 0-30 AAC
- 40** - 0-40 AAC
- 50** - 0-50 AAC
- 75** - 0-75 AAC
- 100** - 0-100 AAC
- 150** - 0-150 AAC

Ranges available up to and including 600 AAC

Transducers

SPECIFICATIONS

Basic Accuracy:.....	0.5%	Cleaning:.....	Water-dampened cloth
Linearity:.....	10% to 100% FS	Relative Humidity:.....	5% to 95%, Non-Condensing
Thermal Drift:.....	500 PPM/°C	Supply Voltage:.....	24 VDC ±10%
Operating Temperature:.....	0°C to +60°C	Supply Current:	
Installation Category:.....	CAT II	CR4410/11.....	Typical 20mA Max 40mA
Vibration Tested To:.....	IEC 60068-2-6,1995	CR4420.....	Typical 25mA Max 45mA
Pollution Degree:.....	2	CR4450.....	Typical 20mA Max 75mA
Response Time:.....	250 ms max., 0-90% FS	CR4460.....	Typical 40mA Max 90mA
MTBF:.....	Greater than 100 K hours	CR4470.....	Typical 25mA Max 110mA
Altitude:.....	2000 meter max.	CR4480.....	Typical 55mA Max 120mA
Calibration:.....	Average Sensing, RMS Calibrated	CR4410S.....	Typical ---mA Max ----mA
Insulation Voltage:.....	2500 VDC	CR4420S.....	Typical ---mA Max ----mA
Power Source:.....	24 VDC	Torque Specs:.....	3.0 inch lbs. (0.4Nm)
Frequency Range:.....	50Hz - 400Hz	Weight:.....	0.5 lbs.
Output Load:.....	4-20 mADC - 0 to 500 Ω		
	0-5 VDC - 2K Ω or Greater		

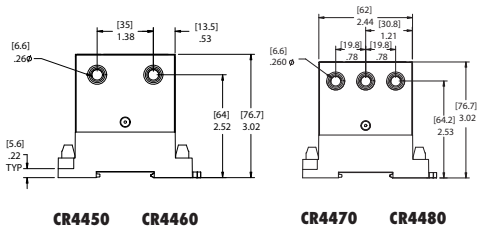
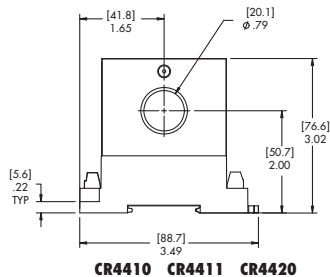
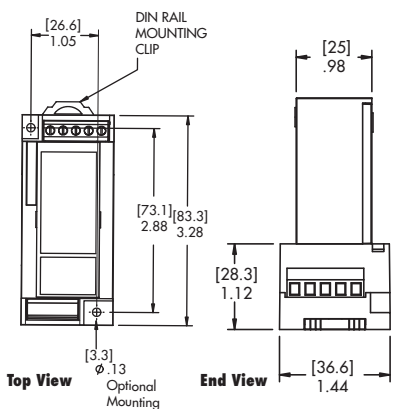

OUTLINE DRAWING

NOTE: The building installation must have a switch or circuit-breaker that is in close proximity and within easy reach of the operator. The switch or circuit breaker shall be marked as the disconnecting device for the equipment.

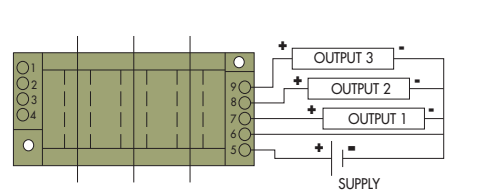
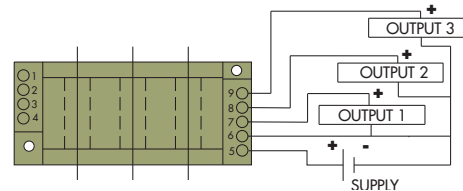
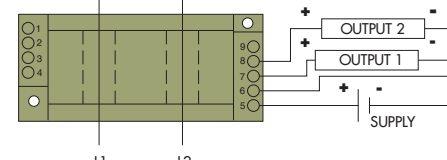
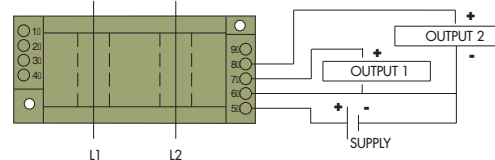
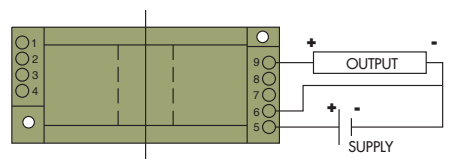
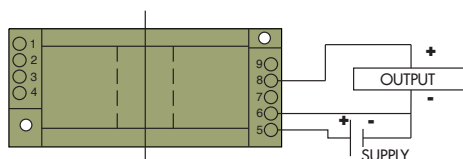

*Request CR Magnetics Low & Medium Voltage Current Transformers Catalog.

CONNECTION DIAGRAM

Looking for pricing, stock, or lifecycle information?

Click below to explore more details on WIN SOURCE:

 [View CR4411-150 on WIN SOURCE](#)

 [CR Magnetics Inc. Information](#)

Optimize Your Supply Chain with WIN SOURCE Solutions

-  Global Sourcing Solution
-  Obsolete Management
-  Cost Control Management
-  Shortage Management
-  Alternative Solution
-  Excess Inventory Management