



**THE DATASHEET OF
CR4411-75**



Average RMS AC Current Transducer

DIN RAIL / PANEL MOUNT, AVERAGE RMS



CR4410 CR4411 CR4420

Single Element - .79" Window
0.5 to 600 AAC Input Range



CR4450 CR4460

Two Element - .26" Window
0.5 to 30 AAC Input Range



CR4470 CR4480

Three Element - .26" Window
0.5 to 30 AAC Input Range

Use a 5 Amp Secondary Current Transformer to extend the ranges of all CR Magnetics Current Transducers



The **CR4400** Series, Current Transducers and Transmitters are designed to produce a DC output signal that is proportional to the average RMS input AC current. Designed for multi-point current sensing, these devices provide excellent features in a value package .

Applications

- Multi-point current sensing and control panels
- Monitor motor faults
- Monitor heating elements
- Monitor lighting elements

Features

- Low cost
 - DIN rail or panel mount
 - Available with 0-5 VDC, 0-10VDC or 4-20 mADC output
 - High Accuracy
 - Interfaces with most commercially available instrumentation
- Connection diagram printed on case

Regulatory Agencies

- Recognized to meet UL 61010B-1
- Constructed to meet CAN/CSA-C22.2, No. 61010-1-2004
- Meets requirement of IEC 61010-1 and BS EN 61010-1



All single phase current transducers are available in split core design. Simply put an "S" at the end of the prefix*
I.E. CR4410S-10
*** Not UL Recognized**

PART NUMBERS

CR4410(S)	-		Single element with 0 - 5 VDC output (split core design)
CR4411(S)	-		Single element with 0 - 10 VDC output (split core design)*
CR4420(S)	-		Single element with 4 - 20 mADC output (split core design)
CR4450	-		Two element with 0 - 5 VDC output *
CR4460	-		Two element with 4 to 20 mADC output *
CR4470	-		Three element with 0 - 5 VDC output *
CR4480	-		Three element with 4 - 20 mADC output *

Two and three element transducers are available only in ranges of 0.5 to 30 AAC

Add suffix for input range

- 5** - 0-5 AAC
- 10** - 0-10 AAC
- 15** - 0-15 AAC
- 20** - 0-20 AAC
- 25** - 0-25 AAC
- 30** - 0-30 AAC
- 40** - 0-40 AAC
- 50** - 0-50 AAC
- 75** - 0-75 AAC
- 100** - 0-100 AAC
- 150** - 0-150 AAC

Ranges available up to and including 600 AAC

Transducers

SPECIFICATIONS

Basic Accuracy:.....	0.5%	Cleaning:.....	Water-dampened cloth
Linearity:.....	10% to 100% FS	Relative Humidity:.....	5% to 95%, Non-Condensing
Thermal Drift:.....	500 PPM/°C	Supply Voltage:.....	24 VDC ±10%
Operating Temperature:.....	0°C to +60°C	Supply Current:	
Installation Category:.....	CAT II	CR4410/11.....	Typical 20mA Max 40mA
Vibration Tested To:.....	IEC 60068-2-6,1995	CR4420.....	Typical 25mA Max 45mA
Pollution Degree:.....	2	CR4450.....	Typical 20mA Max 75mA
Response Time:.....	250 ms max., 0-90% FS	CR4460.....	Typical 40mA Max 90mA
MTBF:.....	Greater than 100 K hours	CR4470.....	Typical 25mA Max 110mA
Altitude:.....	2000 meter max.	CR4480.....	Typical 55mA Max 120mA
Calibration:.....	Average Sensing, RMS Calibrated	CR4410S.....	Typical ---mA Max ----mA
Insulation Voltage:.....	2500 VDC	CR4420S.....	Typical ---mA Max ----mA
Power Source:.....	24 VDC	Torque Specs:.....	3.0 inch lbs. (0.4Nm)
Frequency Range:.....	50Hz - 400Hz	Weight:.....	0.5 lbs.
Output Load:.....	4-20 mADC - 0 to 500 Ω		
	0-5 VDC - 2K Ω or Greater		

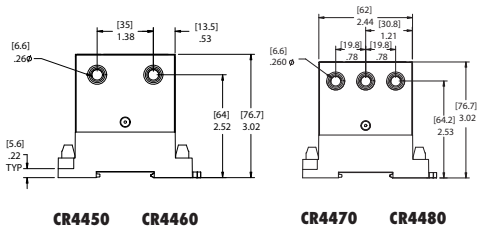
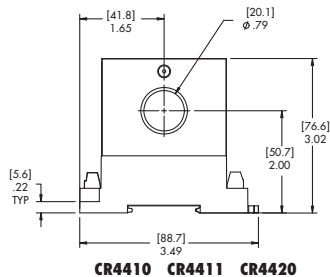
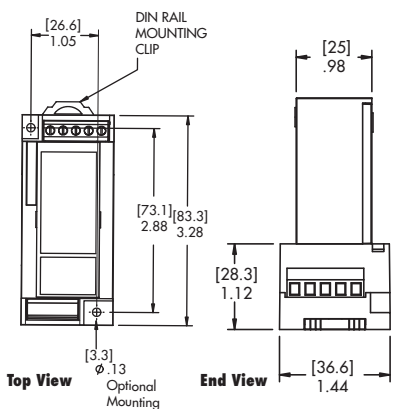

OUTLINE DRAWING

NOTE: The building installation must have a switch or circuit-breaker that is in close proximity and within easy reach of the operator. The switch or circuit breaker shall be marked as the disconnecting device for the equipment.

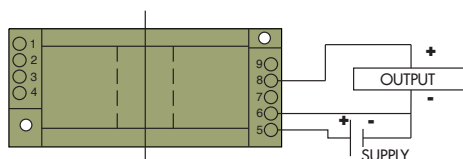

CR4410 One Element 0 - 5 VDC Output
CR4411 One Element 0 - 10 VDC Output

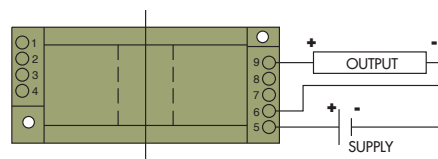

CR4420 One Element 4 - 20 mADC Output

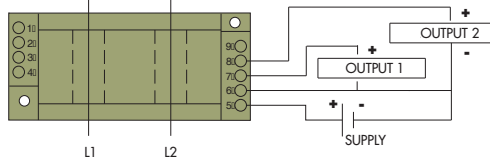

CR4450 Two Element 0 - 5 VDC Output

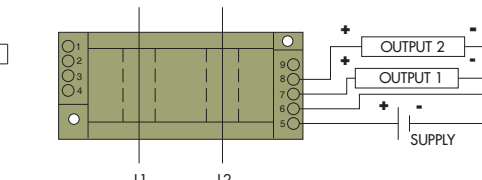

CR4460 Two Element 4 - 20 mADC Output

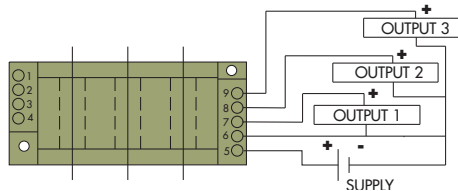

CR4470 Three Element 0 - 5 VDC Output

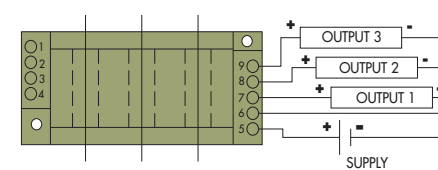



CR4480 Three Element 4 - 20 mADC Output

*Request CR Magnetics Low & Medium Voltage Current Transformers Catalog.

CONNECTION DIAGRAM

Looking for pricing, stock, or lifecycle information?

Click below to explore more details on WIN SOURCE:

-  [View CR4411-75 on WIN SOURCE](#)
-  [CR Magnetics Inc. Information](#)

Optimize Your Supply Chain with WIN SOURCE Solutions

-  Global Sourcing Solution
-  Obsolete Management
-  Cost Control Management
-  Shortage Management
-  Alternative Solution
-  Excess Inventory Management