



**THE DATASHEET OF  
CR5210-20**



# DC Current Transducer

## DIN RAIL / PANEL MOUNT



CR5210 CR5211 CR5220

Single Element - .79" Window  
0.1 to 600 ADC Input Range



CR5210S CR5211S CR5220S

Single Element - 1.2" Window  
20 to 600 ADC Input Range

The **CR5200** Series, DC Current Transducers are designed to provide a DC signal which is proportional to a DC sensed current. These devices are designed for direct current only, targeting them towards general and daily applications. The ranges 2 to 20 Amp Solid Core Versions, utilize an advanced Magnetic Modulator technology. The ranges 20 amps Split Core and > 20ADC Solid Core, utilize Hall Effect technology.

### Applications

Battery chargers and systems  
DC motor drives  
Power supply management  
Mobile applications

### Features

Closed loop sensing for accuracy  
35mm DIN rail or panel mount  
Available with  $\pm 5$  VDC,  $\pm 10$  VDC or 4 - 20 mADC outputs  
Non-contact DC current sensing  
Connection diagram printed on case

### Regulatory Agencies

Constructed to meet UL 61010B-1  
Constructed to meet CAN/CSA-C22.2, No. 61010-1-2004  
Meets requirement of IEC 61010-1 and BS EN 61010-1

Transducers



Contact Factory for Custom  $\pm 5$  VDC,  $\pm 10$  VDC or 4 - 20 mADC Output Options

All single phase current transducers  $>$  or  $=$  20ADC Full Scale Input Range, are available in split core design. Simply put an "S" at the end of the prefix\*

I.E. CR5210S-30

PART NUMBERS			
CR5210(S)	▪		Single Element with $\pm 5$ VDC output (split core design)
CR5211(S)	▪		Single Element with $\pm 10$ VDC output (split core design)
CR5220(S)	▪		Single Element with 4 - 20 mADC output (split core design)
NOTE: DC Split Core Transducers Available in 20 Amps and Higher			
NOTE: CR5200 Series is available with 12V Power Supply. Use same application as 24V Power Supply.			
Example Part Number: CR5210-300-12V			

- Add suffix for input range
- 2** - 0-2 ADC
  - 5** - 0-5 ADC
  - 10** - 0-10 ADC
  - 20** - 0-20 ADC
  - 30** - 0-30 ADC
  - 50** - 0-50 ADC
  - 75** - 0-75 ADC
  - 100** - 0-100 ADC
  - 150** - 0-150 ADC
  - 300** - 0-300 ADC

Ranges available up to and including 600 ADC

# DC Current Transducer

## DIN RAIL / PANEL MOUNT

### SPECIFICATIONS

Basic Accuracy:.....	1.0 %	MTBF:.....	Greater than 100 K hours
Linearity:.....	10% to 100% FS	Output Load:.....	4-20 mADC - 0 to 500 $\Omega$ 0-5 VDC - 2K $\Omega$ or Greater
Thermal Drift:.....	500 PPM/ $^{\circ}$ C	Relative Humidity:.....	5% to 95%, Non-Condensing
Operating Temperature:.....	0 $^{\circ}$ C to +50 $^{\circ}$ C	Supply Current:	
Installation Category:.....	CAT II	CR5210/11:.....	Typical 35mA      Max 40mA
Isolation Voltage:.....	3500KVRMS/1mA/1Sec	CR5210/11S:.....	Typical 30mA      Max 35mA
Vibration Tested To:.....	IEC 60068-2-6,1995	CR5220:.....	Typical 60mA      Max 100mA
Pollution Degree:.....	2	CR5220S:.....	Typical 40mA      Max 50mA
Response Time: .....	250 ms	Torque Specs.:.....	3.0 inch lbs. (0.4Nm)
Altitude:.....	2000 meter max.	Weight:.....	0.5 lbs.
Insulation Voltage:.....	2500 VDC		
Supply Voltage:.....	24 VDC $\pm$ 10%		
Frequency Range:.....	DC Only		
Cleaning:.....	Water-dampened cloth		

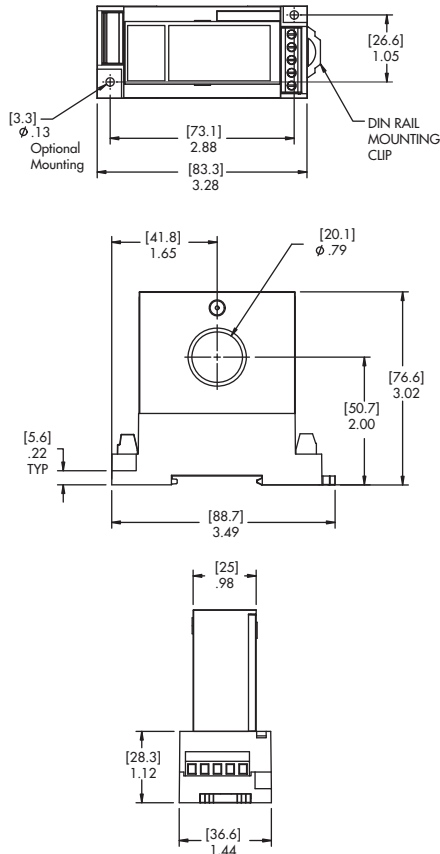

**OUTLINE DRAWING**



**CONNECTION DIAGRAM**

NOTE: The building installation must have a switch or circuit-breaker that is in close proximity and within easy reach of the operator. The switch or circuit breaker shall be marked as the disconnecting device for the equipment.

## Looking for pricing, stock, or lifecycle information?

Click below to explore more details on WIN SOURCE:

 [View CR5210-20 on WIN SOURCE](#)

 [CR Magnetics Inc. Information](#)

## Optimize Your Supply Chain with WIN SOURCE Solutions

-  Global Sourcing Solution
-  Obsolete Management
-  Cost Control Management
-  Shortage Management
-  Alternative Solution
-  Excess Inventory Management