



**THE DATASHEET OF
CR5210-300**



DC Current Transducer

DIN RAIL / PANEL MOUNT



CR5210 CR5211 CR5220

Single Element - .79" Window
0.1 to 600 ADC Input Range



CR5210S CR5211S CR5220S

Single Element - 1.2" Window
20 to 600 ADC Input Range

The **CR5200** Series, DC Current Transducers are designed to provide a DC signal which is proportional to a DC sensed current. These devices are designed for direct current only, targeting them towards general and daily applications. The ranges 2 to 20 Amp Solid Core Versions, utilize an advanced Magnetic Modulator technology. The ranges 20 amps Split Core and > 20ADC Solid Core, utilize Hall Effect technology.

Applications

Battery chargers and systems
DC motor drives
Power supply management
Mobile applications

Features

Closed loop sensing for accuracy
35mm DIN rail or panel mount
Available with ± 5 VDC, ± 10 VDC or 4 - 20 mADC outputs
Non-contact DC current sensing
Connection diagram printed on case

Regulatory Agencies

Constructed to meet UL 61010B-1
Constructed to meet CAN/CSA-C22.2, No. 61010-1-2004
Meets requirement of IEC 61010-1 and BS EN 61010-1

Transducers



Contact Factory for Custom ± 5 VDC, ± 10 VDC or 4 - 20 mADC Output Options

All single phase current transducers $>$ or $=$ 20ADC Full Scale Input Range, are available in split core design. Simply put an "S" at the end of the prefix*

I.E. CR5210S-30

PART NUMBERS			
CR5210(S)	▪		Single Element with ± 5 VDC output (split core design)
CR5211(S)	▪		Single Element with ± 10 VDC output (split core design)
CR5220(S)	▪		Single Element with 4 - 20 mADC output (split core design)
NOTE: DC Split Core Transducers Available in 20 Amps and Higher			
NOTE: CR5200 Series is available with 12V Power Supply. Use same application as 24V Power Supply.			
Example Part Number: CR5210-300-12V			

- Add suffix for input range
- 2** - 0-2 ADC
 - 5** - 0-5 ADC
 - 10** - 0-10 ADC
 - 20** - 0-20 ADC
 - 30** - 0-30 ADC
 - 50** - 0-50 ADC
 - 75** - 0-75 ADC
 - 100** - 0-100 ADC
 - 150** - 0-150 ADC
 - 300** - 0-300 ADC

Ranges available up to and including 600 ADC

DC Current Transducer

DIN RAIL / PANEL MOUNT

SPECIFICATIONS

Basic Accuracy:.....	1.0 %	MTBF:.....	Greater than 100 K hours
Linearity:.....	10% to 100% FS	Output Load:.....	4-20 mADC - 0 to 500 Ω 0-5 VDC - 2K Ω or Greater
Thermal Drift:.....	500 PPM/ $^{\circ}$ C	Relative Humidity:.....	5% to 95%, Non-Condensing
Operating Temperature:.....	0 $^{\circ}$ C to +50 $^{\circ}$ C	Supply Current:	
Installation Category:.....	CAT II	CR5210/11:.....	Typical 35mA Max 40mA
Isolation Voltage:.....	3500KVRMS/1mA/1Sec	CR5210/11S:.....	Typical 30mA Max 35mA
Vibration Tested To:.....	IEC 60068-2-6,1995	CR5220:.....	Typical 60mA Max 100mA
Pollution Degree:.....	2	CR5220S:.....	Typical 40mA Max 50mA
Response Time:	250 ms	Torque Specs.:.....	3.0 inch lbs. (0.4Nm)
Altitude:.....	2000 meter max.	Weight:.....	0.5 lbs.
Insulation Voltage:.....	2500 VDC		
Supply Voltage:.....	24 VDC \pm 10%		
Frequency Range:.....	DC Only		
Cleaning:.....	Water-dampened cloth		

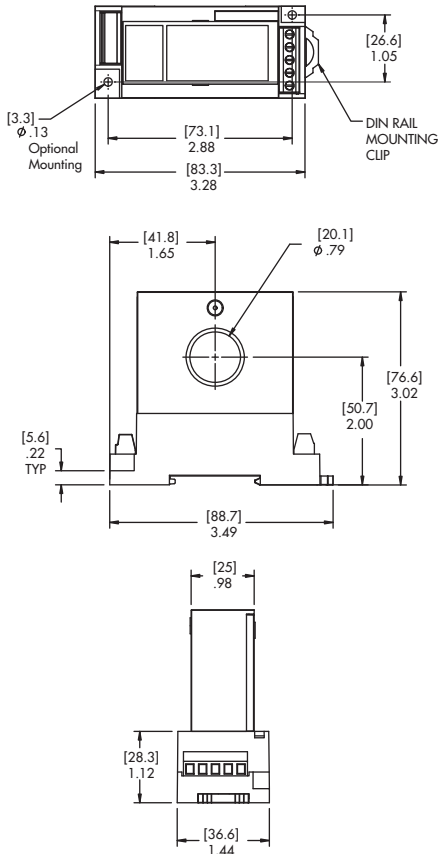

OUTLINE DRAWING



CONNECTION DIAGRAM

NOTE: The building installation must have a switch or circuit-breaker that is in close proximity and within easy reach of the operator. The switch or circuit breaker shall be marked as the disconnecting device for the equipment.

Looking for pricing, stock, or lifecycle information?

Click below to explore more details on WIN SOURCE:

 [View CR5210-300 on WIN SOURCE](#)

 [CR Magnetics Inc. Information](#)

Optimize Your Supply Chain with WIN SOURCE Solutions

-  Global Sourcing Solution
-  Obsolete Management
-  Cost Control Management
-  Shortage Management
-  Alternative Solution
-  Excess Inventory Management