



**THE DATASHEET OF
CR5410-20**



AC/DC Hall Effect Current Transducer

DIN RAIL / PANEL MOUNT, TRACING OUTPUT



Single Element - .79" Window
20 TO 600 AAC/DC Input Range

The **CR5400** Series, AC/DC Hall Effect Current Transducers, are designed to provide a bipolar output that proportionally reflects (traces) the waveform of the input current. These devices are specifically targeted to be used in applications where multi-mode current sensing is required.

Applications

Inverter and multi-frequency drives
Multi-mode ground paths carrying both AC and DC signals
Feed back loop building block

Features

Output isolated from input
Non-contact current sensing
35mm DIN Rail or Panel Mount
Connection diagram printed on case

Regulatory Agencies

Constructed to meet UL 61010B-1
Constructed to meet CAN/CSA-C22.2, No. 61010-1-2004
Meets requirement of IEC 61010-1 and BS EN 61010-1

C
Transducers

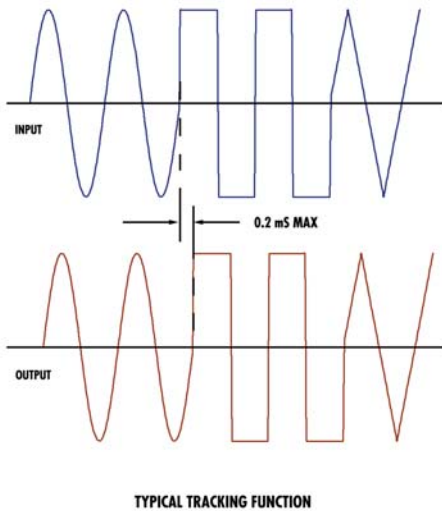

All single phase current transducers are available in split core design. Simply put an "S" at the end of the prefix*
I.E. CR5410S-30

PART NUMBERS			
CR5410(S)	-		Single Element with ± 5 VAC/DC output (split core design)
CR5411(S)	-		Single Element with ± 10 VAC/DC output (split core design)
NOTE: AC/DC Split Core Transducers Available in 20 Amps and Higher			

□ Add suffix for input range

- 20** - ± 20 AAC/ADC
- 30** - ± 30 AAC/ADC
- 50** - ± 50 AAC/ADC
- 75** - ± 75 AAC/ADC
- 100** - ± 100 AAC/ADC
- 150** - ± 150 AAC/ADC
- 300** - ± 300 AAC/ADC

Ranges available up to and including 600 AAC/ADC

AC/DC Hall Effect Current Transducer

DIN RAIL / PANEL MOUNT, TRACING OUTPUT

SPECIFICATIONS

Basic Accuracy:.....	1.0 %	Frequency Range:.....	DC to 4 KHz
Linearity:.....	10% to 100% FS	Output:.....	±5 Vac/DC or ±10 Vac/DC
Thermal Drift:.....	500 PPM/°C	Output Load:.....	2 K Ω or greater
Operating Temperature:.....	0°C to +50°C	Relative Humidity:.....	5% to 95%, Non-Condensing
Installation Category:.....	CAT II	Supply Current:	
Vibration Tested To:.....	IEC 60068-2-6,1995	CR5410:.....	Typical 35mA Max 40mA
Pollution Degree:.....	2	CR5410S:.....	Typical 30mA Max 35mA
Altitude:.....	2000 meter max.	Torque Specs:.....	3.0 inch lbs. (0.4Nm)
Insulation Voltage:.....	2500 VDC	Weight:.....	0.5 lbs.
Cleaning:.....	Water-dampened cloth		
MTBF:.....	Greater than 100K hours		
Supply Voltage:.....	24 VDC ±10%		

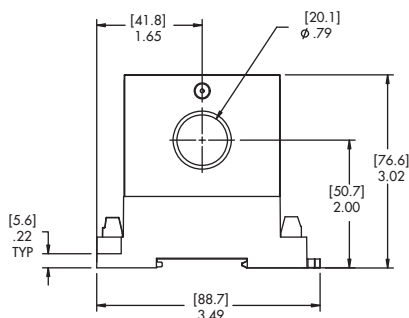

OUTLINE DRAWING

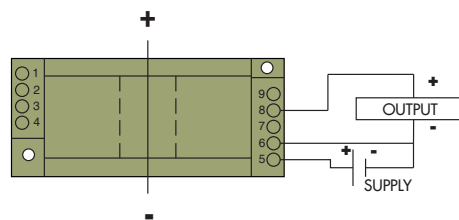

CR5410 ±5 VAC/VDC Output
CR5411 ±10 VAC/VDC Output

CONNECTION DIAGRAM



Power Supply

NOTE: The building installation must have a switch or circuit-breaker that is in close proximity and within easy reach of the operator. The switch or circuit breaker shall be marked as the disconnecting device for the equipment.

Looking for pricing, stock, or lifecycle information?

Click below to explore more details on WIN SOURCE:

 [View CR5410-20 on WIN SOURCE](#)

 [CR Magnetics Inc. Information](#)

Optimize Your Supply Chain with WIN SOURCE Solutions

-  Global Sourcing Solution
-  Obsolete Management
-  Cost Control Management
-  Shortage Management
-  Alternative Solution
-  Excess Inventory Management