



**THE DATASHEET OF  
CRD4150-15**



# Data Stream RS485 Digital Current Transducer

## DIN RAIL / PANEL MOUNT



**CRD4110**

Single Element - .26" (6.5) Window  
1 to 25 AAC Input Range



**CRD4150**

Two Element - .26" (6.5) Window  
1 to 25 AAC Input Range



**CRD4170**

Three Element - .26" (6.5) Window  
1 to 25 AAC Input Range

The **CRD4100** Series Data Stream Digital Current Transducers are designed for applications where AC current waveforms are not purely sinusoidal. The digital technology is used to measure voltage, current, power frequency and energy in single and three phase designs. The data is streamed over an RS485 IEEE bus which enables multiple transducers to communicate thru a single master connection. These advanced sensors are ideal for entire plant or zone monitoring. Also, the communication algorithm can be pre-ordered with ASCII based control or modified MODBUS based control.

### Sensing

True RMS Current, Each Phase

### Applications

Sub-Metering  
Motor Loads  
Uninterruptible Power Systems  
Remote Monitoring  
Load Shedding  
Energy Management

### Features

35mm DIN Rail or Panel Mount  
Red LED - Flashes when Power is Connected  
Red & Green LED Flash during Communication  
24 VDC powered  
Use with external current transformers  
Highest precision available  
Connection diagram printed on case

### Regulatory Agencies



CR Magnetics has a wide selection of Current and Potential Transformers to extend the range of any part. See Sections F & G for details.

## PART NUMBERS

<b>CRD4110</b>	-		Single Element, AC Current RS485 Digital Transducer
<b>CRD4150</b>	-		Two Element, AC Current RS485 Digital Transducer
<b>CRD4170</b>	-		Three Element, AC Current RS485 Digital Transducer

**1** - 0-1 AAC  
**5** - 0-5 AAC  
**15** - 0-15 AAC  
**25** - 0-25 AAC  
 Above 30 AAC must use 5 amp CT

**Note: Add an M at the end for MODBUS CRD4110-5-M**

# RS485 Digital Current Transducer

## SPECIFICATIONS

Basic Accuracy: .....0.5%	Torque Specifications: .....3.0 inch lbs (0.4Nm)
Calibration: .....True RMS Sensing	Response Time: .....250 ms. max. 0-90% FS
Thermal Drift: .....500 PPM/°C	Relative Humidity:.....5% to 95%, Non-Condensing
Operating Temperature <sub>1</sub> : .....0°C to +60°C	Output Resolution: .....16 bit
Installation Category: .....CAT II	Transducer fanout on common bus: .....64 max.
Vibration Tested To: .....IEC 60068-2-6,1995	Baud Rate <sub>3</sub> : .....1200, 2400, 4800, 9600,19.2K .bps
Pollution Degree: .....2	A/D Conversion Type: .....4th order Delta Sigma
Insulation Voltage: .....2500 VDC	Device Address <sub>3</sub> : .....00 to FF
Altitude: .....2000 meter max	Data Format: .....ASCII
Frequency Range: .....45Hz ~ 65Hz	Supply Current:.....Typical 30mA Max 30mA
MTBF: .....Greater than 100K hours	Weight:.....0.5 lbs.
Cleaning: .....Water-dampened cloth	
Supply Voltage <sub>2</sub> : .....24 VDC ±10%	
1) RH 5% to 95%, non-condensing 2) 0.4% max. ripple Vpp	no flow control, 1 stop bit
3) Factory default settings: address 01, baud rate 9600, no parity,	

Data Stream

B

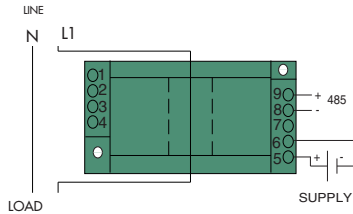

**CRD4110** Single Element, 2-Wire

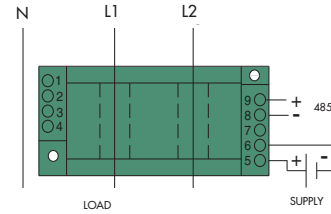

**CRD4150** Dual Element, 3-Wire

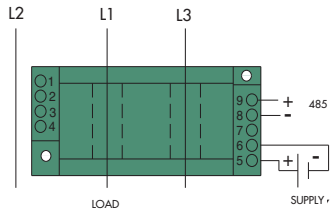

**CRD4150** Dual Element, 3-Wire

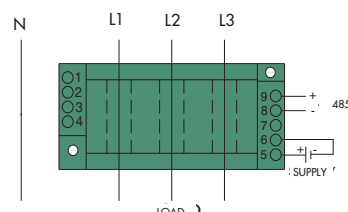

**CRD4170** 3 Element, 4-Wire

## Connection Diagram

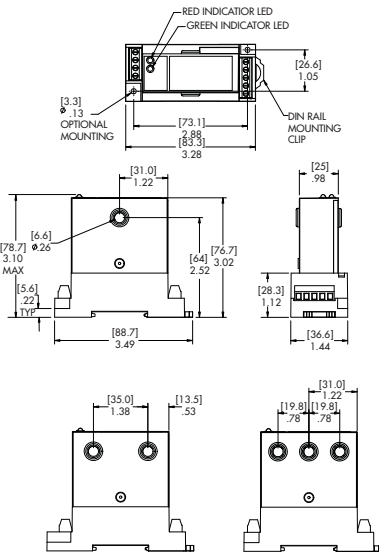

**OUTLINE DRAWING**

## CRD485-232 RS485 to RS232 Converter Accessory Connect PC to RS485 Bus

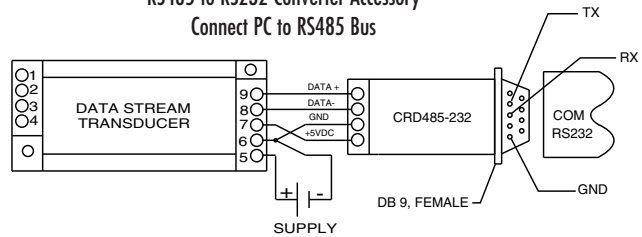

## ASCII Simplified Programming Commands

A simplified data structure is used with only 6 commands required for full control of the transducer. Commands are : Read Transducer Name, Read Configuration, Set Configuration, Read Measurements, Read Energy Totalizer and Clear Energy Totalizer. For illustration, the following commands are used to read data from a CRD5170 3 Phase, 4 Wire Transducer with a device address of 00.

**Command Transducer to Read Data:** #00A<cr>

**Transducers Response:** >+[% FS Voltage<sub>L1-N</sub>]+[% FS Current<sub>L1</sub>]+[% FS Voltage<sub>L2-N</sub>]+[% FS Current<sub>L2</sub>]+[% FS Voltage<sub>L3-N</sub>]+[% FS Current<sub>L3</sub>].[+/- % FS Power][+/- % FS VARS][+/-Power Factor][Frequency]<cr>

**Command Transducer to Read Energy Totalizer:** #00W<cr>

**Transducer Responds:** 01[+/-KWHr][+/-KVHr][check sum]<cr>

**Note:** This is for illustration purposes only, See Applications Guides (Section I for complete instructions.

## Looking for pricing, stock, or lifecycle information?

Click below to explore more details on WIN SOURCE:

 [View CRD4150-15 on WIN SOURCE](#)

 [CR Magnetics Inc. Information](#)

## Optimize Your Supply Chain with WIN SOURCE Solutions

-  Global Sourcing Solution
-  Obsolete Management
-  Cost Control Management
-  Shortage Management
-  Alternative Solution
-  Excess Inventory Management