



**THE DATASHEET OF
1207500000**



Company profile

Weidmüller is the leading manufacturer of components for electrical and electronic interconnection technologies.

The company develops, produces and sells customer-oriented solutions comprising the entire Weidmüller product portfolio. As an OEM supplier, the company sets global standards in the field of electrical connection technology.

The Weidmüller product portfolio ranges from terminal blocks, PCB connectors and terminals, protected components, Industrial Ethernet components and relay sockets to power supply and overvoltage protection modules suitable for all applications. Electrical installation and marking solutions, basic I/O components and a variety of tools round off the range. Weidmüller products are mainly used in control cabinets and for field wiring. Customers also benefit from our wide range of services.

In addition to our expertise in manufacturing precision mechanics, we offer a customer oriented product portfolio for our international customers in the fields of industrial, process and transportation technology. Our developments and activities are driven solely by the individual requirements of our customers in these areas.

The Weidmüller Group has a strong international orientation with production facilities, sales companies and agencies in over 70 countries. Due to our high standards of quality and service, customers around the world value us as a highly competent and flexible partner.

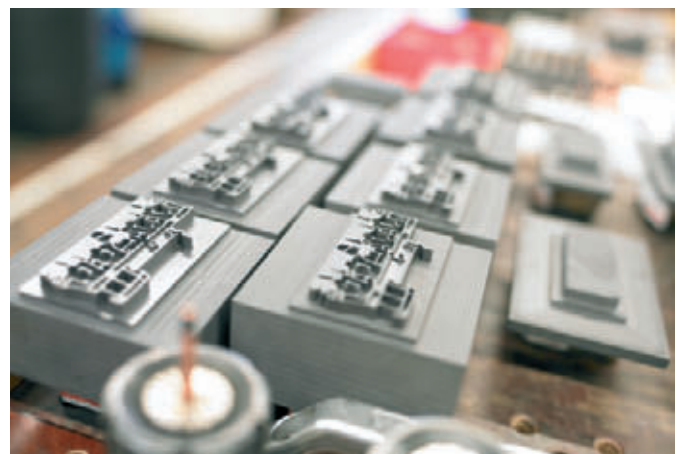

All the catalogues at a glance

Catalogue 1: Modular Terminal Blocks

Order number: 5650110000

- P-Series (Push In technology)
- I-Series (IDC technology)
- Z-Series (Tension clamp technology)
- W-Series (Screw connection technology)
- Stud style (Screw connection technology)

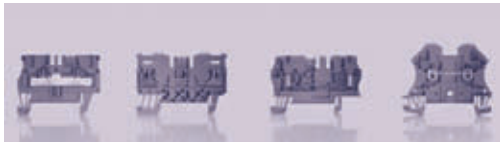

Catalogue 2: PCB Terminals and Connectors

Order number: 5650120000

PCB Terminals with

- leaf spring connection, clamping yoke connection, TOP clamp connection, tension clamp connection, Push In spring connection, spade connection

PCB Connectors of

- Minimate, Omnimate, Unimate, Powermate and Crimpmate Ranges



Catalogue 3: RockStar® – Heavy Duty Connectors

Order number: 5650130000

- Inserts
- Modular system
- Housings IP65 + IP69K



Catalogue 4: Electronics

Order number: 5650140000

- Interface units
- Digital signal processing
- Analogue signal processing
- Power supplies
- Overvoltage protection



Catalogue 5: Enclosures and Cable Glands

Order number: 5650150000

- Enclosures
- Cable gland and Cabtite



Catalogue 6: Tools

Order number: 5650160000

- Cutting
- Stripping
- Crimping
- Screwdrivers
- Measuring/Testing
- Automatic machines



Catalogue 7: Marking Systems

Order number: 5650170000

- Terminal markers
- Wire and cable markers
- Device and equipment markers
- Printing systems
- Software



Catalogue 8: Sensor Actuator Interface

Order number: 5650180000

- SAI Passive
- SAI Active
- Cables and connectors
- JACKPAC® IP67



Catalogue 9: Industrial Ethernet

Order number: 5650190000

- Active components
- Passive components
- Accessories



Complete Set

Order number: 5650100000

- composed of catalogue 1 to catalogue 9 inclusive



Online Catalogue

If you have questions about the specifications and details of our products, perhaps even outside normal business hours, then our online catalogue at <http://catalog.weidmueller.com> – open 24 hours a day, 365 days a year – is the perfect source of information. Besides product features and part numbers, it contains extensive additional information on all product groups. And for further information, offers and your personal contact, simply consult the Weidmüller website at www.weidmueller.com.

CD-ROM

As well as browsing through our printed and online catalogues you can now gain an overview of our products with the help of our CD-ROM. You don't need Internet access nor do you have to install the CD. Simply insert the CD-ROM into the drive and browse away.

The world of connection technology

Control / PLC



**Catalogue 1
Modular Terminal
Blocks**

**Catalogue 3
RockStar® –
Heavy Duty Connectors**

**Catalogue 5
Enclosures and
Cable Glands**

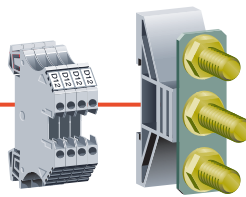

Heavy Duty Connectors

- Inserts
- Modular system
- Housings IP65 + IP69K

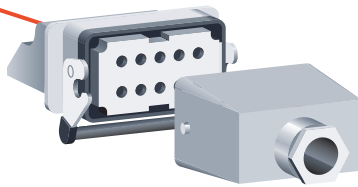

**Enclosures,
Cable glands,
Cabletite**

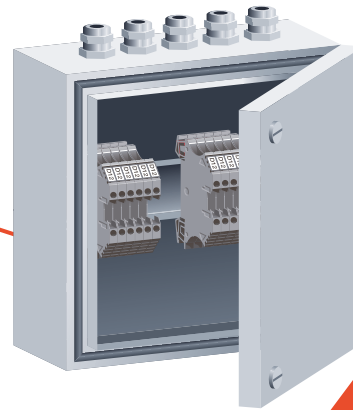

Modular Terminal Blocks

- Push In technology
- IDC technology
- Tension clamp technology
- Screw connection technology

Stud style

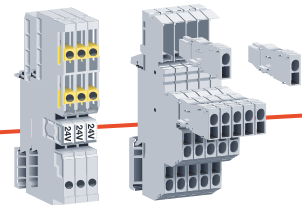

Tools

- Cutting, stripping, crimping, screwdrivers, measuring / testing
- Automatic machines

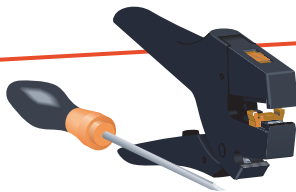

Marking systems

- Terminal-, wire and cable, device and equipment markers
- Printing systems
- Software

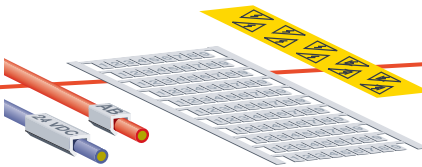

Sensor Actuator Interface

- SAI Passive
- SAI Active
- Cable and connectors
- JACKPAC® IP67

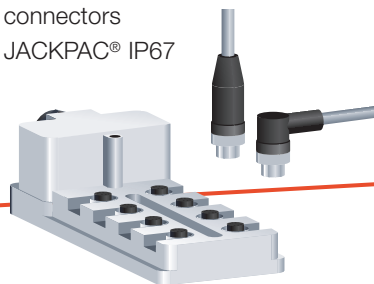

**Catalogue 6
Tools**

**Catalogue 7
Marking Systems**

**Catalogue 8
Sensor Actuator Interface**

Sensors / Actuators

RockStar® – Heavy Duty Connectors

Overview HDC

A

RockStar® inserts

B

RockStar® ConCept modular system

C

RockStar® Housings IP65 / NEMA 4X

D

RockStar® Housing IP69K

E

RockStar® kits

F

RockStar® accessories

G

Cable entries and Cabtite

H

Appendix

Weidmüller Service

V

Index

Search according to Type or order number, Worldwide activities

X

RockStar® – Heavy Duty Connectors

HA series

Page B.4



HA series

Page B.8

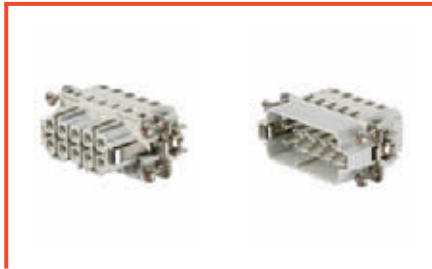

HE series

Page B.18



HEE series

Page B.32



HD series

Page B.42



HD series

Page B.46



HDD series

Page B.66



HVE series

Page B.80

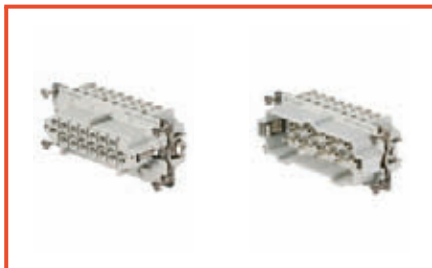

HSB series

Page B.88



MixMate S4

Page B.96



MixMate S4/0

Page B.98



MixMate S6/12

Page B.100



MixMate S6/6

Page B.102



HQ series

Page B.106



CabinetMate DSTV-HE

Page B.112



CabinetMate DSTV-HD

Page B.122



ConCept modular system

Page C.3



ConCept bus modules

Page C.14



RockStar® Housings IP65

Page D.4



RockStar® Housing IP69K

Page E.4



RockStar® kits

Page F.4

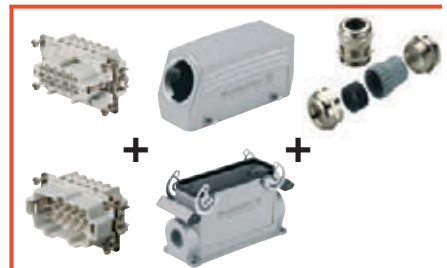

RockStar® accessories

Page G.3



Cable entries

Page H.6



Cabtite

Page H.15



Overview HDC

Aid for selection	Construction of heavy-duty connectors – fixed pole	A.2	
	Overview of size 1 – fixed pole	A.3	
	Overview of sizes 2, 5, 7, 9 – fixed pole	A.4	
	Overview of sizes 3, 4, 6, 8, 10, 12 – fixed pole	A.5	
	Construction of heavy-duty connectors – modular	A.6	
	Overview of sizes 3, 4, 6, 8, 10, 12 – modular	A.7	
	Classes of protection	A.8	
	RockStar® Housing types	A.10	
	Fastening systems	A.11	
	Part codes for inserts and covers	A.12	
	Part codes for housings	A.13	
	Technical data	Connection systems	A.14
		Electrical data	A.16
Chemical resistance		A.20	
Tightening torques and screwing tools		A.21	
Safety information / standards		A.22	

Construction of heavy-duty connectors – fixed pole

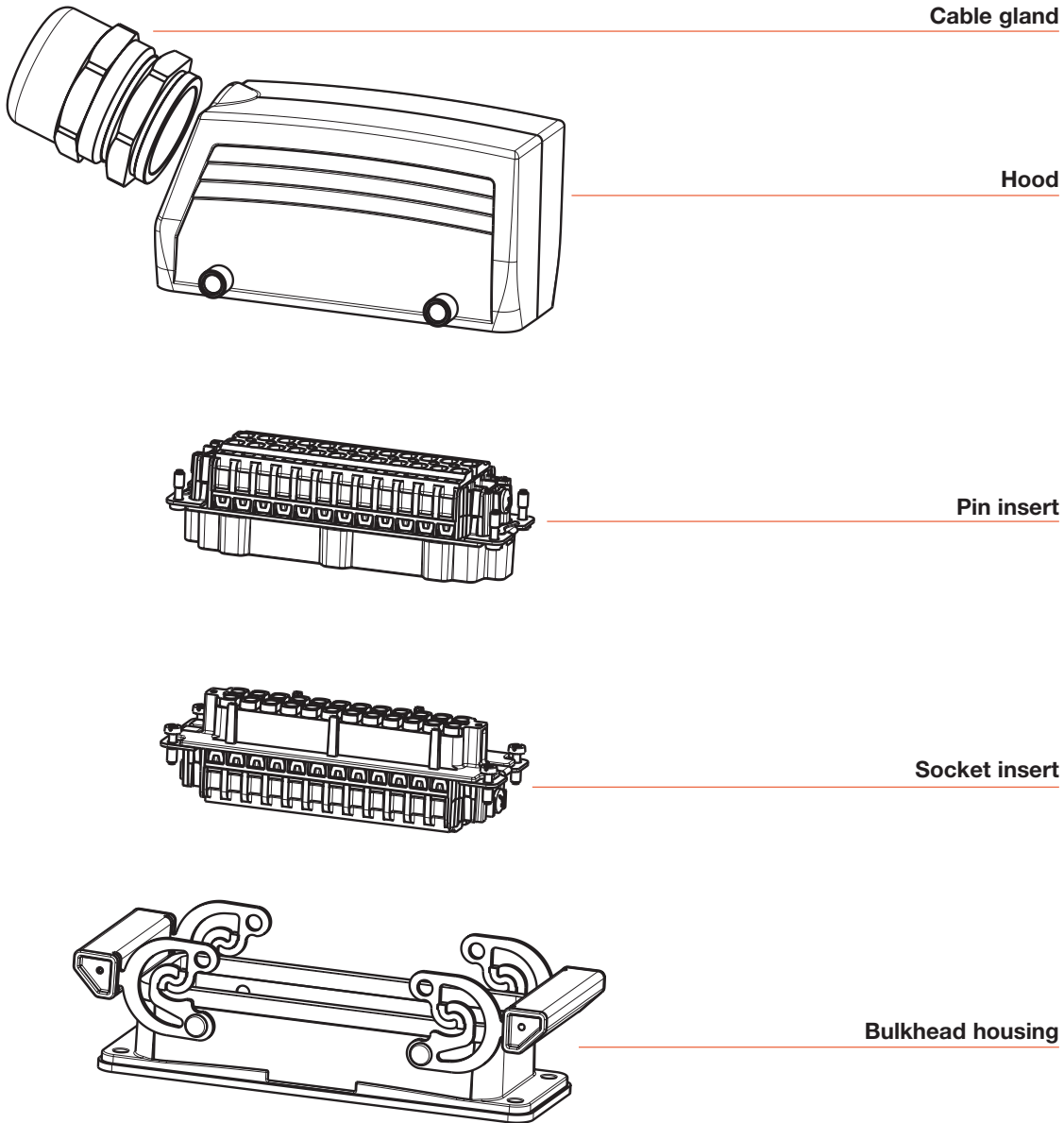

Overview of size 1 – fixed pole

Size

1

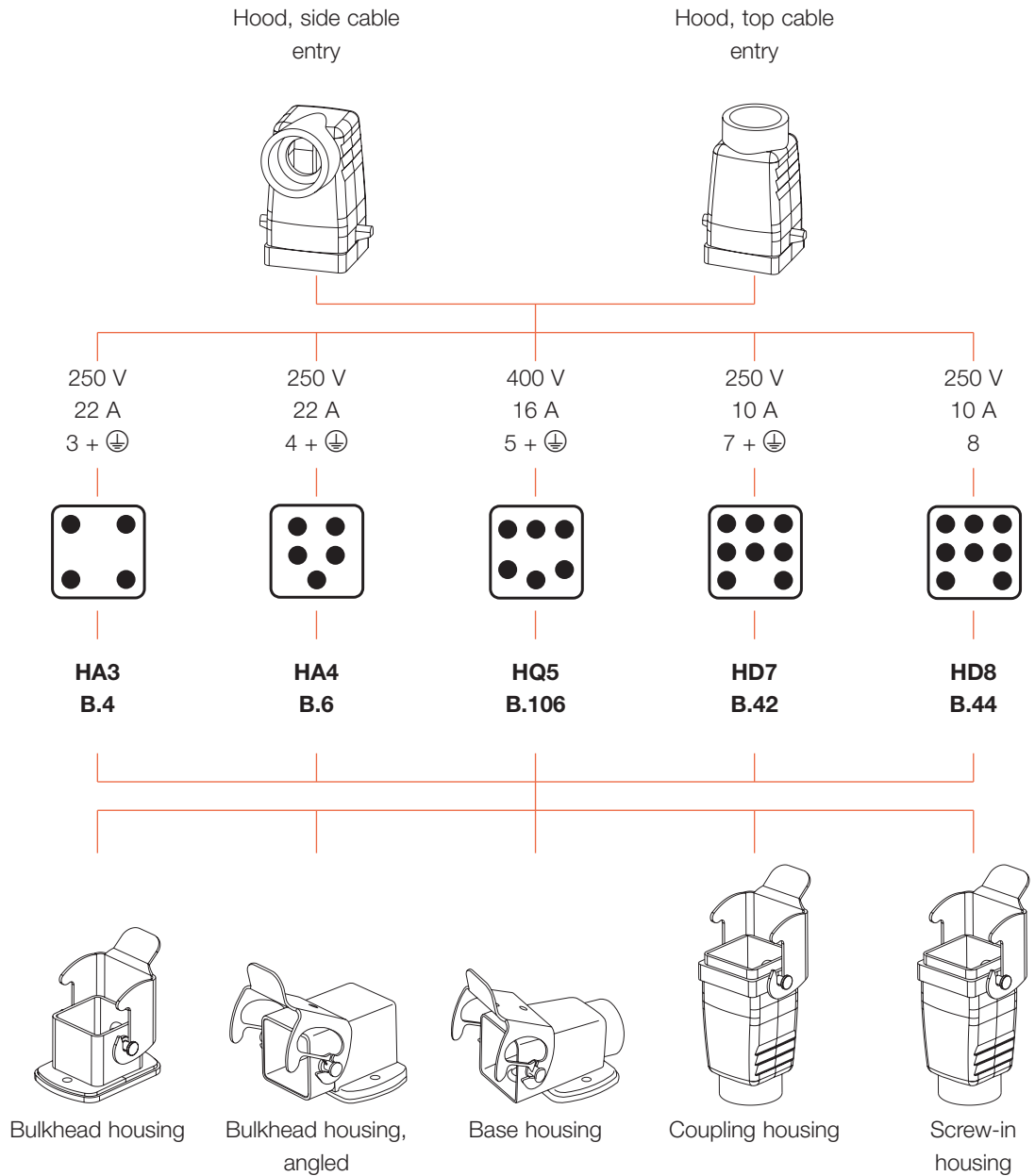

Overview of sizes 2, 5, 7, 9 – fixed pole

Size

2

5

7

9

Hood, side cable entry

Hood, top cable entry

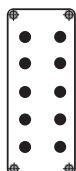
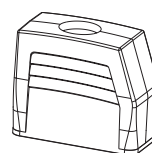

250 V
22 A
10 + ⊕

HA10
B.8

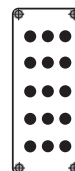

250 V
10 A
15 + ⊕

HD15
B.46



250 V
22 A
16 + ⊕

HA16
B.10



250 V
10 A
25 + ⊕

HD25
B.52

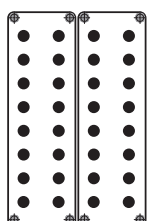

250 V
16 A
32 + ⊕

HA32
B.12

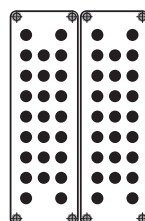

250 V
10 A
50 + ⊕

HD50
B.56

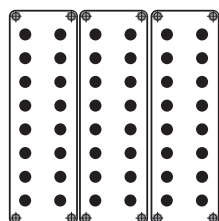

250 V
16 A
48 + ⊕

HA48
B.14

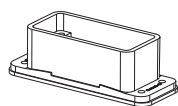

Bulkhead housing

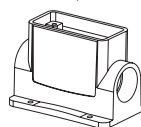

Base housing



Coupling housing

Overview of sizes 3, 4, 6, 8, 10, 12 – fixed pole

Size

Hood, side cable entry

Hood, top cable entry

3



HE6
B.18

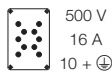

HEE10
B.32

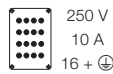

HD16
B.48

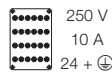

HDD24
B.66

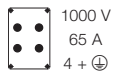

S4
B.96

4

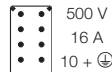

HE10
B.20

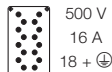

HEE18
B.34

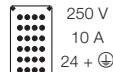

HD24
B.50

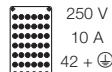

HDD42
B.68

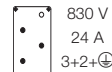

HVE3
B.80

6



HE16
B.22

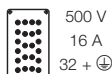

HEE32
B.36

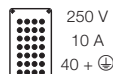

HD40
B.54

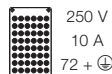

HDD72
B.70

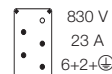

HVE6
B.82

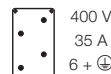

HSB6
B.88

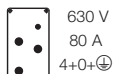

S4/0
B.98

8



HE24
B.24

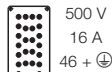

HEE46
B.38

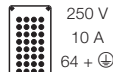

HD64
B.58

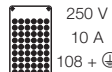

HDD108
B.72

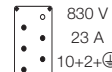

HVE10
B.84

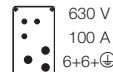

S6/6
B.102



S6/12
B.100

10



HE32
B.26

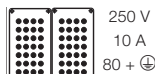

HD80
B.60

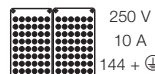

HDD144
B.74

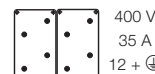

HSB12
B.90

12

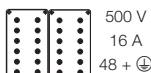

HE48
B.28

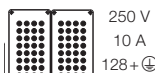

HD128
B.62

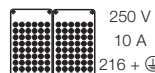

HDD216
B.76

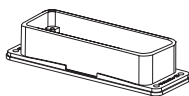

Bulkhead housing

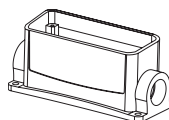

Base housing

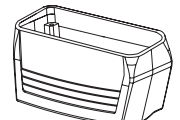

Coupling housing

Construction of heavy-duty connectors – modular

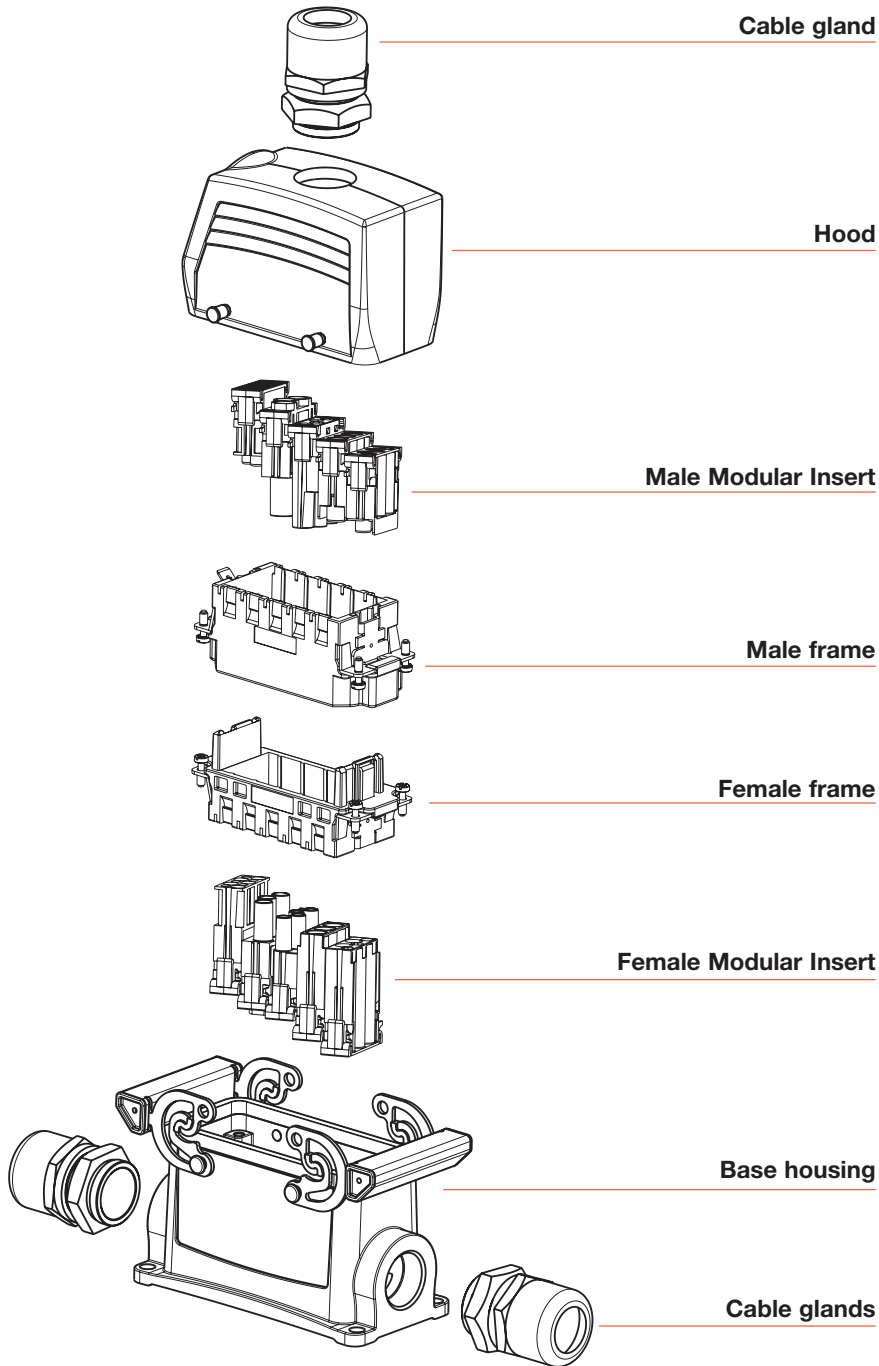

Overview of sizes 3, 4, 6, 8, 10, 12 – modular

Size

Hood, side cable entry

Hood, top cable entry

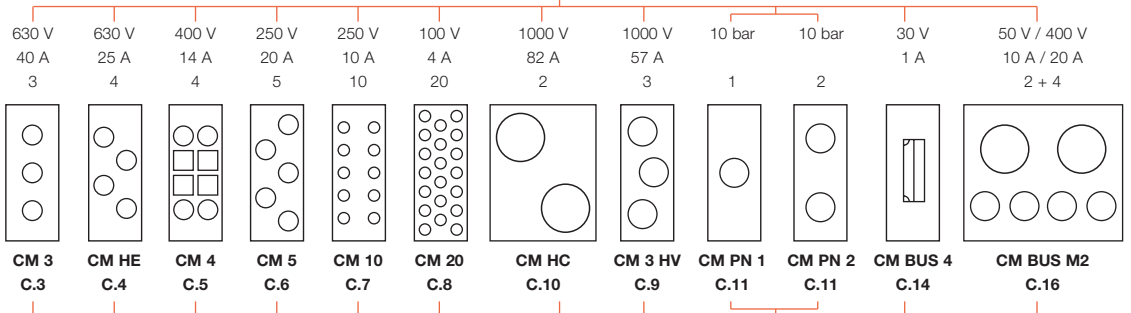

3

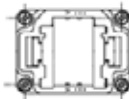

CF6 for 2 modules

4

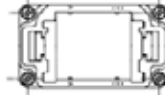

CF10 for 3 modules

6



CF16 for 5 modules

8



CF24 for 7 modules

10

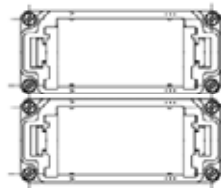

2 x CF16 for 10 modules

12

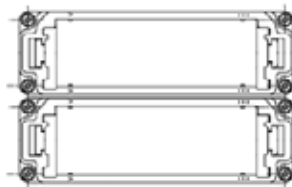

2 x CF24 for 14 modules

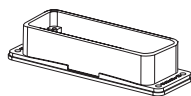

Bulkhead housing

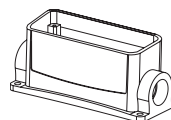

Base housing

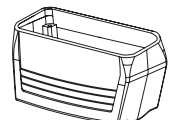

Coupling housing





IP class of protection to DIN EN 60529

A

The class of protection is indicated by a code consisting of the two letters IP and two digits representing the class of protection.

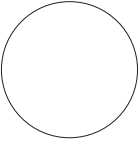
Example: **I P 6 5**
 | |
 2nd digit: protection from liquids
 1st digit: protection from solid bodies

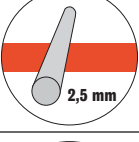
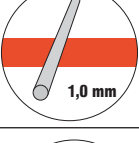
Protection against intrusion of external particle matter (1st digit)

Digit		
0		No protection
1		Protection against ingress of large solid bodies with diameter > 50 mm. (Protection to prevent dangerous parts being touched with the back of the hand.)
2		Protection against ingress of large solid bodies with diameter > 12.5 mm. (Protection to prevent dangerous parts being touched with the fingers.)
3		Protection against ingress of large solid bodies with diameter > 2.5 mm. (Protection to prevent dangerous parts being touched with a tool.)
4		Protection against ingress of large solid bodies with diameter > 1 mm. (Protection to prevent dangerous parts being touched with a piece of wire.)
5		Protection against harmful deposits of dust, which cannot enter in an amount sufficient to interfere with satisfactory operation.
6		Complete protection against ingress of dust.

Protection against penetration of liquids (2nd digit)

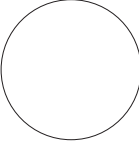
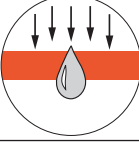
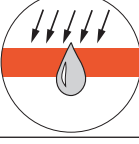
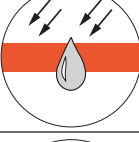
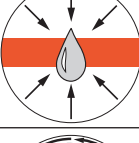
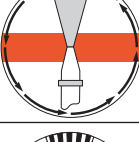
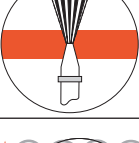
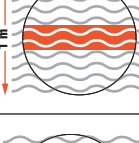
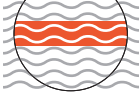
Digit		
0		No protection
1		Protection against drops of condensed water falling vertically.
2		Protection against drops of liquid falling at an angle of 15° with respect to the vertical.
3		Protection against drops of liquid falling at an angle of 60° with respect to the vertical.
4		Protection against liquids splashed from any direction.
5		Protection against water jets projected by a nozzle from any direction.
6		Protection against water from heavy sea on ships' decks.
7		Protection against immersion in water under defined conditions of pressure and time.
8		Protection against indefinite immersion in water under defined conditions of pressure (which must be agreed between manufacturer and user and must be more adverse than number 7).

Class of protection to NEMA

National Electrical Manufacturers Association NEMA 250-1991

Digit	
Type 1	Housing primarily for use in inside rooms. Protects from penetration of solid bodies.
Type 2	Housing primarily for use in inside rooms. Protects from penetration of solid bodies and water.
Type 3	Housing primarily for use in inside rooms. Protects from penetration of rain and snow, dust and damage through ice formation.
Type 3R	Housing primarily for use in inside rooms. Protects from rain and snow as well as damage through ice formation.
Type 3S	Housing primarily for use in inside rooms. Protects from rain, snow and foreign bodies. External mechanisms can be operated despite ice formation.
Type 4	Housing for inside and outside rooms. Protects from rain, foreign bodies, water spray and water jets as well as damage through ice formation on the outside of the housing.
Type 4X	Housing for inside and outside rooms. Protects from corrosion, rain, foreign bodies, water spray and water jets as well as damage through ice formation on the outside of the housing.
Type 6	Housing for inside and outside rooms. Protects from water jets as well as penetration of water when submerged; protects from damage through ice formation on the outside of the housing.

Digit	
Type 12	Housing for use in inside rooms. Protects from dust deposits and non-corrosive dripping liquids.
Type 13	Housing for use in inside rooms. Protects from dust deposits, water spray, oil and non-corrosive coolants.

RockStar® Housing types

Housing IP65 / NEMA 4X



Weidmüller has further developed its IP65 housing. The result is an industrial housing of a new design that also has the properties corrosion resistance and long service life. These new HDC industrial housings even surpass our previous stainless steel housings in all respects. All operation elements are made of stainless steel. A high-quality, multistage surface sealing provides safety for years. Good isn't good enough for us. That's why Weidmüller discontinued the stainless series and why you should use our new IP65 housing.

Applications:

- General mechanical engineering
- Conveying equipment and plant engineering
- Packaging machines
- Lighting and stage equipment
- Fairground rides
- Process engineering
- Transport and traffic engineering

Features:

- Tightness at least IP65 to EN 60529:1991 + A1:2000
- Tightness NEMA 4X
- Scratch-resistant, corrosion-proof, long-lasting

Design:

- Cast aluminium alloy
- 2 versions, standard and high
- Multistage surface coating
- Colour: grey

Fastening systems:

- Clamp lock in different versions of rustproof stainless steel

Housing IP69K – the highest degree of sealing



The IP69K housings have been developed for use under extreme environmental conditions. The high class of protection guarantees trouble-free operation in use on vehicles and under tough climatic conditions. If you want to protect your delicate interfaces from EMC emissions, these connectors are the right choice for you.

Applications:

- Transport and traffic engineering
- Extreme requirements on the class of protection
- Military and communications engineering

Features:

- Tightness IP69K to DIN 40050, part 9 (1993): water sprayed at the housing from any direction under strong pressure must not have any harmful effect.
- Tightness IP68 / 5 bar to EN 60529 (1991) + part A1 (2000)
- Scratch-resistant, corrosion-proof, long-lasting

Design:

- Cast aluminium alloy
- 2 versions, standard and high
- Surrounding metal collar on housing
- Shielded versions for EMC protection
- Robust powder coating of polyester resin
- Colour: black

Fastening systems:

- Screw fastening (see diagram below)

Fastening systems

One longitudinal locking clamp on housing bottom



- Manual operation – no tools required
- 2 locking points – along the longitudinal axis
- Easily accessible with side cable entry
- Particularly suitable for row connection
- Fastening system of rustproof stainless steel

One central locking clamp on housing top



- Manual operation – no tools required
- 2 locking points along the transverse axis
- Easily accessible from above where space is limited
- Easily accessible with side cable entry
- Fastening system of rustproof stainless steel

Two transverse locking clamps on housing bottom



- Manual operation – no tools required
- 4 locking points – good sealing effect
- Easily accessible with cable entry pointing upwards
- Particularly suitable for row connection
- Fastening system of rustproof stainless steel

Screw fastening



- Operation with screwdriver
- Highly effective sealing
- 2 locking points along the longitudinal axis
- Easily accessible from above where space is limited
- Particularly suitable for row connection on all sides
- Stainless steel screws

Part codes for inserts and covers

A

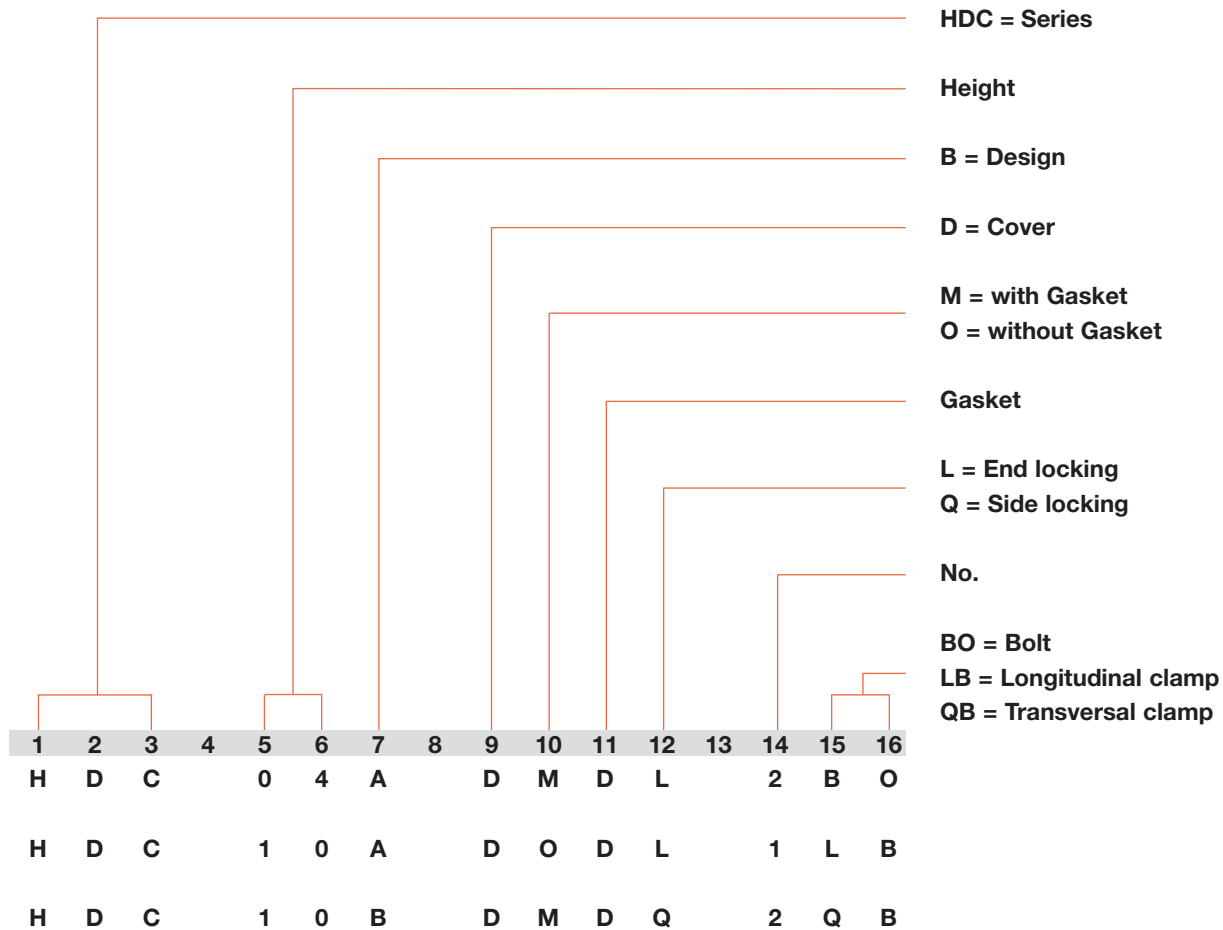
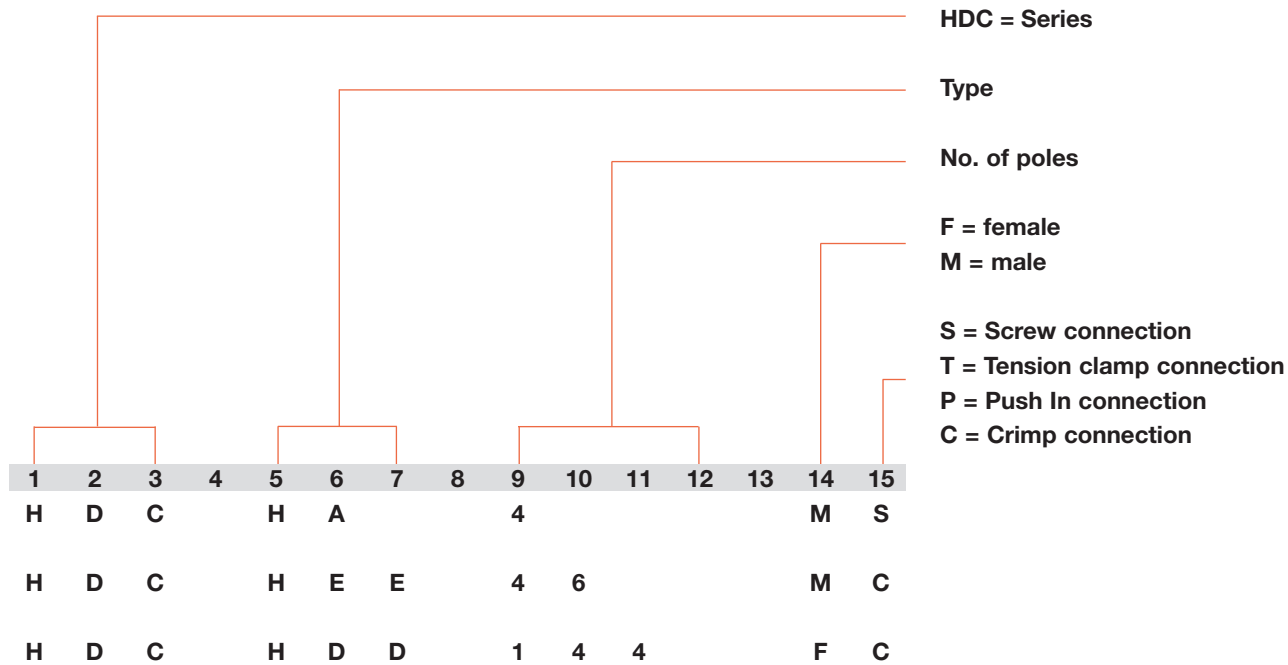

Part codes for housings

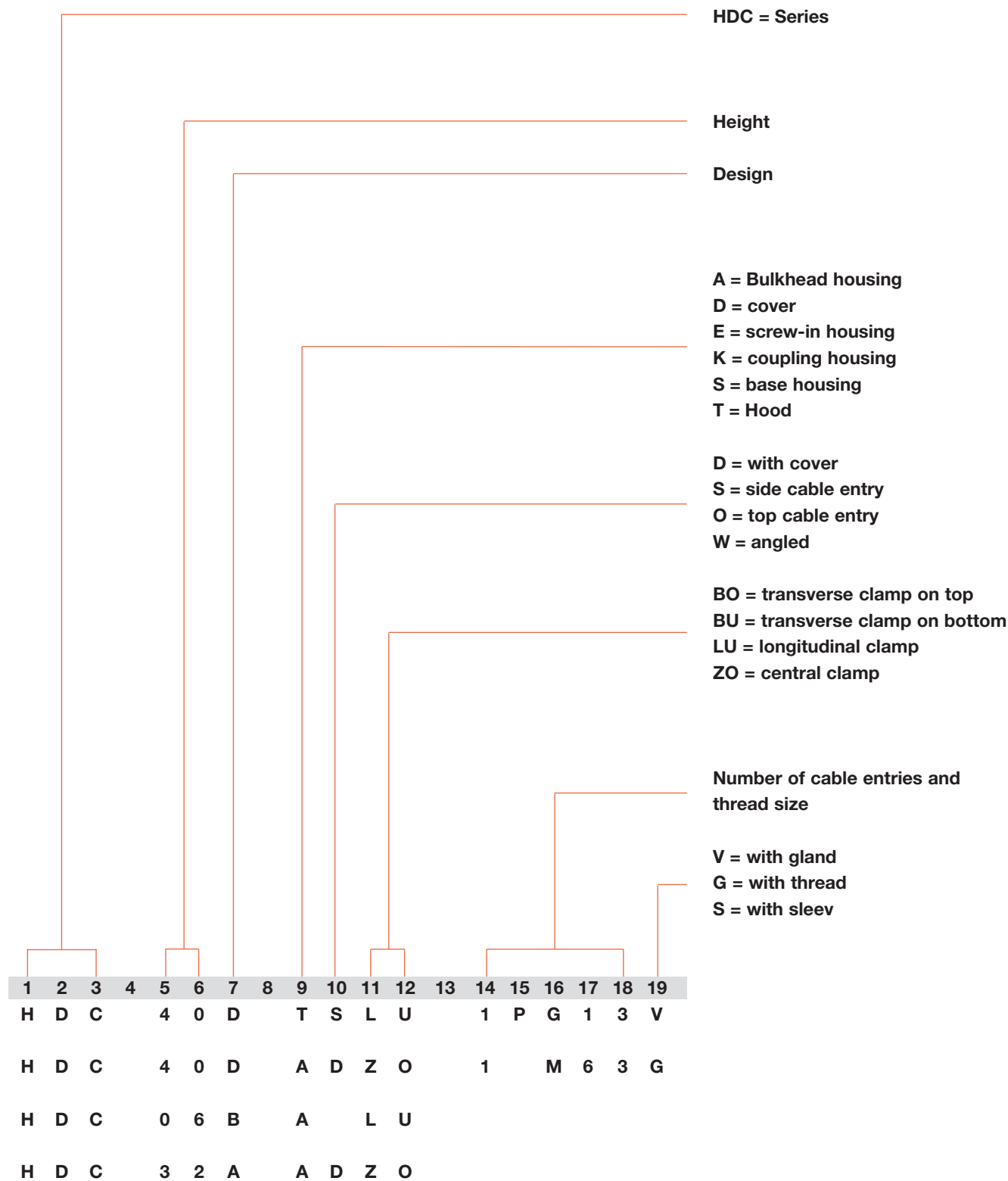

Connection systems

A

Weidmüller offers RockStar connectors with five different connection systems

There are five common types of connection: tension clamp connection, screw connection, crimping, axial screw connection and push-in technology.

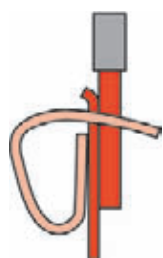

Tension clamp connection

The **Weidmüller tension clamp system** functions similarly to the tried-and-tested clamping yoke. Here again, the mechanical and electrical functions are kept separate. The tension spring made from high-quality rustproof and acid-proof steel pulls

the conductor against the tin-plated copper current bar.

Treating the copper in this way ensures low contact resistance and high corrosion resistance. The compensating effect of the tension spring ensures a secure contact for the lifetime of the terminal.

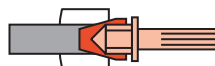

The advantage of the axial screw connection

is the small space taken up by the contact. This increases creepage distances and improves

current transfer. The axial screw connection is also extremely easy to use. To make up the connection, the tool and conductor are held in a line. Just three steps are needed for a secure connection: strip the conductor, insert the wire into the contact chamber, screw in the contact – that's all!

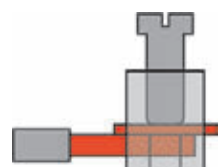

Clamp body with female thread in the Weidmüller screw terminal system consist of non-ferrous CuZn material. They are protected against corrosion with a passivated silver or gold surface with wire guard of stainless

steel against impermissible deformation of solid conductors and splaying of flexible leads as well as nicking by the clamping screw. With this clamping system, a gas-tight, vibration-proof connection between conductor and clamping yoke is established. This clamping system has proven itself millions of times over in Weidmüller products.



Push In system

In the **Push In system** the stripped solid conductor is simply inserted into the clamping point as far as it will go. And that completes the connection! No tool is required and the result is a reliable, vibration-

resistant and gas-tight connection. Even flexible conductors with crimped wire end ferrules or ultrasonic-welded conductors can be connected without any problems. A stainless steel compression spring, which is fitted in a separate housing, guarantees a high contact force between the conductor and the current bar (tin-plates copper). The pull-out force for this system is even higher than that for the tension clamp system. Spring and conductor stops in a steel housing ensure optimum connection conditions and a guide for the screwdriver needed to detach the conductor.



In the **crimping** method, the wires are fed into a metal sleeve, which is then squeezed together with a special

tool. The connection is now corrosion and vibration proof. The contacts can be attached to the conductor away from the connector and then inserted into it.

Crimp contacts

Whereas the contacts for screw, axial screw, tension clamp and Push In connections are already built in, the customer can choose the appropriate contact for a crimp connection.



The contacts are the heart of a plug-in connector. They represent the actual connection between two conductors. Two kinds of contact are necessary: pins and sockets (male and female). The pin conducts the electrical current on its outer surface and is introduced into the socket, which conducts the electrical current on its inner surface. Heavy-duty connectors have copper alloy contacts and the contact surfaces are plated with gold or silver: silver improves conductivity, gold is corrosion-proof. Crimp contacts are available in turned, solid form.

Selection of silver or gold-plated contacts

When using plug-in connectors under standard conditions, the resistance between the contacts has little effect. Even heavily corroded silver-coated contact pins and sockets rarely show contact problems.

The situation is different where there are very small currents in extreme applications such as those in electroplating shops, tunnels or in cellulose processing. The silver oxide layer on the surface of the contacts forms an electrical resistance with capacitive, inductive and ohmic components. As a result, the original signal is distorted so much that the recipient is unable to detect it properly and interprets it incorrectly. This results in faults and, indirectly, to damage to machines and processes. Gold-plated contacts should be used in such cases.

The rule of thumb is: use gold-coated contacts for currents < 5 mA and voltages of up to 5 V.

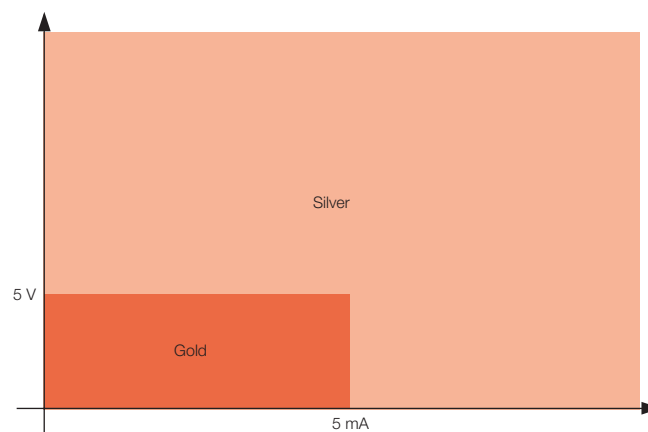

Electrical data

A

Design of clearances and creepage distances in electrical equipment

General

Since April 1997 the sizing of clearances and creepage distances has been covered by DIN VDE 0110, part 1 "Insulation coordination for electrical equipment in low-voltage systems". DIN VDE 0110, part 1 contains the modified edition of IEC Report 664-1 (see also IEC 664-1/Oct 1992). Since April 2003, the rules of DIN EN 60664-1 / 11.03 in conjunction with DIN 61984 / 09.02 apply to the dimensioning of clearances and creepage distances.

The design data resulting from these provisions is – if applicable – specified in this catalogue for each product.

For the design of clearances and creepage distances, application of the regulations for insulation coordination produces the following interrelationships:

Clearances

Clearances are rated in accordance with the following factors:

- Anticipated overvoltage
rated impulse withstand voltage
- Used
overvoltage protection precaution
- Measures to prevent pollution
pollution severity

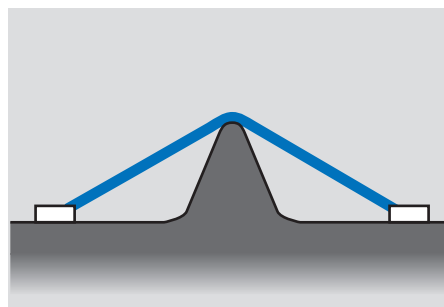

Creepage distances

Creepage distances are rated in accordance with the following factors:

- Planned
rated voltage
- Insulation materials used
insulation group
- Measures to prevent pollution
pollution severity

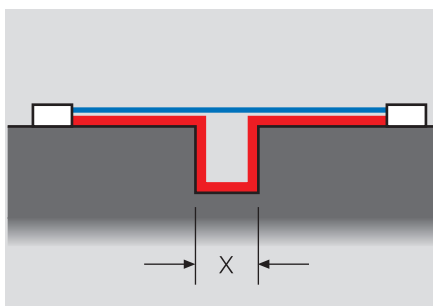
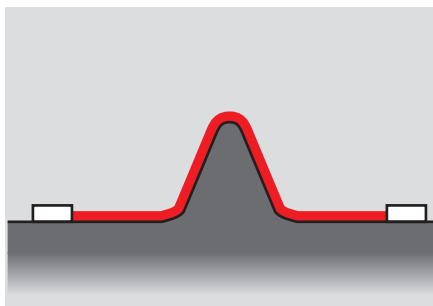

Slots are taken into account when measuring creepage distances if their minimum width X is dimensioned according to the following table:

Pollution severity	Minimum width X in mm
1	0.25
2	1.0
3	1.5
4	2.5

If the associated clearance in air is less than 3 mm, the minimum slot width can be reduced to 1/3 of the clearance.

Influencing factors:

Rated impulse withstand voltage

The rated impulse withstand voltage is derived from:

- **Phase-to-earth voltage** (the nominal voltage of the network, taking all networks into account)
- **Overvoltage category**

The overvoltage categories are defined

in accordance with international standard DIN EN 60664-1 (for electrical equipment fed directly from the low voltage network).

Overvoltage category I

- Equipment that is intended to be connected to the permanent electrical installation of a building. Measures to limit transient overvoltages to the specific level are taken outside the equipment, either in the permanent installation or between the permanent installation and the equipment.

Overvoltage category II

- equipment to be connected to the permanent electrical installation of a building e.g. household appliances, portable tools and similar loads.

Overvoltage category III

- equipment that is part of the permanent electrical installation and other equipment where a higher degree of availability is expected e.g. distribution boards, circuit-breakers, wiring systems (IEV 826-06-01, including cables, busbars, junction boxes, switches, power sockets) in the permanent installation, and equipment for industrial use and some other equipment, e.g. stationary motors with permanent connections to the permanent installation.

Overvoltage category IV

- Equipment for use at or in the proximity of the incoming supply point of the electrical installations of buildings upstream of the main distribution board e.g. electricity meters, circuit-breakers and ripple control units.

Pollution severity categories:

Pollution severity category 1

- No pollution, or only dry, non-conductive pollution that has no influence.

Pollution severity category 2

- Non-conductive pollution only; occasional condensation may cause temporary conductivity.

Pollution severity category 3

- Conductive pollution, or dry, non-conductive pollution that is liable to be rendered conductive through condensation.

Pollution severity category 4

- Contamination results in constant conductivity, e.g. caused by conductive dust, rain or snow.

The dimensioning of clearances and creepage distances, and hence the rating data for electromechanical products (terminals, terminal strips, PCB terminals and plug-in connectors) is based on pollution severity 3 and overvoltage category III, taking account of all network types.

Table 1: Three-phase 4 or 3-conductor a.c. systems

Nominal voltage of power supply systems [V]	for conductor-cond. insulat.	for conductor-earth insulation	
	all Systems [V]	3-phase 4-conductor systems with earthed neutral cond. [V]	3-phase 4-conductor systems unearthed or cond. earthed [V]
60	63	32	63
110			
120	125	80	125
127			
150	160	–	160
208	200	125	200
220			
230	250	160	250
240			
300	320	–	320
380			
400	400	250	400
415			
440	500	250	500
480			
500	500	320	500
575	630	400	630
600	630	–	630
660			
690	630	400	630
720			
830	800	500	800
960	1000	630	1000
1000	1000	–	1000

Electrical data

A

Design of clearances and creepage distances in electrical equipment, influencing factors:

Rated voltage

The rated voltage is derived from the nominal voltage of the power supply and the corresponding network type.

Single-phase

2- or 3-wire AC or DC systems

Rated voltage of the power supply (mains) ¹⁾	Voltages for table 4	
	For insulation phase-to-phase ¹⁾	For insulation phase-to-earth ¹⁾
	All systems	3-wire systems, neutr. point earthing
V	V	V
12.5	12.5	–
24 / 25 30	25 32	–
42 / 48 / 50 ^{*)} 60	50 63	–
30-60	63	32
100 ^{*)}	100	–
110 / 120 150 ^{*)}	125 160	–
220	250	–
110-220 120-240	250	125
300 ^{*)}	320	–
220-440	500	250
600 ^{*)}	630	–
480-960	1000	500
1000 ^{*)}	1000	–

3-phase

3- or 4-wire AC systems

Rated voltage of the power supply (mains) ¹⁾	Voltages for table 4		
	For insulation phase-to-phase	For insulation phase-to-earth	
	All systems	3-phase 4-wire systems with earthed neutral wire ²⁾	3-phase 3-wire systems unearthed ¹⁾ or phase-earthed
V	V	V	V
60	63	32	63
110/120/127	125	80	125
150 ^{*)}	160	–	160
208	200	125	200
220/230/240	250	160	250
300 ^{*)}	320	–	320
380/400/415	400	250	400
440	500	250	500
480/500	500	320	500
575	630	400	630
600 ^{*)}	630	–	630
660/690	630	400	630
720/830	800	500	800
960	1000	630	1000
1000 ^{*)}	1000	–	1000

1) Phase-to-earth insulation levels for unearthed or impedance-earthed systems are equal to those of phase-to-phase because the operating voltage to earth of any phase can, in practice, reach full phase-to-phase voltage. This is because the actual voltage to earth is determined by the insulation resistance and capacitive reactance of each phase to earth; thus, a low (but acceptable) insulation resistance of one phase can earth it and raise the other two to full phase-to-phase voltage to earth.

2) For electrical equipment for use in both 3-phase 4-wire and 3-phase 3-wire supplies, earthed and unearthed, use the values for 3-wire systems only.

*) It is assumed that the rated voltage of the electrical equipment is not lower than the nominal voltage of the power supply.

**) Because of the common changes, the meaning of the ** symbol has not been used in table 1; i.e. the / symbol indicates a 4-wire 3-phase distribution system. The lower value is the phase-to-neutral voltage, while the higher value is the phase-to-phase voltage. Where only one value is indicated, it refers to 3-wire 3-phase systems and specifies the value phase-to-phase. The values given in table 1 are still taken into account in tables 3a and 3b by the ** symbol.

Insulating material

The insulating materials are subdivided into four groups according to their CTI (Comparative Tracking Index):

Insulating material

I	600 ≤ CTI
II	400 ≤ CTI < 600
III a	175 ≤ CTI < 400
III b	100 ≤ CTI < 175

The comparative tracking index must be determined according to DIN IEC 112/VDE 0303 part 1 on the basis of specially prepared samples with test solution A.

The **derating curve** shows which currents may flow continuously and simultaneously via all possible connections when the component is subjected to various ambient temperatures below its upper limit temperature.

The **upper limit temperature** of a component is the rated value determined by the materials used. The total of the ambient temperature plus the temperature rise caused by the current load (power loss at contact resistance) may not exceed the upper limit temperature of the component, otherwise it will be damaged or even completely ruined. The current-carrying capacity is hence not a constant value, but rather decreases as the component ambient temperature increases. Furthermore, the current-carrying capacity is influenced by the geometry of the component, the number of poles and the conductor(s) connected to it.

The current-carrying capacity is determined empirically according to DIN IEC 60512-3. To do this, the resulting component temperatures t_{b1} , t_{b2} ... and the ambient temperatures t_{u1} , t_{u2} are measured for three different currents I_1 , I_2 , I_3 The values are entered on a graph with a system of linear coordinates to illustrate the relationships between the currents, the ambient temperatures and the temperature rise in the component.

The **loading currents** are plotted on the y-axis, the **component ambient temperatures** on the x-axis. A line drawn perpendicular to the x-axis at the upper limit temperature t_g of the component completes the system of coordinates. The associated average values of the temperature rise in the component, $\Delta t_1 = t_{b1} - t_{u1}$, $\Delta t_2 = t_{b2} - t_{u2}$, ... are plotted for every current I_1 , I_2 , ... to the left of the perpendicular line. The points generated in this way are joined to form a roughly parabolic curve.

As it is practically impossible to choose components with the maximum permissible contact resistances for the measurements, the base curve must be reduced. Reducing the currents to 80% results in the **“derating curve”** in which the maximum permissible contact resistances and the measuring uncertainties in the temperature measurements are taken into account in such a way that they are suitable for practical applications, as experience has shown. If the derating curve exceeds the currents in the low ambient temperature zone, which is given by the current-carrying capacity of the conductor cross-sections to be connected, then the derating curve should be limited to the smaller current in this zone.

Base curve

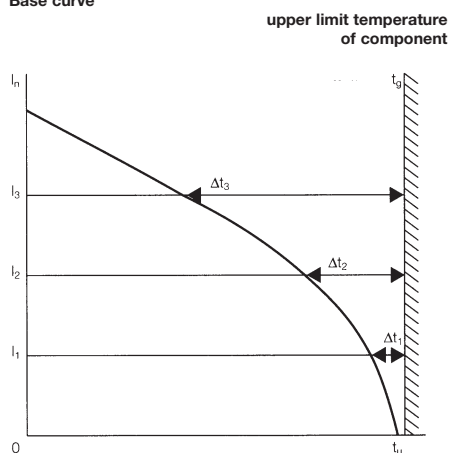

t_g = upper limit temperature of component
 t_u = ambient temperature
 I_n = current

Derating curve

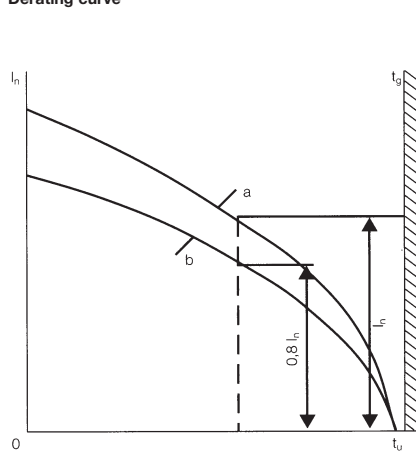

t_g = upper limit temperature of component
 t_u = ambient temperature
 I_n = current
 a = Base curve
 b = Reduced base curve (derating curve)

Chemical resistance

Chemical resistance of inserts (material PC, 20 % GF)

Acetone	+
Ammonia, aqueous	-
Petrol	+
Benzine	+
Diesel oil	-
Acetic acid, concentrated	+
Aqueous potassium hydroxide	-
Methanol	-
Engine oil	-
Alkaline solution, diluted	+
Chlorinated hydrocarbons	-
Use in open air	-

Chemical resistance of standard housing seal (material NBR)

Acetone	-
Drilling oil	+
Diesel	+
Ethyl alcohol	+
Gear oil	+
Hydraulic oil	+
Cooling lubricant	+
Petrol	+
Sweat	+
High-octane petrol	-
Water	+

+ resistant

- partially resistant

o not resistant

Tightening torques and screwing tool

Screw size	Connector type	Dia. tightening torque in Nm	Recommended blade inserts and AF size for hexagon socket
M 2.5	S 6/6 and S 6/12 Clamping point		
	Signal contact	0.5 – 0.55	0.6 x 3.5 mm ± Gr. PZ0
M 3	Screw insert HA 3; HA 4; HQ 5	0.5 – 0.55	0.6 x 3.5 mm ± Gr. PZ0
M 3	Screw insert HA 10 - HA 48	0.5 – 0.55	0.6 x 3.5 mm ± Gr. PZ0
M 3	Screw insert HE series HVE series		
	Fastening screws	0.5 – 0.55	0.6 x 3.5 mm ± Gr. PZ0
	Guide pin	0.5 – 0.55	0.6 x 3.5 mm ± Gr. PZ0
	Guide bush	0.5 – 0.55	0.6 x 3.5 mm ± Gr. PZ0
	Coding pins	0.4 - 0.5	0.6 x 3.5 mm ± Gr. PZ0
M 4	PE terminal HA series	1.2 - 1.5	0.6 x 3.5 or 0.8 x 4 mm ± Gr PZ1
	HE series	1.2 - 1.5	0.6 x 3.5 or 0.8 x 4 mm ± Gr PZ1
	HVE series	1.2 - 1.5	0.6 x 3.5 or 0.8 x 4 mm ± Gr PZ1
	HD series	1.2 - 1.5	0.6 x 3.5 or 0.8 x 4 mm ± Gr PZ1
	HDD series	1.2 - 1.5	0.6 x 3.5 or 0.8 x 4 mm ± Gr PZ1
M 4	Screw insert HSB series	1.2 - 1.5	0.6 x 3.5 or 0.8 x 4 mm ± Gr PZ1
M 5	PE terminal HSB series	2 - 2.5	1 x 5.5 mm ± Gr. PZ2
M 7 x 0.75 S 4	Axial connection of power contacts	1.1 – 1.7	SW 2
M 4	S 4 PE screw via male contact	1.2 – 1.5	SD 0.6 x 3.5 mm
M 3	S 4 PE Schraub via female contact	0.5 – 0.55	SD 0.6 x 3.5 mm
M 7 x 0.75	S 6/6 Axial connection of power contacts	6 – 8	SW 4
M 8 x 0.75	S 6/12 Axial connection of power contacts	1.1 – 1.7	SW 2
M 10 x 1	S 4/0 Axial connection of power contacts	2 – 3	SW 3

Increasing the tightening torque does not improve the contact resistance. The stated torque settings offer optimal mechanical, thermal and electrical conditions. Exceeding the recommended values may even damage the conductor and terminal.

Safety information / standards

A**Pay attention to the following safety advice:**

- Never plug or unplug connectors under load or in operation.
- We can only guarantee the technical and electro-technical characteristics promised in this catalogue if all the components were supplied by Weidmüller.
- Not needed clamping points must be closed.

The following standards apply in the vicinity of heady-duty connectors:

- DIN EN 60664-1 or IEC 60664-1:
Insulation coordination for equipment within low-voltage systems; principles, requirements and tests (replaces DIN VDE 0110-1)
- DIN EN 61984 or IEC 61984:
Plug-in connectors – safety requirements and tests
- DIN EN 175301-801:
Detail Specification: High-density rectangular plug-in connectors, round removable crimp contacts; (replaces DIN 43652)
- DIN EN 60352 or IEC 60352:
Solderless connections
- DIN EN 60529 or IEC 60529:
Classes of protection provided by enclosures (IP code)
- DIN VDE 0870:
Electromagnetic influence
- DIN EN 60999-1:
Connecting devices, safety requirements for screw terminal connections and screwless terminal connections for electrical copper conductors ...
- DIN 40050-9:
Road vehicles; classes of protection (IP-code); ...
- DIN EN 60664-1:
Plug-in connectors – safety requirements and tests

RockStar® inserts

RockStar® inserts	
HA series – the slim connectors	B.2
250 V	
22 A	
3 – 48 poles	
HE series – the universal connectors	B.16
500 V	
24 A	
6 – 48 poles	
HEE series – high contact density	B.30
500 V	
16 A	
10 – 46 poles	
HD series – the flexible connectors	B.40
250 V	
10 A	
7 – 128 poles	
HDD series – the compact connectors	B.64
250 V	
10 A	
24 – 216 poles	
HVE series – exciting voltage	B.78
830 V	
23 A	
3 + 2; 6 + 2; 10 + 2 poles	
HSB series – the heavy-duty connectors	B.86
400 V	
35 A	
6 – 12 poles	
MixMate series – the high-capacity connectors	B.92
1000 V / 630 V	
100 A	
4; 4/0; 6/6 and 6/12 poles	
HQ series – the powerful little connectors	B.104
400 V	
16 A	
5 – 8 poles	
CabinetMate DSTV-HE series – connector at front, terminal at rear	B.110
500 V	
16 A	
6 – 24 poles	
CabinetMate DSTV-HD series – connector at front, terminal at rear	B.120
250 V	
10 A	
16 – 64 poles	

HA series – the slim connectors

When space is tight, the small and narrow HA series comes into its own.

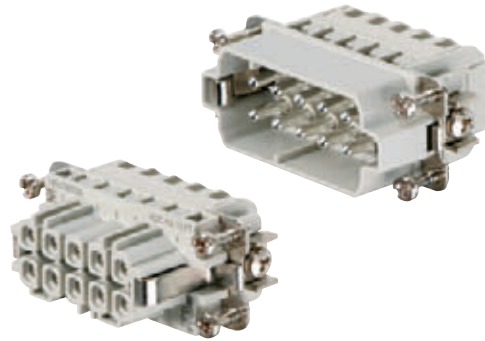







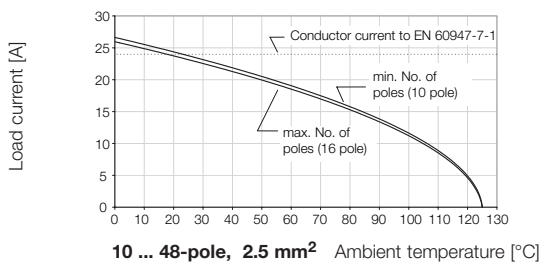
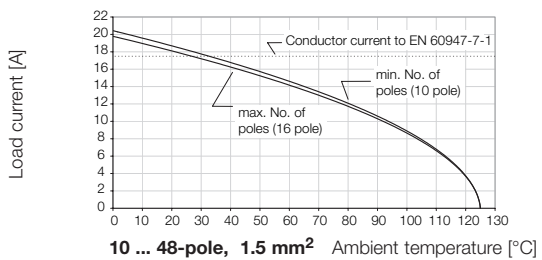
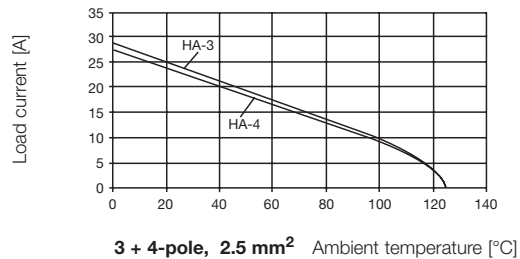
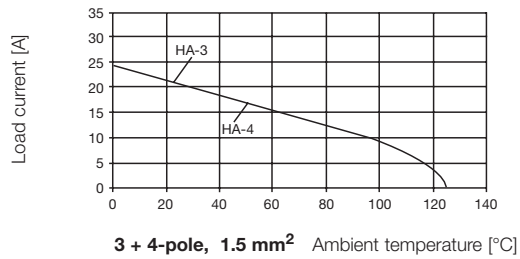





Technical data

Standards / approvals	
Standards	DIN EN 61984 DIN EN 60664-1
Approvals	UL/CSA
Inserts	
No. of poles	3, 4, 10, 16, 24, 32, 48
Rated voltage	250 V
Rated voltage to UL/CSA	600 V
Rated current	22 A (≥ 24 Poles 16 A)
Rated impulse withstand voltage	4 KV
Pollution severity	3
Insulation resistance	≥ 10 ¹⁰ Ω
Material	Glass-fibre reinforced PC (in UL list and approved for railway applications)
Temperature range	-40 °C ... +125 °C
Flammability to UL 94	V - 0
Mechanical service life	
- Plugging cycles Ag - Surface	≥ 500
- Plugging cycles Au - Surface	≥ 500
Contact resistance	
- Crimp connection	≤ 4 mΩ
- Screw tension clamp	≤ 2 mΩ
Contacts / Material	
Sockets and plug-in contact	Copper alloy
Surface	Passivated silver, or 0.8 μm gold on 2 μm nickel
Clamping unit / Screw connection	
Clamping range / Stripping length	
- Crimp connection*	0.5 - 4 mm ² (AWG 20 ... 12) / 8 mm
- Screw connection	0.5 - 2.5 mm ² (AWG 20 ... 14) / 9 mm
- Tension clamp connection	0.5 - 2.5 mm ² (AWG 20 ... 14) / 8 mm
* The crimp is with flexible conductors.	
Clamping torque	
- Screw connection	0.5 - 0.55 Nm
SD blades	
- Screw connection	0.6 x 3.5 or PZ 0
- Push In	0.4 x 2.5
- Tension clamp connection	0.5 x 3 or 0.6 x 3.5
PE connection	
- Clamping range	0.5 ... 4 mm ²
- solid / stranded	0.5 ... 4 mm ² / 0.5 ... 4 mm ²
- flexible / flexible with wire end ferrule, DIN 46228 pt. 1	0.5 ... 4 mm ² / 0.5 ... 4 mm ²
- AWG conductor	AWG 20 ... 12
- Stripping length	10 mm
- Clamping torque	1.2 ... 1.5 Nm
- Blade dimensions	SD 0.8 x 4 mm or PZ 1
Note: HA 3 and HA 4: PE terminal max. 2.5 mm ² via socket and pin. Thread M3, torque range 0.5-0.55 Nm; * Crimp connection 2.5 mm ² = 24 A - 4 mm ² = 29 A; Switch off power supply before handling plug-in connectors.	

Derating curves



Overview

		Rated voltage	Rated current	No. of poles	Tension clamp connection	Screw conn. with wire guard spring	Crimp connection	Push In	Axial screw connection	Page
		250 V	22 A	3 + ⊕		•				B.4
		250 V	22 A	4 + ⊕		•				B.6
		250 V	22 A	10 + ⊕	•	•	•			B.8
		250 V	22 A	16 + ⊕	•	•	•			B.10
		250 V	16 A	32 + ⊕	•	•	•			B.12
		250 V	16 A	48 + ⊕	•	•	•			B.14

HA series - the slim connectors

250 V, 22 A, Size 1

3 + ⊕

Inserts



Screw connection



Insert	Designation	Order No.
Male	HDC HA 3 MS	1498100000
Female	HDC HA 3 FS	1498200000

Dimensions

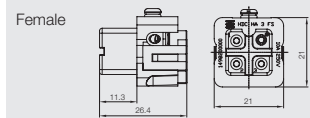
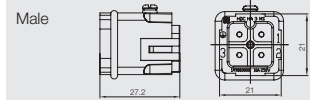

Arrangement of contacts



**Selection of Housings RockStar® IP65
Size 1**



Hood

material: Diecast aluminium

Hood, Cable Entry sideways



a	Version	Cover	b (mm)	Designation	Order No.
M 20	with thread		49,2	HDC 04A TWLU 1M20G	1788810000

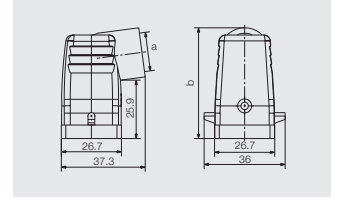

Hood, Cable Entry at top



a	Version	Cover	b (mm)	Designation	Order No.
M 20	with thread		50	HDC 04A TOLU 1M20G	1788820000

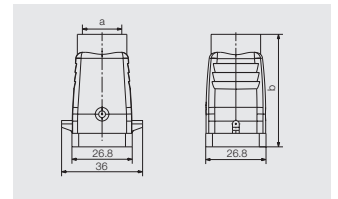

Base

Bulkhead housing



Version	Cover	b (mm)	Designation	Order No.
		23	HDC 04A ALU	1497600000

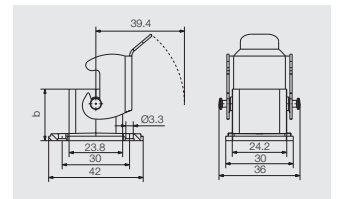

Base housing



a	Version	Cover	b (mm)	Designation	Order No.
M 20	with thread		25,8	HDC 04A SLU 1M20G	1788830000

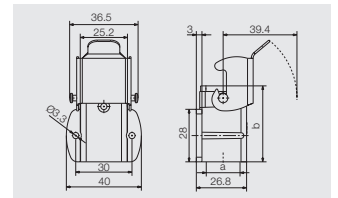

Coupling hood



a	Version	Cover	b (mm)	Designation	Order No.
M 20	with thread		53,5	HDC 04A KOLU 1M20G	1788840000

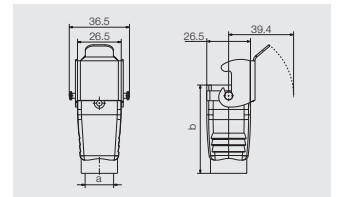

Screw Mounting Housing



a	Version	Cover	b (mm)	Designation	Order No.
M 20	with thread		54	HDC 04A ELU 1M20G	1900320000
PG 13,5	with thread		54	HDC 04A ELU 1PG13G	1900330000
PG 13,5	with thread		54	HDC 04A ELU 1PG13G EXI	1900350000

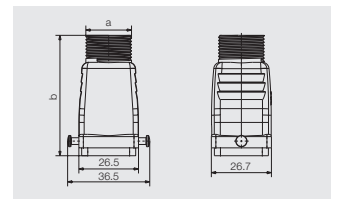

Cover



Version	Designation	Order No.
for female insert	HDC 04A DMDL 2BO	1665750000
for male insert	HDC 04A DODL 2BO	1665740000

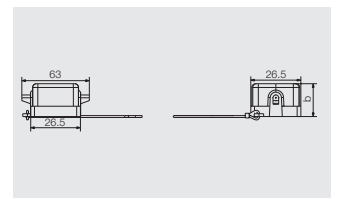

HA series - the slim connectors

250 V, 22 A, Size 1

4 + ⊕

Inserts



Screw connection



Insert	Designation	Order No.
Male	HDC HA 4 MS	1498300000
Female	HDC HA 4 FS	1498400000

Dimensions

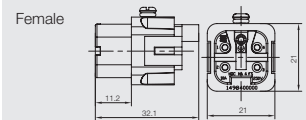
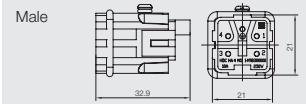

Arrangement of contacts



**Selection of Housings RockStar® IP65
Size 1**



Hood

material: Diecast aluminium

Hood, Cable Entry sideways



a	Version	Cover	b (mm)	Designation	Order No.
M 20	with thread		49,2	HDC 04A TWLU 1M20G	1788810000

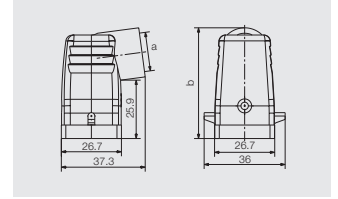

Hood, Cable Entry at top



a	Version	Cover	b (mm)	Designation	Order No.
M 20	with thread		50	HDC 04A TOLU 1M20G	1788820000

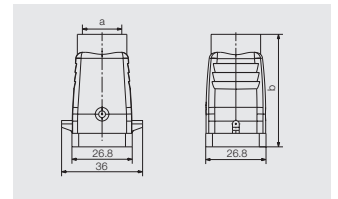

Base

Bulkhead housing



Version	Cover	b (mm)	Designation	Order No.
		23	HDC 04A ALU	1497600000

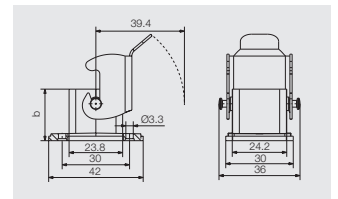

Base housing



a	Version	Cover	b (mm)	Designation	Order No.
M 20	with thread		25,8	HDC 04A SLU 1M20G	1788830000

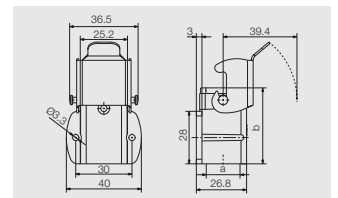

Coupling hood



a	Version	Cover	b (mm)	Designation	Order No.
M 20	with thread		53,5	HDC 04A KOLU 1M20G	1788840000

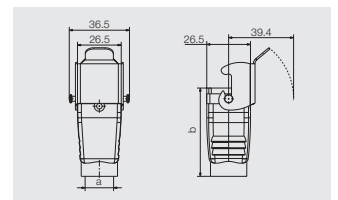

Screw Mounting Housing



a	Version	Cover	b (mm)	Designation	Order No.
M 20	with thread		54	HDC 04A ELU 1M20G	1900320000
PG 13,5	with thread		54	HDC 04A ELU 1PG13G	1900330000
PG 13,5	with thread		54	HDC 04A ELU 1PG13G EXI	1900350000

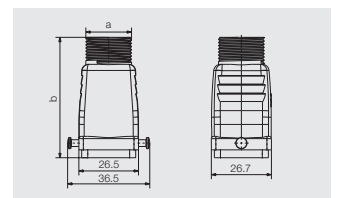

Cover



Version	Designation	Order No.
for female insert	HDC 04A DMDL 2BO	1665750000
for male insert	HDC 04A DODL 2BO	1665740000

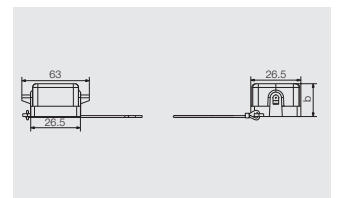

HA series - the slim connectors

250 V, 22 A, Size 2

10 + ⊕



Inserts

Tension clamp connection



Insert	Designation	Order No.
Male	HDC HA 10 MT	1896790000
Female	HDC HA 10 FT	1896780000

Dimensions

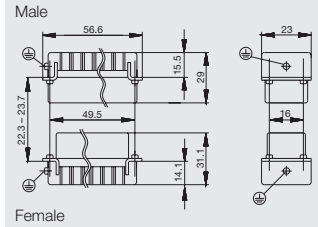

Screw connection



Insert	Designation	Order No.
Male	HDC HA 10 MS	1650610000
Female	HDC HA 10 FS	1650620000

Arrangement of contacts

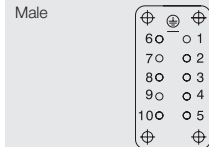

Crimp connection



Insert	Designation	Order No.
Female	HDC HA 10 FC	1873860000
Male	HDC HA 10 MC	1873870000

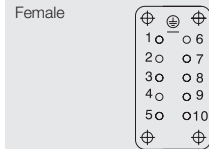

Mounting cut-out

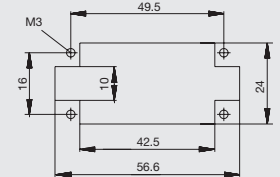

Accessories

Crimp contacts

Surface silver



Surface gold



Qty.	Male	Order No.	Female	Order No.
100	HDC-C-HE-SM0.5AG	1200500000	HDC-C-HE-BM0.5AG	1201100000
100	HDC-C-HE-SM0.75-1AG	1200600000	HDC-C-HE-BM0.75-1AG	1201200000
100	HDC-C-HE-SM1.5AG	1200700000	HDC-C-HE-BM1.5AG	1201300000
100	HDC-C-HE-SM2.5AG	1200800000	HDC-C-HE-BM2.5AG	1201400000
100	HDC-C-HE-SM4.0AG	1200900000	HDC-C-HE-BM4.0AG	1201500000
100	HDC-C-HE-SM0.5AU	1651420000	HDC-C-HE-BM0.5AU	1651470000
100	HDC-C-HE-SM0.75-1AU	1651430000	HDC-C-HE-BM0.75-1AU	1651480000
100	HDC-C-HE-SM1.5AU	1651440000	HDC-C-HE-BM1.5AU	1651490000
100	HDC-C-HE-SM2.5AU	1651450000	HDC-C-HE-BM2.5AU	1651500000
100	HDC-C-HE-SM4.0AU	1651460000	HDC-C-HE-BM4.0AU	1651510000

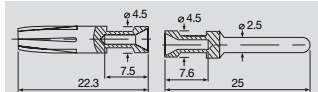

Single contacts

Conductor mm ²	AWG No.
0.50	20
0.75-1.00	18
1.50	16
2.50	14
4.00	12

Tools



Tool	Order No.
Crimping tool CTX CM 1.6/2.5	9018490000
Contact removal tool Removal Tool HE	1866750000

Selection of Housings RockStar® IP65
Size 2



Hood

Hood, Cable Entry sideways



a	Version	Cover	b (mm)	Designation	Order No.
M 20	with thread		68	HDC 15A TSLU 1M20G	1788860000
M 25	with thread		68	HDC 15A TSLU 1M25G	1788850000

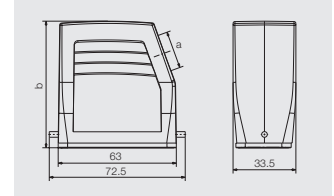

Hood, Cable Entry at top



a	Version	Cover	b (mm)	Designation	Order No.
M 20	with thread		54	HDC 10A TOLU 1M20G	1788620000
M 25	with thread		54	HDC 10A TOLU 1M25G	1788610000

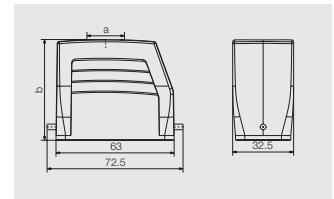

Cover



Version	Designation	Order No.
for hoods	HDC 10A DODL 1LB	1665890000

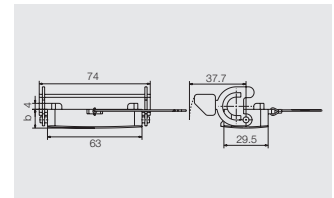

Base

Bulkhead housing



Version	Cover	b (mm)	Designation	Order No.
	with cover	37.5	HDC 10A ADLU	1664060000
		25	HDC 10A ALU	1664040000

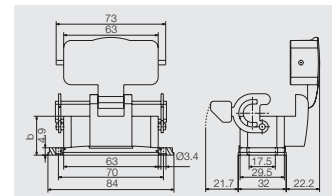

Base housing



a	Version	Cover	b (mm)	Designation	Order No.
M 20	with thread	with cover	69.5	HDC 10A SDLU 2M20G	1788660000
M 25	with thread	with cover	69.5	HDC 10A SDLU 2M25G	1788650000
M 20	with thread		57	HDC 10A SLU 2M20G	1788640000
M 25	with thread		57	HDC 10A SLU 2M25G	1788630000

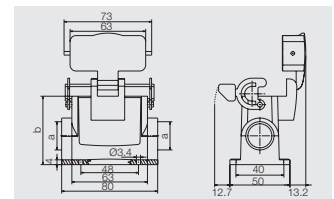

Coupling hood



a	Version	Cover	b (mm)	Designation	Order No.
M 25	with thread		48	HDC 10A KLU 1M25G	1788670000

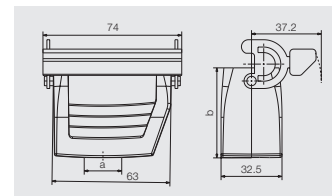

Cover



Version	Designation	Order No.
for bases	HDC 10A DMDL 2BO	1665880000

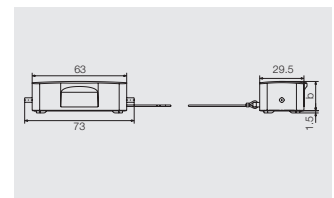

HA series - the slim connectors

250 V, 22 A, Size 5

16 + ⊕

Inserts



Tension clamp connection



Insert	Designation	Order No.
Male	HDC HA 16 MT	1896830000
Female	HDC HA 16 FT	1896800000

Screw connection



Insert	Designation	Order No.
Male	HDC HA 16 MS	1650770000
Female	HDC HA 16 FS	1650780000

Crimp connection



Insert	Designation	Order No.
Male	HDC HA 16 MC	1873890000
Female	HDC HA 16 FC	1873880000

Dimensions

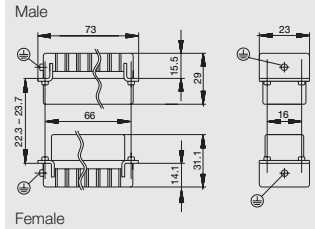

Arrangement of contacts

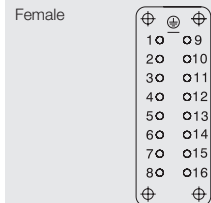
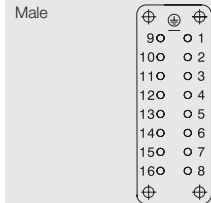

Mounting cut-out

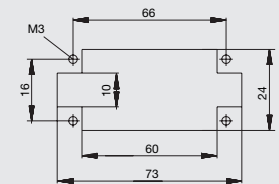

Accessories

Crimp contacts

Surface silver



Surface gold



Qty.	Male	Order No.	Female	Order No.
100	HDC-C-HE-SM0.5AG	1200500000	HDC-C-HE-BM0.5AG	1201100000
100	HDC-C-HE-SM0.75-1AG	1200600000	HDC-C-HE-BM0.75-1AG	1201200000
100	HDC-C-HE-SM1.5AG	1200700000	HDC-C-HE-BM1.5AG	1201300000
100	HDC-C-HE-SM2.5AG	1200800000	HDC-C-HE-BM2.5AG	1201400000
100	HDC-C-HE-SM4.0AG	1200900000	HDC-C-HE-BM4.0AG	1201500000
100	HDC-C-HE-SM0.5AU	1651420000	HDC-C-HE-BM0.5AU	1651470000
100	HDC-C-HE-SM0.75-1AU	1651430000	HDC-C-HE-BM0.75-1AU	1651480000
100	HDC-C-HE-SM1.5AU	1651440000	HDC-C-HE-BM1.5AU	1651490000
100	HDC-C-HE-SM2.5AU	1651450000	HDC-C-HE-BM2.5AU	1651500000
100	HDC-C-HE-SM4.0AU	1651460000	HDC-C-HE-BM4.0AU	1651510000

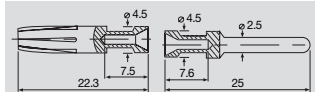

Single contacts

Conductor mm ²	AWG No.
0.50	20
0.75-1.00	18
1.50	16
2.50	14
4.00	12

Tools



Tool	Order No.
Crimping tool CTX CM 1.6/2.5	9018490000
Contact removal tool Removal Tool HE	1866750000

**Selection of Housings RockStar® IP65
Size 5**



Hood

Hood, Cable Entry sideways



a	Version	Cover	b (mm)	Designation	Order No.
M 25	with thread		58	HDC 16A TSLU 1M25G	1788740000
M 20	with thread		72	HDC 25A TSLU 1M20G	1788680000
M 25	with thread		72	HDC 25A TSLU 1M25G	1788690000

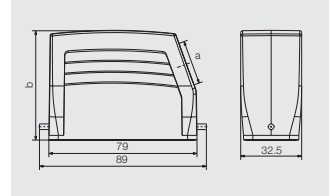

Hood, Cable Entry at top



a	Version	Cover	b (mm)	Designation	Order No.
M 25	with thread		58	HDC 16A TOLU 1M25G	1788750000
M 20	with thread		72	HDC 25A TOLU 1M20G	1788710000
M 25	with thread		72	HDC 25A TOLU 1M25G	1788700000

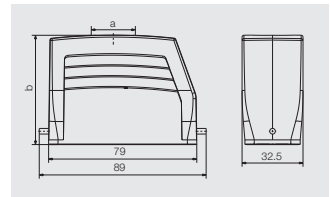

Cover



Version	Designation	Order No.
for hoods	HDC 16A DODL 1LB	1665900000

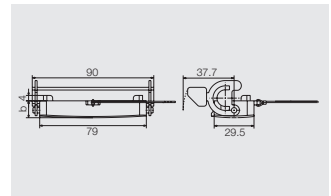

Base

Bulkhead housing



Version	Cover	b (mm)	Designation	Order No.
	with cover	44.5	HDC 16A ADLU	1664940000
		25	HDC 16A ALU	1664920000

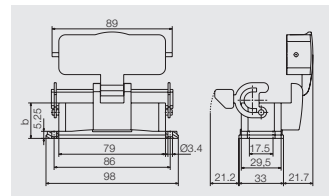

Base housing



a	Version	Cover	b (mm)	Designation	Order No.
M 20	with thread	with cover	76.5	HDC 16A SDLU 2M20G	1788790000
M 25	with thread	with cover	76.5	HDC 16A SDLU 2M25G	1788780000
M 20	with thread		57	HDC 16A SLU 2M20G	1788770000
M 25	with thread		57	HDC 16A SLU 2M25G	1788760000

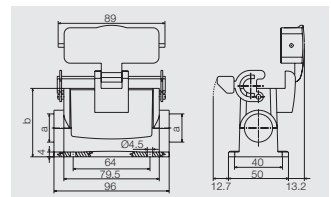

Coupling hood



a	Version	Cover	b (mm)	Designation	Order No.
M 25	with thread		53	HDC 16A KLU 1M25G	1788800000

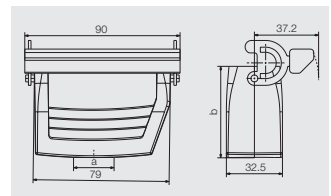

Cover



Version	Designation	Order No.
for bases	HDC 16A DMDL 2BO	1665910000

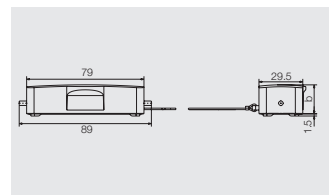

HA series - the slim connectors

250 V, 16 A, Size 7

32 + ⊕

Inserts



Tension clamp connection



Insert	Designation	Order No.
Male	HDC HA 16 MT	1896830000
Female	HDC HA 16 FT	1896800000
Male	HDC HA 16 MT 17-32	1896840000
Female	HDC HA 16 FT 17-32	1896810000

Screw connection



Insert	Designation	Order No.
Male	HDC HA 16 MS	1650770000
Female	HDC HA 16 FS	1650780000
Male	HDC HA 16 MS 17-32	1650880000
Female	HDC HA 16 FS 17-32	1650900000

Crimp connection

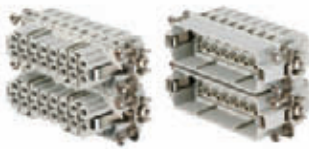

Insert	Designation	Order No.
Male	HDC HA 16 MC	1873890000
Female	HDC HA 16 FC	1873880000
Male	HDC HA 16 MC 17-32	1875620000
Female	HDC HA 16 FC 17-32	1876040000

Dimensions

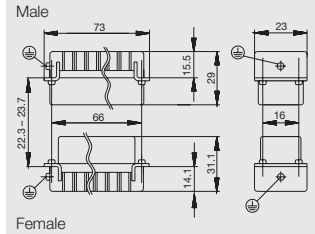

Arrangement of contacts

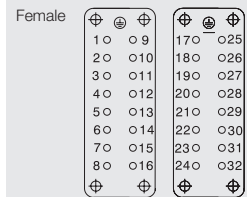
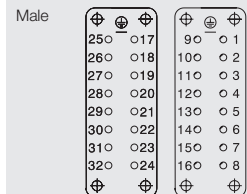

Mounting cut-out

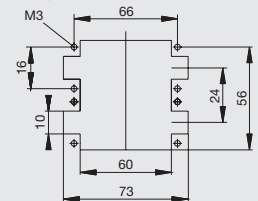

Accessories

Crimp contacts

Surface silver



Surface gold



Qty.	Male	Order No.	Female	Order No.
100	HDC-C-HE-SM0.5AG	1200500000	HDC-C-HE-BM0.5AG	1201100000
100	HDC-C-HE-SM0.75-1AG	1200600000	HDC-C-HE-BM0.75-1AG	1201200000
100	HDC-C-HE-SM1.5AG	1200700000	HDC-C-HE-BM1.5AG	1201300000
100	HDC-C-HE-SM2.5AG	1200800000	HDC-C-HE-BM2.5AG	1201400000
100	HDC-C-HE-SM4.0AG	1200900000	HDC-C-HE-BM4.0AG	1201500000
100	HDC-C-HE-SM0.5AU	1651420000	HDC-C-HE-BM0.5AU	1651470000
100	HDC-C-HE-SM0.75-1AU	1651430000	HDC-C-HE-BM0.75-1AU	1651480000
100	HDC-C-HE-SM1.5AU	1651440000	HDC-C-HE-BM1.5AU	1651490000
100	HDC-C-HE-SM2.5AU	1651450000	HDC-C-HE-BM2.5AU	1651500000
100	HDC-C-HE-SM4.0AU	1651460000	HDC-C-HE-BM4.0AU	1651510000

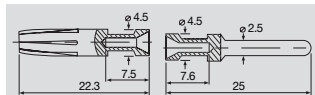

Single contacts

Conductor mm ²	AWG No.
0.50	20
0.75-1.00	18
1.50	16
2.50	14
4.00	12

Tools



Tool	Order No.
Crimping tool CTX CM 1.6/2.5	9018490000
Contact removal tool Removal Tool HE	1866750000

Selection of Housings RockStar® IP65
Size 7



Hood

Hood, Cable Entry sideways



a	Version	Cover	b (mm)	Designation	Order No.
M 25	with thread		75	HDC 32A TSBU 1M25G	1787960000
M 32	with thread		75	HDC 32A TSBU 1M32G	1787950000

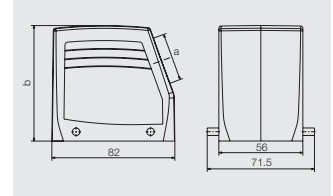

Hood, Cable Entry at top



a	Version	Cover	b (mm)	Designation	Order No.
M 32	with thread		75	HDC 32A TOBU 1M32G	1787990000

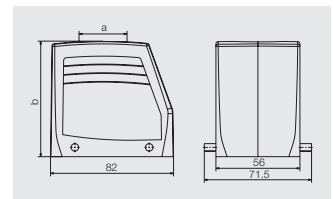

Base

Bulkhead housing



Version	Cover	b (mm)	Designation	Order No.
		25	HDC 32A ABU	1665860000

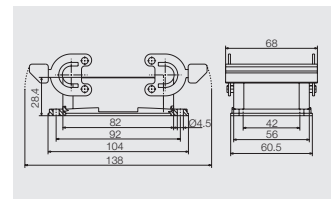

Base housing



a	Version	Cover	b (mm)	Designation	Order No.
M 25	with thread		75	HDC 32A SBU 2M25G	1788040000

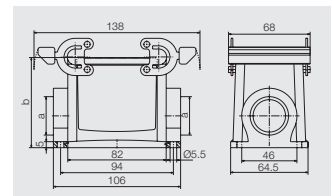

Coupling hood



a	Version	Cover	b (mm)	Designation	Order No.
M 25	with thread		76.5	HDC 32A KBU 1M25G	1788080000
M 32	with thread		76.5	HDC 32A KBU 1M32G	1788070000

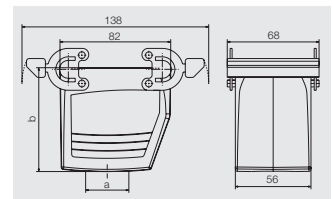

HA series - the slim connectors

250 V, 16 A, Size 9

48 + ⊕

Inserts



Tension clamp connection



Insert	Designation	Order No.
Male	HDC HA 16 MT	1896830000
Female	HDC HA 16 FT	1896800000
Male	HDC HA 16 MT 17-32	1896840000
Female	HDC HA 16 FT 17-32	1896810000
Male	HDC HA 16 MT 33-48	1896850000
Female	HDC HA 16 FT 33-48	1896820000

Screw connection



Insert	Designation	Order No.
Male	HDC HA 16 MS	1650770000
Female	HDC HA 16 FS	1650780000
Male	HDC HA 16 MS 17-32	1650880000
Female	HDC HA 16 FS 17-32	1650900000
Male	HDC HA 16 MS 33-48	1650990000
Female	HDC HA 16 FS 33-48	1651020000

Crimp connection



Insert	Designation	Order No.
Male	HDC HA 16 MC	1873890000
Female	HDC HA 16 FC	1873880000
Male	HDC HA 16 MC 17-32	1875620000
Female	HDC HA 16 FC 17-32	1876040000
Male	HDC HA 16 MC 33-48	1875630000
Female	HDC HA 16 FC 33-48	1875540000

Dimensions

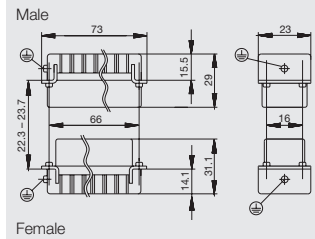

Arrangement of contacts

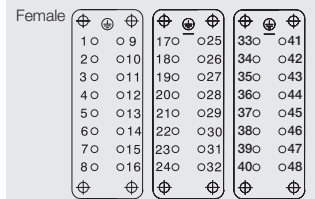
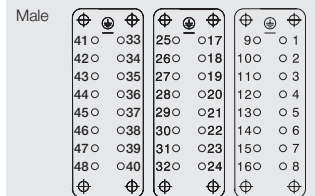

Mounting cut-out

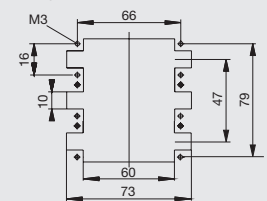

Accessories

Crimp contacts

Surface silver



Surface gold



Qty.	Male	Order No.	Female	Order No.
100	HDC-C-HE-SM0.5AG	1200500000	HDC-C-HE-BM0.5AG	1201100000
100	HDC-C-HE-SM0.75-1AG	1200600000	HDC-C-HE-BM0.75-1AG	1201200000
100	HDC-C-HE-SM1.5AG	1200700000	HDC-C-HE-BM1.5AG	1201300000
100	HDC-C-HE-SM2.5AG	1200800000	HDC-C-HE-BM2.5AG	1201400000
100	HDC-C-HE-SM4.0AG	1200900000	HDC-C-HE-BM4.0AG	1201500000
100	HDC-C-HE-SM0.5AU	1651420000	HDC-C-HE-BM0.5AU	1651470000
100	HDC-C-HE-SM0.75-1AU	1651430000	HDC-C-HE-BM0.75-1AU	1651480000
100	HDC-C-HE-SM1.5AU	1651440000	HDC-C-HE-BM1.5AU	1651490000
100	HDC-C-HE-SM2.5AU	1651450000	HDC-C-HE-BM2.5AU	1651500000
100	HDC-C-HE-SM4.0AU	1651460000	HDC-C-HE-BM4.0AU	1651510000

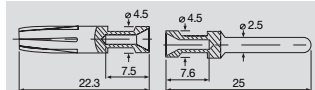

Single contacts

Conductor mm ²	AWG No.
0.50	20
0.75-1.00	18
1.50	16
2.50	14
4.00	12

Tools



Tool	Order No.
Crimping tool CTX CM 1.6/2.5	9018490000
Contact removal tool Removal Tool HE	1866750000

Selection of Housings RockStar® IP65
Size 9



Hood

Hood, Cable Entry sideways



a	Version	Cover	b (mm)	Designation	Order No.
M 32	with thread		79	HDC 48A TSLU 1M32G	1788550000

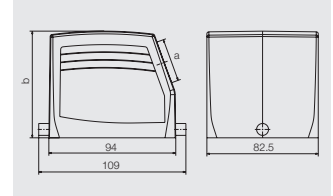

Hood, Cable Entry at top



a	Version	Cover	b (mm)	Designation	Order No.
M 32	with thread		79	HDC 48A TOLU 1M32G	1788560000

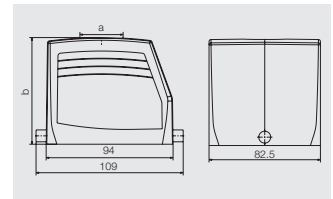

Base

Bulkhead housing



Version	Cover	b (mm)	Designation	Order No.
	with cover	53	HDC 48A ADLU	1666750000
		36	HDC 48A ALU	1666740000

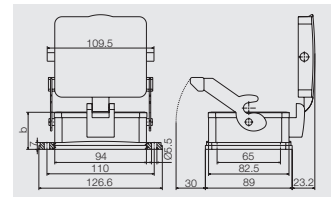

Base housing



a	Version	Cover	b (mm)	Designation	Order No.
M 32	with thread		79	HDC 48A SLU 2M32G	1788570000

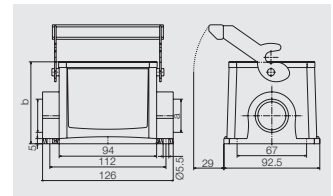

HE series – the universal connectors

With the HE series, users are free to choose the connection system for the conductor. In addition to the proven tension clamp connection, screw and crimp connections are available.

Furthermore, Weidmüller is the first manufacturer to offer this series in push-in design.

Simply choose the connection system you need.

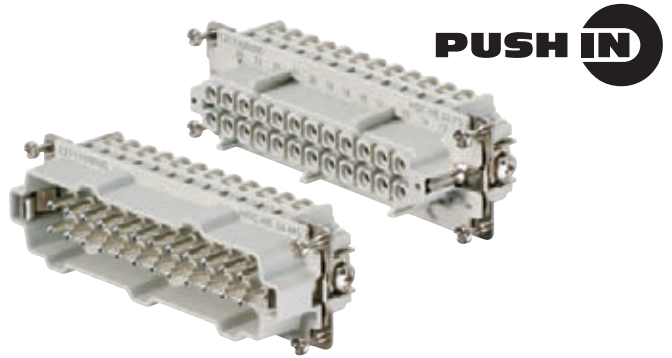

Technical data





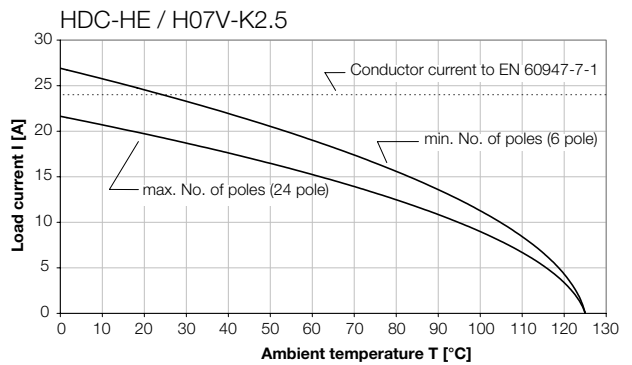
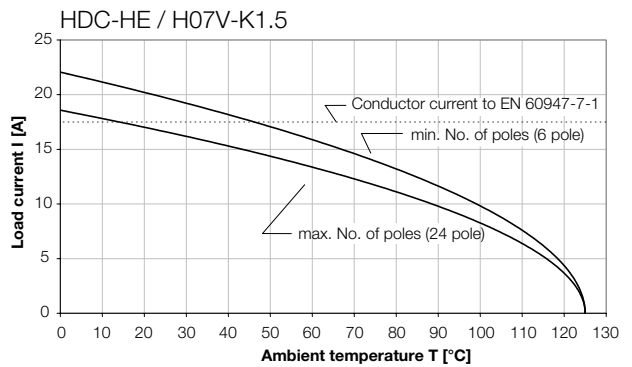

Standards / approvals	
Standards	DIN EN 61984 DIN EN 60664-1
Approvals	UL/CSA
Inserts	
No. of poles	6, 10, 16, 24, 32, 48
Rated voltage	500 V
Rated voltage to UL/CSA	600 V
Rated current	16 A (6 poles 24 A)
Rated impulse withstand voltage	6 kV
Pollution severity	3
Insulation resistance	$\geq 10^{10} \Omega$
Material	Glass-fibre reinforced PC (in UL list and approved for railway applications)
Temperature range	-40 °C ... +125 °C
Flammability to UL 94	V-0
Mechanical service life	
- Plugging cycles Ag - Surface	≥ 500
- Plugging cycles Au - Surface	≥ 500
Contact resistance	
Crimp connection	$\leq 4 \text{ m}\Omega$
Screw tension clamp + Push In	$\leq 2 \text{ m}\Omega$
Contacts / Material	
Sockets and plug-in contact	Copper alloy
Surface	Passivated silver, or 0.8 μm gold on 2 μm nickel
Clamping unit / Screw connection	Copper alloy / Passivated silver
Clamping range / Stripping length	
- Crimp connection	
- Flexible conductor connection	0.5 ... 4 mm ² (AWG 20 ... 12)
- Stripping length	7.5 mm
- Screw connection	0.5 - 2.5 mm ² (AWG 20 ... 14) / 9 mm
- Push In	0.5 - 2.5 mm ² (AWG 20 ... 14) / 8 mm
- Tension clamp connection	0.5 - 2.5 mm ² (AWG 20 ... 14) / 8 mm
Clamping torque	
- Screw connection	0.5 - 0.55 Nm
SD blades	
- Screw connection	0.6 x 3.5 or PZ 0
- Push In	0.4 x 2.5
- Tension clamp connection	0.5 x 3 or 0.6 x 3,5
PE connection	
- Clamping range	0.5 ... 4 mm ²
- solid / stranded	0.5 ... 4 mm ² / 0.5 ... 4 mm ²
- flexible / flexible with wire end ferrule, DIN 46228 pt. 1	0.5 ... 4 mm ² / 0.5 ... 4 mm ²
- AWG conductor	AWG 20 ... 12
- Stripping length	10 mm
- Clamping torque	1.2 ... 1.5 Nm
- Blade dimensions	SD 0.8 x 4 mm or PZ 1

Note: Switch off power supply before handling plug-in connectors.
Inserts with push-in connection can be connected to the H07V-U4 conductor.

Derating curves



Overview

	Rated voltage	Rated current	No. of poles	Tension clamp connection	Screw conn. with wire guard spring	Crimp connection	Push In	Axial screw connection	Page
	500 V	24 A	6 + ⊕	•	•	•	•		B.18
	500 V	16 A	10 + ⊕	•	•	•	•		B.20
	500 V	16 A	16 + ⊕	•	•	•	•		B.22
	500 V	16 A	24 + ⊕	•	•	•	•		B.24
	500 V	16 A	32 + ⊕	•	•	•	•		B.26
	500 V	16 A	48 + ⊕	•	•	•	•		B.28

HE series - the universal connectors

500 V, 24 A, Size 3

6 + ⊕

Inserts



Tension clamp connection



Insert	Designation	Order No.
Male	HDC HE 6 MT	1745820000
Female	HDC HE 6 FT	1745760000

Screw connection



Insert	Designation	Order No.
Male	HDC HE 6 MS	1200000000
Female	HDC HE 6 FS	1200200000

Push In connection



Insert	Designation	Order No.
Male	HDC HE 6 MP	1873530000
Female	HDC HE 6 FP	1873520000

Crimp connection



Insert	Designation	Order No.
Male	HDC HE 6 MC	1200400000
Female	HDC HE 6 FC	1201000000

Dimensions

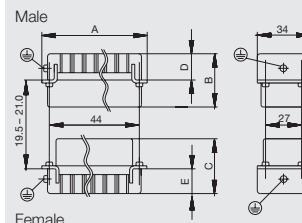

A (mm)	B (mm)	C (mm)	D (mm)	E (mm)
49.80	33.80	33.20	19.10	16.50

Arrangement of contacts

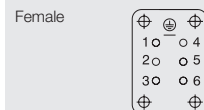
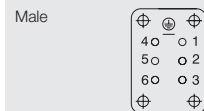

Mounting cut-out

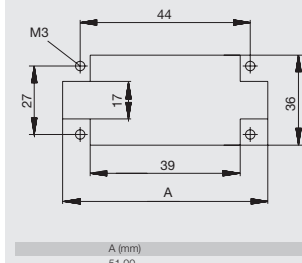

Accessories

Crimp contacts

Surface silver



Surface gold



Qty.	Male	Order No.	Female	Order No.
100	HDC-C-HE-SM0.5AG	1200500000	HDC-C-HE-BM0.5AG	1201100000
100	HDC-C-HE-SM0.75-1AG	1200600000	HDC-C-HE-BM0.75-1AG	1201200000
100	HDC-C-HE-SM1.5AG	1200700000	HDC-C-HE-BM1.5AG	1201300000
100	HDC-C-HE-SM2.5AG	1200800000	HDC-C-HE-BM2.5AG	1201400000
100	HDC-C-HE-SM4.0AG	1200900000	HDC-C-HE-BM4.0AG	1201500000
100	HDC-C-HE-SM0.5AU	1651420000	HDC-C-HE-BM0.5AU	1651470000
100	HDC-C-HE-SM0.75-1AU	1651430000	HDC-C-HE-BM0.75-1AU	1651480000
100	HDC-C-HE-SM1.5AU	1651440000	HDC-C-HE-BM1.5AU	1651490000
100	HDC-C-HE-SM2.5AU	1651450000	HDC-C-HE-BM2.5AU	1651500000
100	HDC-C-HE-SM4.0AU	1651460000	HDC-C-HE-BM4.0AU	1651510000

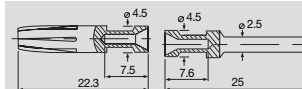

Single contacts	AWG No.
Conductor mm ²	
0.50	20
0.75-1.00	18
1.50	16
2.50	14
4.00	12

Tools



Tool	Order No.
Crimping tool	
CTX CM 1.6/2.5	9018490000
Contact removal tool	
Removal Tool HE	1866750000

**Selection of Housings RockStar® IP65
Size 3**



Hood

Hood, Cable Entry sideways



a	Version	Cover	b (mm)	Designation	Order No.
M 20	with thread		52	HDC 06B TSLU 1M20G	1788100000
M 20	with thread		52	HDC 06B TSLU 1M20G	1805930000
M 25	with thread		52	HDC 06B TSLU 1M25G	1788090000
M 25	with thread		72	HDC 16D TSLU 1M25G	1787480000

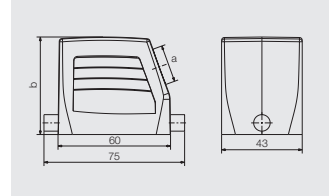

Hood, Cable Entry at top



a	Version	Cover	b (mm)	Designation	Order No.
M 20	with thread		52	HDC 06B TOLU 1M20G	1788120000
M 25	with thread		52	HDC 06B TOLU 1M25G	1788110000
M 25	with thread		72	HDC 16D TOLU 1M25G	1787500000
M 32	with thread		72	HDC 16D TOLU 1M32G	1787490000

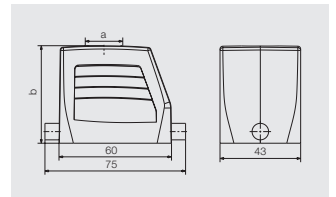

Cover



Version	Designation	Order No.
for hoods	HDC 06B DMDL 1LB	1665210000

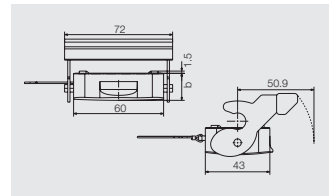

Base

Bulkhead housing



Version	Cover	b (mm)	Designation	Order No.
		29	HDC 06B ALU	1202100000
	with cover	47	HDC 06B ADLU	1202500000

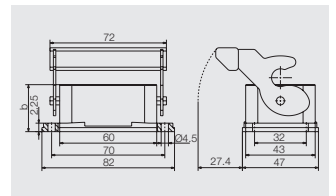

Base housing



a	Version	Cover	b (mm)	Designation	Order No.
M 20	with thread		54	HDC 06B SLU 2M20G	1788140000
M 20	with thread	with cover	72	HDC 06B SDLU 2M20G	1788170000
M 25	with thread		54	HDC 06B SLU 2M25G	1788130000
M 25	with thread	with cover	72	HDC 06B SDLU 2M25G	1788160000

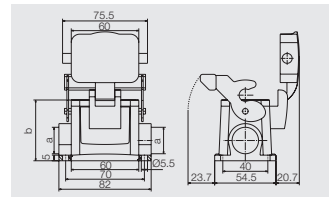

Cover



Version	Designation	Order No.
for bases	HDC 06B DODL 2BO	1665200000

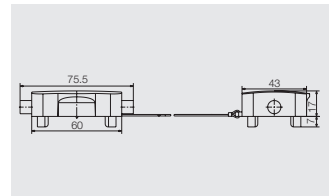

HE series - the universal connectors

500 V, 16 A, Size 4

10 + ⊕

Inserts



Tension clamp connection



Insert	Designation	Order No.
Male	HDC HE 10 MT	1745830000
Female	HDC HE 10 FT	1745770000

Screw connection



Insert	Designation	Order No.
Female	HDC HE 10 FS	1204100000
Male	HDC HE 10 MS	1203900000

Push In connection



Insert	Designation	Order No.
Male	HDC HE 10 MP	1873550000
Female	HDC HE 10 FP	1873540000

Crimp connection



Insert	Designation	Order No.
Male	HDC HE 10 MC	1204300000
Female	HDC HE 10 FC	1204400000

Dimensions

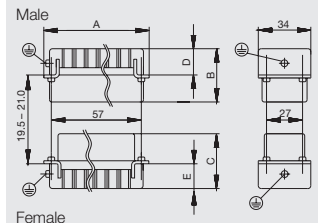

A (mm)	B (mm)	C (mm)	D (mm)	E (mm)
62.80	33.80	33.20	19.10	16.50

Arrangement of contacts

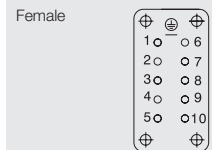
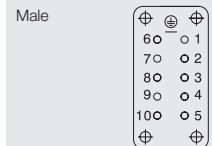

Mounting cut-out

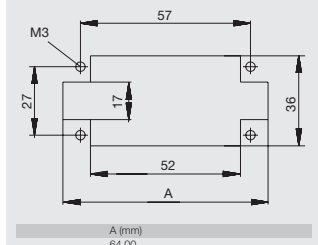

Accessories

Crimp contacts

Surface silver



Surface gold



Qty.	Male	Order No.	Female	Order No.
100	HDC-C-HE-SM0.5AG	1200500000	HDC-C-HE-BM0.5AG	1201100000
100	HDC-C-HE-SM0.75-1AG	1200600000	HDC-C-HE-BM0.75-1AG	1201200000
100	HDC-C-HE-SM1.5AG	1200700000	HDC-C-HE-BM1.5AG	1201300000
100	HDC-C-HE-SM2.5AG	1200800000	HDC-C-HE-BM2.5AG	1201400000
100	HDC-C-HE-SM4.0AG	1200900000	HDC-C-HE-BM4.0AG	1201500000
100	HDC-C-HE-SM0.5AU	1651420000	HDC-C-HE-BM0.5AU	1651470000
100	HDC-C-HE-SM0.75-1AU	1651430000	HDC-C-HE-BM0.75-1AU	1651480000
100	HDC-C-HE-SM1.5AU	1651440000	HDC-C-HE-BM1.5AU	1651490000
100	HDC-C-HE-SM2.5AU	1651450000	HDC-C-HE-BM2.5AU	1651500000
100	HDC-C-HE-SM4.0AU	1651460000	HDC-C-HE-BM4.0AU	1651510000

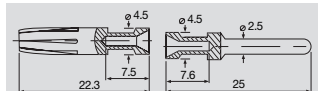

Single contacts	Conductor mm ²	AWG No.
	0.50	20
	0.75-1.00	18
	1.50	16
	2.50	14
	4.00	12

Tools



Tool	Order No.
Crimping tool CTX CM 1.6/2.5	9018490000
Contact removal tool Removal Tool HE	1866750000

Selection of Housings RockStar® IP65
Size 4



Hood

Hood, Cable Entry sideways



a	Version	Cover	b (mm)	Designation	Order No.
M 20	with thread		52	HDC 10B TSBU 1M20G	1787560000
M 25	with thread		52	HDC 10B TSBU 1M25G	1787550000
M 25	with thread		72	HDC 24D TSBU 1M25G	1787240000
M 32	with thread		72	HDC 24D TSBU 1M32G	1787230000



Hood, Cable Entry at top



a	Version	Cover	b (mm)	Designation	Order No.
M 20	with thread		52	HDC 10B TOBU 1M20G	1787600000
M 25	with thread		52	HDC 10B TOBU 1M25G	1787590000
M 25	with thread		72	HDC 24D TOBU 1M25G	1787300000
M 32	with thread		72	HDC 24D TOBU 1M32G	1787290000

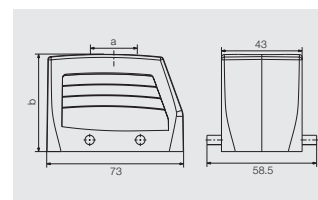

Cover



Version	Designation	Order No.
for hoods	HDC 10B DMDQ 2QB	1665240000

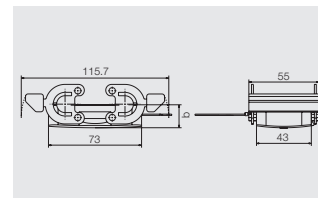

Base

Bulkhead housing



Version	Cover	b (mm)	Designation	Order No.
		29.3	HDC 10B ABU	1205000000

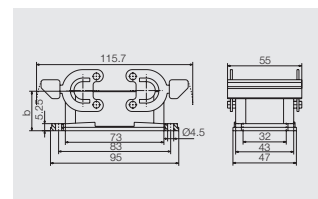

Base housing



a	Version	Cover	b (mm)	Designation	Order No.
M 20	with thread		57	HDC 10B SBU 2M20G	1787640000
M 25	with thread		57	HDC 10B SBU 2M25G	1787630000
M 25	with thread		74	HDC 24D SBU 2M25G	1787350000
M 32	with thread		74	HDC 24D SBU 2M32G	1787360000

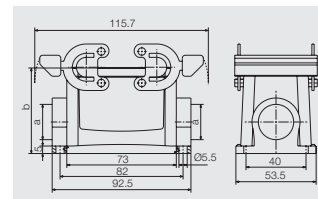

Coupling hood



a	Version	Cover	b (mm)	Designation	Order No.
M 20	with thread		55	HDC 10B KBU 1M20G	1787720000

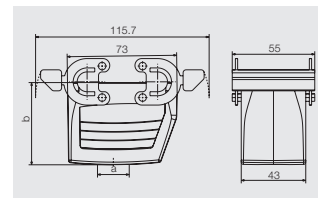

Cover



Version	Designation	Order No.
for bases	HDC 10B DODQ 4BO	1665230000

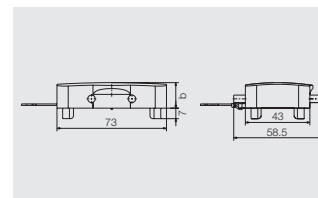

HE series - the universal connectors

500 V, 16 A, Size 6

16 + ⊕

Inserts



Tension clamp connection



Insert	Designation	Order No.
Male	HDC HE 16 MT	1745840000
Female	HDC HE 16 FT	1745780000

Dimensions

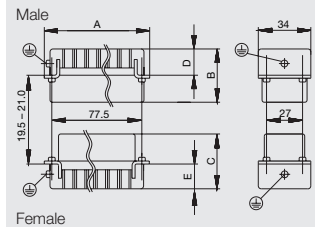

A (mm)	B (mm)	C (mm)	D (mm)	E (mm)
83.30	33.80	33.20	19.10	16.50

Screw connection



Insert	Designation	Order No.
Male	HDC HE 16 MS	1207500000
Female	HDC HE 16 FS	1207700000

Arrangement of contacts

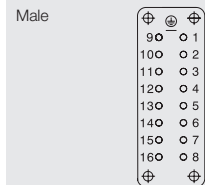

Push In connection



Insert	Designation	Order No.
Male	HDC HE 16 MP	1873570000
Female	HDC HE 16 FP	1873560000

Mounting cut-out

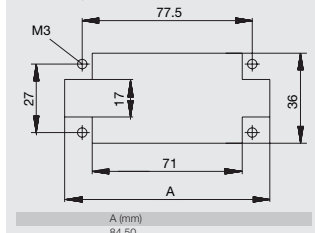

Crimp connection



Insert	Designation	Order No.
Male	HDC HE 16 MC	1207900000
Female	HDC HE 16 FC	1208000000

Accessories

Crimp contacts

Surface silver



Surface gold



Qty.	Male	Order No.	Female	Order No.
100	HDC-C-HE-SM0.5AG	1200500000	HDC-C-HE-BM0.5AG	1201100000
100	HDC-C-HE-SM0.75-1AG	1200600000	HDC-C-HE-BM0.75-1AG	1201200000
100	HDC-C-HE-SM1.5AG	1200700000	HDC-C-HE-BM1.5AG	1201300000
100	HDC-C-HE-SM2.5AG	1200800000	HDC-C-HE-BM2.5AG	1201400000
100	HDC-C-HE-SM4.0AG	1200900000	HDC-C-HE-BM4.0AG	1201500000
100	HDC-C-HE-SM0.5AU	1651420000	HDC-C-HE-BM0.5AU	1651470000
100	HDC-C-HE-SM0.75-1AU	1651430000	HDC-C-HE-BM0.75-1AU	1651480000
100	HDC-C-HE-SM1.5AU	1651440000	HDC-C-HE-BM1.5AU	1651490000
100	HDC-C-HE-SM2.5AU	1651450000	HDC-C-HE-BM2.5AU	1651500000
100	HDC-C-HE-SM4.0AU	1651460000	HDC-C-HE-BM4.0AU	1651510000

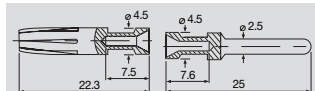

Single contacts	AWG No.
Conductor mm ²	
0.50	20
0.75-1.00	18
1.50	16
2.50	14
4.00	12

Tools



Tool	Order No.
Crimping tool	
CTX CM 1.6/2.5	9018490000
Contact removal tool	
Removal Tool HE	1866750000

**Selection of Housings RockStar® IP65
Size 6**



Hood

Hood, Cable Entry sideways



a	Version	Cover	b (mm)	Designation	Order No.
M 25	with thread		61	HDC 16B TSBU 1M25G	1788180000
M 25	with thread		76	HDC 40D TSBU 1M25G	1787010000
M 32	with thread		76	HDC 40D TSBU 1M32G	1787000000

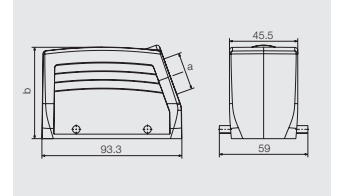

Hood, Cable Entry at top



a	Version	Cover	b (mm)	Designation	Order No.
M 25	with thread		61	HDC 16B TOBU 1M25G	1788210000
M 25	with thread		76	HDC 40D TOBU 1M25G	1787070000
M 32	with thread		76	HDC 40D TOBU 1M32G	1787060000

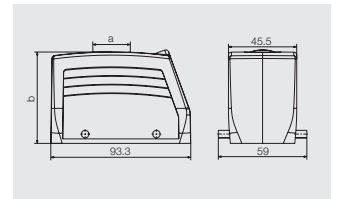

Cover

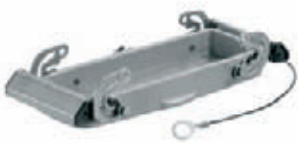

Version	Designation	Order No.
for hoods	HDC 16B DMDQ 2QB	1665270000

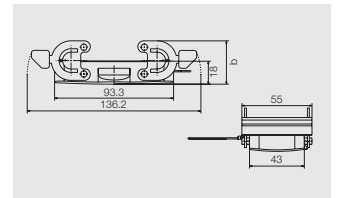

Base

Bulkhead housing



Version	Cover	b (mm)	Designation	Order No.
		29	HDC 16B ABU	1208600000

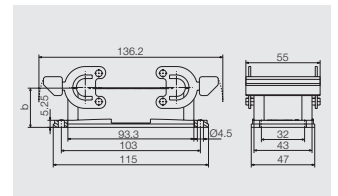

Base housing



a	Version	Cover	b (mm)	Designation	Order No.
M 25	with thread		64	HDC 16B SBU 2M25G	1788240000
M 25	with thread		84	HDC 40D SBU 2M25G	1787120000
M 32	with thread		84	HDC 40D SBU 2M32G	1787110000

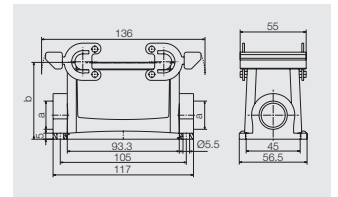

Coupling hood



a	Version	Cover	b (mm)	Designation	Order No.
M 25	with thread		79	HDC 40D KBU 1M25G	1787200000
M 32	with thread		79	HDC 40D KBU 1M32G	1787190000

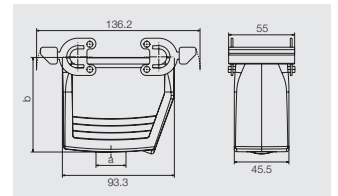

Cover



Version	Designation	Order No.
for bases	HDC 16B DODQ 4BO	1665260000

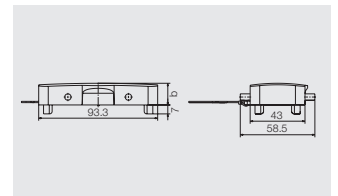

HE series - the universal connectors

500 V, 16 A, Size 8

24 + ⊕

Inserts



Tension clamp connection



Insert	Designation	Order No.
Male	HDC HE 24 MT	1745850000
Female	HDC HE 24 FT	1745790000

Dimensions

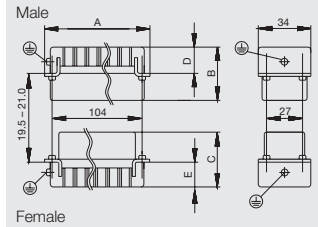

A (mm)	B (mm)	C (mm)	D (mm)	E (mm)
109.80	33.80	33.20	19.10	16.50

Screw connection



Insert	Designation	Order No.
Male	HDC HE 24 MS	1211100000
Female	HDC HE 24 FS	1211300000

Arrangement of contacts

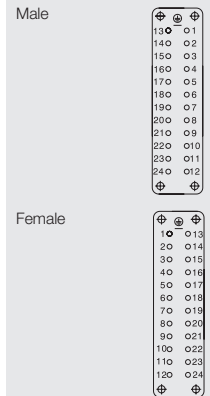

Push In connection



Insert	Designation	Order No.
Male	HDC HE 24 MP	1873590000
Female	HDC HE 24 FP	1873580000

Mounting cut-out

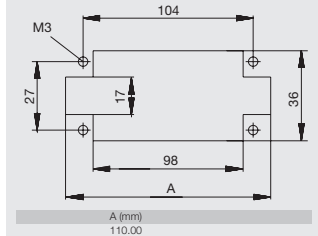

Crimp connection



Insert	Designation	Order No.
Male	HDC HE 24 MC	1211500000
Female	HDC HE 24 FC	1211600000

Accessories

Crimp contacts

Surface silver



Surface gold



Qty.	Male	Order No.	Female	Order No.
100	HDC-C-HE-SM0.5AG	1200500000	HDC-C-HE-BM0.5AG	1201100000
100	HDC-C-HE-SM0.75-1AG	1200600000	HDC-C-HE-BM0.75-1AG	1201200000
100	HDC-C-HE-SM1.5AG	1200700000	HDC-C-HE-BM1.5AG	1201300000
100	HDC-C-HE-SM2.5AG	1200800000	HDC-C-HE-BM2.5AG	1201400000
100	HDC-C-HE-SM4.0AG	1200900000	HDC-C-HE-BM4.0AG	1201500000
100	HDC-C-HE-SM0.5AU	1651420000	HDC-C-HE-BM0.5AU	1651470000
100	HDC-C-HE-SM0.75-1AU	1651430000	HDC-C-HE-BM0.75-1AU	1651480000
100	HDC-C-HE-SM1.5AU	1651440000	HDC-C-HE-BM1.5AU	1651490000
100	HDC-C-HE-SM2.5AU	1651450000	HDC-C-HE-BM2.5AU	1651500000
100	HDC-C-HE-SM4.0AU	1651460000	HDC-C-HE-BM4.0AU	1651510000

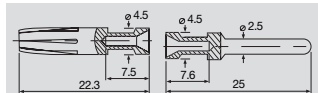

Single contacts	AWG No.
Conductor mm ²	
0.50	20
0.75-1.00	18
1.50	16
2.50	14
4.00	12

Tools



Tool	Order No.
Crimping tool CTX CM 1.6/2.5	9018490000
Contact removal tool Removal Tool HE	1866750000

Selection of Housings RockStar® IP65
Size 8



Hood

Hood, Cable Entry sideways



a	Version	Cover	b (mm)	Designation	Order No.
M 25	with thread		61	HDC 24B TSBU 1M25G	1787760000
M 32	with thread		61	HDC 24B TSBU 1M32G	1787750000
M 25	with thread		76	HDC 64D TSBU 1M25G	1786780000
M 32	with thread		76	HDC 64D TSBU 1M32G	1786770000

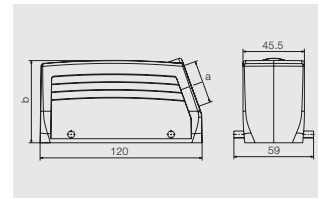

Hood, Cable Entry at top



a	Version	Cover	b (mm)	Designation	Order No.
M 25	with thread		61	HDC 24B TOBU 1M25G	1787820000
M 32	with thread		61	HDC 24B TOBU 1M32G	1787810000
M 32	with thread		76	HDC 64D TOBU 1M32G	1786830000

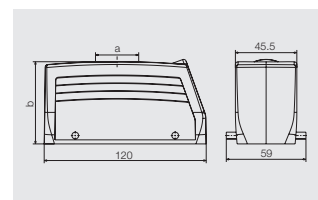

Cover

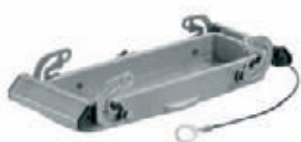

Version	Designation	Order No.
for hoods	HDC 24B DMDQ 2QB	1665640000

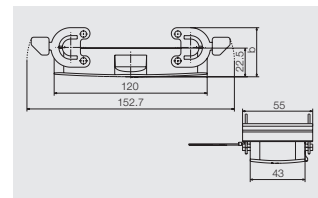

Base

Bulkhead housing



Version	Cover	b (mm)	Designation	Order No.
		29.3	HDC 24B ABU	1212400000

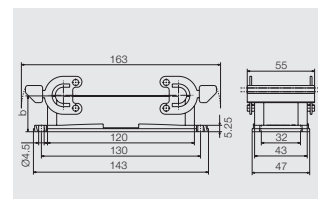

Base housing



a	Version	Cover	b (mm)	Designation	Order No.
M 25	with thread		64	HDC 24B SBU 2M25G	1787870000
M 25	with thread		84	HDC 64D SBU 2M25G	1786890000
M 32	with thread		84	HDC 64D SBU 2M32G	1786880000

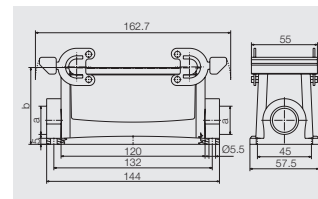

Coupling hood



a	Version	Cover	b (mm)	Designation	Order No.
M 25	with thread		65	HDC 24B KBU 1M25G	1787920000
M 32	with thread		79	HDC 64D KBU 1M32G	1786960000

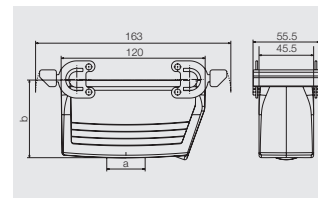

Cover



Version	Designation	Order No.
for bases	HDC 24B DODQ 4BO	1665630000

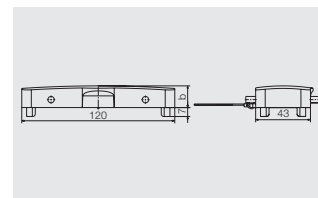

HE series - the universal connectors

500 V, 16 A, Size 10

32 + ⊕

Inserts



Tension clamp connection



Insert	Designation	Order No.
Male	HDC HE 16 MT	1745840000
Female	HDC HE 16 FT	1745780000
Male	HDC HE 16 MT 17-32	1745860000
Female	HDC HE 16 FT 17-32	1745800000

Screw connection

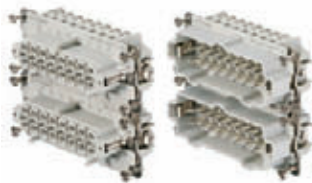

Insert	Designation	Order No.
Male	HDC HE 16 MS	1207500000
Female	HDC HE 16 FS	1207700000
Male	HDC HE 16 MS 17-32	1215700000
Female	HDC HE 16 FS 17-32	1216100000

Push In connection

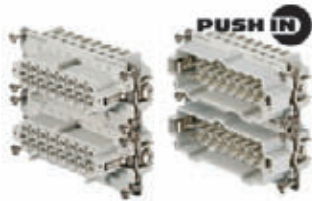

Insert	Designation	Order No.
Male	HDC HE 16 MP	1873570000
Female	HDC HE 16 FP	1873560000
Male	HDC HE 16 MP 17-32	1875800000
Female	HDC HE 16 FP 17-32	1875740000

Crimp connection



Insert	Designation	Order No.
Male	HDC HE 16 MC	1207900000
Female	HDC HE 16 FC	1208000000
Male	HDC HE 16 MC 17-32	1216500000
Female	HDC HE 16 FC 17-32	1216700000

Dimensions

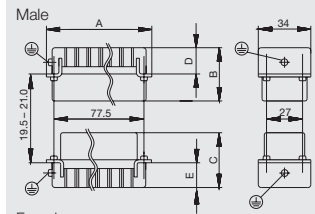

A (mm)	B (mm)	C (mm)	D (mm)	E (mm)
83.30	33.80	33.20	19.10	16.50

Arrangement of contacts

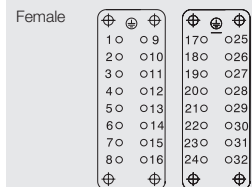
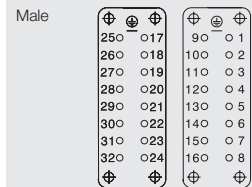

Mounting cut-out

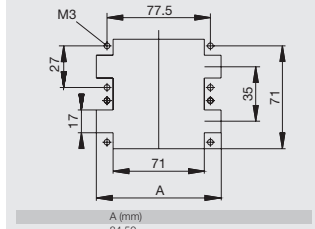

Accessories

Crimp contacts

Surface silver



Surface gold



Qty.	Male	Order No.	Female	Order No.
100	HDC-C-HE-SM0.5AG	1200500000	HDC-C-HE-BM0.5AG	1201100000
100	HDC-C-HE-SM0.75-1AG	1200600000	HDC-C-HE-BM0.75-1AG	1201200000
100	HDC-C-HE-SM1.5AG	1200700000	HDC-C-HE-BM1.5AG	1201300000
100	HDC-C-HE-SM2.5AG	1200800000	HDC-C-HE-BM2.5AG	1201400000
100	HDC-C-HE-SM4.0AG	1200900000	HDC-C-HE-BM4.0AG	1201500000
100	HDC-C-HE-SM0.5AU	1651420000	HDC-C-HE-BM0.5AU	1651470000
100	HDC-C-HE-SM0.75-1AU	1651430000	HDC-C-HE-BM0.75-1AU	1651480000
100	HDC-C-HE-SM1.5AU	1651440000	HDC-C-HE-BM1.5AU	1651490000
100	HDC-C-HE-SM2.5AU	1651450000	HDC-C-HE-BM2.5AU	1651500000
100	HDC-C-HE-SM4.0AU	1651460000	HDC-C-HE-BM4.0AU	1651510000

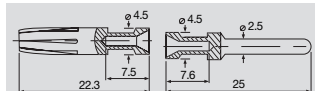

Conductor mm ²	AWG No.
0.50	20
0.75-1.00	18
1.50	16
2.50	14
4.00	12

Tools



Tool	Order No.
Crimping tool CTX CM 1.6/2.5	9018490000
Contact removal tool Removal Tool HE	1866750000

Selection of Housings RockStar® IP65
Size 10



Hood

Hood, Cable Entry sideways



a	Version	Cover	b (mm)	Designation	Order No.
M 32	with thread		79	HDC 32B TSLU 1M32G	1788420000

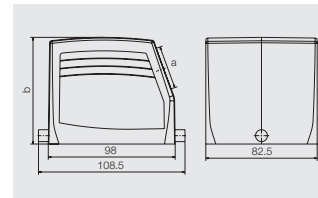

Base

Bulkhead housing



Version	Cover	b (mm)	Designation	Order No.
	with cover	55	HDC 32B ADLU	1219800000
		38	HDC 32B ALU	1219500000

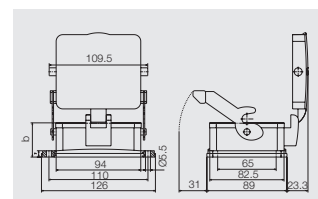

Base housing



a	Version	Cover	b (mm)	Designation	Order No.
M 32	with thread	with cover	96	HDC 32B SDLU 2M32G	1788490000
M 32	with thread		79	HDC 32B SLU 2M32G	1788470000

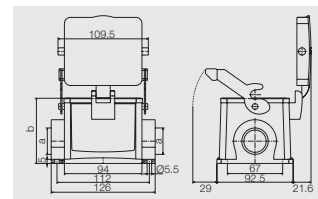

Coupling hood



a	Version	Cover	b (mm)	Designation	Order No.
M 32	with thread		83	HDC 32B KLU 1M32G	1788500000

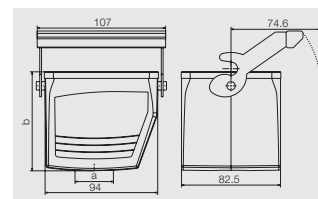

HE series - the universal connectors

500 V, 16 A, Size 12

48 + ⊕

Inserts



Tension clamp connection

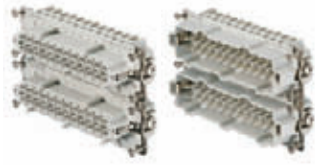

Insert	Designation	Order No.
Male	HDC HE 24 MT	1745850000
Female	HDC HE 24 FT	1745790000
Male	HDC HE 24 MT 25-48	1745870000
Female	HDC HE 24 FT 25-48	1745810000

Screw connection



Insert	Designation	Order No.
Male	HDC HE 24 MS	1211100000
Female	HDC HE 24 FS	1211300000
Male	HDC HE 24 MS 25-48	1220800000
Female	HDC HE 24 FS 25-48	1221200000

Push In connection

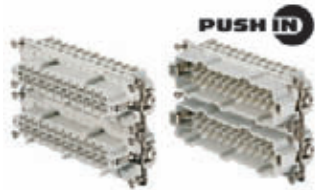

Insert	Designation	Order No.
Male	HDC HE 24 MP	1873590000
Female	HDC HE 24 FP	1873580000
Male	HDC HE 24 MP 25-48	1875890000
Female	HDC HE 24 FP 25-48	1875850000

Crimp connection



Insert	Designation	Order No.
Male	HDC HE 24 MC	1211500000
Female	HDC HE 24 FC	1211600000
Male	HDC HE 24 MC 25-48	1226400000
Female	HDC HE 24 FC 25-48	1226600000

Dimensions

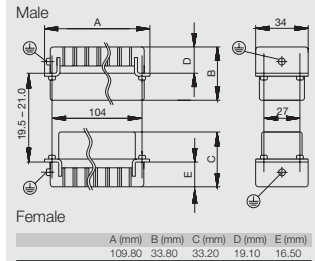

Arrangement of contacts

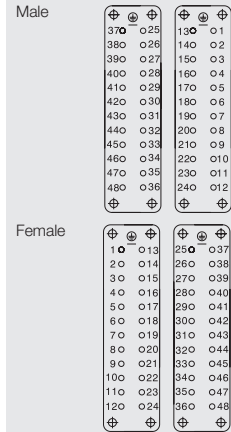

Mounting cut-out

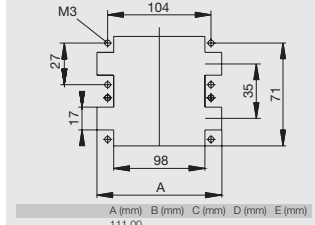

Accessories

Crimp contacts

Surface silver



Surface gold



Qty.	Male	Order No.	Female	Order No.
100	HDC-C-HE-SM0.5AG	1200500000	HDC-C-HE-BM0.5AG	1201100000
100	HDC-C-HE-SM0.75-1AG	1200600000	HDC-C-HE-BM0.75-1AG	1201200000
100	HDC-C-HE-SM1.5AG	1200700000	HDC-C-HE-BM1.5AG	1201300000
100	HDC-C-HE-SM2.5AG	1200800000	HDC-C-HE-BM2.5AG	1201400000
100	HDC-C-HE-SM4.0AG	1200900000	HDC-C-HE-BM4.0AG	1201500000
100	HDC-C-HE-SM0.5AU	1651420000	HDC-C-HE-BM0.5AU	1651470000
100	HDC-C-HE-SM0.75-1AU	1651430000	HDC-C-HE-BM0.75-1AU	1651480000
100	HDC-C-HE-SM1.5AU	1651440000	HDC-C-HE-BM1.5AU	1651490000
100	HDC-C-HE-SM2.5AU	1651450000	HDC-C-HE-BM2.5AU	1651500000
100	HDC-C-HE-SM4.0AU	1651460000	HDC-C-HE-BM4.0AU	1651510000

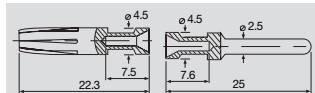

Single contacts

Conductor mm ²	AWG No.
0.50	20
0.75-1.00	18
1.50	16
2.50	14
4.00	12

Tools



Tool	Order No.
Crimping tool CTX CM 1.6/2.5	9018490000
Contact removal tool Removal Tool HE	1866750000

Selection of Housings RockStar® IP65
Size 12



Hood

Hood, Cable Entry sideways



a	Version	Cover	b (mm)	Designation	Order No.
M 32	with thread		94	HDC 48B TSLU 1M32G	1788320000
M 40	with thread		94	HDC 48B TSLU 1M40G	1788310000
M 50	with thread		94	HDC 48B TSLU 1M50G	1788300000

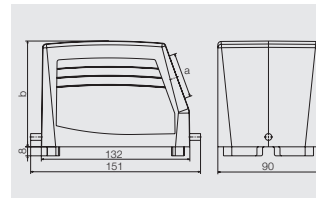

Hood, Cable Entry at top



a	Version	Cover	b (mm)	Designation	Order No.
M 32	with thread		94	HDC 48B TOLU 1M32G	1788350000
M 50	with thread		94	HDC 48B TOLU 1M50G	1788330000

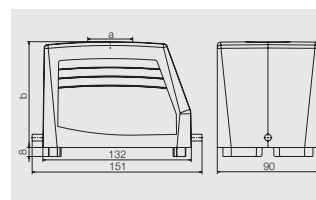

Base

Bulkhead housing



Version	Cover	b (mm)	Designation	Order No.
	with cover	62	HDC 48B ADLU	1222900000

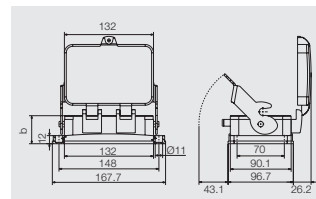

Base housing

a	Version	Cover	b (mm)	Designation	Order No.
M 32	with thread	with cover	120	HDC 48B SDLU 2M32G	1788390000
M 32	with thread		100	HDC 48B SLU 2M32G	1788370000
M 40	with thread		100	HDC 48B SLU 2M40G	1788360000

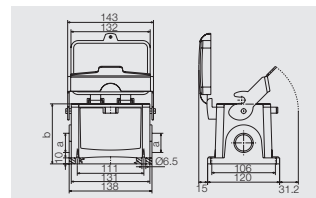

HEE series – high contact density

The HEE series has a high contact density and its design is based on the proven HE inserts.

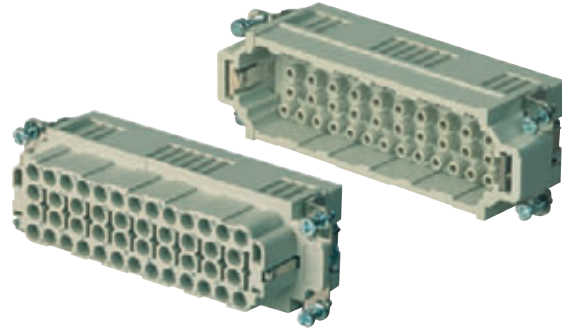

Technical data

Standards / approvals	
Standards	DIN EN 61984 DIN EN 60664-1
Approvals	UL/CSA
Inserts	
No. of poles	10, 18, 32, 46 (+PE)
Rated voltage	500 V
Rated voltage to UL/CSA	600 V
Rated current	16 A
Rated impulse withstand voltage	6 kV
Pollution severity	3
Insulation resistance	$\geq 10^{10} \Omega$
Material	Glass-fibre reinforced PC (in UL list and approved for railway applications)
Temperature range	-40 °C ... +125 °C
Flammability to UL 94	V-0
Mechanical service life	
- Plugging cycles Ag - Surface	≥ 500
- Plugging cycles Au - Surface	≥ 500
Contact resistance	
- Crimp connection	$\leq 4 \text{ m}\Omega$
Contacts / Material	
Sockets and plug-in contact	Copper alloy
Surface	Passivated silver, or 0.8 μm gold on 2 μm nickel
Crimp connection	
- Flexible conductor connection	0.5 - 4 mm ² (AWG 20 ... 12)
- Stripping length	7.5 mm
Clamping torque	
- Screw connection	
SD blades	
- Screw connection	
- Push In	
- Tension clamp connection	
PE connection	
- Clamping range	0.5 ... 4 mm ²
- solid / stranded	0.5 ... 4 mm ² / 0.5 ... 4 mm ²
- flexible / flexible with wire end ferrule, DIN 46228 pt. 1	0.5 ... 4 mm ² / 0.5 ... 4 mm ²
- AWG conductor	AWG 20 .. 12
- Stripping length	10 mm
- Clamping torque	1.2 ... 1.5 Nm
- Blade dimensions	SD 0.8 x 4 mm or PZ 1

Note: Switch off power supply before handling plug-in connectors.

If crimped with a 4 mm² conductor, the current rating is:

For HEE 10 = 31 A, for HEE 18 = 28 A, for HEE 32 for 46 pole = 25 A

Derating curves

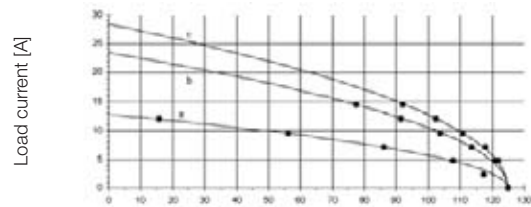

HEE 10-pole Ambient temperature [°C]

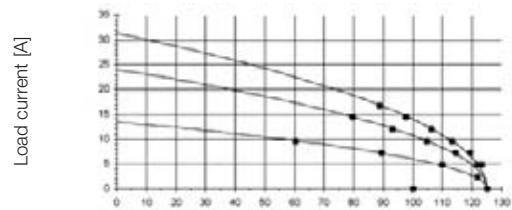

HEE 18-pole Ambient temperature [°C]

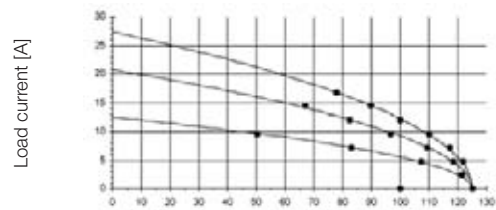



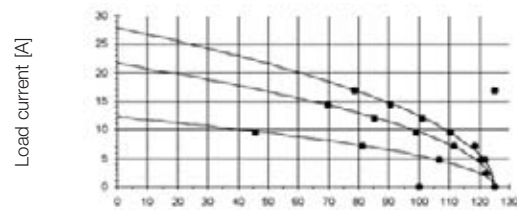





HEE 32-pole Ambient temperature [°C]



HEE 46-pole Ambient temperature [°C]

Curve a: 0.5 mm² conductor
Curve b: 2.5 mm² conductor
Curve c: 4.0 mm² conductor

Overview

		Rated voltage	Rated current	No. of poles	Tension clamp connection	Screw conn. with wire guard spring	Crimp connection	Push In	Axial screw connection	Page
		500 V	16 A	10 + ⊕			•			B.32
		500 V	16 A	18 + ⊕			•			B.34
		500 V	16 A	32 + ⊕			•			B.36
		500 V	16 A	46 + ⊕			•			B.38

HEE series - high contact density

500 V, 16 A, Size 3

10 + ⊕

Inserts



Crimp connection



Insert	Designation	Order No.
Male	HDC HEE 10 SCM	1826830000
Female	HDC HEE 10 BCM	1826840000

Dimensions

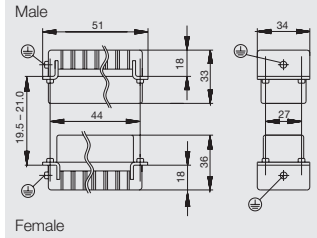

Arrangement of contacts

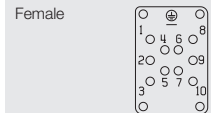
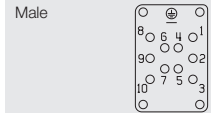

Mounting cut-out

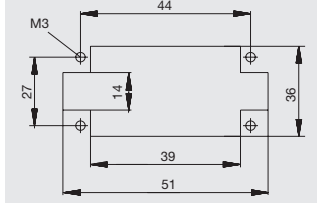

Accessories

Crimp contacts

Surface silver



Surface gold



Qty.	Male	Order No.	Female	Order No.
100	HDC-C-HE-SM0.5AG	1200500000	HDC-C-HE-BM0.5AG	1201100000
100	HDC-C-HE-SM0.75-1AG	1200600000	HDC-C-HE-BM0.75-1AG	1201200000
100	HDC-C-HE-SM1.5AG	1200700000	HDC-C-HE-BM1.5AG	1201300000
100	HDC-C-HE-SM2.5AG	1200800000	HDC-C-HE-BM2.5AG	1201400000
100	HDC-C-HE-SM4.0AG	1200900000	HDC-C-HE-BM4.0AG	1201500000
100	HDC-C-HE-SM0.5AU	1651420000	HDC-C-HE-BM0.5AU	1651470000
100	HDC-C-HE-SM0.75-1AU	1651430000	HDC-C-HE-BM0.75-1AU	1651480000
100	HDC-C-HE-SM1.5AU	1651440000	HDC-C-HE-BM1.5AU	1651490000
100	HDC-C-HE-SM2.5AU	1651450000	HDC-C-HE-BM2.5AU	1651500000
100	HDC-C-HE-SM4.0AU	1651460000	HDC-C-HE-BM4.0AU	1651510000

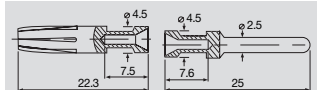

Single contacts

Conductor mm ²	AWG No.
0.50	20
0.75-1.00	18
1.50	16
2.50	14
4.00	12

Tools



Tool	Order No.
Crimping tool CTX CM 1.6/2.5	9018490000
Contact removal tool Removal Tool HE	1866750000

Selection of Housings RockStar® IP65
Size 3



Hood

Hood, Cable Entry sideways



a	Version	Cover	b (mm)	Designation	Order No.
M 20	with thread		52	HDC 06B TSLU 1M20G	1788100000
M 20	with thread		52	HDC 06B TSLU 1M20G	1805930000
M 25	with thread		52	HDC 06B TSLU 1M25G	1788090000
M 25	with thread		72	HDC 16D TSLU 1M25G	1787480000

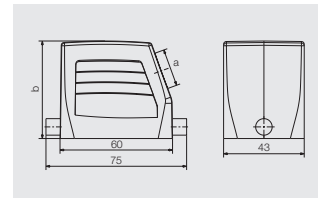

Hood, Cable Entry at top



a	Version	Cover	b (mm)	Designation	Order No.
M 20	with thread		52	HDC 06B TOLU 1M20G	1788120000
M 25	with thread		52	HDC 06B TOLU 1M25G	1788110000
M 25	with thread		72	HDC 16D TOLU 1M25G	1787500000
M 32	with thread		72	HDC 16D TOLU 1M32G	1787490000

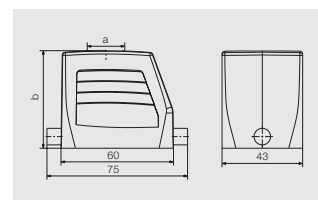

Cover



Version	Designation	Order No.
for hoods	HDC 06B DMDL 1LB	1665210000

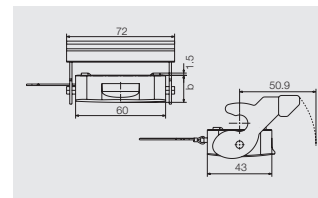

Base

Bulkhead housing



Version	Cover	b (mm)	Designation	Order No.
		29	HDC 06B ALU	1202100000
	with cover	47	HDC 06B ADLU	1202500000

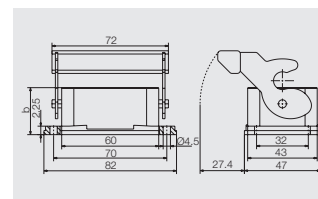

Base housing



a	Version	Cover	b (mm)	Designation	Order No.
M 20	with thread		54	HDC 06B SLU 2M20G	1788140000
M 20	with thread	with cover	72	HDC 06B SDLU 2M20G	1788170000
M 25	with thread		54	HDC 06B SLU 2M25G	1788130000
M 25	with thread	with cover	72	HDC 06B SDLU 2M25G	1788160000

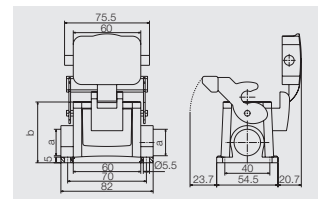

Cover



Version	Designation	Order No.
for bases	HDC 06B DODL 2BO	1665200000

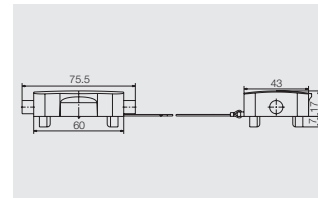

HEE series - high contact density

500 V, 16 A, Size 4

18 + ⊕

Inserts



Crimp connection



Insert	Designation	Order No.
Male	HDC HEE 18 SCM	1826810000
Female	HDC HEE 18 BCM	1826820000

Dimensions

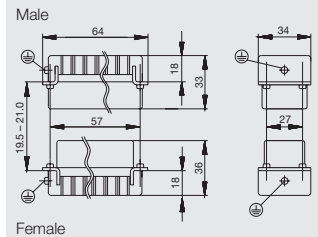

Arrangement of contacts

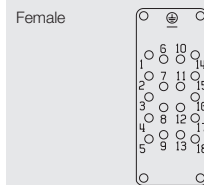
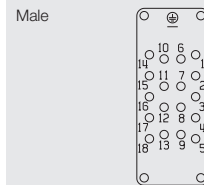

Mounting cut-out

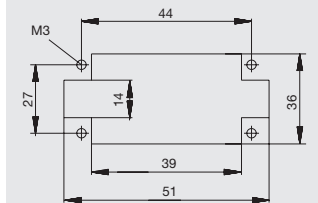

Accessories

Crimp contacts

Surface silver



Surface gold



Qty.	Male	Order No.	Female	Order No.
100	HDC-C-HE-SM0.5AG	1200500000	HDC-C-HE-BM0.5AG	1201100000
100	HDC-C-HE-SM0.75-1AG	1200600000	HDC-C-HE-BM0.75-1AG	1201200000
100	HDC-C-HE-SM1.5AG	1200700000	HDC-C-HE-BM1.5AG	1201300000
100	HDC-C-HE-SM2.5AG	1200800000	HDC-C-HE-BM2.5AG	1201400000
100	HDC-C-HE-SM4.0AG	1200900000	HDC-C-HE-BM4.0AG	1201500000
100	HDC-C-HE-SM0.5AU	1651420000	HDC-C-HE-BM0.5AU	1651470000
100	HDC-C-HE-SM0.75-1AU	1651430000	HDC-C-HE-BM0.75-1AU	1651480000
100	HDC-C-HE-SM1.5AU	1651440000	HDC-C-HE-BM1.5AU	1651490000
100	HDC-C-HE-SM2.5AU	1651450000	HDC-C-HE-BM2.5AU	1651500000
100	HDC-C-HE-SM4.0AU	1651460000	HDC-C-HE-BM4.0AU	1651510000

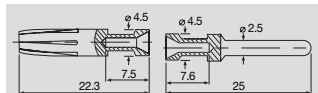

Single contacts

Conductor mm ²	AWG No.
0.50	20
0.75-1.00	18
1.50	16
2.50	14
4.00	12

Tools



Crimping tool	Order No.
CTX CM 1.6/2.5	9018490000
Contact removal tool	Order No.
Removal Tool HE	1866750000

Selection of Housings RockStar® IP65
Size 4



Hood

Hood, Cable Entry sideways



a	Version	Cover	b (mm)	Designation	Order No.
M 20	with thread		52	HDC 10B TSBU 1M20G	1787560000
M 25	with thread		52	HDC 10B TSBU 1M25G	1787550000
M 25	with thread		72	HDC 24D TSBU 1M25G	1787240000
M 32	with thread		72	HDC 24D TSBU 1M32G	1787230000

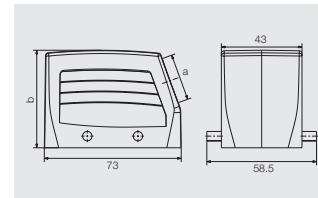

Hood, Cable Entry at top



a	Version	Cover	b (mm)	Designation	Order No.
M 20	with thread		52	HDC 10B TOBU 1M20G	1787600000
M 25	with thread		52	HDC 10B TOBU 1M25G	1787590000
M 25	with thread		72	HDC 24D TOBU 1M25G	1787300000
M 32	with thread		72	HDC 24D TOBU 1M32G	1787290000

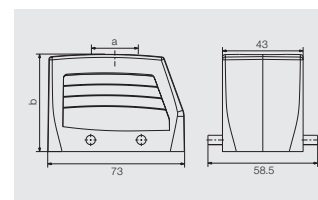

Cover



Version	Designation	Order No.
for hoods	HDC 10B DMDQ 2QB	1665240000

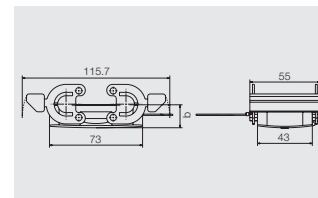

Base

Bulkhead housing



Version	Cover	b (mm)	Designation	Order No.
		29.3	HDC 10B ABU	1205000000

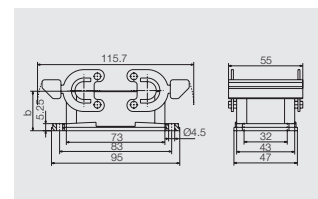

Base housing



a	Version	Cover	b (mm)	Designation	Order No.
M 20	with thread		57	HDC 10B SBU 2M20G	1787640000
M 25	with thread		57	HDC 10B SBU 2M25G	1787630000
M 25	with thread		74	HDC 24D SBU 2M25G	1787350000
M 32	with thread		74	HDC 24D SBU 2M32G	1787360000

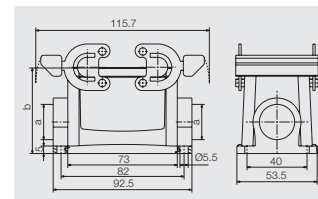

Coupling hood



a	Version	Cover	b (mm)	Designation	Order No.
M 20	with thread		55	HDC 10B KBU 1M20G	1787720000

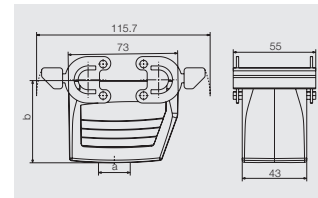

Cover



Version	Designation	Order No.
for bases	HDC 10B DODQ 4BO	1665230000

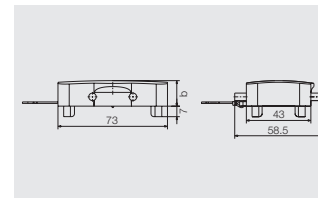

HEE series - high contact density

500 V, 16 A, Size 6

32 + ⊕

Inserts



Crimp connection



Insert	Designation	Order No.
Male	HDC HEE 32 SCM	1826790000
Female	HDC HEE 32 BCM	1826800000

Dimensions

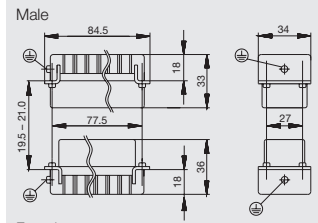

Arrangement of contacts

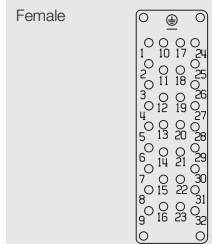
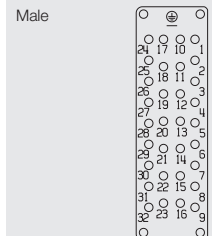

Mounting cut-out

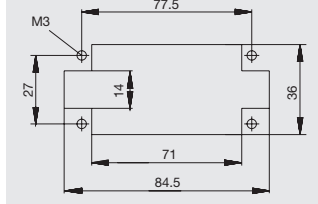

Accessories

Crimp contacts

Surface silver



Surface gold



Qty.	Male	Order No.	Female	Order No.
100	HDC-C-HE-SM0.5AG	1200500000	HDC-C-HE-BM0.5AG	1201100000
100	HDC-C-HE-SM0.75-1AG	1200600000	HDC-C-HE-BM0.75-1AG	1201200000
100	HDC-C-HE-SM1.5AG	1200700000	HDC-C-HE-BM1.5AG	1201300000
100	HDC-C-HE-SM2.5AG	1200800000	HDC-C-HE-BM2.5AG	1201400000
100	HDC-C-HE-SM4.0AG	1200900000	HDC-C-HE-BM4.0AG	1201500000
100	HDC-C-HE-SM0.5AU	1651420000	HDC-C-HE-BM0.5AU	1651470000
100	HDC-C-HE-SM0.75-1AU	1651430000	HDC-C-HE-BM0.75-1AU	1651480000
100	HDC-C-HE-SM1.5AU	1651440000	HDC-C-HE-BM1.5AU	1651490000
100	HDC-C-HE-SM2.5AU	1651450000	HDC-C-HE-BM2.5AU	1651500000
100	HDC-C-HE-SM4.0AU	1651460000	HDC-C-HE-BM4.0AU	1651510000

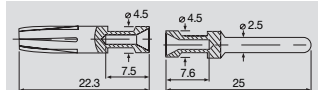

Single contacts

Conductor mm ²	AWG No.
0.50	20
0.75-1.00	18
1.50	16
2.50	14
4.00	12

Tools



Crimping tool	Order No.
CTX CM 1.6/2.5	9018490000
Contact removal tool	Order No.
Removal Tool HE	1866750000

Selection of Housings RockStar® IP65
Size 6



Hood

Hood, Cable Entry sideways



a	Version	Cover	b (mm)	Designation	Order No.
M 25	with thread		61	HDC 16B TSBU 1M25G	1788180000
M 25	with thread		76	HDC 40D TSBU 1M25G	1787010000
M 32	with thread		76	HDC 40D TSBU 1M32G	1787000000

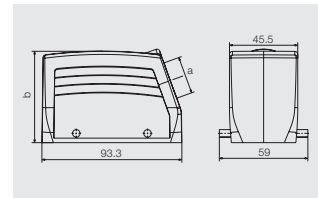

Hood, Cable Entry at top



a	Version	Cover	b (mm)	Designation	Order No.
M 25	with thread		61	HDC 16B TOBU 1M25G	1788210000
M 25	with thread		76	HDC 40D TOBU 1M25G	1787070000
M 32	with thread		76	HDC 40D TOBU 1M32G	1787060000

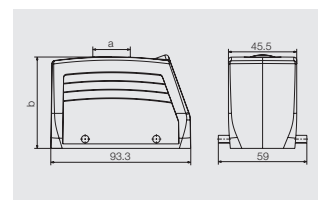

Cover

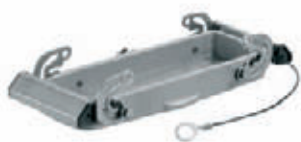

Version	Designation	Order No.
for hoods	HDC 16B DMDQ 2QB	1665270000

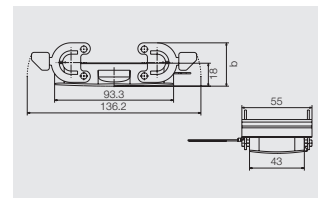

Base

Bulkhead housing



Version	Cover	b (mm)	Designation	Order No.
		29	HDC 16B ABU	1208600000

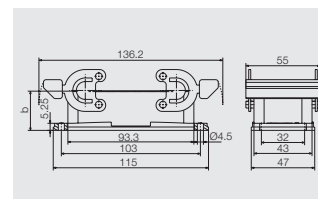

Base housing



a	Version	Cover	b (mm)	Designation	Order No.
M 25	with thread		64	HDC 16B SBU 2M25G	1788240000
M 25	with thread		84	HDC 40D SBU 2M25G	1787120000
M 32	with thread		84	HDC 40D SBU 2M32G	1787110000

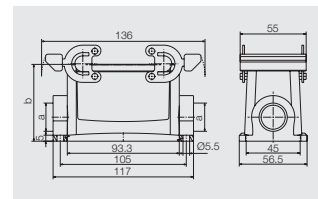

Coupling hood



a	Version	Cover	b (mm)	Designation	Order No.
M 25	with thread		79	HDC 40D KBU 1M25G	1787200000
M 32	with thread		79	HDC 40D KBU 1M32G	1787190000

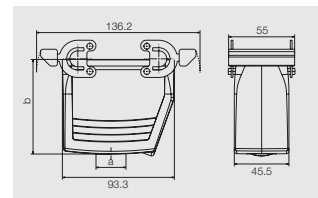

Cover



Version	Designation	Order No.
for bases	HDC 16B DODQ 4BO	1665260000

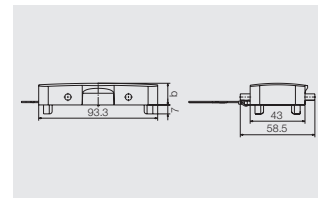

HEE series - high contact density

500 V, 16 A, Size 8

46 + ⊕

Inserts



Crimp connection



Insert	Designation	Order No.
Male	HDC HEE 46 SCM	1826770000
Female	HDC HEE 46 BCM	1826780000

Dimensions

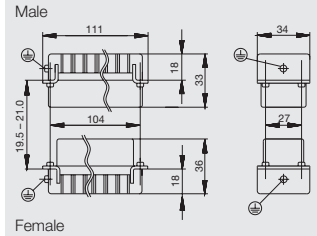

Arrangement of contacts

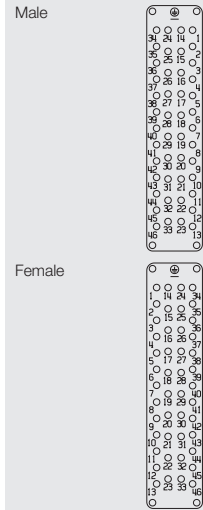

Mounting cut-out

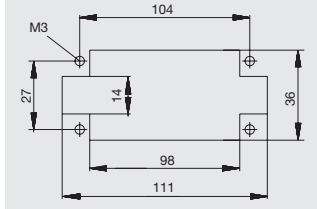

Accessories

Crimp contacts

Surface silver



Surface gold



Qty.	Male	Order No.	Female	Order No.
100	HDC-C-HE-SM0.5AG	1200500000	HDC-C-HE-BM0.5AG	1201100000
100	HDC-C-HE-SM0.75-1AG	1200600000	HDC-C-HE-BM0.75-1AG	1201200000
100	HDC-C-HE-SM1.5AG	1200700000	HDC-C-HE-BM1.5AG	1201300000
100	HDC-C-HE-SM2.5AG	1200800000	HDC-C-HE-BM2.5AG	1201400000
100	HDC-C-HE-SM4.0AG	1200900000	HDC-C-HE-BM4.0AG	1201500000
100	HDC-C-HE-SM0.5AU	1651420000	HDC-C-HE-BM0.5AU	1651470000
100	HDC-C-HE-SM0.75-1AU	1651430000	HDC-C-HE-BM0.75-1AU	1651480000
100	HDC-C-HE-SM1.5AU	1651440000	HDC-C-HE-BM1.5AU	1651490000
100	HDC-C-HE-SM2.5AU	1651450000	HDC-C-HE-BM2.5AU	1651500000
100	HDC-C-HE-SM4.0AU	1651460000	HDC-C-HE-BM4.0AU	1651510000

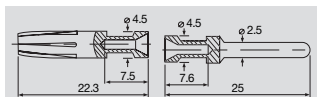

Single contacts

Conductor mm ²	AWG No.
0.50	20
0.75-1.00	18
1.50	16
2.50	14
4.00	12

Tools



Tool	Order No.
Crimping tool CTX CM 1.6/2.5	9018490000
Contact removal tool Removal Tool HE	1866750000

Selection of Housings RockStar® IP65
Size 8



Hood

Hood, Cable Entry sideways



a	Version	Cover	b (mm)	Designation	Order No.
M 25	with thread		61	HDC 24B TSBU 1M25G	1787760000
M 32	with thread		61	HDC 24B TSBU 1M32G	1787750000
M 25	with thread		76	HDC 64D TSBU 1M25G	1786780000
M 32	with thread		76	HDC 64D TSBU 1M32G	1786770000

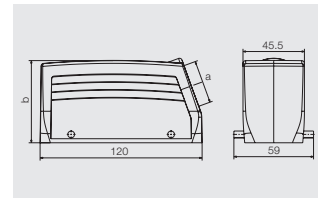

Hood, Cable Entry at top



a	Version	Cover	b (mm)	Designation	Order No.
M 25	with thread		61	HDC 24B TOBU 1M25G	1787820000
M 32	with thread		61	HDC 24B TOBU 1M32G	1787810000
M 32	with thread		76	HDC 64D TOBU 1M32G	1786830000

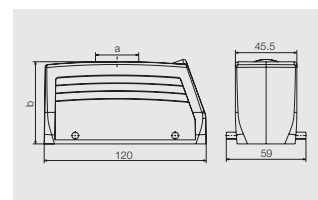

Cover

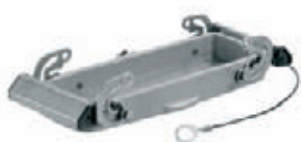

Version	Designation	Order No.
for hoods	HDC 24B DMDQ 2QB	1665640000

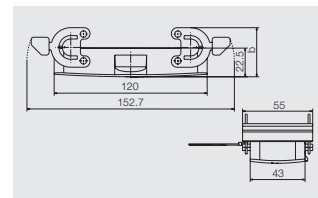

Base

Bulkhead housing



Version	Cover	b (mm)	Designation	Order No.
		29.3	HDC 24B ABU	1212400000

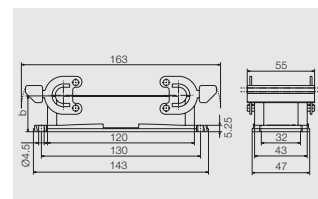

Base housing



a	Version	Cover	b (mm)	Designation	Order No.
M 25	with thread		64	HDC 24B SBU 2M25G	1787870000
M 25	with thread		84	HDC 64D SBU 2M25G	1786890000
M 32	with thread		84	HDC 64D SBU 2M32G	1786880000

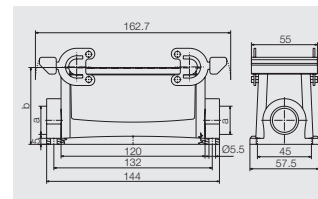

Coupling hood



a	Version	Cover	b (mm)	Designation	Order No.
M 25	with thread		65	HDC 24B KBU 1M25G	1787920000
M 32	with thread		79	HDC 64D KBU 1M32G	1786960000

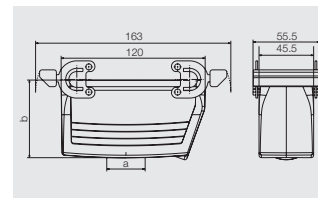

Cover



Version	Designation	Order No.
for bases	HDC 24B DODQ 4BO	1665630000

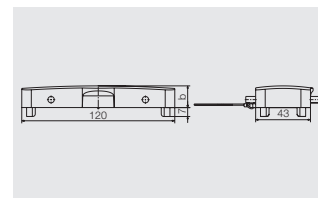

HD series – the flexible connectors

The HD series has a high contact density and is therefore particularly suitable for signal processing. The HD insert can be fitted with turned crimp contacts or fibre optic contacts – impressive flexibility.



Technical data

Standards / approvals	
Standards	DIN EN 61984 DIN EN 60664-1
Approvals	UL/CSA
Inserts	
No. of poles	7, 15, 16, 20, 25, 40, 50, 64, 80, 124 (+PE), 8
Rated voltage	250 V
Rated voltage to UL/CSA	600 V
Rated current	10 A
Rated impulse withstand voltage	4 KV
Pollution severity	3
Insulation resistance	$\geq 10^{10} \Omega$
Material	Glass-fibre reinforced PC (in UL list and approved for railway applications)
Temperature range	-40 °C ... +125 °C
Flammability to UL 94	V-0
Mechanical service life	
- Plugging cycles Ag - Surface	≥ 500
- Plugging cycles Au - Surface	≥ 500
Contact resistance	
Crimp connection	$\leq 4 \text{ m}\Omega$
Contacts / Material	
Sockets and plug-in contact	Copper alloy
Surface	Passivated silver, or 0.8 μm gold on 2 μm nickel
Crimp connection	
- Flexible conductor connection	0.14 - 2.5 mm ² (AWG 26 ... 14)
- Stripping length	8.0 mm
Clamping torque	
- Screw connection	
SD blades	
- Screw connection	
- Push In	
- Tension clamp connection	
PE connection	
- Clamping range	0.5 ... 2,5 mm ²
- solid / stranded	0.5 ... 2,5 mm ² / 0.5 ... 2,5 mm ²
- flexible / flexible with wire end ferrule, DIN 46228 pt. 1	0.5 ... 2,5 mm ² / 0.5 ... 2,5 mm ²
- AWG conductor	AWG 20 ... 14
- Stripping length	10 mm
- Clamping torque	1.2 ... 1.5 Nm
- Blade dimensions	SD 0.8 x 4 mm or PZ 1

Note: Technical data: Earthing via screw connection for inserts with ≥ 15 poles Switch off power supply before handling plug-in connectors.

When using metal housings together with the HD 7 and HD 8 inserts, the voltage rating must be limited to 42 V. The HD 8 has no earthing terminal.

Derating curves

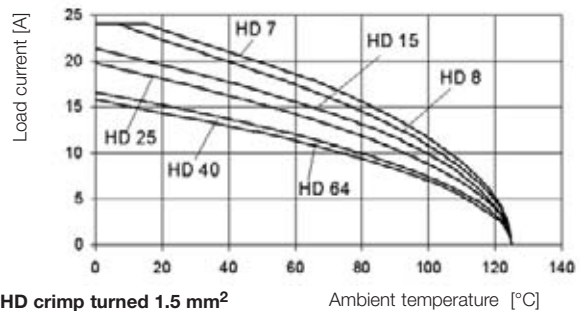



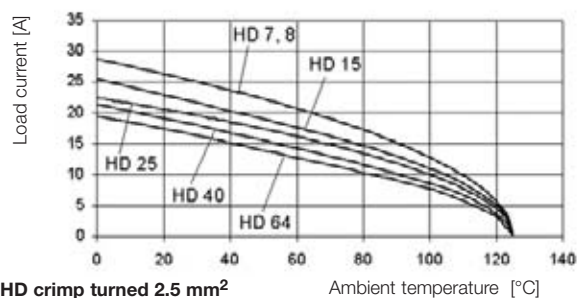











HD crimp turned 1.5 mm² Ambient temperature [°C]



HD crimp turned 2.5 mm² Ambient temperature [°C]

Overview

		Rated voltage	Rated current	No. of poles	Tension clamp connection	Screw conn. with wire guard spring	Crimp connection	Push In	Axial screw connection	Page
		250 V	10 A	7 + ⊕			•			B.42
		250 V	10 A	8			•			B.44
		250 V	10 A	15 + ⊕			•			B.46
		250 V	10 A	16 + ⊕			•			B.48
		250 V	10 A	24 + ⊕			•			B.50
		250 V	10 A	25 + ⊕			•			B.52
		250 V	10 A	40 + ⊕			•			B.54
		250 V	10 A	50 + ⊕			•			B.56
		250 V	10 A	64 + ⊕			•			B.58
		250 V	10 A	80 + ⊕			•			B.60
		250 V	10 A	128 + ⊕			•			B.62

HD series - the flexible connectors

250 V, 10 A, Size 1

7 + ⊕

Inserts



Crimp connection



Insert	Designation	Order No.
Male	HDC HD 7 MC	1650570000
Female	HDC HD 7 FC	1650580000

Note Reduce the voltage to 42V when using a metal housing

Dimensions

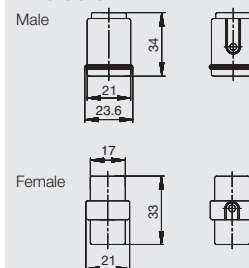

Arrangement of contacts

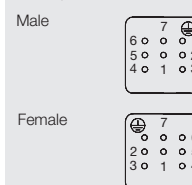

Accessories

Crimp contacts

Surface silver



Surface gold



Qty.	Male	Order No.	Female	Order No.
100	HDC-C-HD-SM0.14-0.37AG	1651520000	HDC-C-HD-BM0.14-0.37AG	1651570000
100	HDC-C-HD-SM0.5AG	1651530000	HDC-C-HD-BM0.5AG	1651580000
100	HDC-C-HD-SM0.75-1AG	1601750000	HDC-C-HD-BM0.75-1AG	1601760000
100	HDC-C-HD-SM1.5AG	1651550000	HDC-C-HD-BM1.5AG	1651600000
100	HDC-C-HD-SM2.5AG	1651560000	HDC-C-HD-BM2.5AG	1651610000
100	HDC-C-HD-SM0.14-0.37AU	1651620000	HDC-C-HD-BM0.14-0.37AU	1651670000
100	HDC-C-HD-SM0.5AU	1651630000	HDC-C-HD-BM0.5AU	1651680000
100	HDC-C-HD-SM0.75-1AU	1651640000	HDC-C-HD-BM0.75-1AU	1651690000
100	HDC-C-HD-SM1.5AU	1651650000	HDC-C-HD-BM1.5AU	1651700000
100	HDC-C-HD-SM2.5AU	1651660000	HDC-C-HD-BM2.5AU	1651710000

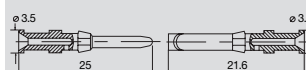

Single contacts	Conductor mm ²	AWG No.
0.14 - 0.37	22	
0.50	20	
0.75 - 1.00	18	
1.50	16	
2.50	14	

Tools



Crimping tool	Order No.
CTX CM 1.6/2.5	9018490000

Contact removal tool	Order No.
Removal Tool HD	1866730000

**Selection of Housings RockStar® IP65
Size 1**



Hood

material: Diecast aluminium

Hood, Cable Entry sideways



a	Version	Cover	b (mm)	Designation	Order No.
M 20	with thread		49,2	HDC 04A TWLU 1M20G	1788810000

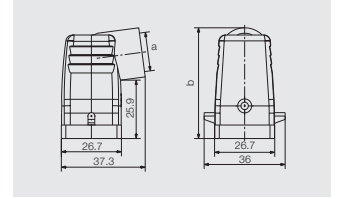

Hood, Cable Entry at top



a	Version	Cover	b (mm)	Designation	Order No.
M 20	with thread		50	HDC 04A TOLU 1M20G	1788820000

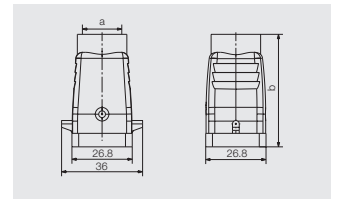

Base

Bulkhead housing



Version	Cover	b (mm)	Designation	Order No.
		23	HDC 04A ALU	1497600000

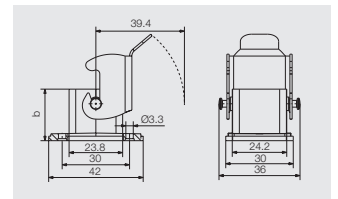

Base housing



a	Version	Cover	b (mm)	Designation	Order No.
M 20	with thread		25,8	HDC 04A SLU 1M20G	1788830000

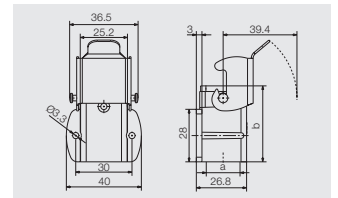

Coupling hood



a	Version	Cover	b (mm)	Designation	Order No.
M 20	with thread		53,5	HDC 04A KOLU 1M20G	1788840000

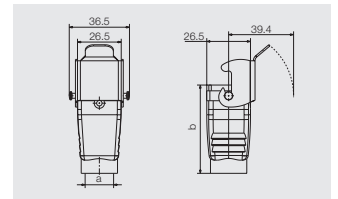

Screw Mounting Housing



a	Version	Cover	b (mm)	Designation	Order No.
M 20	with thread		54	HDC 04A ELU 1M20G	1900320000
PG 13,5	with thread		54	HDC 04A ELU 1PG13G	1900330000
PG 13,5	with thread		54	HDC 04A ELU 1PG13G EXI	1900350000

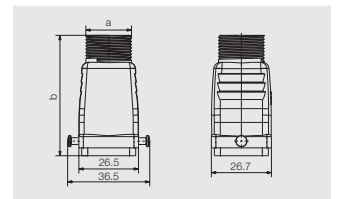

Cover



Version	Designation	Order No.
for female insert	HDC 04A DMDL 2BO	1665750000
for male insert	HDC 04A DODL 2BO	1665740000

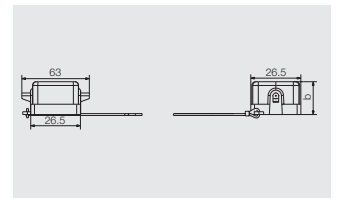

HD series - the flexible connectors

250 V, 10 A, Size 1

8

Inserts



Crimp connection



Insert	Designation	Order No.
Male	HDC HD 8 MC	1650590000
Female	HDC HD 8 FC	1650600000

Note Reduce the voltage to 42V when using a metal housing

Dimensions

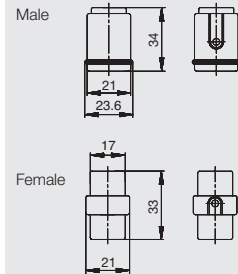

Arrangement of contacts

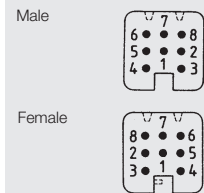

Accessories

Crimp contacts

Surface silver



Surface gold



Qty.	Male	Order No.	Female	Order No.
100	HDC-C-HD-SM0.14-0.37AG	1651520000	HDC-C-HD-BM0.14-0.37AG	1651570000
100	HDC-C-HD-SM0.5AG	1651530000	HDC-C-HD-BM0.5AG	1651580000
100	HDC-C-HD-SM0.75-1AG	1601750000	HDC-C-HD-BM0.75-1AG	1601760000
100	HDC-C-HD-SM1.5AG	1651550000	HDC-C-HD-BM1.5AG	1651600000
100	HDC-C-HD-SM2.5AG	1651560000	HDC-C-HD-BM2.5AG	1651610000
100	HDC-C-HD-SM0.14-0.37AU	1651620000	HDC-C-HD-BM0.14-0.37AU	1651670000
100	HDC-C-HD-SM0.5AU	1651630000	HDC-C-HD-BM0.5AU	1651680000
100	HDC-C-HD-SM0.75-1AU	1651640000	HDC-C-HD-BM0.75-1AU	1651690000
100	HDC-C-HD-SM1.5AU	1651650000	HDC-C-HD-BM1.5AU	1651700000
100	HDC-C-HD-SM2.5AU	1651660000	HDC-C-HD-BM2.5AU	1651710000

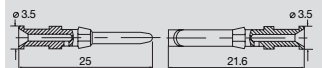

Single contacts

Conductor mm ²	AWG No.
0.14 - 0.37	22
0.50	20
0.75 - 1.00	18
1.50	16
2.50	14

Tools



Tool	Order No.
Crimping tool CTX CM 1.6/2.5	9018490000
Contact removal tool Removal Tool HD	1866730000

Selection of Housings RockStar® IP65
Size 1



Hood

material: Diecast aluminium

Hood, Cable Entry sideways



a	Version	Cover	b (mm)	Designation	Order No.
M 20	with thread		49,2	HDC 04A TWLU 1M20G	1788810000

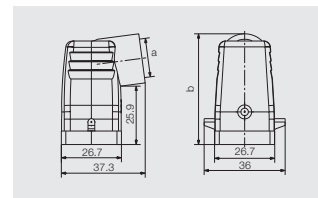

Hood, Cable Entry at top



a	Version	Cover	b (mm)	Designation	Order No.
M 20	with thread		50	HDC 04A TOLU 1M20G	1788820000

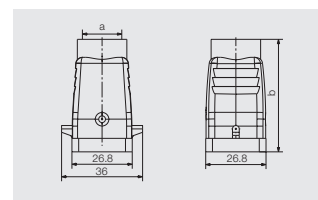

Base

Bulkhead housing



Version	Cover	b (mm)	Designation	Order No.
		23	HDC 04A ALU	1497600000

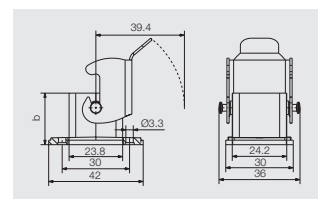

Base housing



a	Version	Cover	b (mm)	Designation	Order No.
M 20	with thread		25,8	HDC 04A SLU 1M20G	1788830000

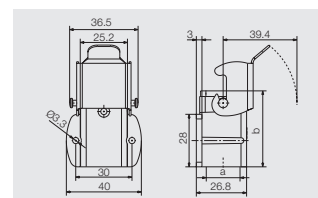

Coupling hood



a	Version	Cover	b (mm)	Designation	Order No.
M 20	with thread		53,5	HDC 04A KOLU 1M20G	1788840000

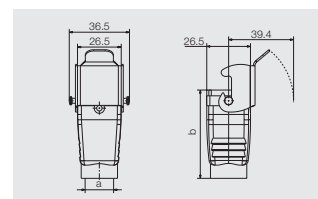

Screw Mounting Housing



a	Version	Cover	b (mm)	Designation	Order No.
M 20	with thread		54	HDC 04A ELU 1M20G	1900320000
PG 13,5	with thread		54	HDC 04A ELU 1PG13G	1900330000
PG 13,5	with thread		54	HDC 04A ELU 1PG13G EXI	1900350000

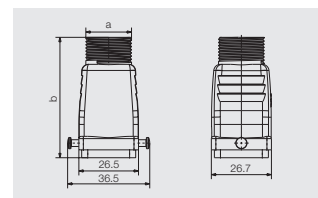

Cover



Version	Designation	Order No.
for female insert	HDC 04A DMDL 2BO	1665750000
for male insert	HDC 04A DODL 2BO	1665740000

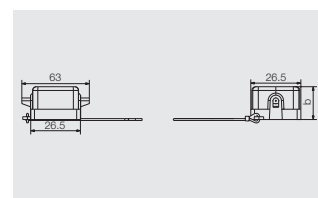

HD series - the flexible connectors

250 V, 10 A, Size 2

15 + ⊕

Inserts



Crimp connection



Insert	Designation	Order No.
Female	HDC HD 15 FC	1650660000
Male	HDC HD 15 MC	1650650000

Dimensions

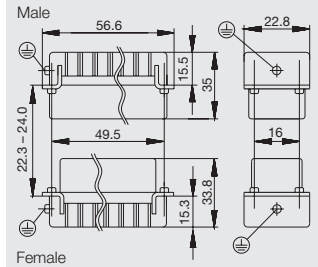

Arrangement of contacts

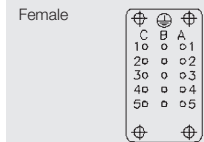
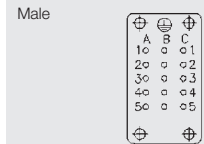

Mounting cut-out

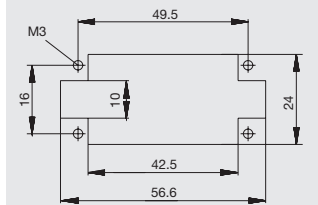

Accessories

Crimp contacts

Surface silver



Surface gold



Qty.	Male	Order No.	Female	Order No.
100	HDC-C-HD-SM0.14-0.37AG	1651520000	HDC-C-HD-BM0.14-0.37AG	1651570000
100	HDC-C-HD-SM0.5AG	1651530000	HDC-C-HD-BM0.5AG	1651580000
100	HDC-C-HD-SM0.75-1AG	1601750000	HDC-C-HD-BM0.75-1AG	1601760000
100	HDC-C-HD-SM1.5AG	1651550000	HDC-C-HD-BM1.5AG	1651600000
100	HDC-C-HD-SM2.5AG	1651560000	HDC-C-HD-BM2.5AG	1651610000
100	HDC-C-HD-SM0.14-0.37AU	1651620000	HDC-C-HD-BM0.14-0.37AU	1651670000
100	HDC-C-HD-SM0.5AU	1651630000	HDC-C-HD-BM0.5AU	1651680000
100	HDC-C-HD-SM0.75-1AU	1651640000	HDC-C-HD-BM0.75-1AU	1651690000
100	HDC-C-HD-SM1.5AU	1651650000	HDC-C-HD-BM1.5AU	1651700000
100	HDC-C-HD-SM2.5AU	1651660000	HDC-C-HD-BM2.5AU	1651710000



Single contacts

Conductor mm ²	AWG No.
0.14 - 0.37	22
0.50	20
0.75 - 1.00	18
1.50	16
2.50	14

Tools



Tool	Order No.
Crimping tool CTX CM 1.6/2.5	9018490000
Contact removal tool Removal Tool HD	1866730000

Selection of Housings RockStar® IP65
Size 2



Hood

Hood, Cable Entry sideways



a	Version	Cover	b (mm)	Designation	Order No.
M 20	with thread		68	HDC 15A TSLU 1M20G	1788860000
M 25	with thread		68	HDC 15A TSLU 1M25G	1788850000

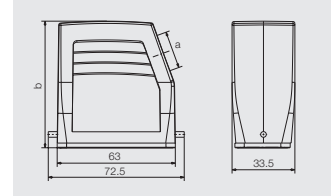

Hood, Cable Entry at top



a	Version	Cover	b (mm)	Designation	Order No.
M 20	with thread		54	HDC 10A TOLU 1M20G	1788620000
M 25	with thread		54	HDC 10A TOLU 1M25G	1788610000

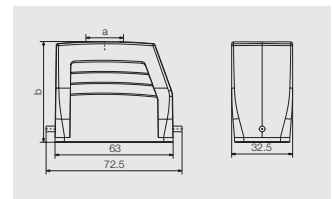

Cover



Version	Designation	Order No.
for hoods	HDC 10A DODL 1LB	1665890000

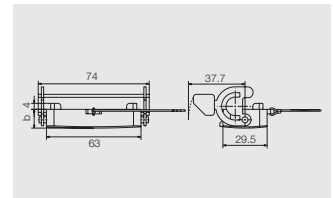

Base

Bulkhead housing



Version	Cover	b (mm)	Designation	Order No.
	with cover	37.5	HDC 10A ADLU	1664060000
		25	HDC 10A ALU	1664040000

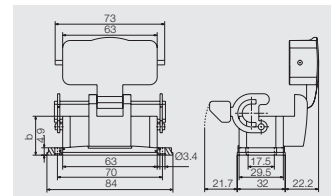

Base housing



a	Version	Cover	b (mm)	Designation	Order No.
M 20	with thread	with cover	69.5	HDC 10A SDLU 2M20G	1788660000
M 25	with thread	with cover	69.5	HDC 10A SDLU 2M25G	1788650000
M 20	with thread		57	HDC 10A SLU 2M20G	1788640000
M 25	with thread		57	HDC 10A SLU 2M25G	1788630000

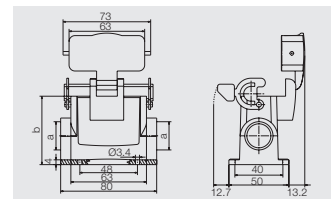

Coupling hood



a	Version	Cover	b (mm)	Designation	Order No.
M 25	with thread		48	HDC 10A KLU 1M25G	1788670000

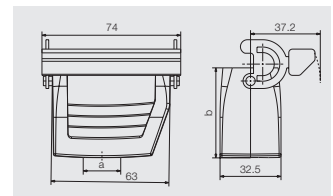

Cover



Version	Designation	Order No.
for bases	HDC 10A DMDL 2BO	1665880000

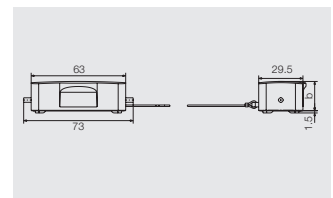

HD series - the flexible connectors

250 V, 10 A, Size 3

16 + ⊕

Inserts



Crimp connection



Insert	Designation	Order No.
Male	HDC HD 16 MC	1650710000
Female	HDC HD 16 FC	1650720000

Dimensions

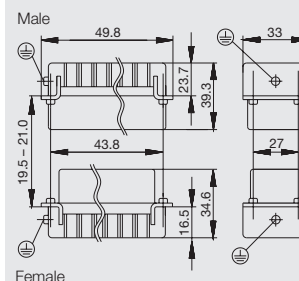

Arrangement of contacts

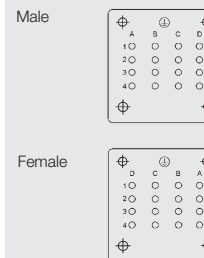

Mounting cut-out

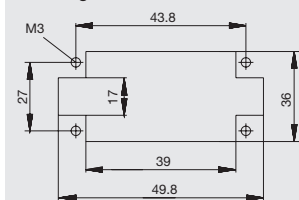

Accessories

Crimp contacts

Surface silver



Surface gold



Qty.	Male	Order No.	Female	Order No.
100	HDC-C-HD-SM0.14-0.37AG	1651520000	HDC-C-HD-BM0.14-0.37AG	1651570000
100	HDC-C-HD-SM0.5AG	1651530000	HDC-C-HD-BM0.5AG	1651580000
100	HDC-C-HD-SM0.75-1AG	1601750000	HDC-C-HD-BM0.75-1AG	1601760000
100	HDC-C-HD-SM1.5AG	1651550000	HDC-C-HD-BM1.5AG	1651600000
100	HDC-C-HD-SM2.5AG	1651560000	HDC-C-HD-BM2.5AG	1651610000
100	HDC-C-HD-SM0.14-0.37AU	1651620000	HDC-C-HD-BM0.14-0.37AU	1651670000
100	HDC-C-HD-SM0.5AU	1651630000	HDC-C-HD-BM0.5AU	1651680000
100	HDC-C-HD-SM0.75-1AU	1651640000	HDC-C-HD-BM0.75-1AU	1651690000
100	HDC-C-HD-SM1.5AU	1651650000	HDC-C-HD-BM1.5AU	1651700000
100	HDC-C-HD-SM2.5AU	1651660000	HDC-C-HD-BM2.5AU	1651710000



Single contacts

Conductor mm ²	AWG No.
0.14 - 0.37	22
0.50	20
0.75 - 1.00	18
1.50	16
2.50	14

Tools



Tool	Order No.
Crimping tool CTX CM 1.6/2.5	9018490000
Contact removal tool Removal Tool HD	1866730000

Selection of Housings RockStar® IP65
Size 3



Hood

Hood, Cable Entry sideways



a	Version	Cover	b (mm)	Designation	Order No.
M 20	with thread		52	HDC 06B TSLU 1M20G	1788100000
M 20	with thread		52	HDC 06B TSLU 1M20G	1805930000
M 25	with thread		52	HDC 06B TSLU 1M25G	1788090000
M 25	with thread		72	HDC 16D TSLU 1M25G	1787480000

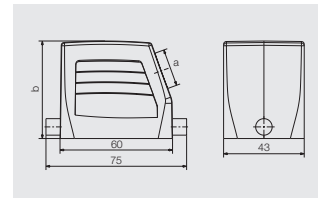

Hood, Cable Entry at top



a	Version	Cover	b (mm)	Designation	Order No.
M 20	with thread		52	HDC 06B TOLU 1M20G	1788120000
M 25	with thread		52	HDC 06B TOLU 1M25G	1788110000
M 25	with thread		72	HDC 16D TOLU 1M25G	1787500000
M 32	with thread		72	HDC 16D TOLU 1M32G	1787490000

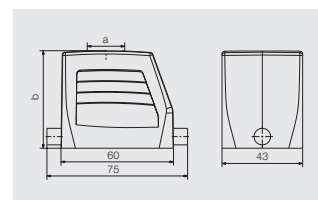

Cover



Version	Designation	Order No.
for hoods	HDC 06B DMDL 1LB	1665210000

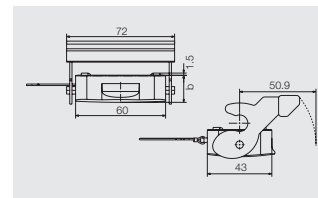

Base

Bulkhead housing



Version	Cover	b (mm)	Designation	Order No.
		29	HDC 06B ALU	1202100000
	with cover	47	HDC 06B ADLU	1202500000

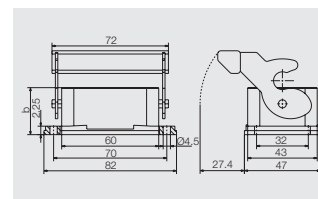

Base housing



a	Version	Cover	b (mm)	Designation	Order No.
M 20	with thread		54	HDC 06B SLU 2M20G	1788140000
M 20	with thread	with cover	72	HDC 06B SDLU 2M20G	1788170000
M 25	with thread		54	HDC 06B SLU 2M25G	1788130000
M 25	with thread	with cover	72	HDC 06B SDLU 2M25G	1788160000

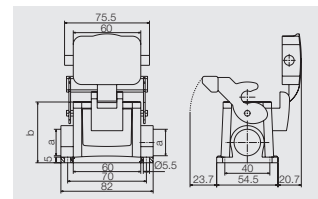

Cover



Version	Designation	Order No.
for bases	HDC 06B DODL 2BO	1665200000

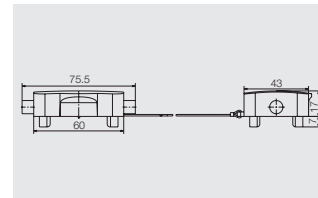

HD series - the flexible connectors

250 V, 10 A, Size 4

24 + ⊕

Inserts



Crimp connection



Insert	Designation	Order No.
Male	HDC HD 24 MC	1650870000
Female	HDC HD 24 FC	1650890000

Dimensions

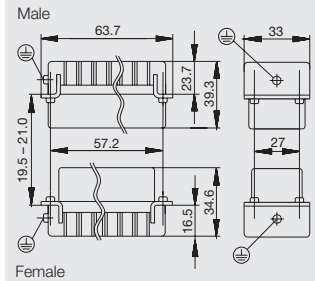

Arrangement of contacts

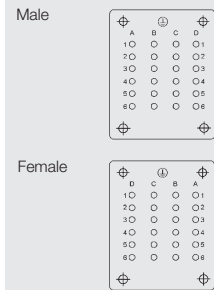

Mounting cut-out

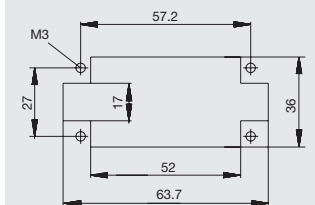

Accessories

Crimp contacts

Surface silver



Surface gold



Qty.	Male	Order No.	Female	Order No.
100	HDC-C-HD-SM0.14-0.37AG	1651520000	HDC-C-HD-BM0.14-0.37AG	1651570000
100	HDC-C-HD-SM0.5AG	1651530000	HDC-C-HD-BM0.5AG	1651580000
100	HDC-C-HD-SM0.75-1AG	1601750000	HDC-C-HD-BM0.75-1AG	1601760000
100	HDC-C-HD-SM1.5AG	1651550000	HDC-C-HD-BM1.5AG	1651600000
100	HDC-C-HD-SM2.5AG	1651560000	HDC-C-HD-BM2.5AG	1651610000
100	HDC-C-HD-SM0.14-0.37AU	1651620000	HDC-C-HD-BM0.14-0.37AU	1651670000
100	HDC-C-HD-SM0.5AU	1651630000	HDC-C-HD-BM0.5AU	1651680000
100	HDC-C-HD-SM0.75-1AU	1651640000	HDC-C-HD-BM0.75-1AU	1651690000
100	HDC-C-HD-SM1.5AU	1651650000	HDC-C-HD-BM1.5AU	1651700000
100	HDC-C-HD-SM2.5AU	1651660000	HDC-C-HD-BM2.5AU	1651710000



Single contacts

Conductor mm ²	AWG No.
0.14 - 0.37	22
0.50	20
0.75 - 1.00	18
1.50	16
2.50	14

Tools



Tool	Order No.
Crimping tool CTX CM 1.6/2.5	9018490000
Contact removal tool Removal Tool HD	1866730000

Selection of Housings RockStar® IP65
Size 4



Hood

Hood, Cable Entry sideways



a	Version	Cover	b (mm)	Designation	Order No.
M 20	with thread		52	HDC 10B TSBU 1M20G	1787560000
M 25	with thread		52	HDC 10B TSBU 1M25G	1787550000
M 25	with thread		72	HDC 24D TSBU 1M25G	1787240000
M 32	with thread		72	HDC 24D TSBU 1M32G	1787230000

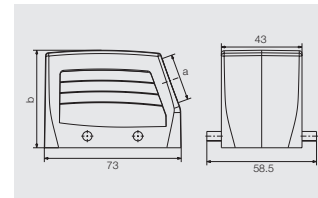

Hood, Cable Entry at top



a	Version	Cover	b (mm)	Designation	Order No.
M 20	with thread		52	HDC 10B TOBU 1M20G	1787600000
M 25	with thread		52	HDC 10B TOBU 1M25G	1787590000
M 25	with thread		72	HDC 24D TOBU 1M25G	1787300000
M 32	with thread		72	HDC 24D TOBU 1M32G	1787290000

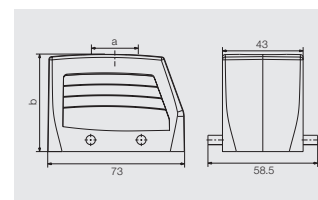

Cover



Version	Designation	Order No.
for hoods	HDC 10B DMDQ 2QB	1665240000

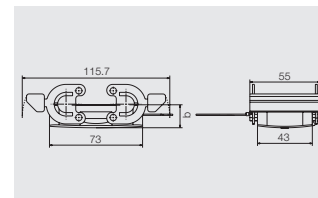

Base

Bulkhead housing



Version	Cover	b (mm)	Designation	Order No.
		29.3	HDC 10B ABU	1205000000

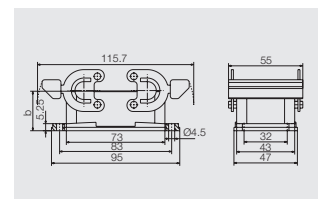

Base housing



a	Version	Cover	b (mm)	Designation	Order No.
M 20	with thread		57	HDC 10B SBU 2M20G	1787640000
M 25	with thread		57	HDC 10B SBU 2M25G	1787630000
M 25	with thread		74	HDC 24D SBU 2M25G	1787350000
M 32	with thread		74	HDC 24D SBU 2M32G	1787360000

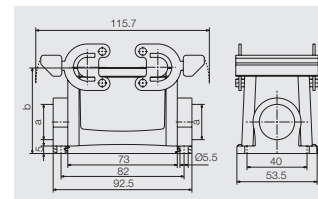

Coupling hood



a	Version	Cover	b (mm)	Designation	Order No.
M 20	with thread		55	HDC 10B KBU 1M20G	1787720000

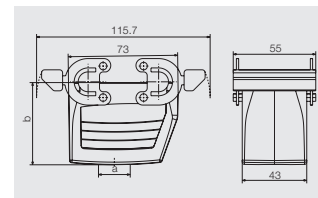

Cover



Version	Designation	Order No.
for bases	HDC 10B DODQ 4BO	1665230000

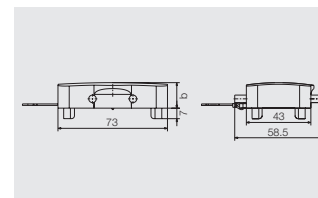

HD series - the flexible connectors

250 V, 10 A, Size 5

25 + ⊕

Inserts



Crimp connection



Insert	Designation	Order No.
Male	HDC HD 25 MC	1650810000
Female	HDC HD 25 FC	1650820000

Dimensions

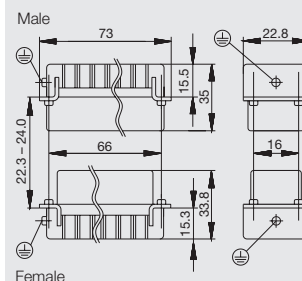

Arrangement of contacts

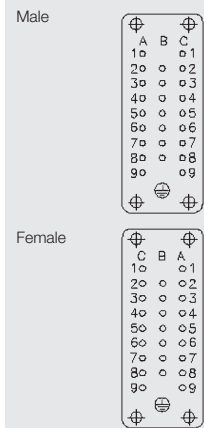

Mounting cut-out

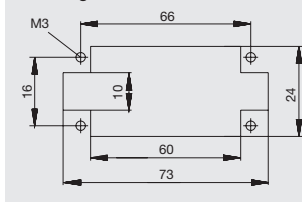

Accessories

Crimp contacts

Surface silver



Surface gold



Qty.	Male	Order No.	Female	Order No.
100	HDC-C-HD-SM0.14-0.37AG	1651520000	HDC-C-HD-BM0.14-0.37AG	1651570000
100	HDC-C-HD-SM0.5AG	1651530000	HDC-C-HD-BM0.5AG	1651580000
100	HDC-C-HD-SM0.75-1AG	1601750000	HDC-C-HD-BM0.75-1AG	1601760000
100	HDC-C-HD-SM1.5AG	1651550000	HDC-C-HD-BM1.5AG	1651600000
100	HDC-C-HD-SM2.5AG	1651560000	HDC-C-HD-BM2.5AG	1651610000
100	HDC-C-HD-SM0.14-0.37AU	1651620000	HDC-C-HD-BM0.14-0.37AU	1651670000
100	HDC-C-HD-SM0.5AU	1651630000	HDC-C-HD-BM0.5AU	1651680000
100	HDC-C-HD-SM0.75-1AU	1651640000	HDC-C-HD-BM0.75-1AU	1651690000
100	HDC-C-HD-SM1.5AU	1651650000	HDC-C-HD-BM1.5AU	1651700000
100	HDC-C-HD-SM2.5AU	1651660000	HDC-C-HD-BM2.5AU	1651710000

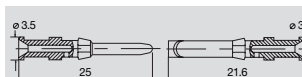

Single contacts

Conductor mm ²	AWG No.
0.14 - 0.37	22
0.50	20
0.75 - 1.00	18
1.50	16
2.50	14

Tools



Tool	Order No.
Crimping tool CTX CM 1.6/2.5	9018490000
Contact removal tool Removal Tool HD	1866730000

Selection of Housings RockStar® IP65
Size 5



Hood

Hood, Cable Entry sideways



a	Version	Cover	b (mm)	Designation	Order No.
M 25	with thread		58	HDC 16A TSLU 1M25G	1788740000
M 20	with thread		72	HDC 25A TSLU 1M20G	1788680000
M 25	with thread		72	HDC 25A TSLU 1M25G	1788690000

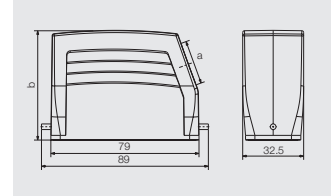

Hood, Cable Entry at top



a	Version	Cover	b (mm)	Designation	Order No.
M 25	with thread		58	HDC 16A TOLU 1M25G	1788750000
M 20	with thread		72	HDC 25A TOLU 1M20G	1788710000
M 25	with thread		72	HDC 25A TOLU 1M25G	1788700000

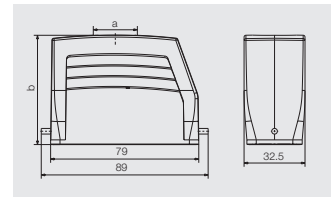

Cover



Version	Designation	Order No.
for hoods	HDC 16A DODL 1LB	1665900000

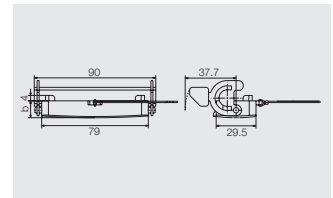

Base

Bulkhead housing



Version	Cover	b (mm)	Designation	Order No.
	with cover	44.5	HDC 16A ADLU	1664940000
		25	HDC 16A ALU	1664920000

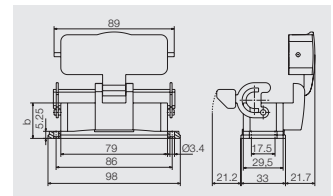

Base housing



a	Version	Cover	b (mm)	Designation	Order No.
M 20	with thread	with cover	76.5	HDC 16A SDLU 2M20G	1788790000
M 25	with thread	with cover	76.5	HDC 16A SDLU 2M25G	1788780000
M 20	with thread		57	HDC 16A SLU 2M20G	1788770000
M 25	with thread		57	HDC 16A SLU 2M25G	1788760000

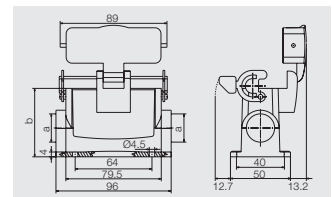

Coupling hood



a	Version	Cover	b (mm)	Designation	Order No.
M 25	with thread		53	HDC 16A KLU 1M25G	1788800000

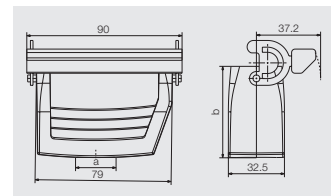

Cover



Version	Designation	Order No.
for bases	HDC 16A DMDL 2BO	1665910000

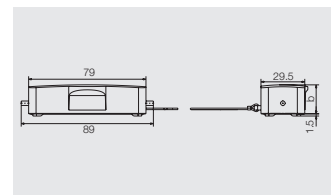

HD series - the flexible connectors

250 V, 10 A, Size 6

40 + ⊕

Inserts



Crimp connection



Insert	Designation	Order No.
Male	HDC HD 40 MC	1601710000
Female	HDC HD 40 FC	1601730000

Dimensions

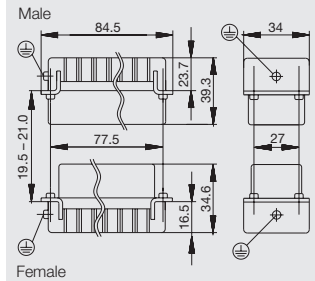

Arrangement of contacts

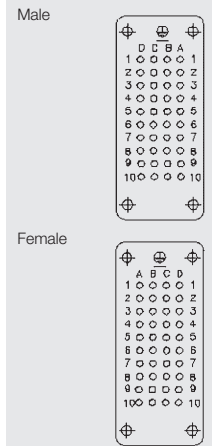

Mounting cut-out

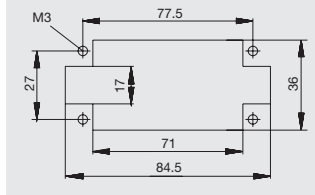

Accessories

Crimp contacts

Surface silver



Surface gold



Qty.	Male	Order No.	Female	Order No.
100	HDC-C-HD-SM0.14-0.37AG	1651520000	HDC-C-HD-BM0.14-0.37AG	1651570000
100	HDC-C-HD-SM0.5AG	1651530000	HDC-C-HD-BM0.5AG	1651580000
100	HDC-C-HD-SM0.75-1AG	1601750000	HDC-C-HD-BM0.75-1AG	1601760000
100	HDC-C-HD-SM1.5AG	1651550000	HDC-C-HD-BM1.5AG	1651600000
100	HDC-C-HD-SM2.5AG	1651560000	HDC-C-HD-BM2.5AG	1651610000
100	HDC-C-HD-SM0.14-0.37AU	1651620000	HDC-C-HD-BM0.14-0.37AU	1651670000
100	HDC-C-HD-SM0.5AU	1651630000	HDC-C-HD-BM0.5AU	1651680000
100	HDC-C-HD-SM0.75-1AU	1651640000	HDC-C-HD-BM0.75-1AU	1651690000
100	HDC-C-HD-SM1.5AU	1651650000	HDC-C-HD-BM1.5AU	1651700000
100	HDC-C-HD-SM2.5AU	1651660000	HDC-C-HD-BM2.5AU	1651710000



Single contacts	AWG No.
Conductor mm ²	
0.14 - 0.37	22
0.50	20
0.75 - 1.00	18
1.50	16
2.50	14

Tools



Crimping tool	Order No.
CTX CM 1.6/2.5	9018490000
Contact removal tool	Order No.
Removal Tool HD	1866730000

**Selection of Housings RockStar® IP65
Size 6**



Hood

Hood, Cable Entry sideways



a	Version	Cover	b (mm)	Designation	Order No.
M 25	with thread		61	HDC 16B TSBU 1M25G	1788180000
M 25	with thread		76	HDC 40D TSBU 1M25G	1787010000
M 32	with thread		76	HDC 40D TSBU 1M32G	1787000000

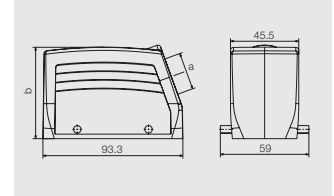

Hood, Cable Entry at top



a	Version	Cover	b (mm)	Designation	Order No.
M 25	with thread		61	HDC 16B TOBU 1M25G	1788210000
M 25	with thread		76	HDC 40D TOBU 1M25G	1787070000
M 32	with thread		76	HDC 40D TOBU 1M32G	1787060000

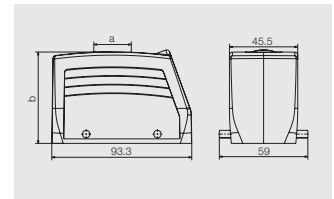

Cover

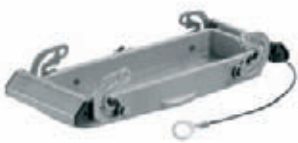

Version	Designation	Order No.
for hoods	HDC 16B DMDQ 2QB	1665270000

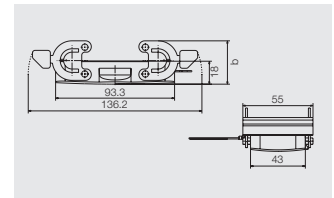

Base

Bulkhead housing



Version	Cover	b (mm)	Designation	Order No.
		29	HDC 16B ABU	1208600000

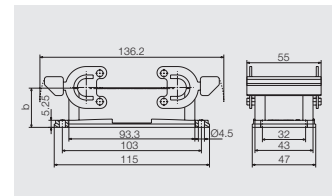

Base housing



a	Version	Cover	b (mm)	Designation	Order No.
M 25	with thread		64	HDC 16B SBU 2M25G	1788240000
M 25	with thread		84	HDC 40D SBU 2M25G	1787120000
M 32	with thread		84	HDC 40D SBU 2M32G	1787110000

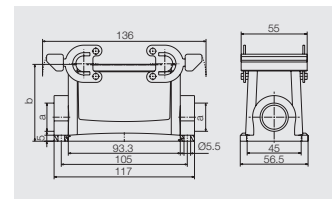

Coupling hood



a	Version	Cover	b (mm)	Designation	Order No.
M 25	with thread		79	HDC 40D KBU 1M25G	1787200000
M 32	with thread		79	HDC 40D KBU 1M32G	1787190000

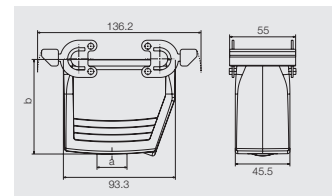

Cover



Version	Designation	Order No.
for bases	HDC 16B DODQ 4BO	1665260000

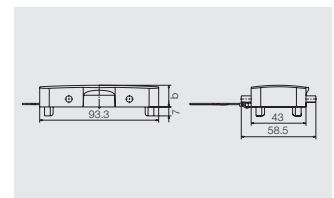

HD series - the flexible connectors

250 V, 10 A, Size 7

50 + ⊕

Inserts



Crimp connection



Insert	Designation	Order No.
Male	HDC HD 25 MC	1650810000
Female	HDC HD 25 FC	1650820000

Note Please use this type of insert twice to create 50 pole units.

Dimensions

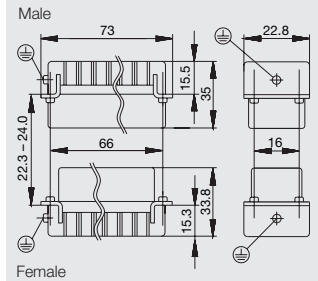

Arrangement of contacts

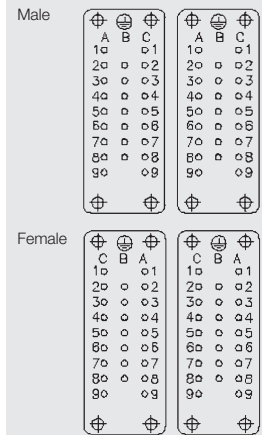

Mounting cut-out

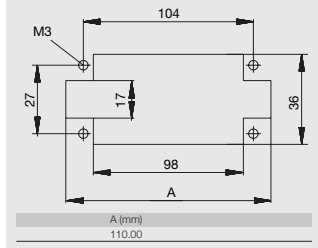

Accessories

Crimp contacts

Surface silver



Surface gold



Qty.	Male	Order No.	Female	Order No.
100	HDC-C-HD-SM0.14-0.37AG	1651520000	HDC-C-HD-BM0.14-0.37AG	1651570000
100	HDC-C-HD-SM0.5AG	1651530000	HDC-C-HD-BM0.5AG	1651580000
100	HDC-C-HD-SM0.75-1AG	1601750000	HDC-C-HD-BM0.75-1AG	1601760000
100	HDC-C-HD-SM1.5AG	1651550000	HDC-C-HD-BM1.5AG	1651600000
100	HDC-C-HD-SM2.5AG	1651560000	HDC-C-HD-BM2.5AG	1651610000
100	HDC-C-HD-SM0.14-0.37AU	1651620000	HDC-C-HD-BM0.14-0.37AU	1651670000
100	HDC-C-HD-SM0.5AU	1651630000	HDC-C-HD-BM0.5AU	1651680000
100	HDC-C-HD-SM0.75-1AU	1651640000	HDC-C-HD-BM0.75-1AU	1651690000
100	HDC-C-HD-SM1.5AU	1651650000	HDC-C-HD-BM1.5AU	1651700000
100	HDC-C-HD-SM2.5AU	1651660000	HDC-C-HD-BM2.5AU	1651710000



Single contacts

Conductor mm ²	AWG No.
0.14 - 0.37	22
0.50	20
0.75 - 1.00	18
1.50	16
2.50	14

Tools



Tool	Order No.
Crimping tool CTX CM 1.6/2.5	9018490000
Contact removal tool Removal Tool HD	1866730000

Selection of Housings RockStar® IP65
Size 7



Hood

Hood, Cable Entry sideways



a	Version	Cover	b (mm)	Designation	Order No.
M 25	with thread		75	HDC 32A TSBU 1M25G	1787960000
M 32	with thread		75	HDC 32A TSBU 1M32G	1787950000

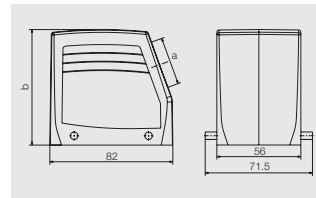

Hood, Cable Entry at top



a	Version	Cover	b (mm)	Designation	Order No.
M 32	with thread		75	HDC 32A TOBU 1M32G	1787990000

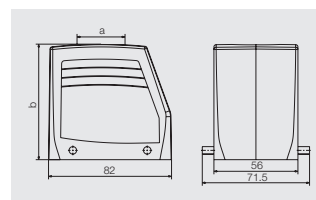

Base

Bulkhead housing



Version	Cover	b (mm)	Designation	Order No.
		25	HDC 32A ABU	1665860000

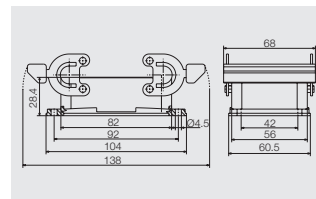

Base housing



a	Version	Cover	b (mm)	Designation	Order No.
M 25	with thread		75	HDC 32A SBU 2M25G	1788040000

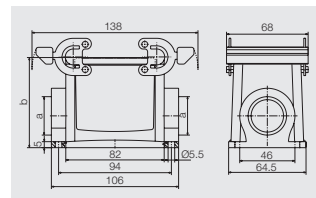

Coupling hood



a	Version	Cover	b (mm)	Designation	Order No.
M 25	with thread		76.5	HDC 32A KBU 1M25G	1788080000
M 32	with thread		76.5	HDC 32A KBU 1M32G	1788070000

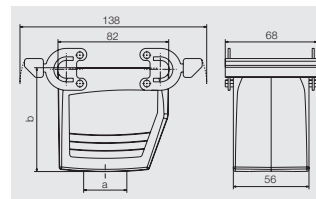

HD series - the flexible connectors

250 V, 10 A, Size 8

64 + ⊕

Inserts



Crimp connection



Insert	Designation	Order No.
Male	HDC HD 64 MC	1601720000
Female	HDC HD 64 FC	1601740000

Dimensions

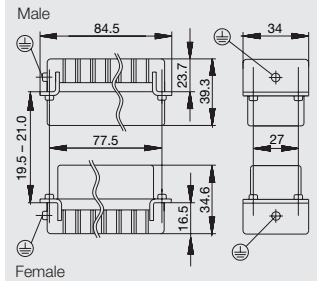

Arrangement of contacts

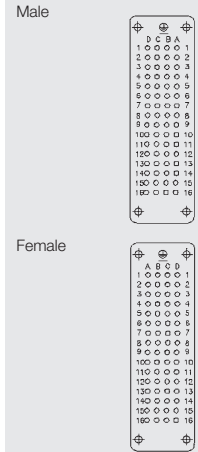

Mounting cut-out

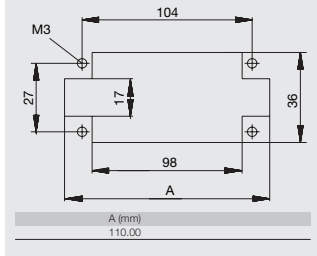

Accessories

Crimp contacts

Surface silver



Surface gold



Qty.	Male	Order No.	Female	Order No.
100	HDC-C-HD-SM0.14-0.37AG	1651520000	HDC-C-HD-BM0.14-0.37AG	1651570000
100	HDC-C-HD-SM0.5AG	1651530000	HDC-C-HD-BM0.5AG	1651580000
100	HDC-C-HD-SM0.75-1AG	1601750000	HDC-C-HD-BM0.75-1AG	1601760000
100	HDC-C-HD-SM1.5AG	1651550000	HDC-C-HD-BM1.5AG	1651600000
100	HDC-C-HD-SM2.5AG	1651560000	HDC-C-HD-BM2.5AG	1651610000
100	HDC-C-HD-SM0.14-0.37AU	1651620000	HDC-C-HD-BM0.14-0.37AU	1651670000
100	HDC-C-HD-SM0.5AU	1651630000	HDC-C-HD-BM0.5AU	1651680000
100	HDC-C-HD-SM0.75-1AU	1651640000	HDC-C-HD-BM0.75-1AU	1651690000
100	HDC-C-HD-SM1.5AU	1651650000	HDC-C-HD-BM1.5AU	1651700000
100	HDC-C-HD-SM2.5AU	1651660000	HDC-C-HD-BM2.5AU	1651710000



Single contacts

Conductor mm ²	AWG No.
0.14 - 0.37	22
0.50	20
0.75 - 1.00	18
1.50	16
2.50	14

Tools



Crimping tool	Order No.
CTX CM 1.6/2.5	9018490000
Contact removal tool	Order No.
Removal Tool HD	1866730000

Selection of Housings RockStar® IP65
Size 8



Hood

Hood, Cable Entry sideways



a	Version	Cover	b (mm)	Designation	Order No.
M 25	with thread		61	HDC 24B TSBU 1M25G	1787760000
M 32	with thread		61	HDC 24B TSBU 1M32G	1787750000
M 25	with thread		76	HDC 64D TSBU 1M25G	1786780000
M 32	with thread		76	HDC 64D TSBU 1M32G	1786770000

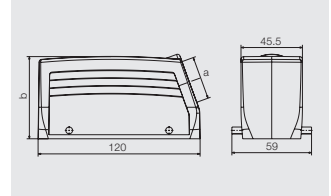

Hood, Cable Entry at top



a	Version	Cover	b (mm)	Designation	Order No.
M 25	with thread		61	HDC 24B TOBU 1M25G	1787820000
M 32	with thread		61	HDC 24B TOBU 1M32G	1787810000
M 32	with thread		76	HDC 64D TOBU 1M32G	1786830000

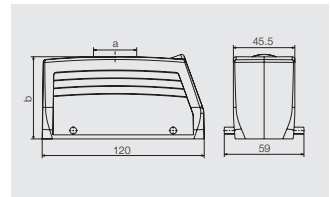

Cover

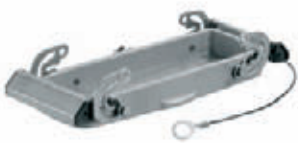

Version	Designation	Order No.
for hoods	HDC 24B DMDQ 2QB	1665640000

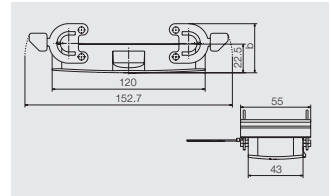

Base

Bulkhead housing



Version	Cover	b (mm)	Designation	Order No.
		29.3	HDC 24B ABU	1212400000

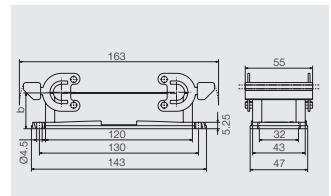

Base housing



a	Version	Cover	b (mm)	Designation	Order No.
M 25	with thread		64	HDC 24B SBU 2M25G	1787870000
M 25	with thread		84	HDC 64D SBU 2M25G	1786890000
M 32	with thread		84	HDC 64D SBU 2M32G	1786880000

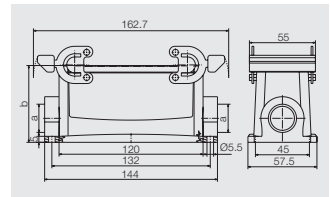

Coupling hood



a	Version	Cover	b (mm)	Designation	Order No.
M 25	with thread		65	HDC 24B KBU 1M25G	1787920000
M 32	with thread		79	HDC 64D KBU 1M32G	1786960000

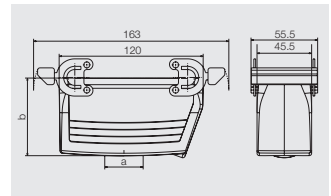

Cover



Version	Designation	Order No.
for bases	HDC 24B DODQ 4BO	1665630000

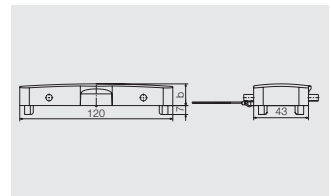

HD series - the flexible connectors

250 V, 10 A, Size 10

80 + ⊕

Inserts



Crimp connection



Insert	Designation	Order No.
Male	HDC HD 40 MC	1601710000
Female	HDC HD 40 FC	1601730000

Note Please use this type of insert twice to create 40 pole units.

Dimensions

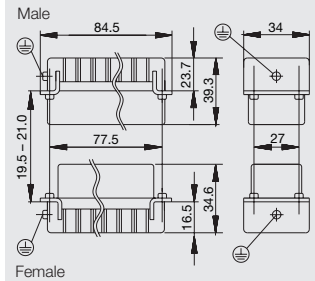

Arrangement of contacts

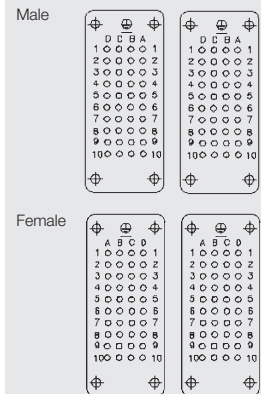

Mounting cut-out

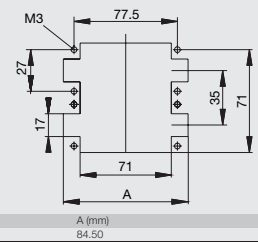

Accessories

Crimp contacts

Surface silver



Surface gold



Qty.	Male	Order No.	Female	Order No.
100	HDC-C-HD-SM0.14-0.37AG	1651520000	HDC-C-HD-BM0.14-0.37AG	1651570000
100	HDC-C-HD-SM0.5AG	1651530000	HDC-C-HD-BM0.5AG	1651580000
100	HDC-C-HD-SM0.75-1AG	1601750000	HDC-C-HD-BM0.75-1AG	1601760000
100	HDC-C-HD-SM1.5AG	1651550000	HDC-C-HD-BM1.5AG	1651600000
100	HDC-C-HD-SM2.5AG	1651560000	HDC-C-HD-BM2.5AG	1651610000
100	HDC-C-HD-SM0.14-0.37AU	1651620000	HDC-C-HD-BM0.14-0.37AU	1651670000
100	HDC-C-HD-SM0.5AU	1651630000	HDC-C-HD-BM0.5AU	1651680000
100	HDC-C-HD-SM0.75-1AU	1651640000	HDC-C-HD-BM0.75-1AU	1651690000
100	HDC-C-HD-SM1.5AU	1651650000	HDC-C-HD-BM1.5AU	1651700000
100	HDC-C-HD-SM2.5AU	1651660000	HDC-C-HD-BM2.5AU	1651710000



Single contacts

Conductor mm ²	AWG No.
0.14 - 0.37	22
0.50	20
0.75 - 1.00	18
1.50	16
2.50	14

Tools



Tool	Order No.
Crimping tool CTX CM 1.6/2.5	9018490000
Contact removal tool Removal Tool HD	1866730000

Selection of Housings RockStar® IP65
Size 10



Hood

Hood, Cable Entry sideways



a	Version	Cover	b (mm)	Designation	Order No.
M 32	with thread		79	HDC 32B TSLU 1M32G	1788420000

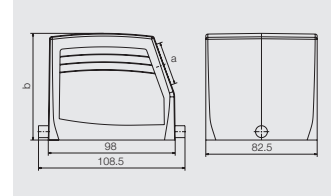

Base

Bulkhead housing



Version	Cover	b (mm)	Designation	Order No.
	with cover	55	HDC 32B ADLU	1219800000
		38	HDC 32B ALU	1219500000

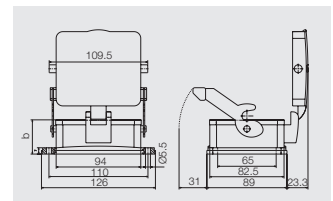

Base housing



a	Version	Cover	b (mm)	Designation	Order No.
M 32	with thread	with cover	96	HDC 32B SDLU 2M32G	1788490000
M 32	with thread		79	HDC 32B SLU 2M32G	1788470000

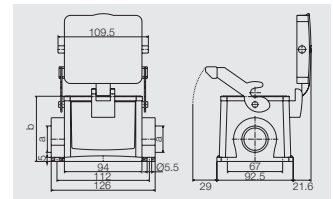

Coupling hood



a	Version	Cover	b (mm)	Designation	Order No.
M 32	with thread		83	HDC 32B KLU 1M32G	1788500000

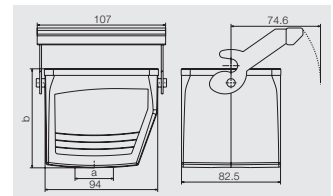

HD series - the flexible connectors

250 V, 10 A, Size 12

128 + ⊕

Inserts



Crimp connection



Insert	Designation	Order No.
Male	HDC HD 64 MC	1601720000
Female	HDC HD 64 FC	1601740000

Note Please use this type of insert twice to create 128 pole units.

Dimensions

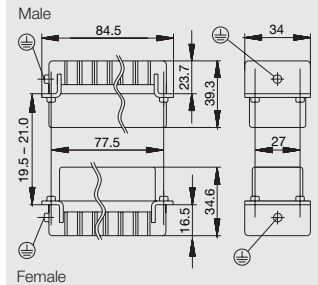

Arrangement of contacts

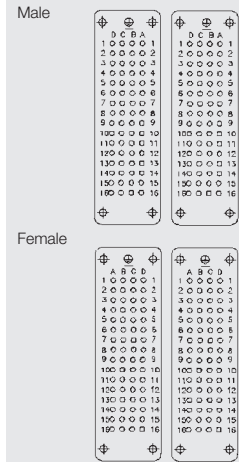

Mounting cut-out

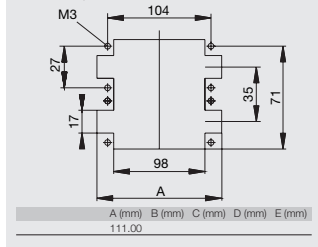

Accessories

Crimp contacts

Surface silver



Surface gold



Qty.	Male	Order No.	Female	Order No.
100	HDC-C-HD-SM0.14-0.37AG	1651520000	HDC-C-HD-BM0.14-0.37AG	1651570000
100	HDC-C-HD-SM0.5AG	1651530000	HDC-C-HD-BM0.5AG	1651580000
100	HDC-C-HD-SM0.75-1AG	1601750000	HDC-C-HD-BM0.75-1AG	1601760000
100	HDC-C-HD-SM1.5AG	1651550000	HDC-C-HD-BM1.5AG	1651600000
100	HDC-C-HD-SM2.5AG	1651560000	HDC-C-HD-BM2.5AG	1651610000
100	HDC-C-HD-SM0.14-0.37AU	1651620000	HDC-C-HD-BM0.14-0.37AU	1651670000
100	HDC-C-HD-SM0.5AU	1651630000	HDC-C-HD-BM0.5AU	1651680000
100	HDC-C-HD-SM0.75-1AU	1651640000	HDC-C-HD-BM0.75-1AU	1651690000
100	HDC-C-HD-SM1.5AU	1651650000	HDC-C-HD-BM1.5AU	1651700000
100	HDC-C-HD-SM2.5AU	1651660000	HDC-C-HD-BM2.5AU	1651710000



Single contacts

Conductor mm ²	AWG No.
0.14 - 0.37	22
0.50	20
0.75 - 1.00	18
1.50	16
2.50	14

Tools



Tool	Order No.
Crimping tool CTX CM 1.6/2.5	9018490000
Contact removal tool Removal Tool HD	1866730000

**Selection of Housings RockStar® IP65
Size 12**



Hood

Hood, Cable Entry sideways



a	Version	Cover	b (mm)	Designation	Order No.
M 32	with thread		94	HDC 48B TSLU 1M32G	1788320000
M 40	with thread		94	HDC 48B TSLU 1M40G	1788310000
M 50	with thread		94	HDC 48B TSLU 1M50G	1788300000

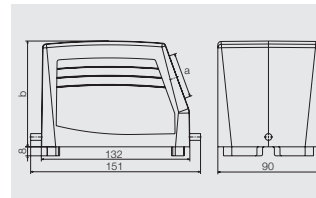

Hood, Cable Entry at top



a	Version	Cover	b (mm)	Designation	Order No.
M 32	with thread		94	HDC 48B TOLU 1M32G	1788350000
M 50	with thread		94	HDC 48B TOLU 1M50G	1788330000

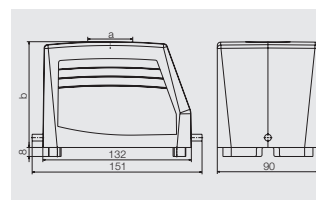

Base

Bulkhead housing



Version	Cover	b (mm)	Designation	Order No.
	with cover	62	HDC 48B ADLU	1222900000

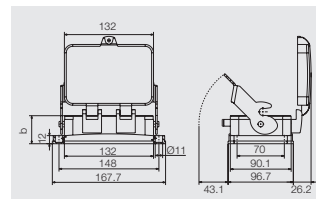

Base housing

a	Version	Cover	b (mm)	Designation	Order No.
M 32	with thread	with cover	120	HDC 48B SDLU 2M32G	1788390000
M 32	with thread		100	HDC 48B SLU 2M32G	1788370000
M 40	with thread		100	HDC 48B SLU 2M40G	1788360000

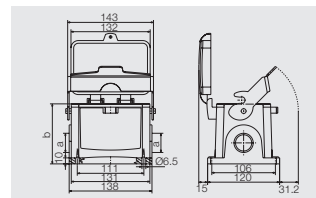

HDD series – the compact connectors

The HDD series with turned contacts is designed for many poles in a small space. The compact housing design saves the user space without compromising the number of poles.



Technical data





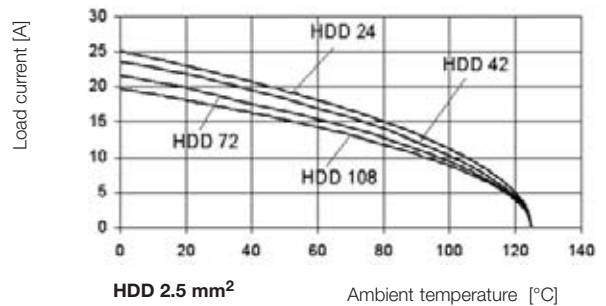
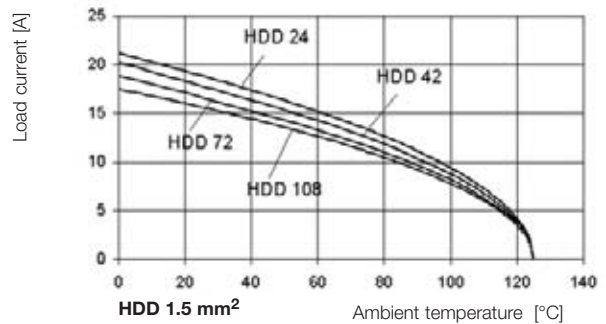

Standards / approvals	
Standards	DIN EN 61984 DIN EN 60664-1
Approvals	UL/CSA
Inserts	
No. of poles	24, 42, 72, 108, 144, 216 + PE
Rated voltage	250 V
Rated voltage to UL/CSA	600 V
Rated current	10 A
Rated impulse withstand voltage	4 kV
Pollution severity	3
Insulation resistance	$\geq 10^{10} \Omega$
Material	Glass-fibre reinforced PC (in UL list and approved for railway applications)
Temperature range	-40 °C ... +125 °C
Flammability to UL 94	V-0
Mechanical service life	
- Plugging cycles Ag - Surface	≥ 500
- Plugging cycles Au - Surface	≥ 500
Contact resistance	
Crimp connection	$\leq 4 \text{ m}\Omega$
Contacts / Material	
Sockets and plug-in contact	Copper alloy
Surface	Passivated silver, or 0.8 μm gold on 2 μm nickel
Crimp connection	
- Flexible conductor connection	0.14 ... 2.5 mm ² (AWG 26 ... 14)
- Stripping length	8.0 mm
Clamping torque	
- Screw connection	
SD blades	
- Screw connection	
- Push In	
- Tension clamp connection	
PE connection	
- Clamping range	0.5 ... 4 mm ²
- solid / stranded	0.5 ... 4 mm ² / 0.5 ... 4 mm ²
- flexible / flexible with wire end ferrule, DIN 46228 pt. 1	0.5 ... 4 mm ² / 0.5 ... 4 mm ²
- AWG conductor	AWG 20 ... 12
- Stripping length	10 mm
- Clamping torque	1.2 ... 1.5 Nm
- Blade dimensions	SD 0.8 x 4 mm or PZ 1

Note: Switch off power supply before handling plug-in connectors.

Derating curves



Overview

	Rated voltage	Rated current	No. of poles	Tension clamp connection	Screw conn. with wire guard spring	Crimp connection	Push In	Axial screw connection	Page
	250 V	10 A	24 + ⊕			•			B.66
	250 V	10 A	42 + ⊕			•			B.68
	250 V	10 A	72 + ⊕			•			B.70
	250 V	10 A	108 + ⊕			•			B.72
	250 V	10 A	144 + ⊕			•			B.74
	250 V	10 A	216 + ⊕			•			B.76

HDD series - the compact connectors

250 V, 10 A, Size 3

24 + ⊕

Inserts



Crimp connection



Insert	Designation	Order No.
Male	HDC HDD 24 MC	1651150000
Female	HDC HDD 24 FC	1651160000

Dimensions

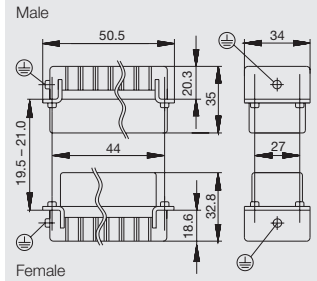

Arrangement of contacts

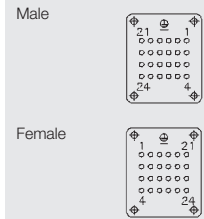

Mounting cut-out

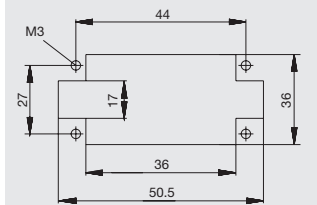

Accessories

Crimp contacts

Surface silver



Surface gold



Qty.	Male	Order No.	Female	Order No.
100	HDC-C-HD-SM0.14-0.37AG	1651520000	HDC-C-HD-BM0.14-0.37AG	1651570000
100	HDC-C-HD-SM0.5AG	1651530000	HDC-C-HD-BM0.5AG	1651580000
100	HDC-C-HD-SM0.75-1AG	1601750000	HDC-C-HD-BM0.75-1AG	1601760000
100	HDC-C-HD-SM1.5AG	1651550000	HDC-C-HD-BM1.5AG	1651600000
100	HDC-C-HD-SM2.5AG	1651560000	HDC-C-HD-BM2.5AG	1651610000
100	HDC-C-HD-SM0.14-0.37AU	1651620000	HDC-C-HD-BM0.14-0.37AU	1651670000
100	HDC-C-HD-SM0.5AU	1651630000	HDC-C-HD-BM0.5AU	1651680000
100	HDC-C-HD-SM0.75-1AU	1651640000	HDC-C-HD-BM0.75-1AU	1651690000
100	HDC-C-HD-SM1.5AU	1651650000	HDC-C-HD-BM1.5AU	1651700000
100	HDC-C-HD-SM2.5AU	1651660000	HDC-C-HD-BM2.5AU	1651710000



Single contacts

Conductor mm ²	AWG No.
0.14 - 0.37	22
0.50	20
0.75 - 1.00	18
1.50	16
2.50	14

Tools



Crimping tool	Order No.
CTX CM 1.6/2.5	9018490000
Contact removal tool	Order No.
Removal Tool HD	1866730000

Selection of Housings RockStar® IP65
Size 3



Hood

Hood, Cable Entry sideways



a	Version	Cover	b (mm)	Designation	Order No.
M 20	with thread		52	HDC 06B TSLU 1M20G	1788100000
M 20	with thread		52	HDC 06B TSLU 1M20G	1805930000
M 25	with thread		52	HDC 06B TSLU 1M25G	1788090000
M 25	with thread		72	HDC 16D TSLU 1M25G	1787480000

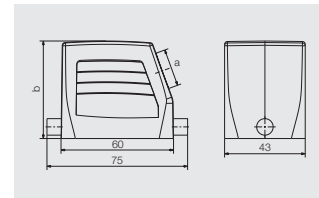

Hood, Cable Entry at top



a	Version	Cover	b (mm)	Designation	Order No.
M 20	with thread		52	HDC 06B TOLU 1M20G	1788120000
M 25	with thread		52	HDC 06B TOLU 1M25G	1788110000
M 25	with thread		72	HDC 16D TOLU 1M25G	1787500000
M 32	with thread		72	HDC 16D TOLU 1M32G	1787490000

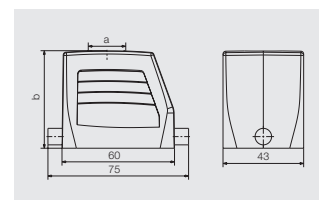

Cover



Version	Designation	Order No.
for hoods	HDC 06B DMDL 1LB	1665210000

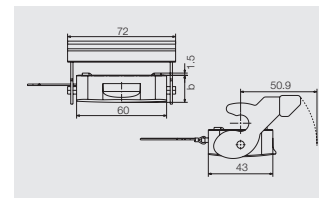

Base

Bulkhead housing



Version	Cover	b (mm)	Designation	Order No.
		29	HDC 06B ALU	1202100000
	with cover	47	HDC 06B ADLU	1202500000

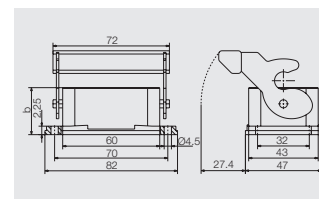

Base housing



a	Version	Cover	b (mm)	Designation	Order No.
M 20	with thread		54	HDC 06B SLU 2M20G	1788140000
M 20	with thread	with cover	72	HDC 06B SDLU 2M20G	1788170000
M 25	with thread		54	HDC 06B SLU 2M25G	1788130000
M 25	with thread	with cover	72	HDC 06B SDLU 2M25G	1788160000

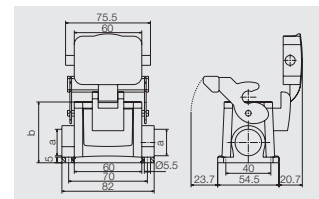

Cover



Version	Designation	Order No.
for bases	HDC 06B DODL 2BO	1665200000

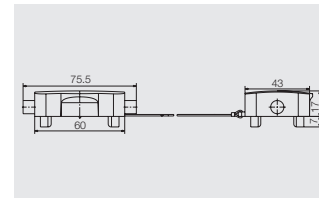

HDD series - the compact connectors

250 V, 10 A, Size 4

42 + ⊕

Inserts



Crimp connection



Insert	Designation	Order No.
Male	HDC HDD 42 MC	1651170000
Female	HDC HDD 42 FC	1651180000

Dimensions

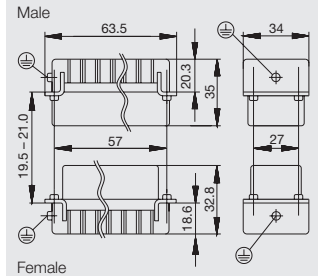

Arrangement of contacts

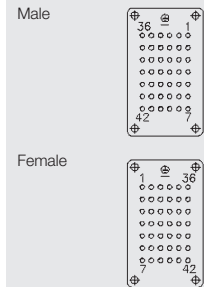

Mounting cut-out

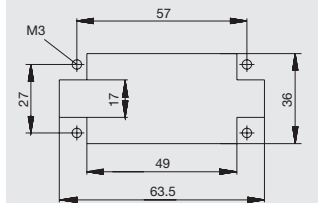

Accessories

Crimp contacts

Surface silver



Surface gold



Qty.	Male	Order No.	Female	Order No.
100	HDC-C-HD-SM0.14-0.37AG	1651520000	HDC-C-HD-BM0.14-0.37AG	1651570000
100	HDC-C-HD-SM0.5AG	1651530000	HDC-C-HD-BM0.5AG	1651580000
100	HDC-C-HD-SM0.75-1AG	1601750000	HDC-C-HD-BM0.75-1AG	1601760000
100	HDC-C-HD-SM1.5AG	1651550000	HDC-C-HD-BM1.5AG	1651600000
100	HDC-C-HD-SM2.5AG	1651560000	HDC-C-HD-BM2.5AG	1651610000
100	HDC-C-HD-SM0.14-0.37AU	1651620000	HDC-C-HD-BM0.14-0.37AU	1651670000
100	HDC-C-HD-SM0.5AU	1651630000	HDC-C-HD-BM0.5AU	1651680000
100	HDC-C-HD-SM0.75-1AU	1651640000	HDC-C-HD-BM0.75-1AU	1651690000
100	HDC-C-HD-SM1.5AU	1651650000	HDC-C-HD-BM1.5AU	1651700000
100	HDC-C-HD-SM2.5AU	1651660000	HDC-C-HD-BM2.5AU	1651710000



Single contacts

Conductor mm ²	AWG No.
0.14 - 0.37	22
0.50	20
0.75 - 1.00	18
1.50	16
2.50	14

Tools



Tool	Order No.
Crimping tool CTX CM 1.6/2.5	9018490000
Contact removal tool Removal Tool HD	1866730000

Selection of Housings RockStar® IP65
Size 4



Hood

Hood, Cable Entry sideways



a	Version	Cover	b (mm)	Designation	Order No.
M 20	with thread		52	HDC 10B TSBU 1M20G	1787560000
M 25	with thread		52	HDC 10B TSBU 1M25G	1787550000
M 25	with thread		72	HDC 24D TSBU 1M25G	1787240000
M 32	with thread		72	HDC 24D TSBU 1M32G	1787230000

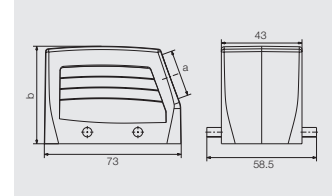

Hood, Cable Entry at top



a	Version	Cover	b (mm)	Designation	Order No.
M 20	with thread		52	HDC 10B TOBU 1M20G	1787600000
M 25	with thread		52	HDC 10B TOBU 1M25G	1787590000
M 25	with thread		72	HDC 24D TOBU 1M25G	1787300000
M 32	with thread		72	HDC 24D TOBU 1M32G	1787290000

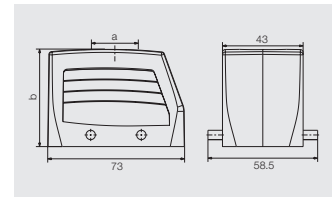

Cover



Version	Designation	Order No.
for hoods	HDC 10B DMDQ 2QB	1665240000

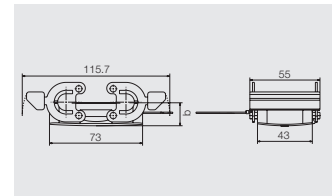

Base

Bulkhead housing



Version	Cover	b (mm)	Designation	Order No.
		29.3	HDC 10B ABU	1205000000

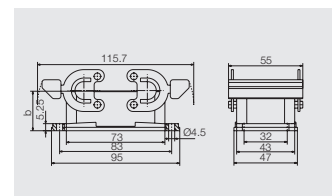

Base housing



a	Version	Cover	b (mm)	Designation	Order No.
M 20	with thread		57	HDC 10B SBU 2M20G	1787640000
M 25	with thread		57	HDC 10B SBU 2M25G	1787630000
M 25	with thread		74	HDC 24D SBU 2M25G	1787350000
M 32	with thread		74	HDC 24D SBU 2M32G	1787360000

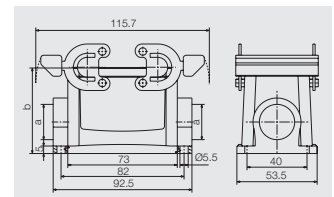

Coupling hood



a	Version	Cover	b (mm)	Designation	Order No.
M 20	with thread		55	HDC 10B KBU 1M20G	1787720000

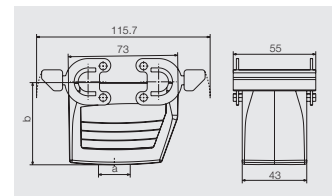

Cover



Version	Designation	Order No.
for bases	HDC 10B DODQ 4BO	1665230000

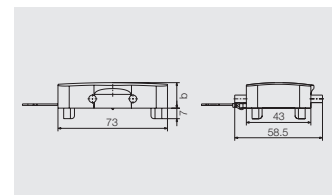

HDD series - the compact connectors

250 V, 10 A, Size 6

72 + ⊕

Inserts



Crimp connection



Insert	Designation	Order No.
Male	HDC HDD 72 MC	1651190000
Female	HDC HDD 72 FC	1651200000

Dimensions

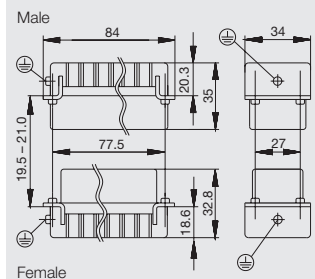

Arrangement of contacts

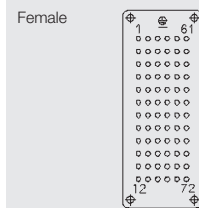
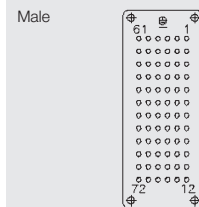

Mounting cut-out

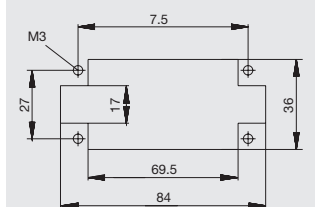

Accessories

Crimp contacts

Surface silver



Surface gold



Qty.	Male	Order No.	Female	Order No.
100	HDC-C-HD-SM0.14-0.37AG	1651520000	HDC-C-HD-BM0.14-0.37AG	1651570000
100	HDC-C-HD-SM0.5AG	1651530000	HDC-C-HD-BM0.5AG	1651580000
100	HDC-C-HD-SM0.75-1AG	1601750000	HDC-C-HD-BM0.75-1AG	1601760000
100	HDC-C-HD-SM1.5AG	1651550000	HDC-C-HD-BM1.5AG	1651600000
100	HDC-C-HD-SM2.5AG	1651560000	HDC-C-HD-BM2.5AG	1651610000
100	HDC-C-HD-SM0.14-0.37AU	1651620000	HDC-C-HD-BM0.14-0.37AU	1651670000
100	HDC-C-HD-SM0.5AU	1651630000	HDC-C-HD-BM0.5AU	1651680000
100	HDC-C-HD-SM0.75-1AU	1651640000	HDC-C-HD-BM0.75-1AU	1651690000
100	HDC-C-HD-SM1.5AU	1651650000	HDC-C-HD-BM1.5AU	1651700000
100	HDC-C-HD-SM2.5AU	1651660000	HDC-C-HD-BM2.5AU	1651710000



Single contacts

Conductor mm ²	AWG No.
0.14 - 0.37	22
0.50	20
0.75 - 1.00	18
1.50	16
2.50	14

Tools



Crimping tool	Order No.
CTX CM 1.6/2.5	9018490000
Contact removal tool	Order No.
Removal Tool HD	1866730000

Selection of Housings RockStar® IP65
Size 6



Hood

Hood, Cable Entry sideways



a	Version	Cover	b (mm)	Designation	Order No.
M 25	with thread		61	HDC 16B TSBU 1M25G	1788180000
M 25	with thread		76	HDC 40D TSBU 1M25G	1787010000
M 32	with thread		76	HDC 40D TSBU 1M32G	1787000000

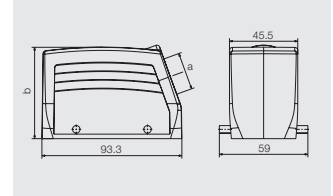

Hood, Cable Entry at top



a	Version	Cover	b (mm)	Designation	Order No.
M 25	with thread		61	HDC 16B TOBU 1M25G	1788210000
M 25	with thread		76	HDC 40D TOBU 1M25G	1787070000
M 32	with thread		76	HDC 40D TOBU 1M32G	1787060000

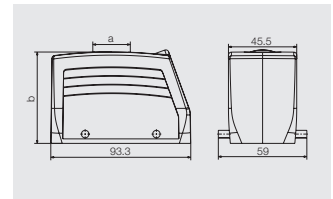

Cover



Version	Designation	Order No.
for hoods	HDC 16B DMDQ 2QB	1665270000

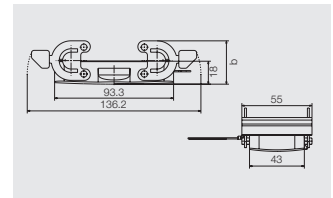

Base

Bulkhead housing



Version	Cover	b (mm)	Designation	Order No.
		29	HDC 16B ABU	1208600000

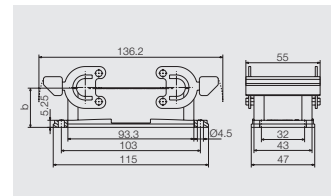

Base housing



a	Version	Cover	b (mm)	Designation	Order No.
M 25	with thread		64	HDC 16B SBU 2M25G	1788240000
M 25	with thread		84	HDC 40D SBU 2M25G	1787120000
M 32	with thread		84	HDC 40D SBU 2M32G	1787110000

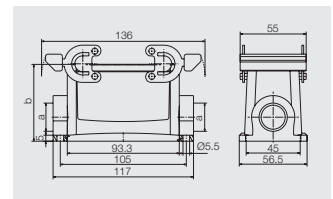

Coupling hood



a	Version	Cover	b (mm)	Designation	Order No.
M 25	with thread		79	HDC 40D KBU 1M25G	1787200000
M 32	with thread		79	HDC 40D KBU 1M32G	1787190000

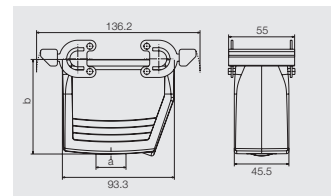

Cover



Version	Designation	Order No.
for bases	HDC 16B DODQ 4BO	1665260000

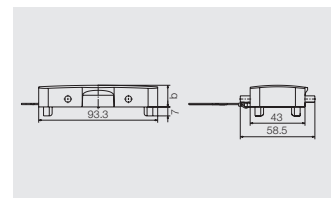

HDD series - the compact connectors

250 V, 10 A, Size 8

108 + ⊕



Inserts

Crimp connection



Insert	Designation	Order No.
Male	HDC HDD 108 MC	1651210000
Female	HDC HDD 108 FC	1651220000

Dimensions

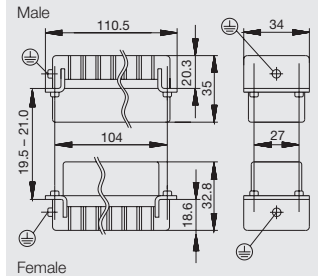

Arrangement of contacts

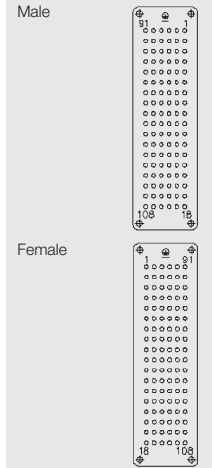

Mounting cut-out

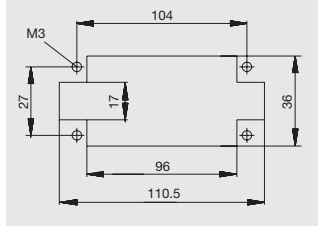

Accessories

Crimp contacts

Surface silver



Surface gold



Qty.	Male	Order No.	Female	Order No.
100	HDC-C-HD-SM0.14-0.37AG	1651520000	HDC-C-HD-BM0.14-0.37AG	1651570000
100	HDC-C-HD-SM0.5AG	1651530000	HDC-C-HD-BM0.5AG	1651580000
100	HDC-C-HD-SM0.75-1AG	1601750000	HDC-C-HD-BM0.75-1AG	1601760000
100	HDC-C-HD-SM1.5AG	1651550000	HDC-C-HD-BM1.5AG	1651600000
100	HDC-C-HD-SM2.5AG	1651560000	HDC-C-HD-BM2.5AG	1651610000
100	HDC-C-HD-SM0.14-0.37AU	1651620000	HDC-C-HD-BM0.14-0.37AU	1651670000
100	HDC-C-HD-SM0.5AU	1651630000	HDC-C-HD-BM0.5AU	1651680000
100	HDC-C-HD-SM0.75-1AU	1651640000	HDC-C-HD-BM0.75-1AU	1651690000
100	HDC-C-HD-SM1.5AU	1651650000	HDC-C-HD-BM1.5AU	1651700000
100	HDC-C-HD-SM2.5AU	1651660000	HDC-C-HD-BM2.5AU	1651710000



Single contacts

Conductor mm ²	AWG No.
0.14 - 0.37	22
0.50	20
0.75 - 1.00	18
1.50	16
2.50	14

Tools



Tool	Order No.
Crimping tool CTX CM 1.6/2.5	9018490000
Contact removal tool Removal Tool HD	1866730000

Selection of Housings RockStar® IP65
Size 8



Hood

Hood, Cable Entry sideways



a	Version	Cover	b (mm)	Designation	Order No.
M 25	with thread		61	HDC 24B TSBU 1M25G	1787760000
M 32	with thread		61	HDC 24B TSBU 1M32G	1787750000
M 25	with thread		76	HDC 64D TSBU 1M25G	1786780000
M 32	with thread		76	HDC 64D TSBU 1M32G	1786770000

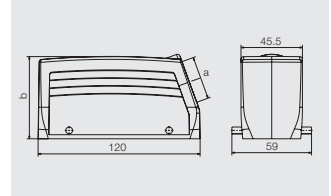

Hood, Cable Entry at top



a	Version	Cover	b (mm)	Designation	Order No.
M 25	with thread		61	HDC 24B TOBU 1M25G	1787820000
M 32	with thread		61	HDC 24B TOBU 1M32G	1787810000
M 32	with thread		76	HDC 64D TOBU 1M32G	1786830000

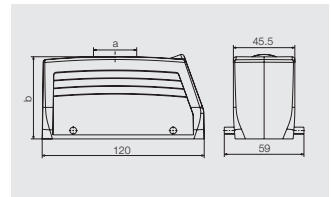

Cover

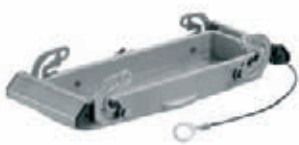

Version	Designation	Order No.
for hoods	HDC 24B DMDQ 2QB	1665640000

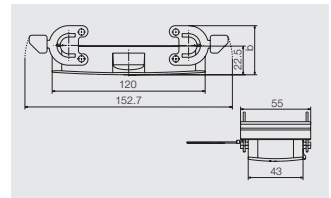

Base

Bulkhead housing



Version	Cover	b (mm)	Designation	Order No.
		29.3	HDC 24B ABU	1212400000

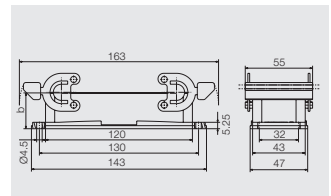

Base housing



a	Version	Cover	b (mm)	Designation	Order No.
M 25	with thread		64	HDC 24B SBU 2M25G	1787870000
M 25	with thread		84	HDC 64D SBU 2M25G	1786890000
M 32	with thread		84	HDC 64D SBU 2M32G	1786880000

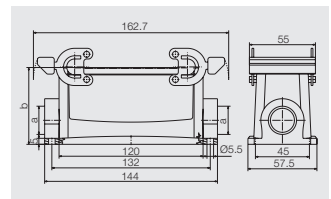

Coupling hood



a	Version	Cover	b (mm)	Designation	Order No.
M 25	with thread		65	HDC 24B KBU 1M25G	1787920000
M 32	with thread		79	HDC 64D KBU 1M32G	1786960000

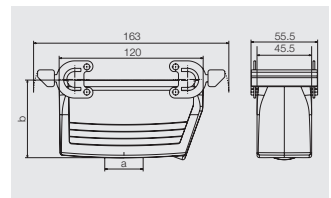

Cover



Version	Designation	Order No.
for bases	HDC 24B DODQ 4BO	1665630000

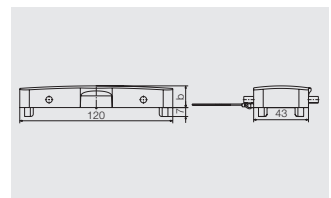

HDD series - the compact connectors

250 V, 10 A, Size 10

144 + ⊕

Inserts



Crimp connection

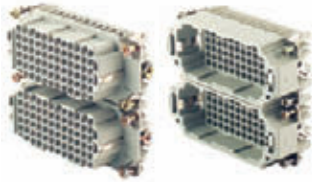

Insert	Designation	Order No.
Male	HDC HDD 72 MC	1651190000
Female	HDC HDD 72 FC	1651200000
Male	HDC HDD 144 MC	1651240000
Female	HDC HDD 144 FC	1651260000

Note Please order two contact inserts per housing.

Dimensions

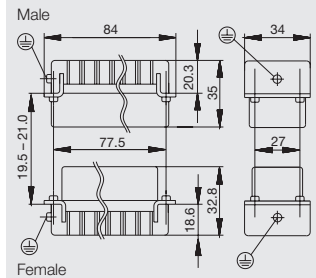

Arrangement of contacts

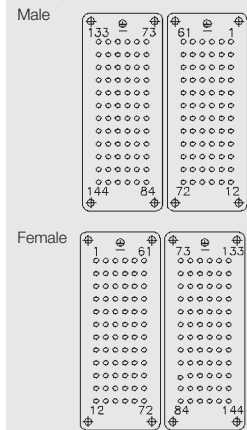

Mounting cut-out

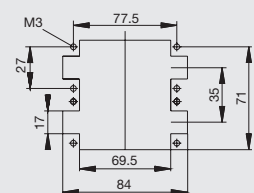

Accessories

Crimp contacts

Surface silver



Surface gold



Qty.	Male	Order No.	Female	Order No.
100	HDC-C-HD-SM0.14-0.37AG	1651520000	HDC-C-HD-BM0.14-0.37AG	1651570000
100	HDC-C-HD-SM0.5AG	1651530000	HDC-C-HD-BM0.5AG	1651580000
100	HDC-C-HD-SM0.75-1AG	1601750000	HDC-C-HD-BM0.75-1AG	1601760000
100	HDC-C-HD-SM1.5AG	1651550000	HDC-C-HD-BM1.5AG	1651600000
100	HDC-C-HD-SM2.5AG	1651560000	HDC-C-HD-BM2.5AG	1651610000
100	HDC-C-HD-SM0.14-0.37AU	1651620000	HDC-C-HD-BM0.14-0.37AU	1651670000
100	HDC-C-HD-SM0.5AU	1651630000	HDC-C-HD-BM0.5AU	1651680000
100	HDC-C-HD-SM0.75-1AU	1651640000	HDC-C-HD-BM0.75-1AU	1651690000
100	HDC-C-HD-SM1.5AU	1651650000	HDC-C-HD-BM1.5AU	1651700000
100	HDC-C-HD-SM2.5AU	1651660000	HDC-C-HD-BM2.5AU	1651710000

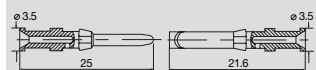

Single contacts

Conductor mm ²	AWG No.
0.14 - 0.37	22
0.50	20
0.75 - 1.00	18
1.50	16
2.50	14

Tools



Tool	Order No.
Crimping tool CTX CM 1.6/2.5	9018490000
Contact removal tool Removal Tool HD	1866730000

Selection of Housings RockStar® IP65
Size 10



Hood

Hood, Cable Entry sideways



a	Version	Cover	b (mm)	Designation	Order No.
M 32	with thread		79	HDC 32B TSLU 1M32G	1788420000

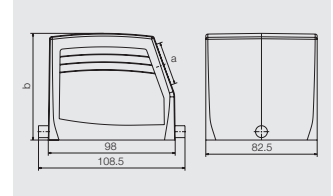

Base

Bulkhead housing



Version	Cover	b (mm)	Designation	Order No.
	with cover	55	HDC 32B ADLU	1219800000
		38	HDC 32B ALU	1219500000

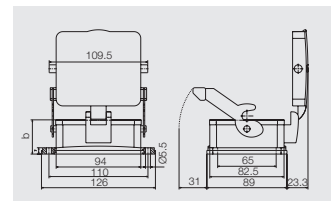

Base housing



a	Version	Cover	b (mm)	Designation	Order No.
M 32	with thread	with cover	96	HDC 32B SDLU 2M32G	1788490000
M 32	with thread		79	HDC 32B SLU 2M32G	1788470000

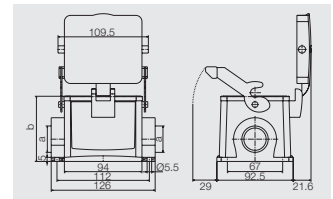

Coupling hood



a	Version	Cover	b (mm)	Designation	Order No.
M 32	with thread		83	HDC 32B KLU 1M32G	1788500000

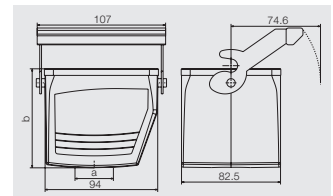

HDD series - the compact connectors

250 V, 10 A, Size 12

216 + ⊕

Inserts



Crimp connection



Insert	Designation	Order No.
Male	HDC HDD 108 MC	1651210000
Female	HDC HDD 108 FC	1651220000
Male	HDC HDD 216 MC	1651280000
Female	HDC HDD 216 FC	1651300000

Note Please order two contact inserts per housing.

Dimensions

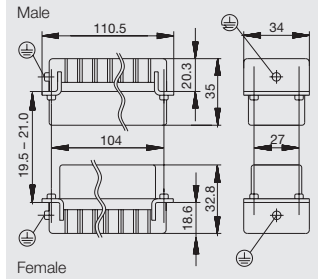

Arrangement of contacts

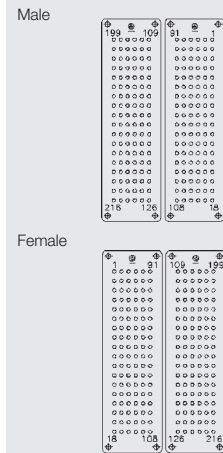

Mounting cut-out

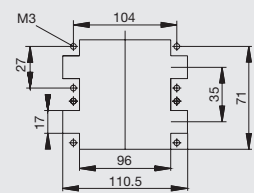

Accessories

Crimp contacts

Surface silver



Surface gold



Qty.	Male	Order No.	Female	Order No.
100	HDC-C-HD-SM0.14-0.37AG	1651520000	HDC-C-HD-BM0.14-0.37AG	1651570000
100	HDC-C-HD-SM0.5AG	1651530000	HDC-C-HD-BM0.5AG	1651580000
100	HDC-C-HD-SM0.75-1AG	1601750000	HDC-C-HD-BM0.75-1AG	1601760000
100	HDC-C-HD-SM1.5AG	1651550000	HDC-C-HD-BM1.5AG	1651600000
100	HDC-C-HD-SM2.5AG	1651560000	HDC-C-HD-BM2.5AG	1651610000
100	HDC-C-HD-SM0.14-0.37AU	1651620000	HDC-C-HD-BM0.14-0.37AU	1651670000
100	HDC-C-HD-SM0.5AU	1651630000	HDC-C-HD-BM0.5AU	1651680000
100	HDC-C-HD-SM0.75-1AU	1651640000	HDC-C-HD-BM0.75-1AU	1651690000
100	HDC-C-HD-SM1.5AU	1651650000	HDC-C-HD-BM1.5AU	1651700000
100	HDC-C-HD-SM2.5AU	1651660000	HDC-C-HD-BM2.5AU	1651710000



Single contacts

Conductor mm ²	AWG No.
0.14 - 0.37	22
0.50	20
0.75 - 1.00	18
1.50	16
2.50	14

Tools



Tool	Order No.
Crimping tool CTX CM 1.6/2.5	9018490000
Contact removal tool Removal Tool HD	1866730000

Selection of Housings RockStar® IP65
Size 12



Hood

Hood, Cable Entry sideways



a	Version	Cover	b (mm)	Designation	Order No.
M 32	with thread		94	HDC 48B TSLU 1M32G	1788320000
M 40	with thread		94	HDC 48B TSLU 1M40G	1788310000
M 50	with thread		94	HDC 48B TSLU 1M50G	1788300000

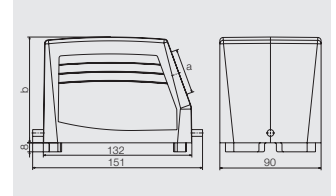

Hood, Cable Entry at top



a	Version	Cover	b (mm)	Designation	Order No.
M 32	with thread		94	HDC 48B TOLU 1M32G	1788350000
M 50	with thread		94	HDC 48B TOLU 1M50G	1788330000

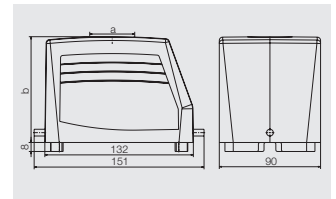

Base

Bulkhead housing



Version	Cover	b (mm)	Designation	Order No.
	with cover	62	HDC 48B ADLU	1222900000

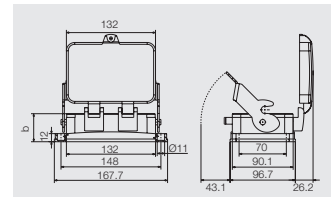

Base housing

a	Version	Cover	b (mm)	Designation	Order No.
M 32	with thread	with cover	120	HDC 48B SDLU 2M32G	1788390000
M 32	with thread		100	HDC 48B SLU 2M32G	1788370000
M 40	with thread		100	HDC 48B SLU 2M40G	1788360000

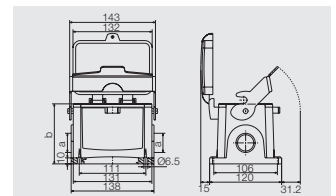

HVE series – exciting voltage

Weidmüller high-voltage inserts are equipped with lagging earth contacts. This means that plugging operations are never performed live, protecting the user and the circuit.

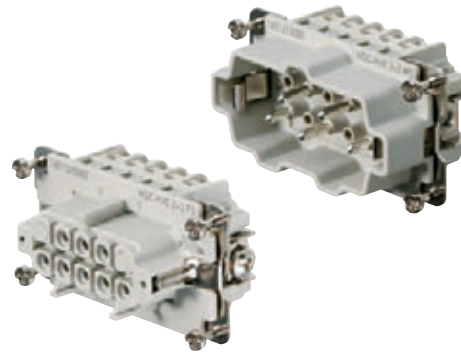

Technical data





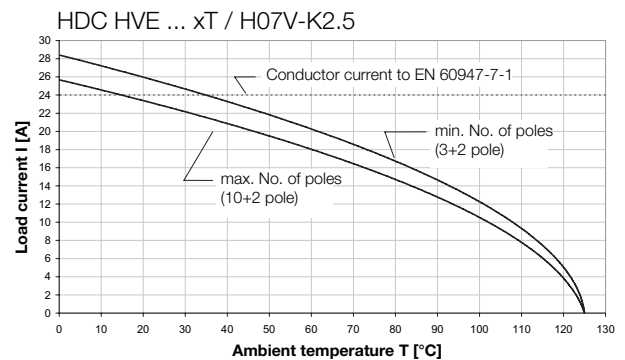
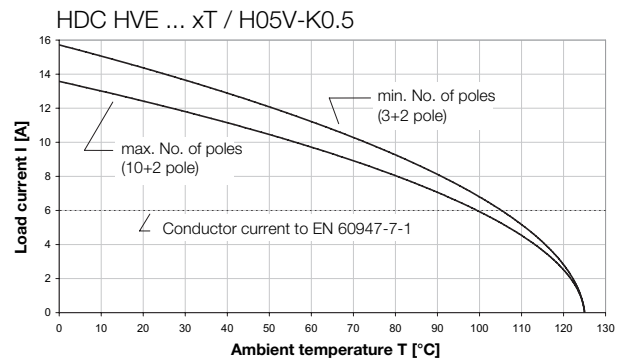

Standards / approvals	
Standards	DIN EN 61984 DIN EN 60664-1
Approvals	UL/CSA
Inserts	
No. of poles	3 + 2, 6 + 2, 10 + 2
Rated voltage	830 V
Rated voltage to UL/CSA	600 V
Rated current	23 A (HV 3+2 = 24 A)
Rated impulse withstand voltage	8 kV
Pollution severity	3
Insulation resistance	$\geq 10^{10} \Omega$
Material	Glass-fibre reinforced PC (in UL list and approved for railway applications)
Temperature range	-40 °C ... +125 °C
Flammability to UL 94	V-0
Mechanical service life	
- Plugging cycles Ag - Surface	≥ 500
Contacts / Material	
Sockets and plug-in contact	Copper alloy
Surface	Passivated silver
Clamping unit / Screw connection	Copper alloy / Passivated silver
Clamping range / Stripping length	
- Screw connection	0.5 - 2.5 mm ² (AWG 20 ... 14) / 9 mm
- Tension clamp connection	0.5 - 2.5 mm ² (AWG 20 ... 14) / 8 mm
Clamping torque	
- Screw connection	0.5 - 0.55 Nm
SD blades	
- Screw connection	0.6 x 3.5 or PZ 0
- Tension clamp connection	0.5 x 3 or 0.6 x 3.5
PE connection	
- Clamping range	0.5 ... 4 mm ²
- solid / stranded	0.5 ... 4 mm ² / 0.5 ... 4 mm ²
- flexible / flexible with wire end ferrule, DIN 46228 pt. 1	0.5 ... 4 mm ² / 0.5 ... 4 mm ²
- AWG conductor	AWG 20 ... 12
- Stripping length	10 mm
- Clamping torque	1.2 ... 1.5 Nm
- Blade dimensions	SD 0.8 x 4 mm or PZ 1

Note: Switch off power supply before handling plug-in connectors.
Rated voltage determined on the basis of DIN EN 61984 section 6.19.2.2.
500 V for signal contact.

Derating curves



Overview

		Rated voltage	Rated current	No. of poles	Tension clamp connection	Screw conn. with wire guard spring	Crimp connection	Push In	Axial screw connection	Page
		830 V	24 A	3 + 2 + ⊕	•	•				B.80
		830 V	23 A	6 + 2 + ⊕	•	•				B.82
		830 V	23 A	10 + 2 + ⊕	•	•				B.84

HVE series - exciting voltage

830 V, 24 A, Size 4

3+2 + ⊕

Inserts



Tension clamp connection



Insert	Designation	Order No.
Male	HDC HVE 3+2 MT	1896930000
Female	HDC HVE 3+2 FT	1896920000

Screw connection



Insert	Designation	Order No.
Male	HDC HVE 3+2 MS	1651310000
Female	HDC HVE 3+2 FS	1651320000

Dimensions

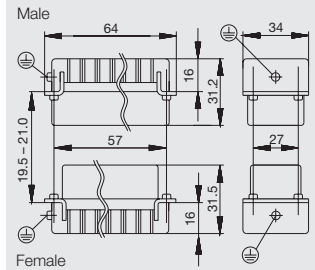

Arrangement of contacts

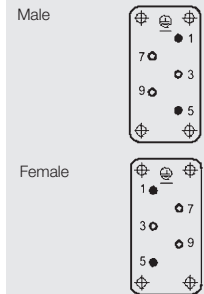

Mounting cut-out

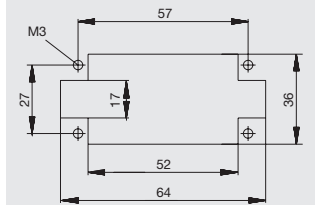

Selection of Housings RockStar® IP65
Size 4



Hood

Hood, Cable Entry sideways



a	Version	Cover	b (mm)	Designation	Order No.
M 20	with thread		52	HDC 10B TSBU 1M20G	1787560000
M 25	with thread		52	HDC 10B TSBU 1M25G	1787550000
M 25	with thread		72	HDC 24D TSBU 1M25G	1787240000
M 32	with thread		72	HDC 24D TSBU 1M32G	1787230000

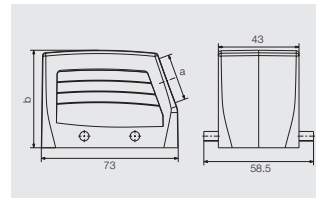

Hood, Cable Entry at top



a	Version	Cover	b (mm)	Designation	Order No.
M 20	with thread		52	HDC 10B TOBU 1M20G	1787600000
M 25	with thread		52	HDC 10B TOBU 1M25G	1787590000
M 25	with thread		72	HDC 24D TOBU 1M25G	1787300000
M 32	with thread		72	HDC 24D TOBU 1M32G	1787290000

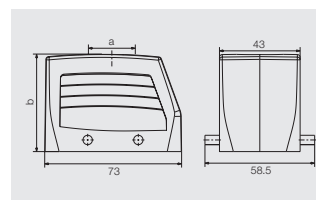

Cover



Version	Designation	Order No.
for hoods	HDC 10B DMDQ 2QB	1665240000

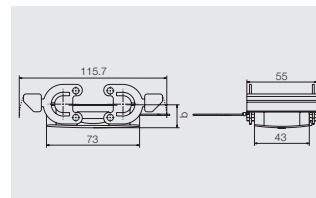

Base

Bulkhead housing



Version	Cover	b (mm)	Designation	Order No.
		29.3	HDC 10B ABU	1205000000

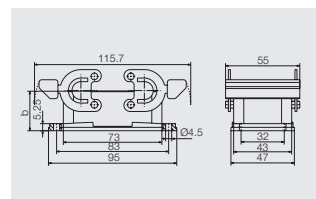

Base housing



a	Version	Cover	b (mm)	Designation	Order No.
M 20	with thread		57	HDC 10B SBU 2M20G	1787640000
M 25	with thread		57	HDC 10B SBU 2M25G	1787630000
M 25	with thread		74	HDC 24D SBU 2M25G	1787350000
M 32	with thread		74	HDC 24D SBU 2M32G	1787360000

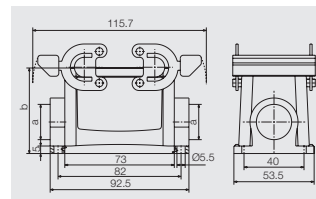

Coupling hood



a	Version	Cover	b (mm)	Designation	Order No.
M 20	with thread		55	HDC 10B KBU 1M20G	1787720000

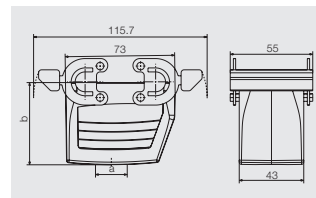

Cover



Version	Designation	Order No.
for bases	HDC 10B DODQ 4BO	1665230000

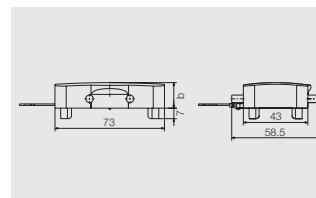

HVE series - exciting voltage

830 V, 23 A, Size 6

6+2 + ⊕



Inserts

Tension clamp connection



Insert	Designation	Order No.
Male	HDC HVE 6+2 MT	1896950000
Female	HDC HVE 6+2 FT	1896940000

Screw connection



Insert	Designation	Order No.
Male	HDC HVE 6+2 MS	1651330000
Female	HDC HVE 6+2 FS	1651340000

Dimensions

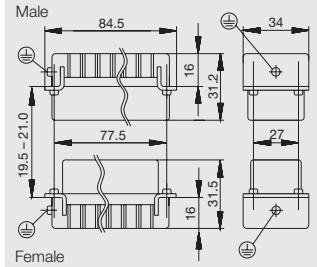

Arrangement of contacts

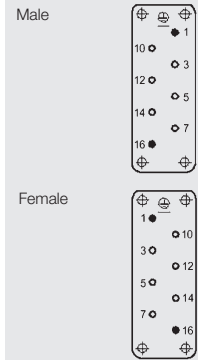

Mounting cut-out

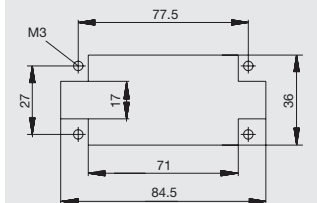

Selection of Housings RockStar® IP65
Size 6



Hood

Hood, Cable Entry sideways



a	Version	Cover	b (mm)	Designation	Order No.
M 25	with thread		61	HDC 16B TSBU 1M25G	1788180000
M 25	with thread		76	HDC 40D TSBU 1M25G	1787010000
M 32	with thread		76	HDC 40D TSBU 1M32G	1787000000

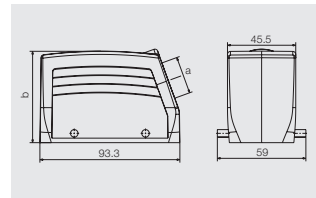

Hood, Cable Entry at top



a	Version	Cover	b (mm)	Designation	Order No.
M 25	with thread		61	HDC 16B TOBU 1M25G	1788210000
M 25	with thread		76	HDC 40D TOBU 1M25G	1787070000
M 32	with thread		76	HDC 40D TOBU 1M32G	1787060000

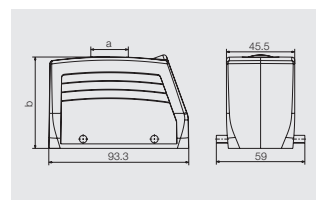

Cover



Version	Designation	Order No.
for hoods	HDC 16B DMDQ 2QB	1665270000

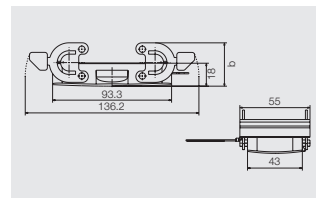

Base

Bulkhead housing



Version	Cover	b (mm)	Designation	Order No.
		29	HDC 16B ABU	1208600000

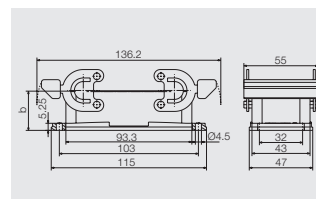

Base housing



a	Version	Cover	b (mm)	Designation	Order No.
M 25	with thread		64	HDC 16B SBU 2M25G	1788240000
M 25	with thread		84	HDC 40D SBU 2M25G	1787120000
M 32	with thread		84	HDC 40D SBU 2M32G	1787110000

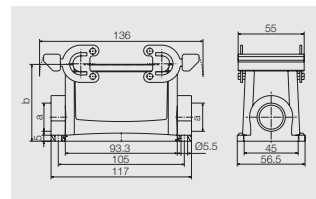

Coupling hood



a	Version	Cover	b (mm)	Designation	Order No.
M 25	with thread		79	HDC 40D KBU 1M25G	1787200000
M 32	with thread		79	HDC 40D KBU 1M32G	1787190000

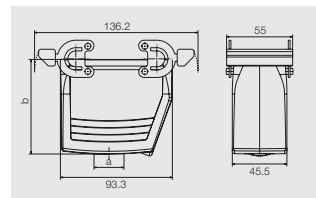

Cover



Version	Designation	Order No.
for bases	HDC 16B DODQ 4BO	1665260000

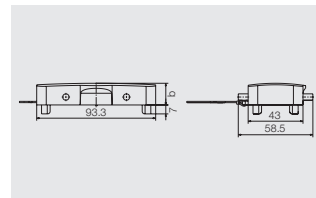

HVE series - exciting voltage

830 V, 23 A, Size 8

10+2 + ⊕



Inserts

Tension clamp connection



Insert	Designation	Order No.
Male	HDC HVE 10+2 MT	1896970000
Female	HDC HVE 10+2 FT	1896960000

Screw connection



Insert	Designation	Order No.
Male	HDC HVE 10+2 MS	1651350000
Female	HDC HVE 10+2 FS	1651360000

Dimensions

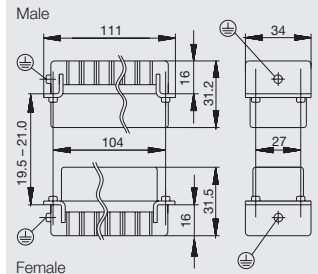

Arrangement of contacts

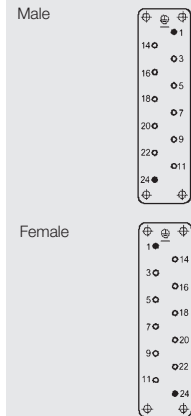

Mounting cut-out

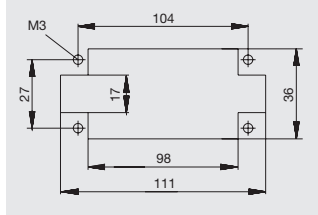

Selection of Housings RockStar® IP65
Size 8



Hood

Hood, Cable Entry sideways



a	Version	Cover	b (mm)	Designation	Order No.
M 25	with thread		61	HDC 24B TSBU 1M25G	1787760000
M 32	with thread		61	HDC 24B TSBU 1M32G	1787750000
M 25	with thread		76	HDC 64D TSBU 1M25G	1786780000
M 32	with thread		76	HDC 64D TSBU 1M32G	1786770000

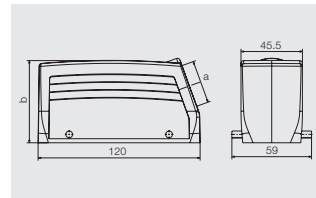

Hood, Cable Entry at top



a	Version	Cover	b (mm)	Designation	Order No.
M 25	with thread		61	HDC 24B TOBU 1M25G	1787820000
M 32	with thread		61	HDC 24B TOBU 1M32G	1787810000
M 32	with thread		76	HDC 64D TOBU 1M32G	1786830000

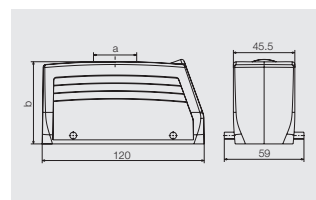

Cover

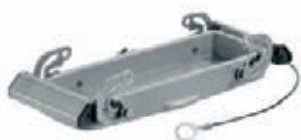

Version	Designation	Order No.
for hoods	HDC 24B DMDQ 2QB	1665640000

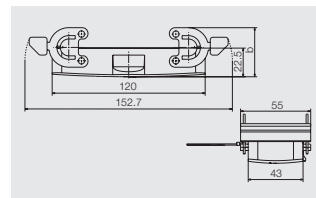

Base

Bulkhead housing



Version	Cover	b (mm)	Designation	Order No.
		29.3	HDC 24B ABU	1212400000

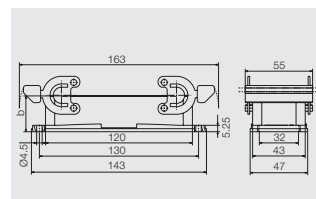

Base housing



a	Version	Cover	b (mm)	Designation	Order No.
M 25	with thread		64	HDC 24B SBU 2M25G	1787870000
M 25	with thread		84	HDC 64D SBU 2M25G	1786890000
M 32	with thread		84	HDC 64D SBU 2M32G	1786880000

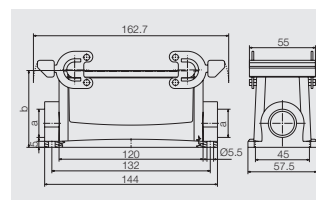

Coupling hood



a	Version	Cover	b (mm)	Designation	Order No.
M 25	with thread		65	HDC 24B KBU 1M25G	1787920000
M 32	with thread		79	HDC 64D KBU 1M32G	1786960000

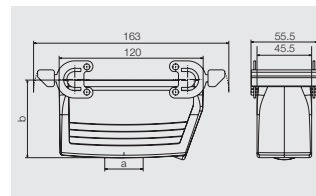

Cover



Version	Designation	Order No.
for bases	HDC 24B DODQ 4BO	1665630000

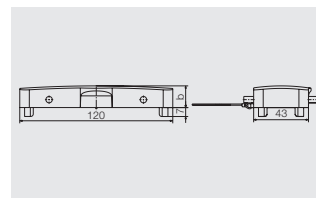

HSB series – the heavy-duty connectors

The HSB series provides users with 35 A via each contact with screw connections for a safe and reliable connection.

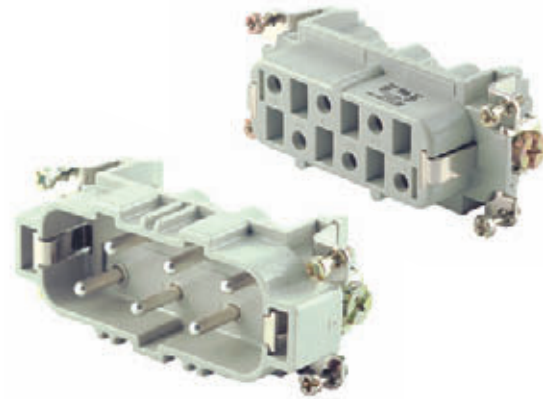

Technical data



Standards / approvals	
Standards	DIN EN 61984 DIN EN 60664-1
Approvals	UL/CSA
Inserts	
No. of poles	6, 12
Rated voltage	400 V
Rated voltage to UL/CSA	600 V
Rated current	35 A
Rated impulse withstand voltage	6 kV
Pollution severity	3
Insulation resistance	$\geq 10^{10} \Omega$
Material	Glass-fibre reinforced PC (in UL list and approved for railway applications)
Temperature range	-40 °C ... +125 °C
Flammability to UL 94	V-0
Mechanical service life	
- Plugging cycles Ag - Surface	≥ 500
- Plugging cycles Au - Surface	≥ 500
Contact resistance	
Screw connection	$\leq 2 \text{ m}\Omega$
Contacts / Material	
Sockets and plug-in contact	Copper alloy
Surface	Passivated silver or 0.8 μm gold on 2 μm Ni
Clamping unit / Screw connection	Copper alloy / Passivated silver
Screw connection	
- Clamping range	0.5 – 6 mm ² (AWG 20 ... 10)
- Stripping length	11 mm
- flex. with wire end ferrule to DIN 46228 Part 1:	4 mm ²
Clamping torque	
- Screw connection	1.2 ... 1.5 Nm
SD blades	0.6 x 3.5 or 0.8 x 4 mm
PE connection	
- Clamping range	0.5 ... 6 mm ²
- solid / stranded	0.5 ... 6 mm ² / 0.5 ... 6 mm ²
- flexible / flexible with wire end ferrule, DIN 46228 pt. 1	0.5 ... 6 mm ² / 0.5 ... 6 mm ²
- AWG conductor	AWG 20 .. 12
- Stripping length	10 mm
- Clamping torque	2 ... 2.5 Nm
- Blade dimensions	SD 1 x 5.5 mm or PH 2

Note: Switch off power supply before handling plug-in connectors.
When connecting flexible conductors using screws, wire end ferrules to DIN 46228 Part 1 must be used.

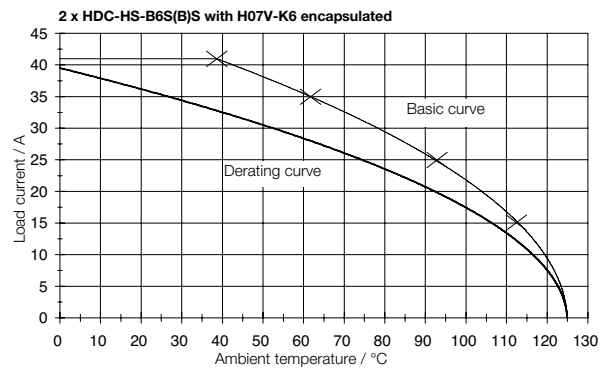
Derating curves



Overview

	Rated voltage	Rated current	No. of poles	Tension clamp connection	Screw conn. with wire guard spring	Crimp connection	Push In	Axial screw connection	Page
	400 V	35 A	6 + ⊕		•				B.88
	400 V	35 A	12 + ⊕		•				B.90

HSB series - the heavy-duty connectors

400 V, 35 A, Size 6

6 + ⊕

Inserts



Screw connection



Insert	Designation	Order No.
Male	HDC HSB 6 MS	1498700000
Female	HDC HSB 6 FS	1498900000

Dimensions

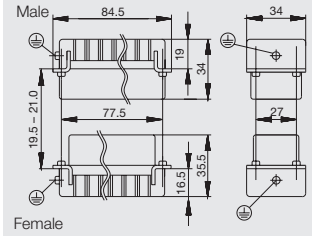

Arrangement of contacts

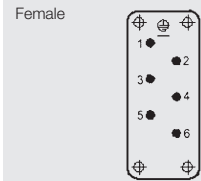
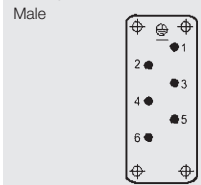

Mounting cut-out

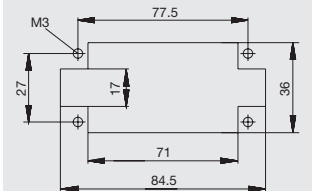

**Selection of Housings RockStar® IP65
Size 6**



Hood

Hood, Cable Entry sideways



a	Version	Cover	b (mm)	Designation	Order No.
M 25	with thread		61	HDC 16B TSBU 1M25G	1788180000
M 25	with thread		76	HDC 40D TSBU 1M25G	1787010000
M 32	with thread		76	HDC 40D TSBU 1M32G	1787000000

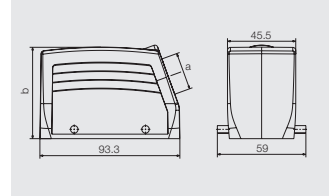

Hood, Cable Entry at top



a	Version	Cover	b (mm)	Designation	Order No.
M 25	with thread		61	HDC 16B TOBU 1M25G	1788210000
M 25	with thread		76	HDC 40D TOBU 1M25G	1787070000
M 32	with thread		76	HDC 40D TOBU 1M32G	1787060000

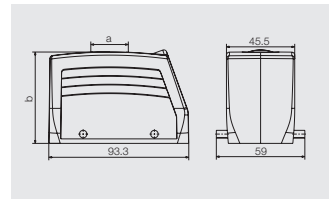

Cover

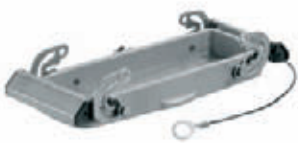

Version	Designation	Order No.
for hoods	HDC 16B DMDQ 2QB	1665270000

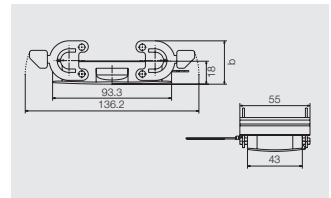

Base

Bulkhead housing



Version	Cover	b (mm)	Designation	Order No.
		29	HDC 16B ABU	1208600000

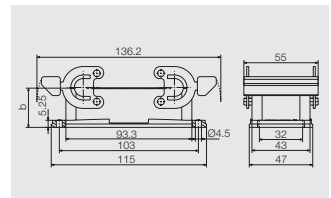

Base housing



a	Version	Cover	b (mm)	Designation	Order No.
M 25	with thread		64	HDC 16B SBU 2M25G	1788240000
M 25	with thread		84	HDC 40D SBU 2M25G	1787120000
M 32	with thread		84	HDC 40D SBU 2M32G	1787110000

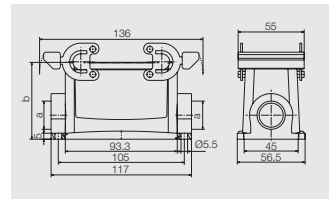

Coupling hood



a	Version	Cover	b (mm)	Designation	Order No.
M 25	with thread		79	HDC 40D KBU 1M25G	1787200000
M 32	with thread		79	HDC 40D KBU 1M32G	1787190000

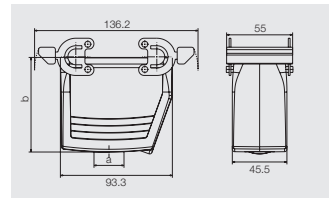

Cover



Version	Designation	Order No.
for bases	HDC 16B DODQ 4BO	1665260000

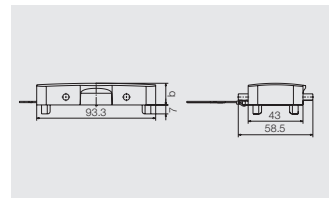

HSB series - the heavy-duty connectors

400 V, 35 A, Size 10

12 + ⊕

Inserts

Screw connection



Insert	Designation	Order No.
Male	HDC HSB 6 MS	1498700000
Female	HDC HSB 6 FS	1498900000
Male	HDC HSB 6 MS 7 - 12	1498800000
Female	HDC HSB 6 FS 7 - 12	1499000000



Dimensions

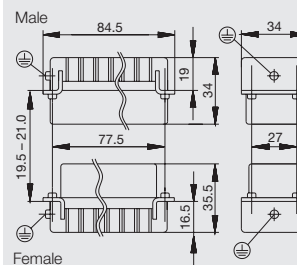

Arrangement of contacts

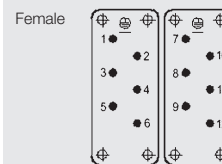
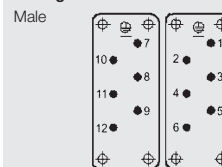

Mounting cut-out

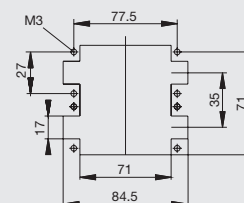

Selection of Housings RockStar® IP65
Size 10



Hood

Hood, Cable Entry sideways



a	Version	Cover	b (mm)	Designation	Order No.
M 32	with thread		79	HDC 32B TSLU 1M32G	1788420000

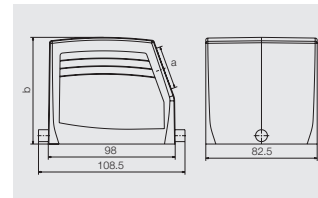

Base

Bulkhead housing



Version	Cover	b (mm)	Designation	Order No.
	with cover	55	HDC 32B ADLU	1219800000
		38	HDC 32B ALU	1219500000

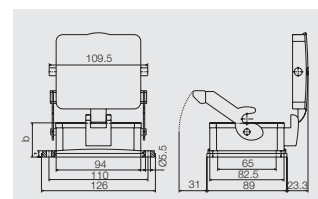

Base housing



a	Version	Cover	b (mm)	Designation	Order No.
M 32	with thread	with cover	96	HDC 32B SDLU 2M32G	1788490000
M 32	with thread		79	HDC 32B SLU 2M32G	1788470000

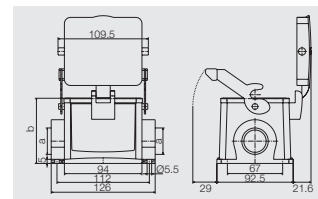

Coupling hood



a	Version	Cover	b (mm)	Designation	Order No.
M 32	with thread		83	HDC 32B KLU 1M32G	1788500000

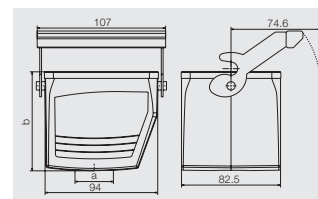

MixMate series – the high-capacity connectors

MixMate integrates axial screw contacts and TOP connection technology in one plug-in connector. The compact design allows simultaneous transmission of high currents, high voltages and signals.







Technical data

	S 4	S 4/0	S 6/12	S 6/6
Standards / approvals				
Standards	DIN EN 61984 DIN EN 60664-1	DIN EN 61984 DIN EN 60664-1	DIN EN 61984 DIN EN 60664-1	DIN EN 61984 DIN EN 60664-1
Approvals	UL/CSA	UL/CSA	UL/CSA	UL/CSA
Inserts				
No. of poles				
– Power contact	4 (+PE)	4	6	6 (+PE)
– Signal contact			12	6
Rated voltage				
– Power contact	1000 V	830 V	630 V	630 V
– Signal contact			400 V	400 V
Rated voltage to UL/CSA	600 V	600 V	600 V	600 V
Rated current				
– Power contact	65 A	80 A	48 A	100 A
– Signal contact			16 A	16 A
Rated impulse withstand voltage				
– Power contact	8 KV	8 KV	8 KV	8 KV
– Signal contact			6 KV	6 KV
Pollution severity	3	3	3	3
Insulation resistance	$\geq 10^{10} \Omega$	$\geq 10^{10} \Omega$	$\geq 10^{10} \Omega$	$\geq 10^{10} \Omega$
Material	Glass-fibre reinforced PC (in UL list and approved for railway applications)	Glass-fibre reinforced PC (in UL list and approved for railway applications)	Glass-fibre reinforced PC (in UL list and approved for railway applications)	Glass-fibre reinforced PC (in UL list and approved for railway applications)
Temperature range	-40 °C ... +125 °C	-40 °C ... +125 °C	-40 °C ... +125 °C	-40 °C ... +125 °C
Flammability to UL 94	V-0	V-0	V-0	V-0
Mechanical service life				
– Plugging cycles Ag - Surface	≥ 500	≥ 500	≥ 500	≥ 500
– Plugging cycles Au - Surface	≥ 500	≥ 500	≥ 500	≥ 500
Contact resistance with min. and max. conductors				
	$\leq 4 \text{ m}\Omega$	$\leq 4 \text{ m}\Omega$	$\leq 4 \text{ m}\Omega$	$\leq 4 \text{ m}\Omega$
Contacts / Material				
Sockets and plug-in contact	Copper alloy	Copper alloy	Copper alloy	Copper alloy
Surface	Passivated silver or 0.8 μm gold on 2 μm Nickel	Passivated silver or 0.8 μm gold on 2 μm Nickel	Passivated silver or 0.8 μm gold on 2 μm Nickel	Passivated silver or 0.8 μm gold on 2 μm Nickel
Flexible conductor connection				
– Power contact	2.5 - 10 mm ² (AWG 14 ... 8)	1.5 - 16 mm ² (AWG 16 ... 6)	2.5 - 10 mm ² (AWG 14 ... 8)	16 - 35 mm ² (AWG 8 ... 2)
– Signal contact			0.5 - 2.5 mm ² (AWG 24 ... 14)	0.5 - 2.5 mm ² (AWG 24 ... 14)
Stripping length				
– Power contact	8 mm	8 mm	8 mm	13 mm
– Signal contact			12 mm	12 mm
Clamping torque/Axial connection				
– Screw connection		2 ... 3 Nm		
– Power contact	1.1 - 1.7 Nm		1.1 - 1.7 Nm	6 ... 8 Nm
– Signal contact			0.45 ... 0.9 Nm	0.45 ... 0.9 Nm
Fixings				
Hexagon socket, 2 mm	SW 2	SW 3	SW 2	SW 4
Screwdriver	0.6 x 3.5		0.6 x 3.5 mm	SD 0.6 x 3.5 or PZ 0
PE connection via plug/socket				
– Clamping range	1.5/2.5 ... 4/10 mm ²	1.5 ... 16 mm ² with cable lug	2.5 ... 10 mm ²	0.5 ... 4 mm ²
– AWG conductor	AWG 16/14 ... 12/8	AWG 16 ... 6	AWG 14 ... 8	AWG 20 ... 12
– Stripping length	8 mm	8 mm (for wire up to 6 mm ² only)	8 mm	8 mm
– Clamping torque	0.5 - 0.8 Nm	2 ... 2.5 Nm	2 ... 2.5 Nm	1.2 - 1.5 mm
– Blade dimensions	SD 0.8 x 4 mm	SD 0.8 x 4 mm or PZ 2	SD 0.8 x 4 mm or PZ 2	SD 0.8 x 4 mm or PZ 1

Note: Power contact = axial connection, Signal contact = screw connection, Switch off power supply before handling plug-in connectors. MixMate S6/6 with PE via axial connection with data identical to the power contact

Overview

	Rated voltage	Rated current	No. of poles	Tension clamp connection	Screw conn. with wire guard spring	Crimp connection	Push In	Axial screw connection	Page
	1000 V	65 A	4 + ⊕					•	B.96
	830 V	80 A	4 + 0 + ⊕					•	B.98
	630 V	48 A	6 + 12 + ⊕		•			•	B.100
	630 V	100 A	6 + 6 + ⊕		•			•	B.102

MixMate series – the high-capacity connectors

Technical data

Derating curves

Size 3
MixMate – 4 power contacts

Size 6
MixMate – 4 power contacts

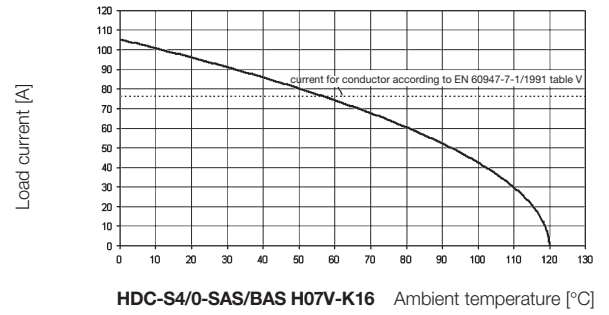
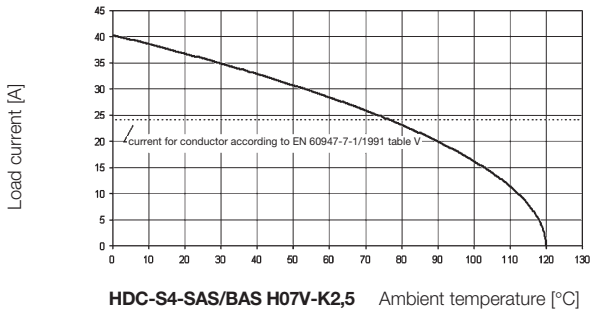
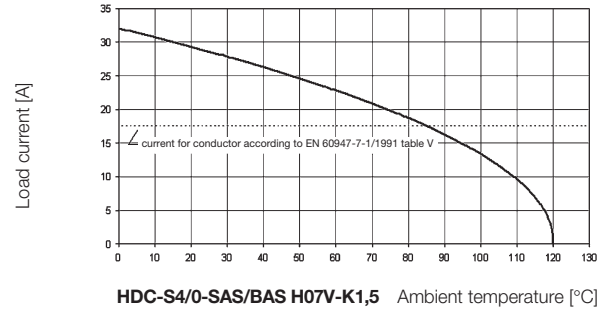
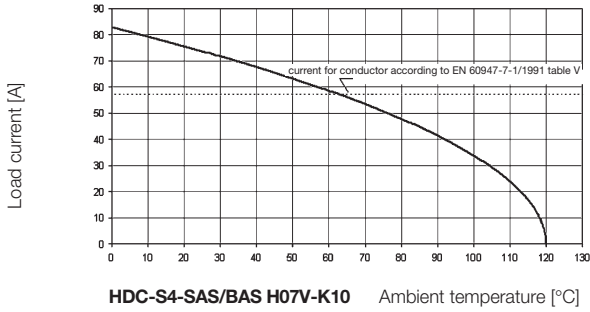

Technical data

Derating curves

Size 6

MixMate – 6 power contacts/12 signal contacts

Size 8

MixMate – 6 power contacts/6 signal contacts

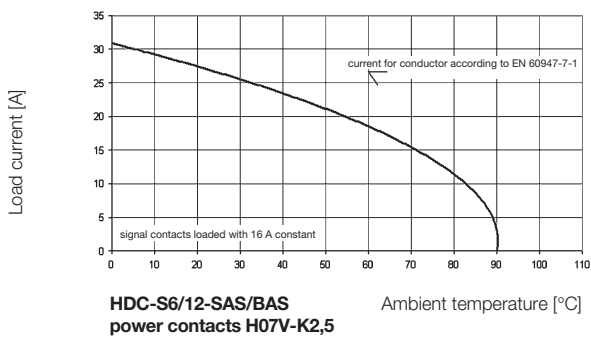
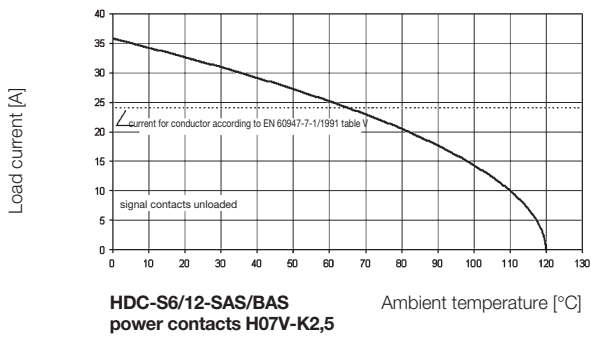
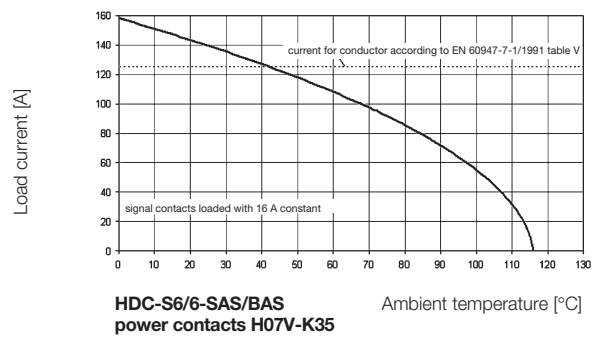
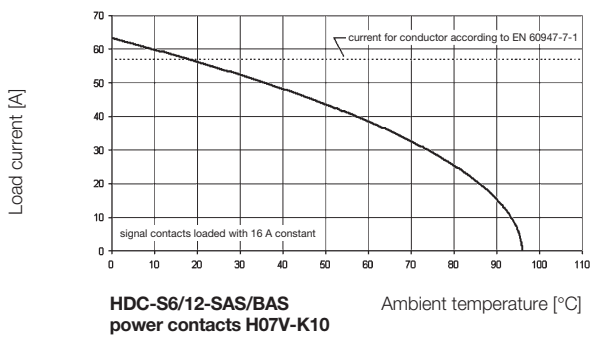
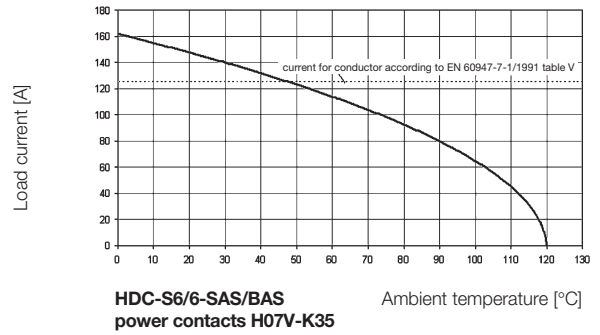
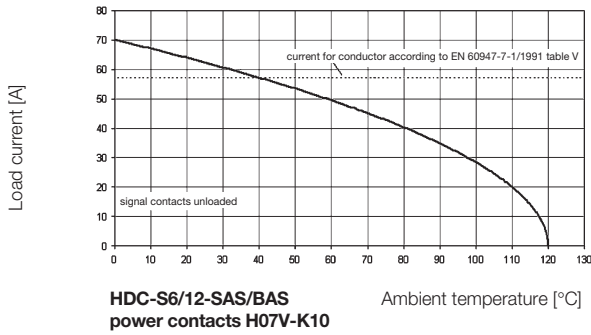

MixMate series - the high-capacity connectors

1000 V, 65 A, Size 3

4 + ⊕

Inserts



Axial screw connection



Insert	Designation	Order No.
Male	HDC S4 SAS	1789990000
Female	HDC S4 BAS	1789980000

Dimensions

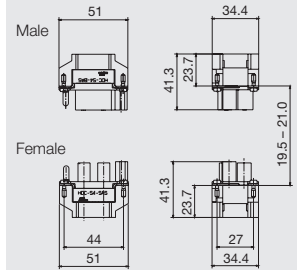

Arrangement of contacts

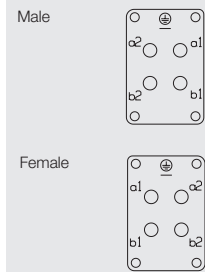

Mounting cut-out

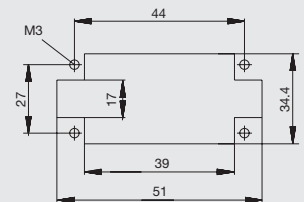

Selection of Housings RockStar® IP65
Size 3



Hood

Hood, Cable Entry sideways



a	Version	Cover	b (mm)	Designation	Order No.
M 20	with thread		52	HDC 06B TSLU 1M20G	1788100000
M 20	with thread		52	HDC 06B TSLU 1M20G	1805930000
M 25	with thread		52	HDC 06B TSLU 1M25G	1788090000
M 25	with thread		72	HDC 16D TSLU 1M25G	1787480000

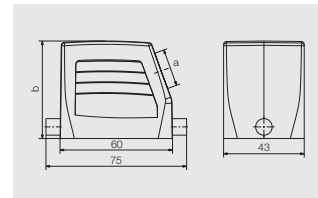

Hood, Cable Entry at top



a	Version	Cover	b (mm)	Designation	Order No.
M 20	with thread		52	HDC 06B TOLU 1M20G	1788120000
M 25	with thread		52	HDC 06B TOLU 1M25G	1788110000
M 25	with thread		72	HDC 16D TOLU 1M25G	1787500000
M 32	with thread		72	HDC 16D TOLU 1M32G	1787490000

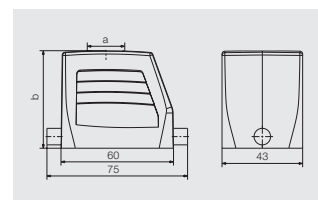

Cover



Version	Designation	Order No.
for hoods	HDC 06B DMDL 1LB	1665210000

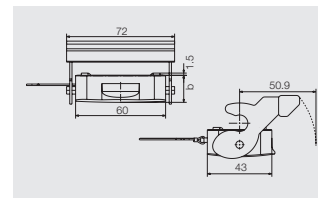

Base

Bulkhead housing



Version	Cover	b (mm)	Designation	Order No.
		29	HDC 06B ALU	1202100000
	with cover	47	HDC 06B ADLU	1202500000

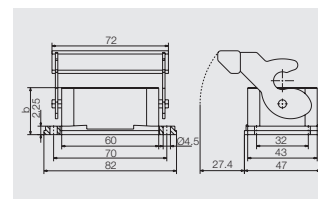

Base housing



a	Version	Cover	b (mm)	Designation	Order No.
M 20	with thread		54	HDC 06B SLU 2M20G	1788140000
M 20	with thread	with cover	72	HDC 06B SDLU 2M20G	1788170000
M 25	with thread		54	HDC 06B SLU 2M25G	1788130000
M 25	with thread	with cover	72	HDC 06B SDLU 2M25G	1788160000

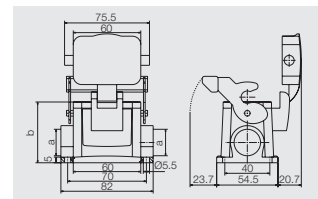

Cover



Version	Designation	Order No.
for bases	HDC 06B DODL 2BO	1665200000

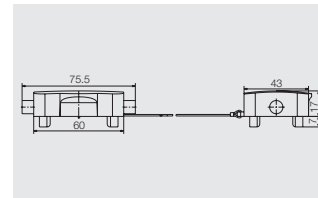

MixMate series - the high-capacity connectors

630 V, 80 A, Size 6

4+0 + ⊕

Inserts



Axial screw connection



Insert	Designation	Order No.
Male	HDC S4 0 SAS	1789960000
Female	HDC S4 0 BAS	1789970000

Dimensions

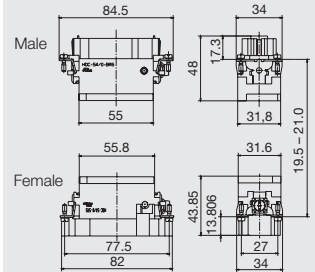

Arrangement of contacts

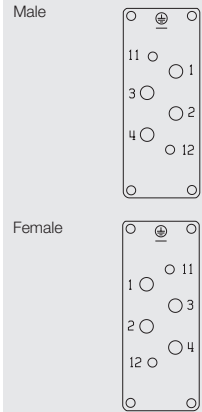

Mounting cut-out

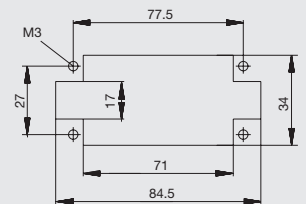

Selection of Housings RockStar® IP65
Size 6



Hood

Hood, Cable Entry sideways



a	Version	Cover	b (mm)	Designation	Order No.
M 25	with thread		61	HDC 16B TSBU 1M25G	1788180000
M 25	with thread		76	HDC 40D TSBU 1M25G	1787010000
M 32	with thread		76	HDC 40D TSBU 1M32G	1787000000

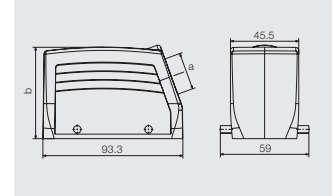

Hood, Cable Entry at top



a	Version	Cover	b (mm)	Designation	Order No.
M 25	with thread		61	HDC 16B TOBU 1M25G	1788210000
M 25	with thread		76	HDC 40D TOBU 1M25G	1787070000
M 32	with thread		76	HDC 40D TOBU 1M32G	1787060000

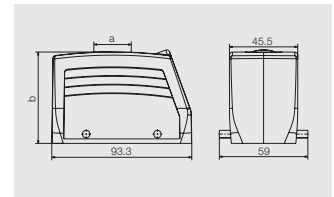

Cover

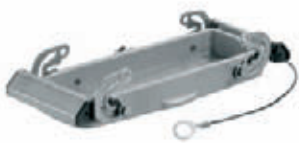

Version	Designation	Order No.
for hoods	HDC 16B DMDQ 2QB	1665270000

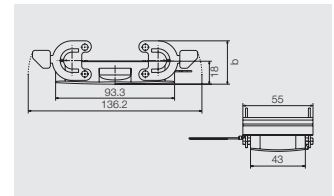

Base

Bulkhead housing



Version	Cover	b (mm)	Designation	Order No.
		29	HDC 16B ABU	1208600000

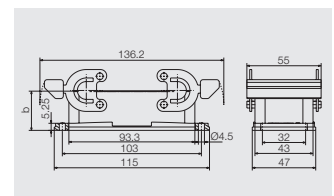

Base housing



a	Version	Cover	b (mm)	Designation	Order No.
M 25	with thread		64	HDC 16B SBU 2M25G	1788240000
M 25	with thread		84	HDC 40D SBU 2M25G	1787120000
M 32	with thread		84	HDC 40D SBU 2M32G	1787110000

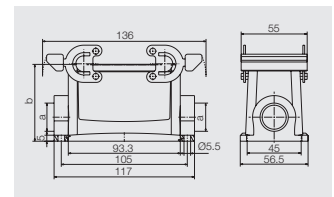

Coupling hood



a	Version	Cover	b (mm)	Designation	Order No.
M 25	with thread		79	HDC 40D KBU 1M25G	1787200000
M 32	with thread		79	HDC 40D KBU 1M32G	1787190000

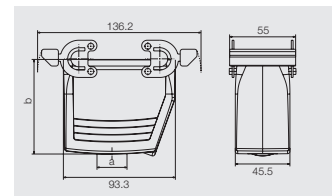

Cover



Version	Designation	Order No.
for bases	HDC 16B DODQ 4BO	1665260000

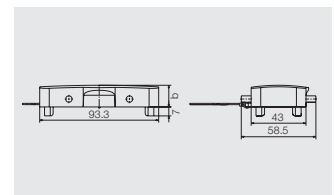

MixMate series - the high-capacity connectors

630 V, 48 A, Size 6

6+12 + ⊕

Inserts



Axial screw connection



Insert	Designation	Order No.
Male	HDC S6 12 SAS	1790000000
Female	HDC S6 12 BAS	1790010000

Note Please note: the signal contacts are designed for a rated voltage of 400V and a rated current of 16A.

Dimensions

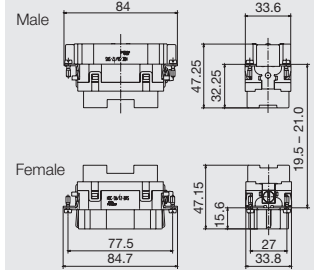

Arrangement of contacts

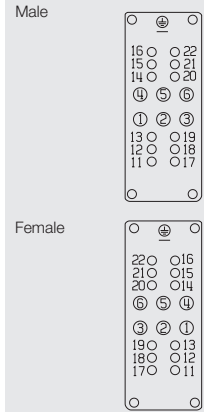

Mounting cut-out

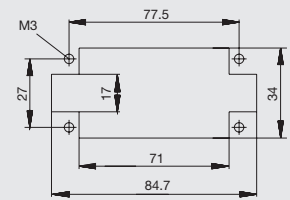

Selection of Housings RockStar® IP65
Size 6



Hood

Hood, Cable Entry sideways



a	Version	Cover	b (mm)	Designation	Order No.
M 25	with thread		61	HDC 16B TSBU 1M25G	1788180000
M 25	with thread		76	HDC 40D TSBU 1M25G	1787010000
M 32	with thread		76	HDC 40D TSBU 1M32G	1787000000

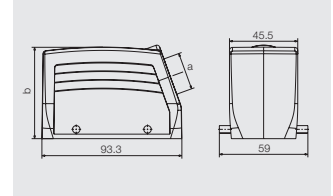

Hood, Cable Entry at top



a	Version	Cover	b (mm)	Designation	Order No.
M 25	with thread		61	HDC 16B TOBU 1M25G	1788210000
M 25	with thread		76	HDC 40D TOBU 1M25G	1787070000
M 32	with thread		76	HDC 40D TOBU 1M32G	1787060000

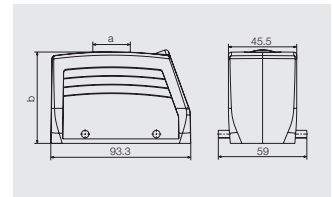

Cover

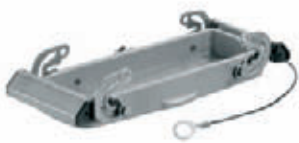

Version	Designation	Order No.
for hoods	HDC 16B DMDQ 2QB	1665270000

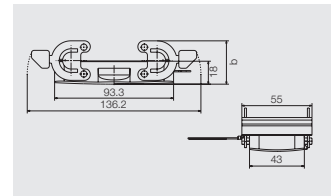

Base

Bulkhead housing



Version	Cover	b (mm)	Designation	Order No.
		29	HDC 16B ABU	1208600000

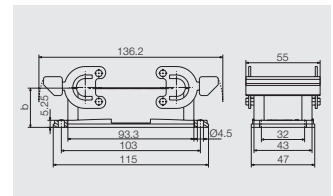

Base housing



a	Version	Cover	b (mm)	Designation	Order No.
M 25	with thread		64	HDC 16B SBU 2M25G	1788240000
M 25	with thread		84	HDC 40D SBU 2M25G	1787120000
M 32	with thread		84	HDC 40D SBU 2M32G	1787110000

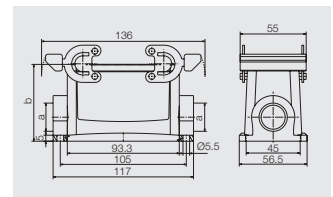

Coupling hood



a	Version	Cover	b (mm)	Designation	Order No.
M 25	with thread		79	HDC 40D KBU 1M25G	1787200000
M 32	with thread		79	HDC 40D KBU 1M32G	1787190000

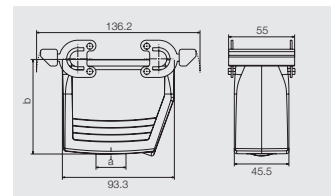

Cover



Version	Designation	Order No.
for bases	HDC 16B DODQ 4BO	1665260000

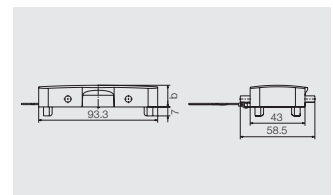

MixMate series - the high-capacity connectors

630 V, 100 A, Size 8

6+6 + ⊕

Inserts



Axial screw connection



Insert	Designation	Order No.
Male	HDC S6 6 SAS	1790030000
Female	HDC S6 6 BAS	1790020000

Note Please note: the signal contacts are designed for a rated voltage of 400V and a rated current of 16A.

Dimensions

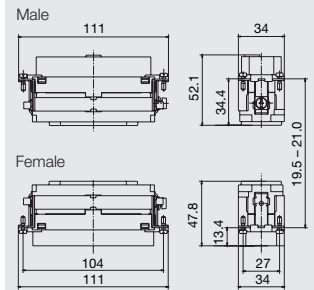

Arrangement of contacts

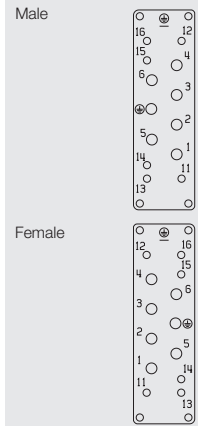

Mounting cut-out

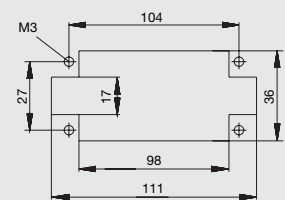

Selection of Housings RockStar® IP65
Size 8



Hood

Hood, Cable Entry sideways



a	Version	Cover	b (mm)	Designation	Order No.
M 25	with thread		61	HDC 24B TSBU 1M25G	1787760000
M 32	with thread		61	HDC 24B TSBU 1M32G	1787750000
M 25	with thread		76	HDC 64D TSBU 1M25G	1786780000
M 32	with thread		76	HDC 64D TSBU 1M32G	1786770000

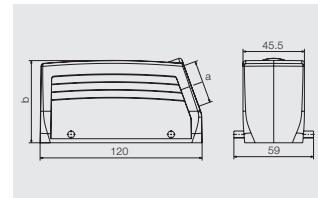

Hood, Cable Entry at top



a	Version	Cover	b (mm)	Designation	Order No.
M 25	with thread		61	HDC 24B TOBU 1M25G	1787820000
M 32	with thread		61	HDC 24B TOBU 1M32G	1787810000
M 32	with thread		76	HDC 64D TOBU 1M32G	1786830000

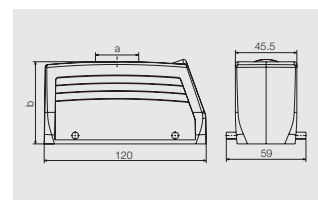

Cover

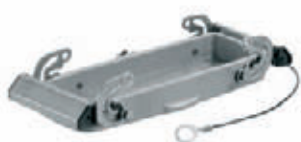

Version	Designation	Order No.
for hoods	HDC 24B DMDQ 2QB	1665640000

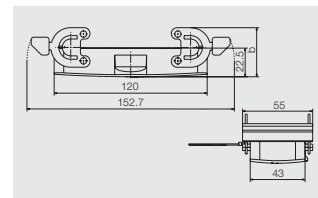

Base

Bulkhead housing



Version	Cover	b (mm)	Designation	Order No.
		29.3	HDC 24B ABU	1212400000

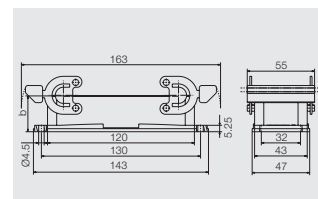

Base housing



a	Version	Cover	b (mm)	Designation	Order No.
M 25	with thread		64	HDC 24B SBU 2M25G	1787870000
M 25	with thread		84	HDC 64D SBU 2M25G	1786890000
M 32	with thread		84	HDC 64D SBU 2M32G	1786880000

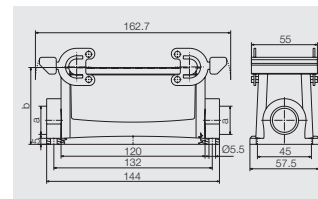

Coupling hood



a	Version	Cover	b (mm)	Designation	Order No.
M 25	with thread		65	HDC 24B KBU 1M25G	1787920000
M 32	with thread		79	HDC 64D KBU 1M32G	1786960000

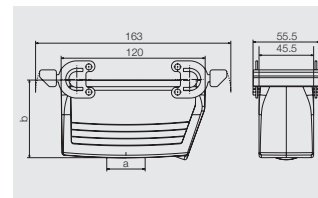

Cover



Version	Designation	Order No.
for bases	HDC 24B DODQ 4BO	1665630000

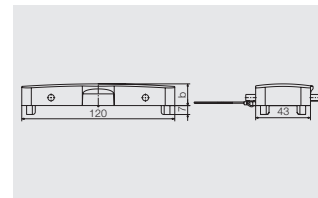

HQ series – the powerful little connectors

Small dimensions, but nevertheless capable. The electrical ratings speak for themselves and they are also suitable for the proven HE crimp contacts.

That makes for manageability and clarity.

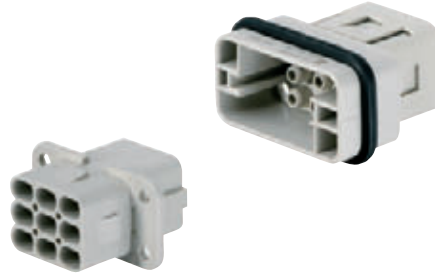





Technical data

Standards / approvals	
Standards	DIN EN 61984 DIN EN 60664-1
Approvals	UL/CSA
Inserts	
No. of poles	5, 8 (+PE)
Rated voltage	
– HQ 5	400 V (250 V Pole / PE)
– HQ 8	500 V
Rated voltage to UL/CSA	600 V
Rated current	16 A
Rated impulse withstand voltage	
– HQ 5	4 kV
– HQ 8	6 kV
Pollution severity	3
Insulation resistance	$\geq 10^{10} \Omega$
Material	Glass-fibre reinforced PC (in UL list and approved for railway applications)
Temperature range	-40 °C ... +125 °C
Flammability to UL 94	V-0
Mechanical service life	
– Plugging cycles Ag - Surface	≥ 500
– Plugging cycles Au - Surface	≥ 500
Contact resistance	
– Crimp connection	$\leq 4 \text{ m}\Omega$
Contacts / Material	
Sockets and plug-in contact	Copper alloy
Surface	Passivated silver, or 0.8 μm gold on 2 μm nickel
Crimp connection	
– Flexible conductor connection	0.5 - 4 mm ² (AWG 20 ... 12)
– Stripping length	7.5 mm
Clamping torque	
– Screw connection	
SD blades	
– Screw connection	
– Push In	
– Tension clamp connection	
PE connection	
– Clamping range	0.5 ... 4 mm ²
– solid / stranded	0.5 ... 4 mm ² / 0.5 ... 4 mm ²
– flexible / flexible with wire end ferrule, DIN 46228 pt. 1	0.5 ... 4 mm ² / 0.5 ... 4 mm ²
– AWG conductor	AWG 20 .. 12
– Stripping length	10 mm
– Clamping torque	1.2 ... 1.5 Nm
– Blade dimensions	SD 0.8 x 4 mm or PZ 1

Note: Switch off power supply before handling plug-in connectors.

Overview

		Rated voltage	Rated current	No. of poles	Tension clamp connection	Screw conn. with wire guard spring	Crimp connection	Push In	Axial screw connection	Page
		400 V	16 A	5 + ⊕			•			B.106
		500 V	16 A	8 + ⊕			•			B.108

HQ series - the powerful little connectors

400 V, 16 A, Size 1

5 + ⊕

Inserts



Crimp connection



Insert	Designation	Order No.
Male	HDC HQ 5 MC	1912440000
Female	HDC HQ 5 FC	1912460000

Dimensions

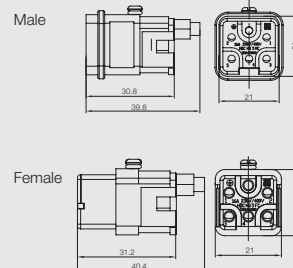

Accessories

Crimp contacts

Surface silver



Surface gold



Qty.	Male	Order No.	Female	Order No.
100	HDC-C-HE-SM0.5AG	1200500000	HDC-C-HE-BM0.5AG	1201100000
100	HDC-C-HE-SM0.75-1AG	1200600000	HDC-C-HE-BM0.75-1AG	1201200000
100	HDC-C-HE-SM1.5AG	1200700000	HDC-C-HE-BM1.5AG	1201300000
100	HDC-C-HE-SM2.5AG	1200800000	HDC-C-HE-BM2.5AG	1201400000
100	HDC-C-HE-SM4.0AG	1200900000	HDC-C-HE-BM4.0AG	1201500000
100	HDC-C-HE-SM0.5AU	1651420000	HDC-C-HE-BM0.5AU	1651470000
100	HDC-C-HE-SM0.75-1AU	1651430000	HDC-C-HE-BM0.75-1AU	1651480000
100	HDC-C-HE-SM1.5AU	1651440000	HDC-C-HE-BM1.5AU	1651490000
100	HDC-C-HE-SM2.5AU	1651450000	HDC-C-HE-BM2.5AU	1651500000
100	HDC-C-HE-SM4.0AU	1651460000	HDC-C-HE-BM4.0AU	1651510000

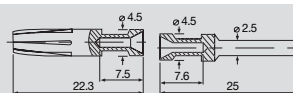

Single contacts

Conductor mm ²	AWG No.
0.50	20
0.75-1.00	18
1.50	16
2.50	14
4.00	12

Tools



Tool	Order No.
Crimping tool CTX CM 1.6/2.5	9018490000
Contact removal tool Removal Tool HE	1866750000

Selection of Housings RockStar® IP65
Size 1



Hood

material: Diecast aluminium

Hood, Cable Entry sideways



a	Version	Cover	b (mm)	Designation	Order No.
M 20	with thread		49,2	HDC 04A TWLU 1M20G	1788810000

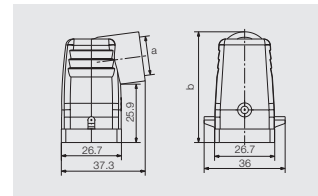

Hood, Cable Entry at top



a	Version	Cover	b (mm)	Designation	Order No.
M 20	with thread		50	HDC 04A TOLU 1M20G	1788820000

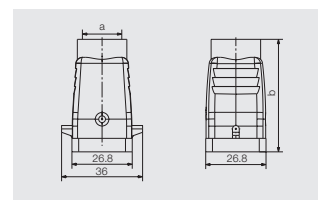

Base

Bulkhead housing



Version	Cover	b (mm)	Designation	Order No.
		23	HDC 04A ALU	1497600000

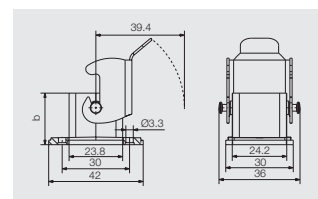

Base housing



a	Version	Cover	b (mm)	Designation	Order No.
M 20	with thread		25,8	HDC 04A SLU 1M20G	1788830000

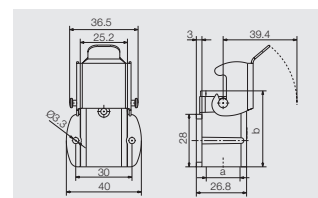

Coupling hood



a	Version	Cover	b (mm)	Designation	Order No.
M 20	with thread		53,5	HDC 04A KOLU 1M20G	1788840000

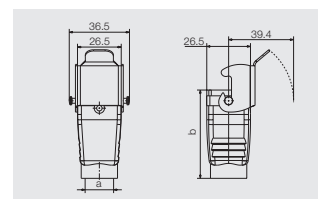

Screw Mounting Housing



a	Version	Cover	b (mm)	Designation	Order No.
M 20	with thread		54	HDC 04A ELU 1M20G	1900320000
PG 13,5	with thread		54	HDC 04A ELU 1PG13G	1900330000
PG 13,5	with thread		54	HDC 04A ELU 1PG13G EXI	1900350000

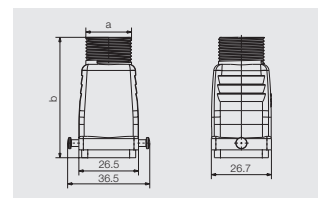

Cover



Version	Designation	Order No.
for female insert	HDC 04A DMDL 2BO	1665750000
for male insert	HDC 04A DODL 2BO	1665740000

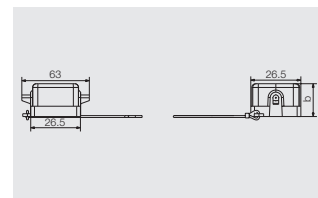

HQ series - the powerful little connectors

500 V, 16 A

8 + ⊕

Inserts



Crimp connection



Insert	Designation	Order No.
Male	HDC HQ 8 MC	1919970000
Female	HDC HQ 8 FC	1919980000

Dimensions

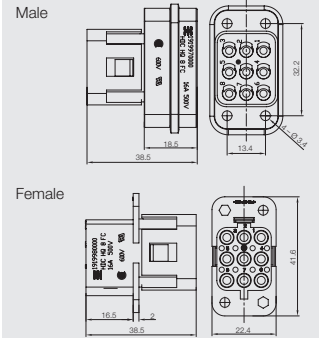

Accessories

Crimp contacts

Surface silver



Surface gold



Qty.	Male	Order No.	Female	Order No.
100	HDC-C-HE-SM0.5AG	1200500000	HDC-C-HE-BM0.5AG	1201100000
100	HDC-C-HE-SM0.75-1AG	1200600000	HDC-C-HE-BM0.75-1AG	1201200000
100	HDC-C-HE-SM1.5AG	1200700000	HDC-C-HE-BM1.5AG	1201300000
100	HDC-C-HE-SM2.5AG	1200800000	HDC-C-HE-BM2.5AG	1201400000
100	HDC-C-HE-SM4.0AG	1200900000	HDC-C-HE-BM4.0AG	1201500000
100	HDC-C-HE-SM0.5AU	1651420000	HDC-C-HE-BM0.5AU	1651470000
100	HDC-C-HE-SM0.75-1AU	1651430000	HDC-C-HE-BM0.75-1AU	1651480000
100	HDC-C-HE-SM1.5AU	1651440000	HDC-C-HE-BM1.5AU	1651490000
100	HDC-C-HE-SM2.5AU	1651450000	HDC-C-HE-BM2.5AU	1651500000
100	HDC-C-HE-SM4.0AU	1651460000	HDC-C-HE-BM4.0AU	1651510000

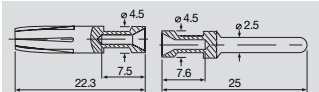

Single contacts

Conductor mm ²	AWG No.
0.50	20
0.75-1.00	18
1.50	16
2.50	14
4.00	12

Tools



Tool	Order No.
Crimping tool CTX CM 1.6/2.5	9018490000
Contact removal tool Removal Tool HE	1866750000

CabinetMate DSTV-HE series – connector at front, terminal at rear

CabinetMate DSTV-HE offers a simple solution for connecting conductors from inside the switch cabinet. From the outside of the switch cabinet, users can connect to their equipment using HE series inserts.



Technical data

Standards / approvals	
Standards	DIN EN 61984 DIN EN 60664-1
Approvals	
Contact inserts	
No. of poles	6, 10, 16, 24 (+PE)
Rated voltage	500 V
Rated current	16 A
Rated impulse withstand voltage	6 kV
Pollution severity	3
Insulation resistance	10 ¹⁰ Ω
Material	Glass fibre reinforced thermoplastic moulding (UL listed)
Temperature range	-40° ... +110°C
Flammability to UL 94	V-2
Mechanical service life	
Plugging cycles Ag	≤ 200
Rated voltage to UL / CSA	600 V AC/DC
Contacts	
Material	Copper alloy
Surface	3 μm Ag
Clamping range	
Screw connection	0.5 ... 4 mm ² / AWG 20 ... 12
Tension clamp connection	0.5 ... 2.5 mm ² / AWG 20 ... 14
Clamping torque	0.4 ... 0.7 Nm
Stripping length	
Screw connection	12.0 mm
Tension clamp connection	6.0 mm

Derating curves

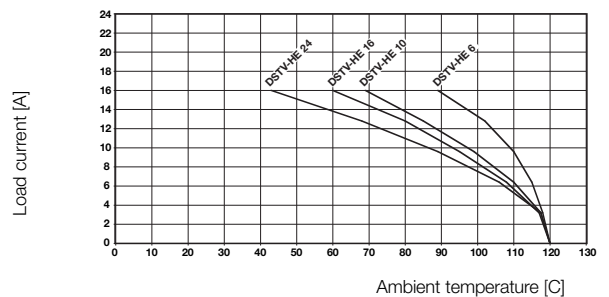

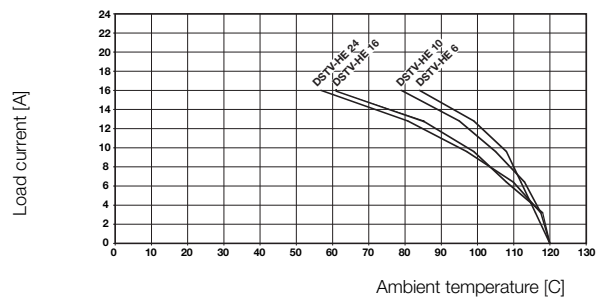

Tension spring connection 2,5 mm² conductor



Screw connection 2,5 mm² conductor

Overview

	Rated voltage	Rated current	No. of poles	Tension clamp connection	Screw conn. with wire guard spring	Crimp connection	Push In	Axial screw connection	Page
	500 V	16 A	6 + ⊕	•	•				B.112
	500 V	16 A	10 + ⊕	•	•				B.114
	500 V	16 A	16 + ⊕	•	•				B.116
	500 V	16 A	24 + ⊕	•	•				B.118

CabinetMate DSTV-HE series – connector at front, terminal at rear

500 V, 16 A, Size 3

6 + ⊕

Inserts



Tension clamp connection



Insert	Designation	Order No.
Male	DSTV HE SR6 ZF	1837510000
Female	DSTV HE BR6 ZF	1837430000
Male	DSTV HE SL6 ZF	1837470000
Female	DSTV HE BL6 ZF	1837390000

Screw connection



Insert	Designation	Order No.
Male	DSTV HE SR6 S	1848740000
Female	DSTV HE BR6 S	1848600000
Male	DSTV HE SL6 S	1848660000
Female	DSTV HE BL6 S	1848550000

SR – PE conductor right
 BR – PE conductor right
 SL – PE conductor left
 BL – PE conductor left

ZF – Tension clamp connection
 S – Screw connection

Dimensions

earthing contact on the left

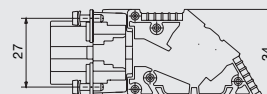
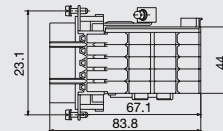

earthing contact on the right

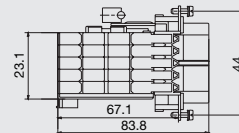

Selection of Housings RockStar® IP65



Base

Bulkhead housing



Version	Cover	b (mm)	Designation	Order No.
		29	HDC 06B ALU	1202100000
	with cover	47	HDC 06B ADLU	1202500000

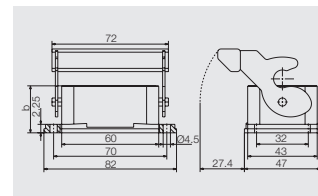

CabinetMate DSTV-HE series – connector at front, terminal at rear

500 V, 16 A, Size 4

10 + ⊕

Inserts



Tension clamp connection



Insert	Designation	Order No.
Male	DSTV HE SR10 ZF	1837520000
Female	DSTV HE BR10 ZF	1837440000
Male	DSTV HE SL10 ZF	1837480000
Female	DSTV HE BL10 ZF	1837400000

Screw connection



Insert	Designation	Order No.
Male	DSTV HE SR10 S	1848750000
Female	DSTV HE BR10 S	1848610000
Male	DSTV HE SL10 S	1848680000
Female	DSTV HE BL10 S	1848570000

SR – PE conductor right
 BR – PE conductor right
 SL – PE conductor left
 BL – PE conductor left

ZF – Tension clamp connection
 S – Screw connection

Dimensions

earthing contact on the left

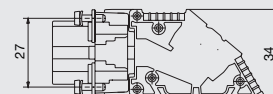
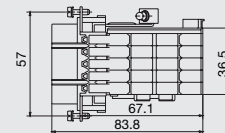

earthing contact on the right

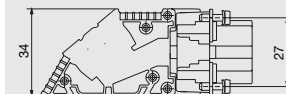
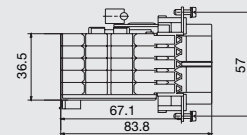

Selection of Housings RockStar® IP65



Base

Bulkhead housing



Version	Cover	b (mm)	Designation	Order No.
		29,3	HDC 10B ABU	1205000000

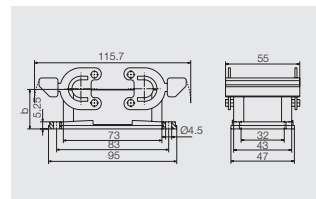

CabinetMate DSTV-HE series – connector at front, terminal at rear

500 V, 16 A, Size 6

16 + ⊕

Inserts



Tension clamp connection



Insert	Designation	Order No.
Male	DSTV HE SR16 ZF	1837530000
Female	DSTV HE BR16 ZF	1837450000
Male	DSTV HE SL16 ZF	1837490000
Female	DSTV HE BL16 ZF	1837410000

Screw connection



Insert	Designation	Order No.
Male	DSTV HE SR16 S	1848760000
Female	DSTV HE BR16 S	1848620000
Male	DSTV HE SL16 S	1848700000
Female	DSTV HE BL16 S	1848580000

SR – PE conductor right
 BR – PE conductor right
 SL – PE conductor left
 BL – PE conductor left

ZF – Tension clamp connection
 S – Screw connection

Dimensions

earthing contact on the left

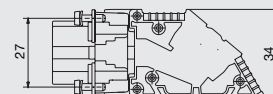
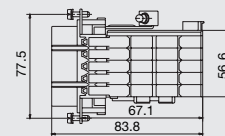

earthing contact on the right

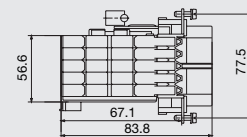

Selection of Housings RockStar® IP65



Base

Bulkhead housing



Version	Cover	b (mm)	Designation	Order No.
		29	HDC 16B ABU	1208600000

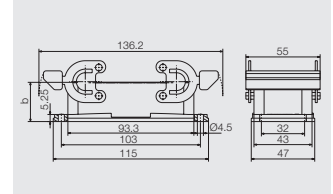

500 V, 16 A, Size 8

24 + ⊕

Inserts



Tension clamp connection



Insert	Designation	Order No.
Male	DSTV HE SR24 ZF	1837540000
Female	DSTV HE BR24 ZF	1837460000
Male	DSTV HE SL24 ZF	1837500000
Female	DSTV HE BL24 ZF	1837420000

Screw connection



Insert	Designation	Order No.
Male	DSTV HE SR24 S	1848770000
Female	DSTV HE BR24 S	1848630000
Male	DSTV HE SL24 S	1848730000
Female	DSTV HE BL24 S	1848590000

SR – PE conductor right
 BR – PE conductor right
 SL – PE conductor left
 BL – PE conductor left

ZF – Tension clamp connection
 S – Screw connection

Dimensions

earthing contact on the left

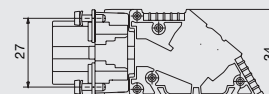
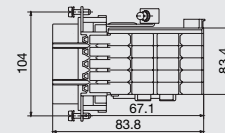

earthing contact on the right

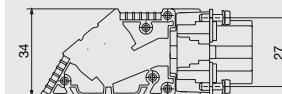
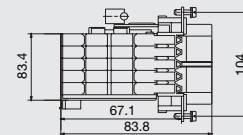

Selection of Housings RockStar® IP65



Base

Bulkhead housing



Version	Cover	b (mm)	Designation	Order No.
		29,3	HDC 24B ABU	1212400000

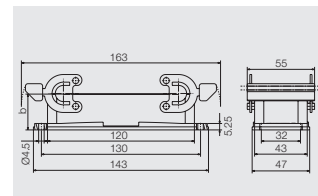

CabinetMate DSTV-HD series – connector at front, terminal at rear

CabinetMate DSTV-HD offers a simple solution for connecting conductors from inside the switch cabinet. Usable with inserts from the HD series.



Technical data

Standards / approvals	
Standards	DIN EN 61984 DIN EN 60664-1
Approvals	UL CE
Contact inserts	
No. of poles	16, 24, 40, 64 (+ PE)
Rated voltage (VDE 110/2.79)	250 V ~ / 300 V -
Rated current	10 A
Test voltage	2.5 kV
Insulation group	C
Specific contact resistance	$10^{16} \Omega/\text{cm}$
Insulation resistance	$10^{13} \Omega$
Material	Glass fibre reinforced thermoplastic moulding (UL listed)
Temperature range	-40° ... +125°C
Flammability to UL 94	V-0
Mechanical service life	
plugging cycles Ag	≤ 100
Nominal voltage to UL / CSA	600 V AC/DC
Contacts	
Material	Copper alloy
Surface	
hard silver plated	3 μm Ag
Contact resistance	< 2 m Ω
Clamping range	0.5 ... 1.5 mm ² / AWG 20 ... 16
Clamping torque	0.4 Nm
Stripping length	10.0 mm

Derating curves

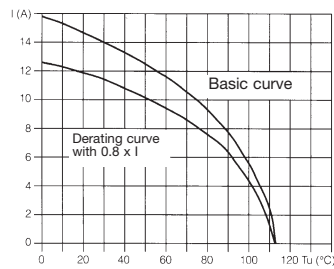



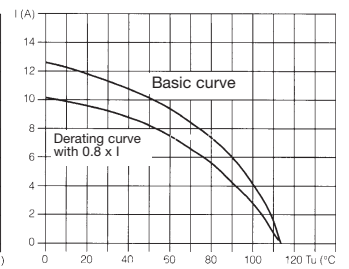

Test specimen DSTV-HD 16/HDC-HD-16
Conductor H07V-K 1.5 mm²



Test specimen DSTV-HD 64/HDC-HD-64
Conductor H07V-K 1.5 mm²

Overview

	Rated voltage	Rated current	No. of poles	Tension clamp connection	Screw conn. with wire guard spring	Crimp connection	Push In	Axial screw connection	Page
	250 V	10 A	16 + ⊕		•				B.122
	250 V	10 A	24 + ⊕		•				B.124
	250 V	10 A	40 + ⊕		•				B.126
	250 V	10 A	64 + ⊕		•				B.128

CabinetMate DSTV-HD series – connector at front, terminal at rear

250 V, 10 A, Size 3

16 + ⊕

Inserts



Screw connection



Insert	Designation	Order No.
Male	DSTV-HD-SR 16 AU	1566370000
Female	DSTV-HD-BR 16 AU	1566330000
Female	DSTV-HD-BR 16 SN	1566650000
Male	DSTV-HD-SL 16 AU	1566450000
Female	DSTV-HD-BL 16 SN	1566730000

SR – PE conductor right
 BR – PE conductor right
 SL – PE conductor left
 BL – PE conductor left

Dimensions

earthing contact on the left

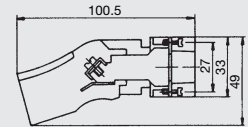
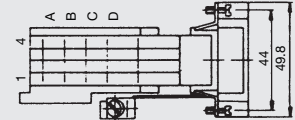

earthing contact on the right

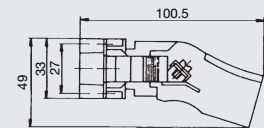
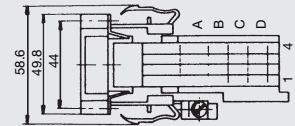

Accessories

Snap-on tags



Qty.	Designation	Order No.	Designation	Order No.
1000	SF 10 BEZ. 0-9	0332400000	SG 10 BEZ. 4	0332500004
1000	SF 10 BEZ. 1-10	0331500001	SG 10 BEZ. 5	0332500005
1000	SF 10 BEZ. 11-20	0331500011	SG 10 BEZ. 6	0332500006
1000	SG 10 BEZ. 0	0332501000	SG 10 BEZ. 7	0332500007
1000	SG 10 BEZ. 1	0332500001	SG 10 BEZ. 8	0332500008
1000	SG 10 BEZ. 2	0332500002	SG 10 BEZ. 9	0332500009
1000	SG 10 BEZ. 3	0332500003	SO 10	0332300000

Selection of Housings RockStar® IP65



Base

Bulkhead housing



Version	Cover	b (mm)	Designation	Order No.
		29	HDC 06B ALU	1202100000
	with cover	47	HDC 06B ADLU	1202500000

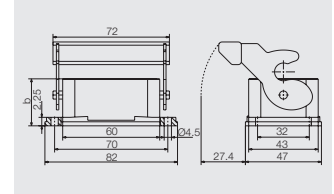

CabinetMate DSTV-HD series – connector at front, terminal at rear

250 V, 10 A, Size 4

24 + ⊕

Inserts



Screw connection



Insert	Designation	Order No.
Male	DSTV-HD-SR 24 SN	1566700000
Female	DSTV-HD-BR 24 SN	1566660000
Female	DSTV-HD-BL 24 AU	1566420000
Female	DSTV-HD-BL 24 SN	1566740000

SR – PE conductor right
 BR – PE conductor right
 SL – PE conductor left
 BL – PE conductor left

Dimensions

earthing contact on the left

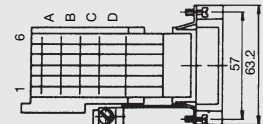

earthing contact on the right

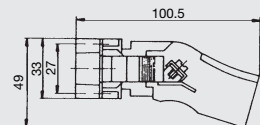
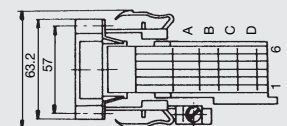

Accessories

Snap-on tags



Qty.	Designation	Order No.	Designation	Order No.
1000	SF 10 BEZ. 0-9	0332400000	SG 10 BEZ. 4	0332500004
1000	SF 10 BEZ. 1-10	0331500001	SG 10 BEZ. 5	0332500005
1000	SF 10 BEZ. 11-20	0331500011	SG 10 BEZ. 6	0332500006
1000	SG 10 BEZ. 0	0332501000	SG 10 BEZ. 7	0332500007
1000	SG 10 BEZ. 1	0332500001	SG 10 BEZ. 8	0332500008
1000	SG 10 BEZ. 2	0332500002	SG 10 BEZ. 9	0332500009
1000	SG 10 BEZ. 3	0332500003	SO 10	0332300000

Selection of Housings RockStar® IP65



Base

Bulkhead housing



Version	Cover	b (mm)	Designation	Order No.
		29,3	HDC 10B ABU	1205000000

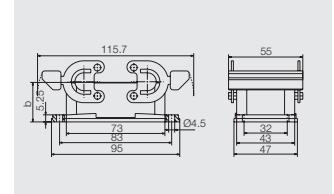

CabinetMate DSTV-HD series – connector at front, terminal at rear

250 V, 10 A, Size 6

40 + ⊕

Inserts



Screw connection



Insert	Designation	Order No.
Male	DSTV-HD-SR 40 AU	1566390000
Male	DSTV-HD-SR 40 SN	1566710000
Female	DSTV-HD-BR 40 AU	1566350000
Female	DSTV-HD-BR 40 SN	1566670000
Male	DSTV-HD-SL 40 AU	1566470000
Male	DSTV-HD-SL 40 SN	1566790000
Female	DSTV-HD-BL 40 AU	1566430000
Female	DSTV-HD-BL 40 SN	1566750000

SR – PE conductor right
 BR – PE conductor right
 SL – PE conductor left
 BL – PE conductor left

Dimensions

earthing contact on the left

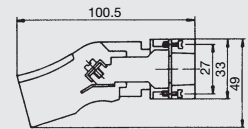
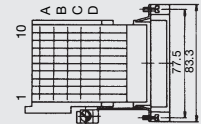

earthing contact on the right

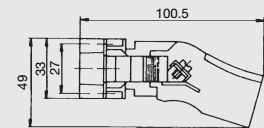
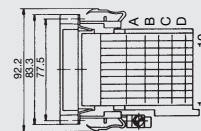

Accessories

Snap-on tags



Qty.	Designation	Order No.	Designation	Order No.
1000	SF 10 BEZ. 0-9	0332400000	SG 10 BEZ. 4	0332500004
1000	SF 10 BEZ. 1-10	0331500001	SG 10 BEZ. 5	0332500005
1000	SF 10 BEZ. 11-20	0331500011	SG 10 BEZ. 6	0332500006
1000	SG 10 BEZ. 0	0332501000	SG 10 BEZ. 7	0332500007
1000	SG 10 BEZ. 1	0332500001	SG 10 BEZ. 8	0332500008
1000	SG 10 BEZ. 2	0332500002	SG 10 BEZ. 9	0332500009
1000	SG 10 BEZ. 3	0332500003	SO 10	0332300000

Selection of Housings RockStar® IP65



Base

Bulkhead housing



Version	Cover	b (mm)	Designation	Order No.
		29	HDC 16B ABU	1208600000

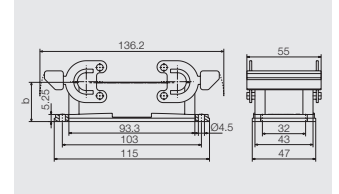

CabinetMate DSTV-HD series – connector at front, terminal at rear

250 V, 10 A, Size 8

64 + ⊕



Inserts

Screw connection



Insert	Designation	Order No.
Male	DSTV-HD-SR 64 AU	1566400000
Male	DSTV-HD-SR 64 SN	1566720000
Female	DSTV-HD-BR 64 AU	1566360000
Female	DSTV-HD-BR 64 SN	1566680000
Male	DSTV-HD-SL 64 AU	1566480000
Male	DSTV-HD-SL 64 SN	1566800000
Female	DSTV-HD-BL 64 AU	1566440000
Female	DSTV-HD-BL 64 SN	1566760000

SR – PE conductor right
 BR – PE conductor right
 SL – PE conductor left
 BL – PE conductor left

Dimensions

earthing contact on the left

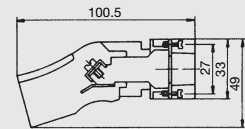
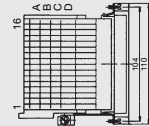

earthing contact on the right

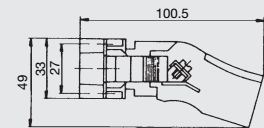
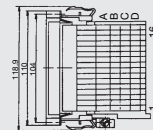

Accessories

Snap-on tags



Qty.	Designation	Order No.	Designation	Order No.
1000	SF 10 BEZ. 0-9	0332400000	SG 10 BEZ. 4	0332500004
1000	SF 10 BEZ. 1-10	0331500001	SG 10 BEZ. 5	0332500005
1000	SF 10 BEZ. 11-20	0331500011	SG 10 BEZ. 6	0332500006
1000	SG 10 BEZ. 0	0332501000	SG 10 BEZ. 7	0332500007
1000	SG 10 BEZ. 1	0332500001	SG 10 BEZ. 8	0332500008
1000	SG 10 BEZ. 2	0332500002	SG 10 BEZ. 9	0332500009
1000	SG 10 BEZ. 3	0332500003	SO 10	0332300000

Selection of Housings RockStar® IP65



Base

Bulkhead housing



Version	Cover	b (mm)	Designation	Order No.
		29,3	HDC 24B ABU	1212400000

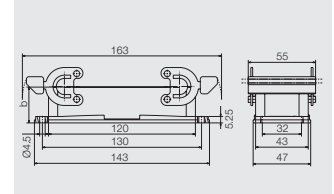

RockStar® ConCept modular system

RockStar® ConCept modular system	Overview	C.2
	ConCept modules	C.3
	ConCept bus modules	C.12
	ConCept construction frame	C.18
	ModuFlex C	C.30

RockStar® ConCept modular system

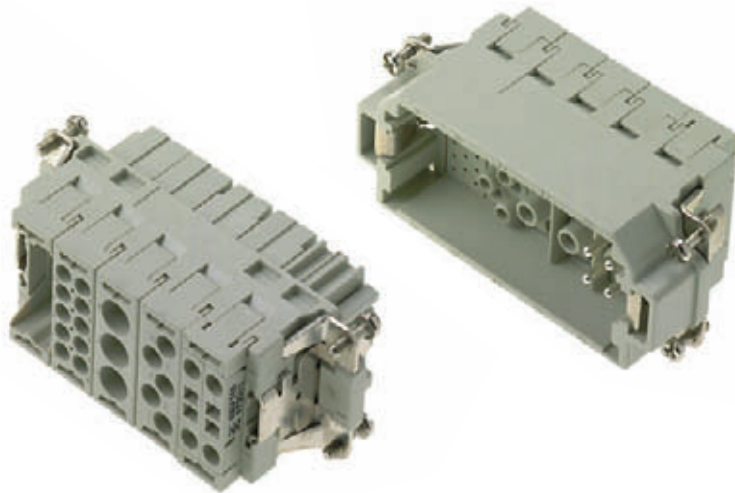

ConCept is a modular system consisting of modules and frames. Together they form a complete insert that integrates without difficulty into an HDC housing.

The system allows you to choose combinations of different modules yourself and insert them in a frame.

The following modules are available:

- ConCept modules for conventional conductors
- ConCept bus modules for fieldbus connections
- ConCept fibre optic modules
- ConCept pneumatic modules

You have two alternatives:

1. Combine modules with a ConCept module frame which you then integrate as an insert into an HDC housing.
2. Insert the modules individually into ModuFlex-C coupling frames and lock these frames together to form a block. In IP20 environments, this block is optionally used:
 - on mounting rails
 - in cable trays
 - on flat surfaces

The advantages:

- You save space – you need only one plug-in connector with ConCept inserts instead of several plug-in connectors with conventional fixed pole inserts.
- You save costs – because you only need one plug-in connector instead of many.

CM-3 ConCept module / turned contacts



Technical Data

Contact inserts

Rated current	40 A
Rated voltage	630 V
Rated impulse withstand voltage	8.0 kV
Pollution severity	3
Insulation resistance	10 ¹² Ω
Overvoltage category	III
Volume resistance	≤ 4 mΩ
UL 94 flammability class	V-0

Contacts

Contact dia.	3.6 mm
Connection cross-section	1.5-10 mm ²
AWG conductor	AWG 16-AWG 8
Base material	copper alloy
Silver surface	3 μm
Gold surface	

Note

Ring cable lugs must be used at the connection to the PE conductor for conductor cross-sections of 6 mm² to 10 mm². The rated voltage of 630V is also valid for 3-phase 4- or 3-conductor AC systems with rated voltages up to 630 V - acc. to DIN EN 60664-1.

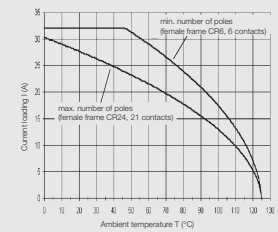

ConCept module CM-3
Conductor H07V-K 4.0 mm²

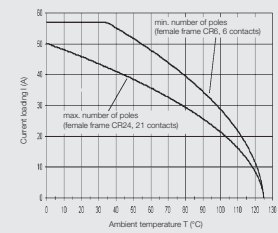

ConCept module CM-3
Conductor H07V-K 10.0 mm²

Modules

Crimp connection



Insert	Designation	Order No.
Male	HDC CM 3 MC	1758360000
Female	HDC CM 3 FC	1758370000
Male	HDC CM 3 MC MR	1879030000
Female	HDC CM 3 FC MR	1879040000

Note MR = module release lever

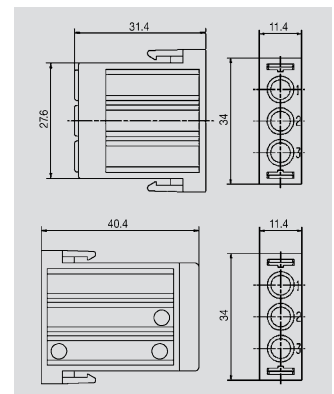

Accessories

Crimp contacts

Surface silver



Qty.	Male	Order No.	Female	Order No.
100	HDC-C-M3-SM1.5AG	1698120000	HDC-C-M3-BM1.5AG	1698130000
100	HDC-C-M3-SM2.5AG	1698140000	HDC-C-M3-BM2.5AG	1698150000
100	HDC-C-M3-SM4.0AG	1682260000	HDC-C-M3-BM4.0AG	1682270000
100	HDC-C-M3-SM6.0AG	1682280000	HDC-C-M3-BM6.0AG	1682290000
100	HDC-C-M3-SM10.0AG	1682300000	HDC-C-M3-BM10.0AG	1682310000

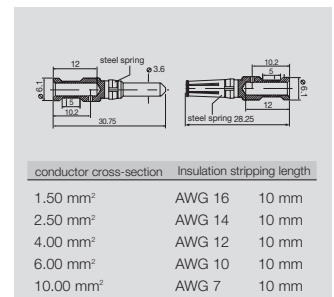

Tools



Crimping tool	Order No.
CTX CM 3.6	9018480000
Contact removal tool	Order No.
Removal Tool CM 3	1866710000

ConCept modules

CM-HE ConCept module / turned contacts

Technical Data

Contact inserts

Rated current	25 A
Rated voltage	630 V
Rated impulse withstand voltage	8.0 kV
Pollution severity	3
Insulation resistance	10 ¹² Ω
Overvoltage category	III
Volume resistance	≤ 4 mΩ
UL 94 flammability class	V-0

Contacts

Contact dia.	2.5 mm
Connection cross-section	0.5-4 mm ²
AWG conductor	AWG 20-AWG 12
Base material	copper alloy
Silver surface	3 μm
Gold surface	0.8 μm

Note

ferrules must be used with PE conductor cross-sections ≤ 0.75 mm².

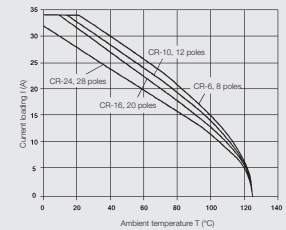

ConCept module CM-HE
Conductor H07V-K 4.0 mm²

Modules

Crimp connection



Insert	Designation	Order No.
Male	HDC CM HE 4 MC	1861920000
Female	HDC CM HE 4 FC	1861900000
Male	HDC CM HE 4 MC MR	1758340000
Female	HDC CM HE 4 FC MR	1758350000

Note MR = module release lever

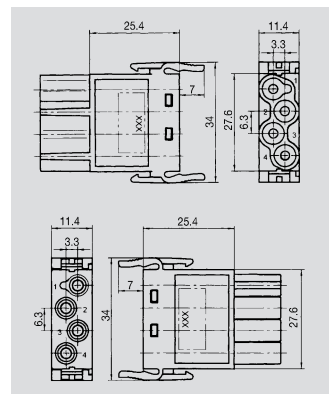

Accessories

Crimp contacts

Surface silver



Surface gold



Qty.	Male	Order No.	Female	Order No.
100	HDC-C-HE-SM0.5AG	1200500000	HDC-C-HE-BM0.5AG	1201100000
100	HDC-C-HE-SM0.75-1AG	1200600000	HDC-C-HE-BM0.75-1AG	1201200000
100	HDC-C-HE-SM1.5AG	1200700000	HDC-C-HE-BM1.5AG	1201300000
100	HDC-C-HE-SM2.5AG	1200800000	HDC-C-HE-BM2.5AG	1201400000
100	HDC-C-HE-SM4.0AG	1200900000	HDC-C-HE-BM4.0AG	1201500000
100	HDC-C-HE-SM0.5AU	1651420000	HDC-C-HE-BM0.5AU	1651470000
100	HDC-C-HE-SM0.75-1AU	1651430000	HDC-C-HE-BM0.75-1AU	1651480000
100	HDC-C-HE-SM1.5AU	1651440000	HDC-C-HE-BM1.5AU	1651490000
100	HDC-C-HE-SM2.5AU	1651450000	HDC-C-HE-BM2.5AU	1651500000
100	HDC-C-HE-SM4.0AU	1651460000	HDC-C-HE-BM4.0AU	1651510000

conductor cross-section	Insulation stripping length
1.50 mm ²	AWG 16 10 mm
2.50 mm ²	AWG 14 10 mm
4.00 mm ²	AWG 12 10 mm
6.00 mm ²	AWG 10 10 mm
10.00 mm ²	AWG 7 10 mm

Tools



Crimping tool	Order No.
CTX CM 1.6/2.5	9018490000
Contact removal tool	Order No.
Removal Tool HE	1866750000

CM-4 ConCept module with tension spring connection



Technical Data

Contact inserts

Rated current	14 A
Rated voltage	400 V
Rated impulse withstand voltage	6.0 kV
Pollution severity	3
Insulation resistance	10 ¹² Ω
Overvoltage category	III
Volume resistance	5 mΩ
UL 94 flammability class	V-0

Contacts

Contact dia.	2.5 mm
Connection cross-section	0.5-2.5 mm ²
AWG conductor	AWG 20-AWG 14
Base material	copper alloy
Silver surface	3 μm
Gold surface	

Note

ferrules must be used with PE conductor cross-sections ≤ 0.75 mm².

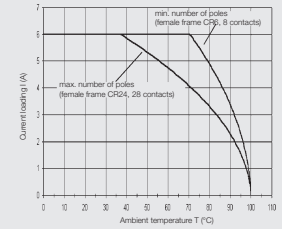

ConCept module CM-4BZF/4SZF
Conductor H05V-K 0.5 mm²

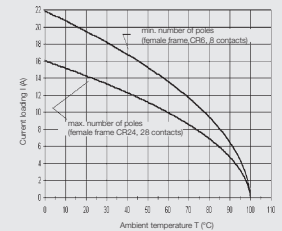

ConCept module CM-4BZF/4SZF
Conductor H07V-K 2.5 mm²

Modules

Tension clamp connection



Insert	Designation	Order No.
Male	HDC CM 4 MT AG	1730120000
Female	HDC CM 4 FT AG	1730130000

Note

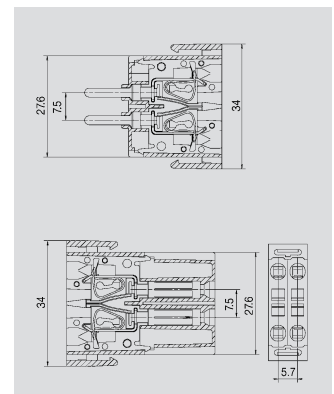

ConCept modules

CM-5 ConCept module / turned contacts

Technical Data

Contact inserts

Rated current	20 A
Rated voltage	250 V
Rated impulse withstand voltage	6.0 kV
Pollution severity	3
Insulation resistance	10 ¹² Ω
Overvoltage category	III
Volume resistance	≤ 4 mΩ
UL 94 flammability class	V-0

Contacts

Contact dia.	2.5 mm
Connection cross-section	0.75-4 mm ²
AWG conductor	AWG 20-AWG 12
Base material	copper alloy
Silver surface	3 μm
Gold surface	

Note

ferrules must be used with PE conductor cross-sections ≤ 0.75 mm².

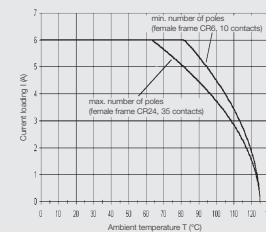

ConCept module CM-5
Conductor H05V-K 0.5 mm²

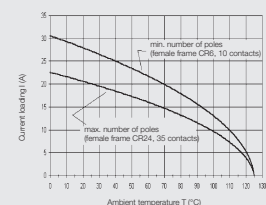

ConCept module CM-5
Conductor H07V-K 4.0 mm²

Modules

Crimp connection



Insert	Designation	Order No.
Male	HDC CM 5 MC	1758380000
Female	HDC CM 5 FC	1758390000
Male	HDC CM 5 MC MR	1879020000
Female	HDC CM 5 FC MR	1879010000

Note MR = module release lever

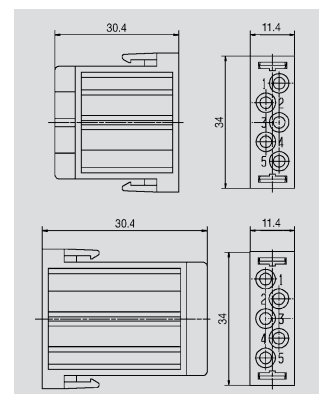

Accessories

Crimp contacts

Surface silver



Qty.	Male	Order No.	Female	Order No.
100	HDC-C-M5-SM0.75-1.0AG	1682340000	HDC-C-M5-BM0.75-1.0AG	1682350000
100	HDC-C-M5-SM1.5AG	1682360000	HDC-C-M5-BM1.5AG	1682370000
100	HDC-C-M5-SM2.5AG	1682380000	HDC-C-M5-BM2.5AG	1682390000
100	HDC-C-M5-SM4.0AG	1682400000	HDC-C-M5-BM4.0AG	1682410000

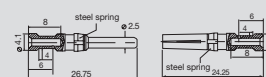

conductor cross-section	Insulation stripping length
0.75 - 1.00 mm ²	AWG 18 8 mm
1.50 mm ²	AWG 16 8 mm
2.50 mm ²	AWG 14 8 mm
4.00 mm ²	AWG 12 8 mm

Tools



Crimping tool	Order No.
CTX CM 1.6/2.5	9018490000
Contact removal tool	Order No.
Removal Tool CM 5	1866720000

CM-10 ConCept module / turned contacts



Technical Data

Contact inserts

Rated current	10 A
Rated voltage	250 V
Rated impulse withstand voltage	4.0 kV
Pollution severity	3
Insulation resistance	10 ¹¹ Ω
Overvoltage category	III
Volume resistance	≤ 4 mΩ
UL 94 flammability class	V-0

Contacts

Contact dia.	1.6 mm
Connection cross-section	0.14-2.5 mm ²
AWG conductor	AWG 26-AWG 14
Base material	copper alloy
Silver surface	3 μm
Gold surface	0.8 μm

Note

ferrules must be used with PE conductor cross-sections ≤ 0.75 mm².

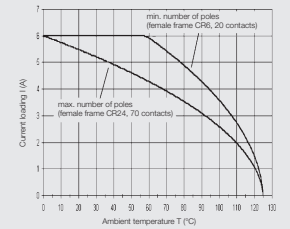

ConCept module CM-10
Conductor H05V-K 0.5 mm²

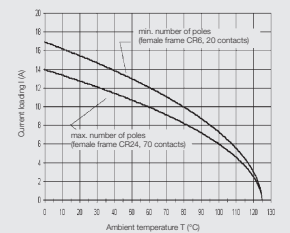

ConCept module CM-10
Conductor H07V-K 2.5 mm²

Modules

Crimp connection



Insert	Designation	Order No.
Male	HDC CM 10 MC	1758400000
Female	HDC CM 10 FC	1758410000
Male	HDC CM 10 MC MR	1862050000
Female	HDC CM 10 FC MR	1862030000

Note MR = module release lever

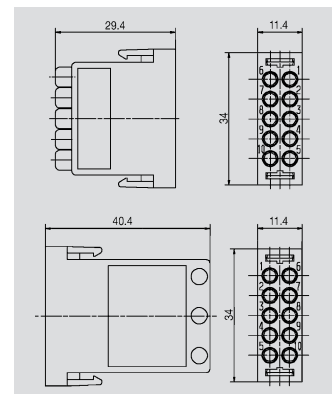

Accessories

Crimp contacts

Surface silver



Surface gold



Qty.	Male	Order No.	Female	Order No.
100	HDC-C-HD-SM0.14-0.37AG	1651520000	HDC-C-HD-BM0.14-0.37AG	1651570000
100	HDC-C-HD-SM0.5AG	1651530000	HDC-C-HD-BM0.5AG	1651580000
100	HDC-C-HD-SM0.75-1AG	1601750000	HDC-C-HD-BM0.75-1AG	1601760000
100	HDC-C-HD-SM1.5AG	1651550000	HDC-C-HD-BM1.5AG	1651600000
100	HDC-C-HD-SM2.5AG	1651560000	HDC-C-HD-BM2.5AG	1651610000
100	HDC-C-HD-SM0.14-0.37AU	1651620000	HDC-C-HD-BM0.14-0.37AU	1651670000
100	HDC-C-HD-SM0.5AU	1651630000	HDC-C-HD-BM0.5AU	1651680000
100	HDC-C-HD-SM0.75-1AU	1651640000	HDC-C-HD-BM0.75-1AU	1651690000
100	HDC-C-HD-SM1.5AU	1651650000	HDC-C-HD-BM1.5AU	1651700000
100	HDC-C-HD-SM2.5AU	1651660000	HDC-C-HD-BM2.5AU	1651710000

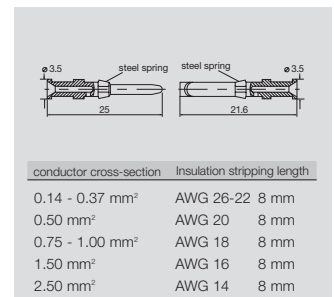

Tools



Crimping tool	Order No.
CTX CM 1.6/2.5	9018490000
Contact removal tool	Order No.
Removal Tool HD	1866730000

ConCept modules

CM-20 ConCept module / turned contacts



Technical Data

Contact inserts

Rated current	4 A
Rated voltage	100 V
Rated impulse withstand voltage	1.5 kV
Pollution severity	3
Insulation resistance	10 ¹² Ω
Overvoltage category	III
Volume resistance	≤ 4 mΩ
UL 94 flammability class	V-0

Contacts

Contact dia.	1 mm
Connection cross-section	0.08-0.52 mm ²
AWG conductor	AWG 28-AWG 20
Base material	copper alloy
Silver surface	
Gold surface	0.8 μm

Note

ferrules must be used with PE conductor cross-sections ≤ 0.75 mm².

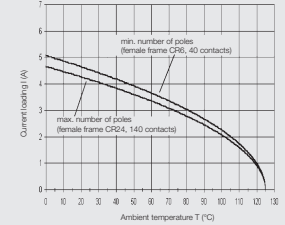

ConCept-Modul CM-20
AWG-Conductor 20/19

Modules

Crimp connection



Insert	Designation	Order No.
Male	HDC CM 20 MC	1758420000
Female	HDC CM 20 FC	1758430000

Note

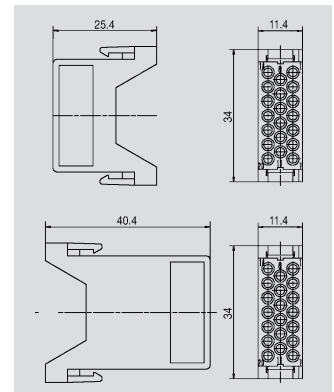

Accessories

Crimp contacts

Surface gold



Qty.	Male	Order No.	Female	Order No.
300	HDC-C-M20-SCG0.08-0.2AU	1682420000	HDC-C-M20-BCG0.08-0.2AU	1682430000
300	HDC-C-M20-SCG0.2-0.52AU	1682440000	HDC-C-M20-BCG0.2-0.52AU	1682450000

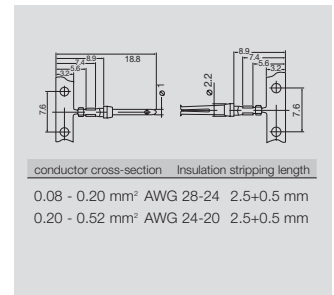

Tools



Crimping tool	Order No.
HDC-CM-20/CZC9428P	1700900000
Contact removal tool	Order No.
Removal Tool CM 20	1866740000

CM-3 HV



Technical Data

Contact inserts

Rated current	57 A
Rated voltage	1000 V
Rated impulse withstand voltage	8.0 kV
Pollution severity	3
Insulation resistance	10 ¹² Ω
Overvoltage category	III
Volume resistance	≤ 4 mΩ
UL 94 flammability class	V-0

Contacts

Contact dia.	3.6 mm
Connection cross-section	1.5-10 mm ²
AWG conductor	AWG 12-AWG 7
Base material	copper alloy
Silver surface	3 μm
Gold surface	

Note

Ring cable lugs must be used at the connection to the PE conductor for conductor cross-sections of 6 mm² to 10 mm².

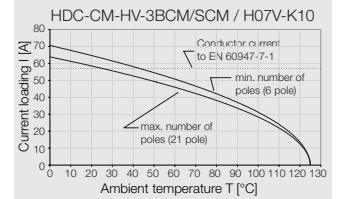
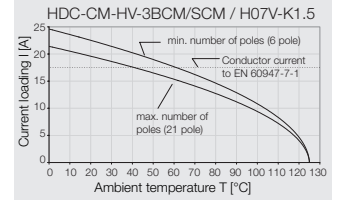

Modules

Crimp connection



Insert	Designation	Order No.
Male	HDC CM HV 3 MC	1862080000
Female	HDC CM HV 3 FC	1862060000
Male	HDC CM HV 3 MC MR	1862000000
Female	HDC CM HV 3 FC MR	1862070000

Note MR = module release lever

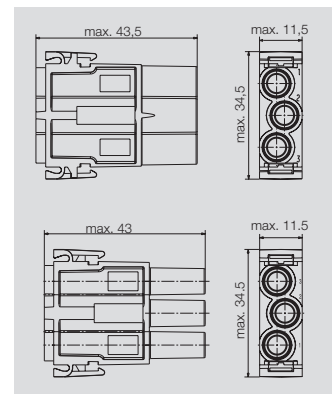

Accessories

Crimp contacts

Surface silver



Qty.	Male	Order No.	Female	Order No.
100	HDC-C-M3-SM1.5AG	1698120000	HDC-C-M3-BM1.5AG	1698130000
100	HDC-C-M3-SM2.5AG	1698140000	HDC-C-M3-BM2.5AG	1698150000
100	HDC-C-M3-SM4.0AG	1682260000	HDC-C-M3-BM4.0AG	1682270000
100	HDC-C-M3-SM6.0AG	1682280000	HDC-C-M3-BM6.0AG	1682290000
100	HDC-C-M3-SM10.0AG	1682300000	HDC-C-M3-BM10.0AG	1682310000

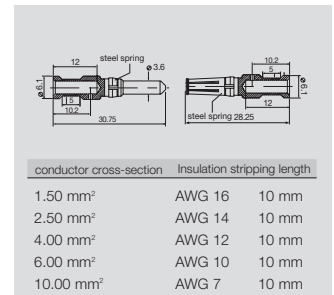

Tools



Tool	Order No.
Crimping tool CTX CM 3.6	9018480000
Contact removal tool Removal Tool CM 3	1866710000

ConCept modules

CM High Current Module

Technical Data

Contact inserts

Rated current	82 A
Rated voltage	1000 V
Rated impulse withstand voltage	6.0 kV
Pollution severity	3
Insulation resistance	10 ¹² Ω
Overvoltage category	III
Volume resistance	≤ 4 mΩ
UL 94 flammability class	V-0

Contacts

Contact dia.	
Connection cross-section	4-16 mm ²
AWG conductor	AWG 12-AWG 6
Base material	copper alloy
Silver surface	3 μm
Gold surface	

Note

These modules are designed as double modules and may be put into ConCept frames.

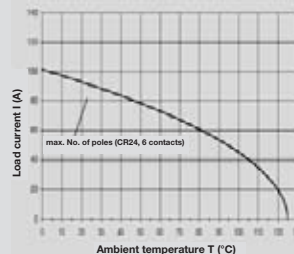

ConCept-Modul CM-2
Conductor 16 mm²

Modules

Screw connection



Insert	Designation	Order No.
Pin	HDC CM 1 MS + PE	1828390000
Socket	HDC CM 1 FS + PE	1828410000

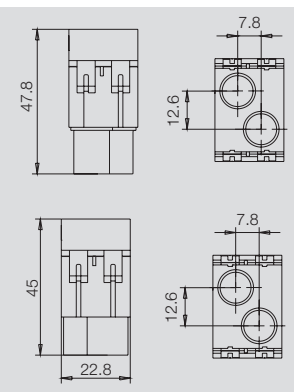

Modules

Screw connection



Insert	Designation	Order No.
Pin	HDC CM 2 MS	1828380000
Socket	HDC CM 2 FS	1828400000

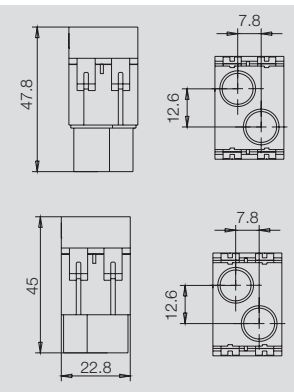

CM Pneumatic

Technical data

Contact inserts

Material of modules	PA 6.6 GF
Material of pneumatic valves	Ms 58 brass
Connection diameter of hose (inside)	2.5 mm or 4 mm
Outside diameter of hose, maximum	8 mm
Temperature range	-20°C to 100°C
Operating pressure of the modules	10 bar
Travel	4 mm

Note

Modules



Insert	Designation	Order No.
Male	HDC-CM-1SPN2.5	1894730000
Female	HDC-CM-1BPN2.5	1894780000
Male	HDC-CM-1SPN4.0	1894740000
Female	HDC-CM-1BPN4.0	1894720000

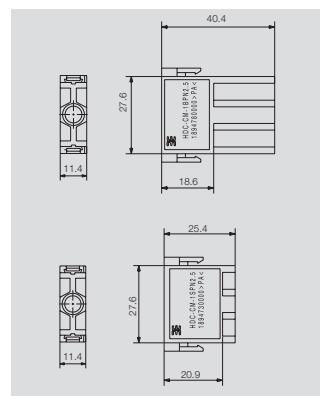

Modules



Insert	Designation	Order No.
Male	HDC-CM-2SPN2.5	1894770000
Female	HDC-CM-2BPN2.5	1894750000
Male	HDC-CM-2SPN4.0	1894710000
Female	HDC-CM-2BPN4.0	1894760000

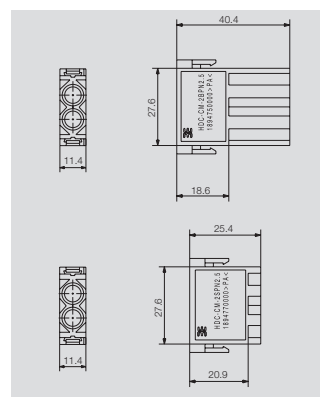

ConCept bus module for screened wires

Concept bus is ideal for transmitting highly sensitive signals in heavy-duty connectors.

Modules of the ConCept heavy-duty connector system offer many functions in a very small space with reliable protection from electromagnetic fields, moisture, dust and extreme mechanical loads.

By combining these with other modules, the power supply and other signals for the field device can be connected in a single plug-in connector.

The **Profibus-DP module with T-Connector function** enables uninterrupted operation of the fieldbus during servicing or when replacing a field device. The fieldbus system no longer has to be switched off, as was the case in the past, because the field device can simply be connected or disconnected during operation using the heavy-duty connector – “plug and play” now available for the first time for fieldbus solutions. The same heavy-duty connector also provides a reliable power supply for the connected fieldbus device.

On one side, Weidmüller uses the robust USB plug as connection system for the Profibus DP modules. This guarantees a high transmission rate of 1.5 Mbit/s and at least 200 plugging cycles. On the other side, screw terminals are used to connect the screened Profibus cables.

Advantages

- Simple screw connection
- Simple screen connection

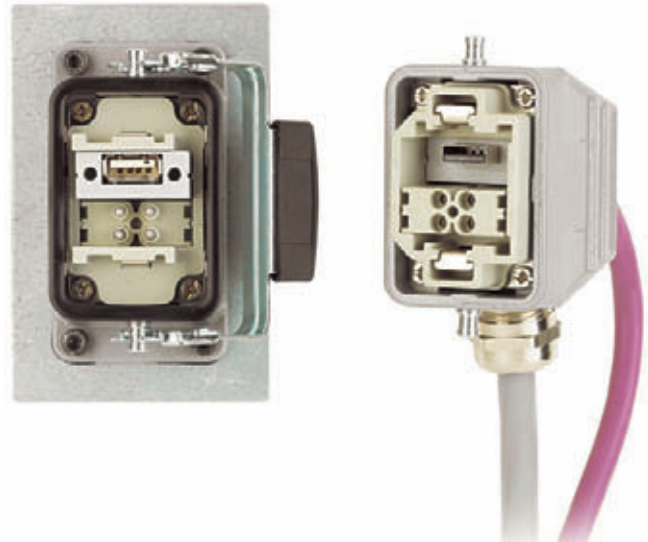

Versions

- Bus connector **HDC CM BUS 4 ...** for screened wires (for connecting 4 wires and screen)



- Bus connector with integrated T-exit **HDC CM BUS 2 ... PDP** for screened wires (Profibus-DP solution = 2 wires and screen)



Technical data

Material data	HDC CM BUS 4 ...	HDC CM BUS 2 ... PDP
Insulation	Glass fibre reinforced PC	
Colour	Grey (similar to RAL 7032)	
Temperature range	-20°C to +85°C	

System characteristics		
Connection technology	Screw connection	
No. of poles	4 + screen	2 + screen
Conductor capacity	0.08 ... 1.5 mm ² AWG 28 ... 16	As Profibus DP
Stripping length	5 mm	
Clamping capacity (outer diameter of cable screen)	2.1 ... 7 mm	
Stripped sheath length	19 mm	

Rated data to VDE 0627		
Rated current	1 A	
Rated voltage	30 V	
Transmission rate	max. 1.5 Mbit/s	

Clamping torques		
Screen clip	0.5 – 0.6 Nm	
PCB terminal	0.2 – 0.3 Nm	

- Assembly instructions**
- Use wire end ferrules
 - Clamp screen braid under clip
 - Use specified torque settings
 - Place module at the far end of the frame with the connection side to the outside

Note: Also take note of the assembly instructions enclosed with the product.

Derating curves

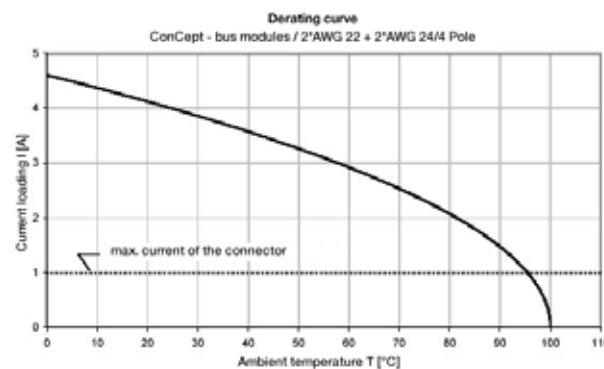
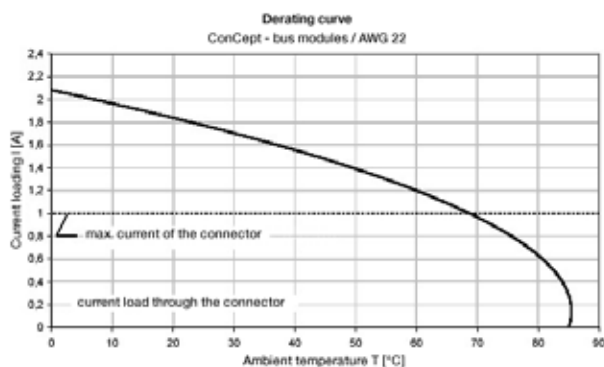

ConCept bus modules

Bus connectors

4 poles

Technical data

Rated voltage	1 A
Rated current	30 V
Qty	5

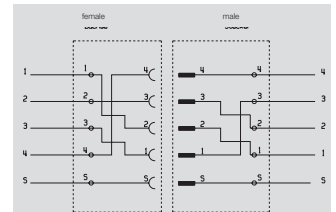

male module

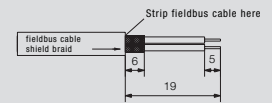

female module

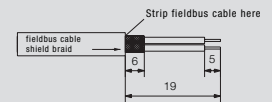

Information

Module



Insert	Type	Order No.
male	HDC CM BUS 4SS	1814310000
female	HDC CM BUS 4BS	1814300000

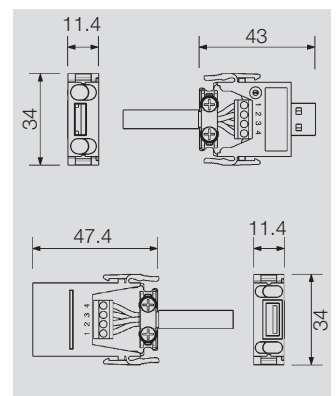

Bus connector with integrated T-exit

2 poles

Technical data

Rated voltage	1 A
Rated current	30 V
Qty	5

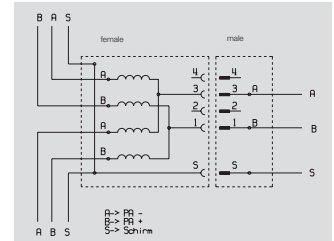

male module

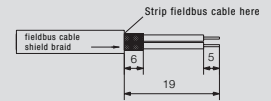

female module

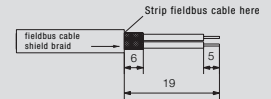

Information

The Profibus topology is the line structure. The branches (T-pieces) connect the individual field devices or remote I/Os to the bus cable. The length of the spur depends on the transmission rate and should be as short as possible. IEC 61158 specifies that with a transmission rate of 1500 kbit/s per segment, spur lengths of up to 6.6 m are permitted. Source: Profibus Directive, Order No. 2.111 Version 1.0

Module



Insert	Type	Order No.
male	HDC CM BUS.2SS PDP A	1806060000
female	HDC CM BUS.2BS T PDP C	1806030000

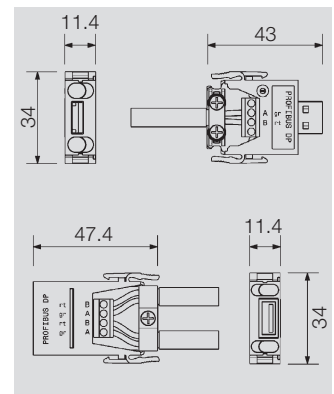

ConCept bus modules

ConCept system bus

Shielded module with additional 4 power contacts



Technical data

Tests	DIN EN 61984 IEC 60664
No. contacts	1 or 4 poles for signal transmission; additional 4 power contacts
Conductor connection system	Crimp
Rated current signal / power contacts	10 A / 20 A
Rated voltage signal / power contacts	50 V / 400 V
Shield	Shield connected to contact carrier using cable clamp
Outside diameter of shielded cable	3 to 6 mm or 6 to 9,5 mm
Degree of pollution	3
Rated impulse withstand voltage signal / power	0.8 kV/ 6 kV
Contact resistance	
– Crimp version	< 2 mΩ
Conductor clamping ranges	
– Crimp version	0.5 mm² ... 2.5 mm² signal contacts 0.5 mm² ... 4 mm² power contacts AWG 26 ... 14 signal contacts AWG 18 ... 12 power contacts
Contact material	Copper alloy
Contact carrier	Zinc alloy
Surface	
– Crimp connection	3 µm Ag or 0.8 µm Au signal contacts 3 µm Ag power contacts
Temperature range	–40°C ... + 125°C
Flammability to UL 94	V-0
Material – module	Glass-fibre reinforced PC (in UL list and approved for railway applications)
Earthing	Leading earth contact through module frame; single-sided PE terminal; double-sided possible as option
Note	

Modules

Shielded module



Designation	Order No.
HDC CM Bus F2	1908490000

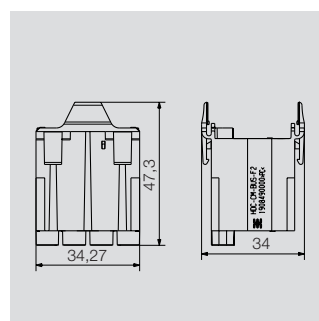

Shielded module



Designation	Order No.
HDC CM Bus M2	1908530000

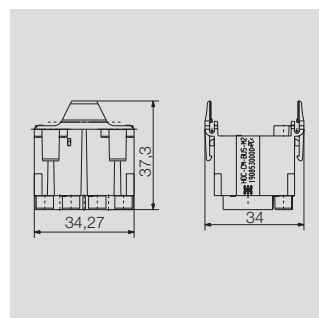

Shielded module

Designation	Order No.
HDC CM Bus GCA	1908510000

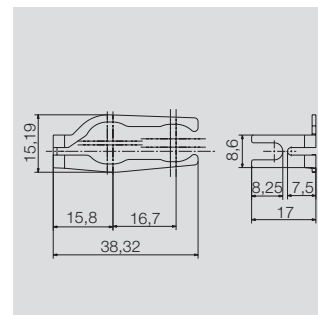

Shielded module

Designation	Order No.
HDC CM Bus F4 CT	1908500000

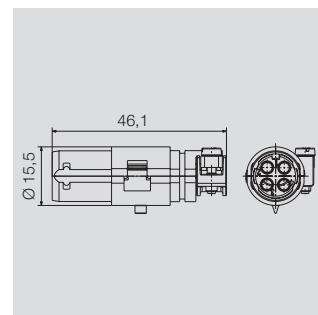

Shielded module

Designation	Order No.
HDC CM Bus M4 CT	1908480000

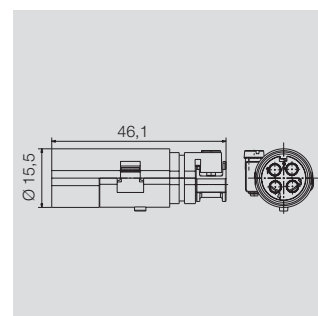

Shielded module

Designation	Order No.
HDC CM Bus F1 CT	1908540000

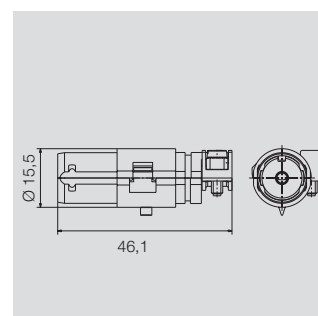

Shielded module

Designation	Order No.
HDC CM Bus M1 CT	1908520000

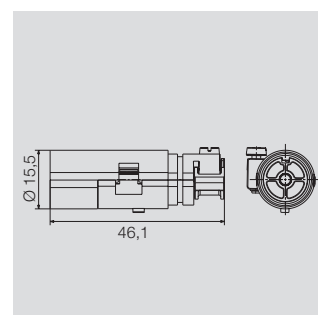

ConCept construction frame

Size 3

Frame



Frame



Frame	Designation	Order No.
Male	HDC CF 6 2M	1758440000
Female	HDC CF 6 2F	1758450000

Note For 2 modules

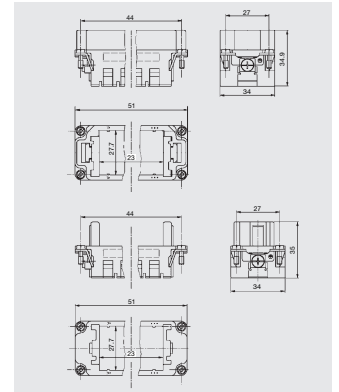

Selection of Housings RockStar® IP65
Size 3



Hood

Hood, Cable Entry sideways



a	Version	Cover	b (mm)	Designation	Order No.
M 20	with thread		52	HDC 06B TSLU 1M20G	1788100000
M 20	with thread		52	HDC 06B TSLU 1M20G	1805930000
M 25	with thread		52	HDC 06B TSLU 1M25G	1788090000
M 25	with thread		72	HDC 16D TSLU 1M25G	1787480000

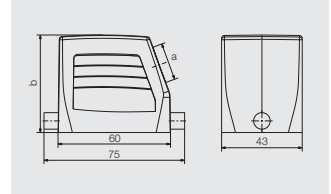

Hood, Cable Entry at top



a	Version	Cover	b (mm)	Designation	Order No.
M 20	with thread		52	HDC 06B TOLU 1M20G	1788120000
M 25	with thread		52	HDC 06B TOLU 1M25G	1788110000
M 25	with thread		72	HDC 16D TOLU 1M25G	1787500000
M 32	with thread		72	HDC 16D TOLU 1M32G	1787490000

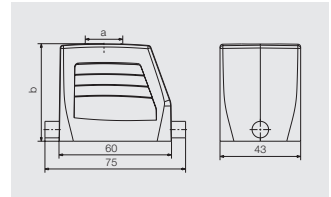

Cover



Version	Designation	Order No.
for hoods	HDC 06B DMDL 1LB	1665210000

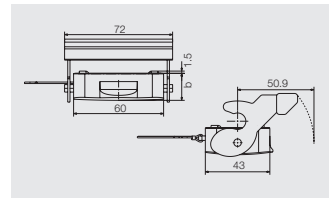

Base

Bulkhead housing



Version	Cover	b (mm)	Designation	Order No.
	with cover	47	HDC 06B ADLU	1202500000
		29	HDC 06B ALU	1202100000

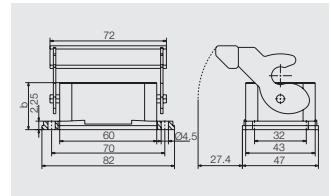

Base housing



a	Version	Cover	b (mm)	Designation	Order No.
M 20	with thread	with cover	72	HDC 06B SDLU 2M20G	1788170000
M 25	with thread	with cover	72	HDC 06B SDLU 2M25G	1788160000
M 20	with thread		54	HDC 06B SLU 2M20G	1788140000
M 25	with thread		54	HDC 06B SLU 2M25G	1788130000

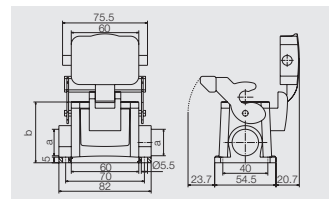

Cover



Version	Designation	Order No.
for bases	HDC 06B DODL 2BO	1665200000

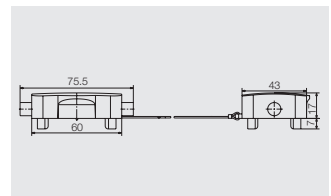

ConCept construction frame

Size 4

Frame



Frame



Frame	Designation	Order No.
Male	HDC CF 10 3M	1758460000
Female	HDC CF 10 3F	1758470000

Note For 3 modules

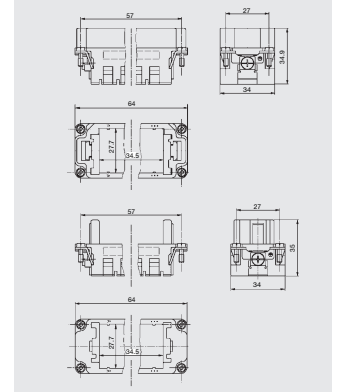

Selection of Housings RockStar® IP65 Size 4



Hood

Hood, Cable Entry sideways



a	Version	Cover	b (mm)	Designation	Order No.
M 20	with thread		52	HDC 10B TSBU 1M20G	1787560000
M 25	with thread		52	HDC 10B TSBU 1M25G	1787550000
M 25	with thread		72	HDC 24D TSBU 1M25G	1787240000
M 32	with thread		72	HDC 24D TSBU 1M32G	1787230000

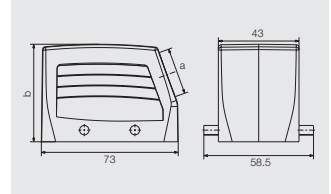

Hood, Cable Entry at top



a	Version	Cover	b (mm)	Designation	Order No.
M 20	with thread		52	HDC 10B TOBU 1M20G	1787600000
M 25	with thread		52	HDC 10B TOBU 1M25G	1787590000
M 25	with thread		72	HDC 24D TOBU 1M25G	1787300000
M 32	with thread		72	HDC 24D TOBU 1M32G	1787290000

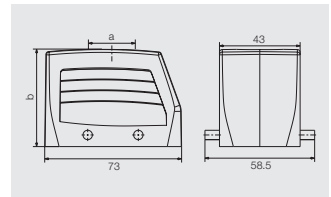

Cover



Version	Designation	Order No.
for hoods	HDC 10B DMDQ 2QB	1665240000

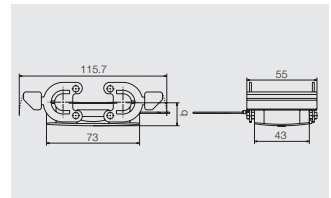

Base

Bulkhead housing



Version	Cover	b (mm)	Designation	Order No.
		29.3	HDC 10B ABU	1205000000

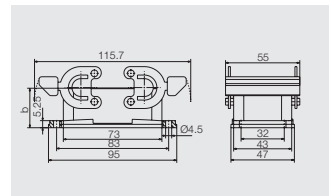

Base housing



a	Version	Cover	b (mm)	Designation	Order No.
M 20	with thread		57	HDC 10B SBU 2M20G	1787640000
M 25	with thread		57	HDC 10B SBU 2M25G	1787630000
M 25	with thread		74	HDC 24D SBU 2M25G	1787350000
M 32	with thread		74	HDC 24D SBU 2M32G	1787360000

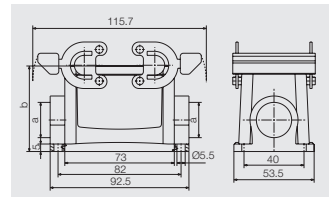

Coupling hood



a	Version	Cover	b (mm)	Designation	Order No.
M 20	with thread		55	HDC 10B KBU 1M20G	1787720000

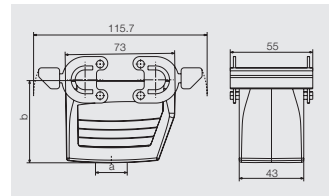

Cover



Version	Designation	Order No.
for bases	HDC 10B DODQ 4BO	1665230000

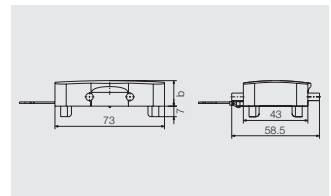

ConCept construction frame

Size 6

Frame



Frame



Frame	Designation	Order No.
Male	HDC CF 16 5M	1758480000
Female	HDC CF 16 5F	1758490000

Note For 5 modules

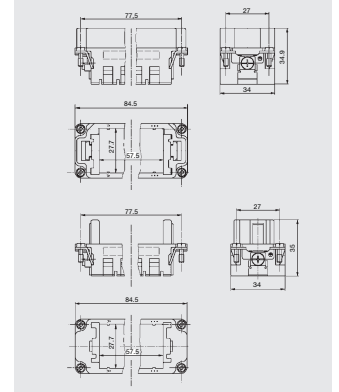

Selection of Housings RockStar® IP65
Size 6



Hood

Hood, Cable Entry sideways



a	Version	Cover	b (mm)	Designation	Order No.
M 25	with thread		61	HDC 16B TSBU 1M25G	1788180000
M 25	with thread		76	HDC 40D TSBU 1M25G	1787010000
M 32	with thread		76	HDC 40D TSBU 1M32G	1787000000

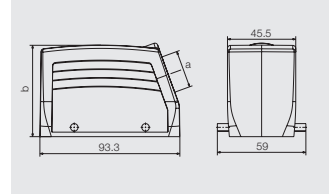

Hood, Cable Entry at top



a	Version	Cover	b (mm)	Designation	Order No.
M 25	with thread		61	HDC 16B TOBU 1M25G	1788210000
M 25	with thread		76	HDC 40D TOBU 1M25G	1787070000
M 32	with thread		76	HDC 40D TOBU 1M32G	1787060000

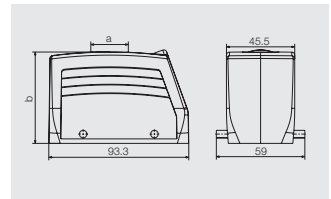

Cover

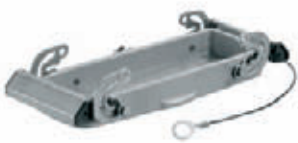

Version	Designation	Order No.
for hoods	HDC 16B DMDQ 2QB	1665270000

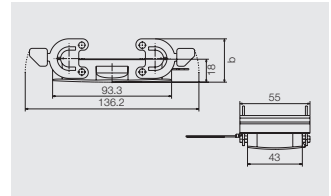

Base

Bulkhead housing



Version	Cover	b (mm)	Designation	Order No.
		29	HDC 16B ABU	1208600000

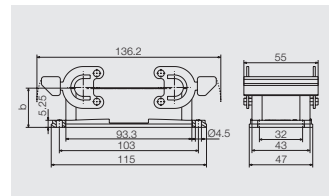

Base housing



a	Version	Cover	b (mm)	Designation	Order No.
M 25	with thread		64	HDC 16B SBU 2M25G	1788240000
M 25	with thread		84	HDC 40D SBU 2M25G	1787120000
M 32	with thread		84	HDC 40D SBU 2M32G	1787110000

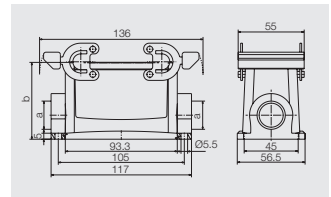

Coupling hood



a	Version	Cover	b (mm)	Designation	Order No.
M 25	with thread		79	HDC 40D KBU 1M25G	1787200000
M 32	with thread		79	HDC 40D KBU 1M32G	1787190000

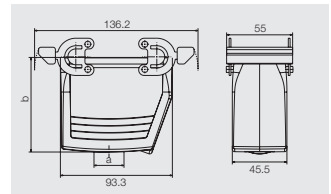

Cover



Version	Designation	Order No.
for bases	HDC 16B DODQ 4BO	1665260000

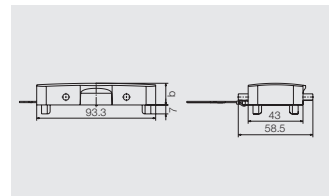

ConCept construction frame

Size 8

Frame



Frame



Frame	Designation	Order No.
Male	HDC CF 24 7M	1758500000
Female	HDC CF 24 7F	1758510000

Note For 7 modules

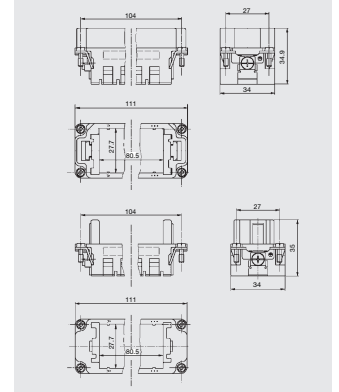

Selection of Housings RockStar® IP65
Size 8



RockStar® ConCept modular system

Hood

Hood, Cable Entry sideways



a	Version	Cover	b (mm)	Designation	Order No.
M 25	with thread		61	HDC 24B TSBU 1M25G	1787760000
M 32	with thread		61	HDC 24B TSBU 1M32G	1787750000
M 25	with thread		76	HDC 64D TSBU 1M25G	1786780000
M 32	with thread		76	HDC 64D TSBU 1M32G	1786770000

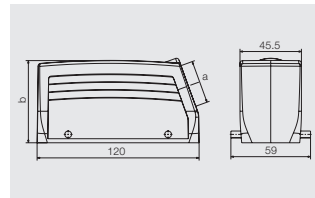

Hood, Cable Entry at top



a	Version	Cover	b (mm)	Designation	Order No.
M 25	with thread		61	HDC 24B TOBU 1M25G	1787820000
M 32	with thread		61	HDC 24B TOBU 1M32G	1787810000
M 32	with thread		76	HDC 64D TOBU 1M32G	1786830000

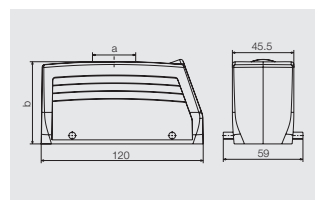

Cover

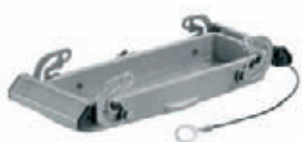

Version	Designation	Order No.
for hoods	HDC 24B DMDQ 2QB	1665640000

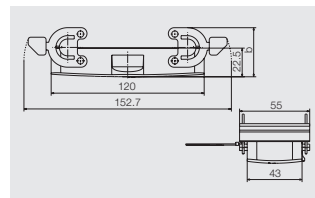

Base

Bulkhead housing



Version	Cover	b (mm)	Designation	Order No.
		29.3	HDC 24B ABU	1212400000

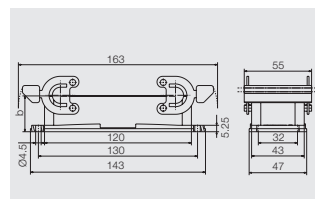

Base housing



a	Version	Cover	b (mm)	Designation	Order No.
M 25	with thread		64	HDC 24B SBU 2M25G	1787870000
M 25	with thread		84	HDC 64D SBU 2M25G	1786890000
M 32	with thread		84	HDC 64D SBU 2M32G	1786880000

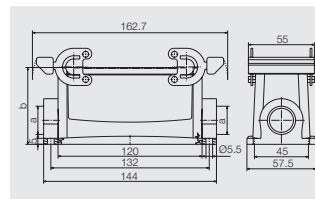

Coupling hood



a	Version	Cover	b (mm)	Designation	Order No.
M 25	with thread		65	HDC 24B KBU 1M25G	1787920000
M 32	with thread		79	HDC 64D KBU 1M32G	1786960000

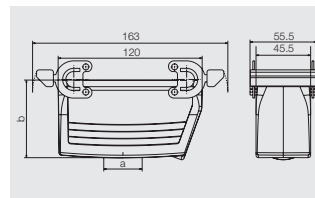

Cover



Version	Designation	Order No.
for bases	HDC 24B DODQ 4BO	1665630000

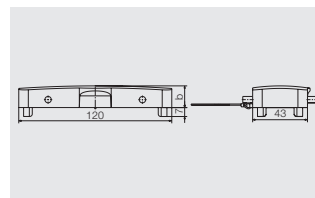

ConCept construction frame

Size 10

Frame



Frame



Frame	Designation	Order No.
Female	HDC CF 16 5M 2	1758530000
Male	HDC CF 16 5F 2	1758520000

Note for 2 x 5 modules please use 2 of the mentioned inserts

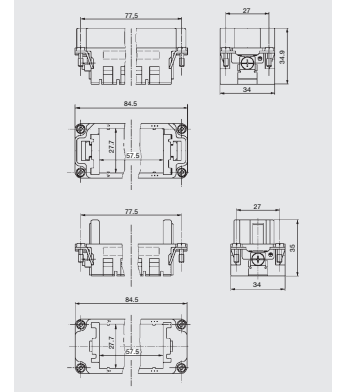

Selection of Housings RockStar® IP65
Size 10



Hood

Hood, Cable Entry sideways



a	Version	Cover	b (mm)	Designation	Order No.
M 32	with thread		79	HDC 32B TSLU 1M32G	1788420000

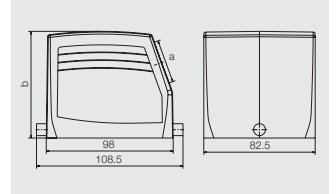

Base

Bulkhead housing



Version	Cover	b (mm)	Designation	Order No.
	with cover	55	HDC 32B ADLU	1219800000
		38	HDC 32B ALU	1219500000

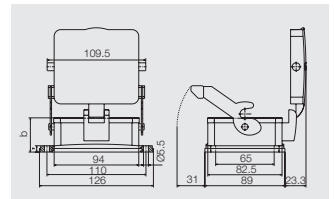

Base housing



a	Version	Cover	b (mm)	Designation	Order No.
M 32	with thread	with cover	96	HDC 32B SDLU 2M32G	1788490000
M 32	with thread		79	HDC 32B SLU 2M32G	1788470000

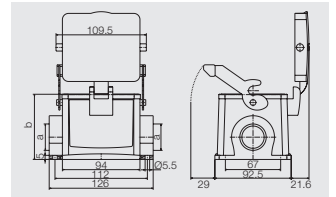

Coupling hood



a	Version	Cover	b (mm)	Designation	Order No.
M 32	with thread		83	HDC 32B KLU 1M32G	1788500000

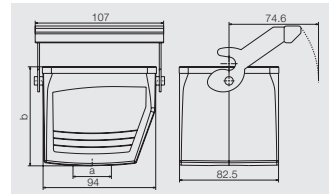

ConCept construction frame

Size 12

Frame



Frame



Frame	Designation	Order No.
Male	HDC CF 24 7M 2	1758540000
Female	HDC CF 24 7F 2	1758550000

Note for 2 x 7 modules please use 2 of the mentioned inserts

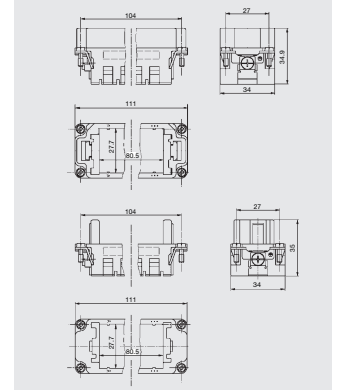

**Selection of Housings RockStar® IP65
Size 12**



Hood

Hood, Cable Entry sideways



a	Version	Cover	b (mm)	Designation	Order No.
M 32	with thread	94	HDC 48B TSLU 1M32G	1788320000	
M 40	with thread	94	HDC 48B TSLU 1M40G	1788310000	
M 50	with thread	94	HDC 48B TSLU 1M50G	1788300000	

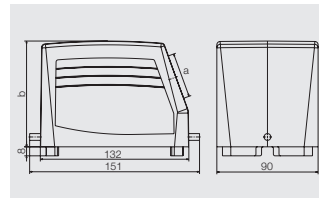

Hood, Cable Entry at top



a	Version	Cover	b (mm)	Designation	Order No.
M 32	with thread	94	HDC 48B TOLU 1M32G	1788350000	
M 50	with thread	94	HDC 48B TOLU 1M50G	1788330000	

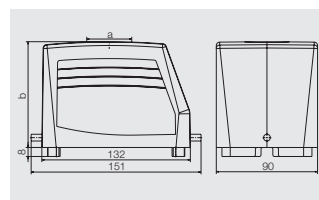

Base

Bulkhead housing



Version	Cover	b (mm)	Designation	Order No.
	with cover	62	HDC 48B ADLU	1222900000

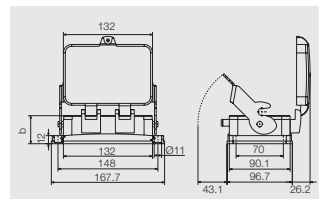

Base housing

a	Version	Cover	b (mm)	Designation	Order No.
M 32	with thread	with cover	120	HDC 48B SDLU 2M32G	1788390000
M 32	with thread		100	HDC 48B SLU 2M32G	1788370000
M 40	with thread		100	HDC 48B SLU 2M40G	1788360000

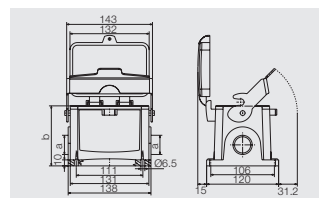

Coupling frame for ConCept modules

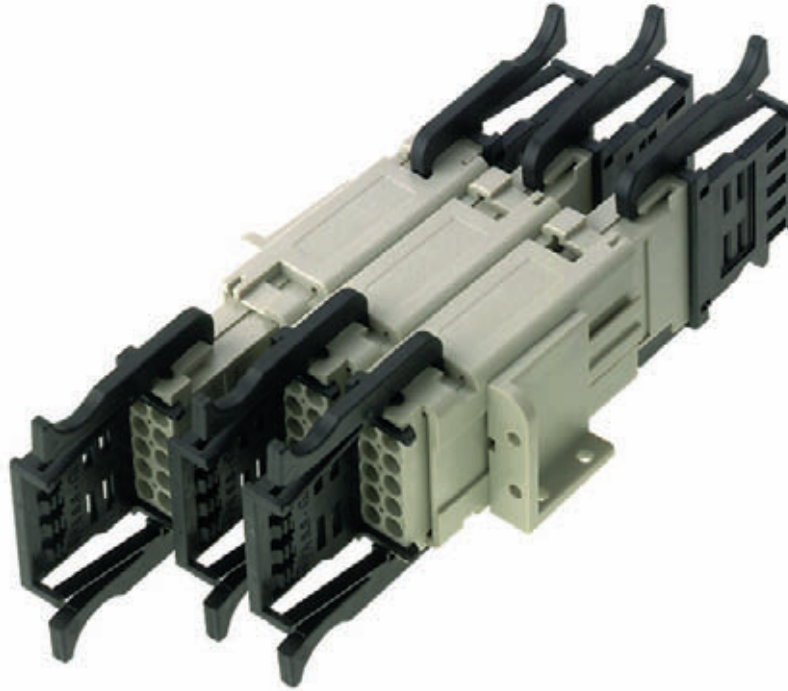

The ModuFlex C coupling system together with modules from the ConCept connector system provides a flexible and low-cost solution for indoor applications (IP20 zone).

ConCept 3–20-pin male and female modules of the same pin number and design can be mounted in the coupling frame. Up to 5 coupling frames can be combined into a block with the help of the tongue-and-groove locking system. The coupling frames can also be locked onto TS32 and TS35 rail by using the mounting feet.

Each individual module can be individually plugged in and released. Thanks to the optional extractor / strain relief tool and the snap-on mounting bracket, ModuFlex C-coupling frames and the male and female modules of the ConCept system allow a wide range of combinations for all possible connector configurations.

ModuFlex C

Coupling frame



- Max. 5 coupling frames in a row
- Protection from incorrect connection
- Force required to withdraw a single module from the coupling frame >170 N

Note:
The CM3-HV modules are not suitable for use in the coupling frame.

Mounting bracket / mounting foot

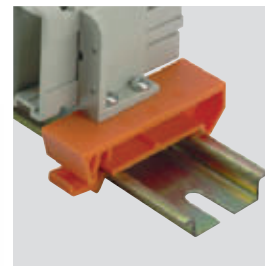

- Mounting bracket**
- For fixing the coupling frames to a flat surface and to MOFU mounting foot
 - Hole diameter 3 mm

- Mounting foot**
- For fixing coupling frames to TS35x7.5 and TS35x15 mounting rails using mounting brackets

Technical data **C-CR**

	Coupling frame
Insulation	PC
Colour	grey (RAL 7032)
Temperature range	-40 ... +120°C
Flammability class to UL 94	V-0

Ordering data

Type	Qty	Order No.
ModuFlex C-CR grau	10	1746060000

Technical data **C-MW** **MOFU**

	Mounting bracket	Mounting foot
Insulation	PC	PA
Colour	grey (RAL 7032)	orange
Temperature range	-40 ... +120°C	-40 ... +120°C
Flammability class to UL 94	V-0	V-2

Ordering data

Type		Qty	Order No.
ModuFlex C-MW	Mounting bracket	10	1746070000
MOFU	Mounting foot	20	0495660000

Accessories

Type	Qty	Order No.
<p>Crosshead screw for fastening the coupling to the mounting foot, to front and back panel and to a flat surface</p> <p>PTSC KB 30 x 6</p>	100	1766120000
<p>Spacer pin M3 x 27 and clamping screws M3 x 8 in set. For mounting the coupling to flat panels. 1 pack contains 80 screws and 40 spacer pins, separately packaged.</p> <p>ABST.BOLZM3X27+KLSC-KIT</p>	1	1766130000

Module extractor and strain relief tool



Coupling frame – sets

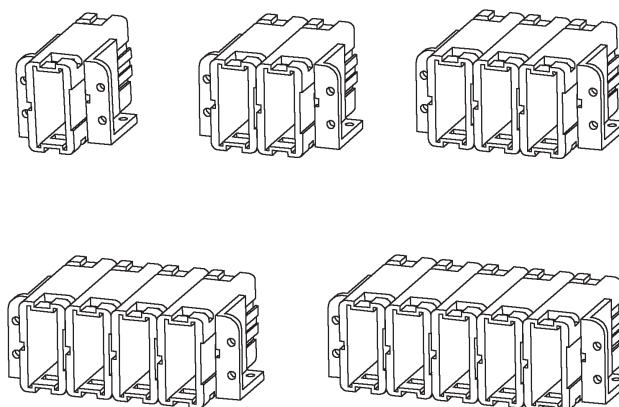

- Set consists of:
- 1 – 5 coupling frames
 - 1 right and 1 left mounting bracket

Technical data

C-MH/ZE

Module extractor and strain relief tool	
Insulation	PA
Colour	black
Temperature range	-40 ... +120°C
Flammability class to UL 94	V-2

Ordering data

Type	Qty	Order No.
ModuFlex C-MH/ZE black	10	1752970000

Technical data

Mounting bracket		Mounting foot
Insulation	PC	PA
Colour	grey (RAL 7032)	orange
Temperature range	-40 ... +120°C	-40 ... +120°C
Flammability class to UL 94	V-0	V-2

Ordering data

Type	No. of coupling frames	Qty	Order No.
ModuFlex C-KITo.M.MW-1F	1	1	1765570000
ModuFlex C-KITo.M.MW-2F	2	1	1765580000
ModuFlex C-KITo.M.MW-3F	3	1	1765590000
ModuFlex C-KITo.M.MW-4F	4	1	1765600000
ModuFlex C-KITo.M.MW-5F	5	1	1765610000

Accessories

Type	Qty	Order No.
<p>Crosshead screw for fastening the coupling to the mounting foot, to front and back panel and to a flat surface</p> <p>PTSC KB 30 x 6</p>	100	1766120000
<p>Spacer pin M3 x 27 and clamping screws M3 x 8 in set. For mounting the coupling to flat panels. 1 pack contains 80 screws and 40 spacer pins, separately packaged.</p> <p>ABST.BOLZM3X27+KLSC-KIT</p>	1	1766130000

RockStar® Housings IP65 / NEMA 4X

RockStar® Housings IP65 / NEMA 4X	Overview	D.2
	RockStar® Housings IP65 / NEMA 4X	D.4

RockStar® Housings IP65 / NEMA 4X

D



Weidmüller's RockStar® IP 65 / NEMA 4X housings are your first choice when it comes to industrial housings in IP 65 class of protection.

Features:

- Housing of cast aluminium alloy or thermoplastic
- All fittings (clamps and pins) of rust proof stainless steel

Typical applications:

- general mechanical and plant engineering
- rail engineering
- conveying and transport technology
- packing machines
- crane construction and industrial robots
- toolmaking and special-purpose machine building
- fairground rides
- stage and lighting equipment

Various versions:

- different sizes
- different housing types
- different types of construction
- different locking systems
- different cable entries
- with or without cover

Their advantages:

- multiple plugging and unplugging of electrical connections
- reliable assembly under time pressure
- corrosion protection
- IP65 for both aluminium and plastic housings
- NEMA 4X for both aluminium and plastic housings

RockStar® Housings IP65 / NEMA 4X

Plastic housing

Size 1

Hood



Hood, Cable Entry sideways



a	Version	Cover	b (mm)	Designation	Order No.
M 20	with thread		49,2	HDC 07A TWLU 1M20G	1788510000
PG 11	with thread		49,2	HDC 07A TWLU 1PG11G	1652400000

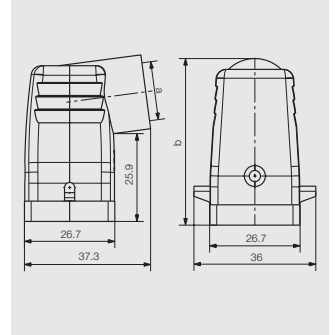

D

Hood, Cable Entry at top



a	Version	Cover	b (mm)	Designation	Order No.
M 20	with thread		50	HDC 07A TOLU 1M20G	1788520000
PG 11	with thread		50	HDC 07A TOLU 1PG11G	1652380000

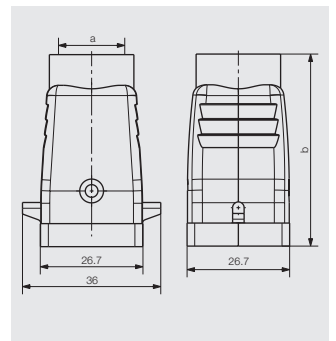

Plastic housing

Size 1

Base



Bulkhead housing



Version	Cover	b (mm)	Designation	Order No.
		23	HDC 07A ALU	1652410000
angled		26.7	HDC 07A AWLU	1652420000

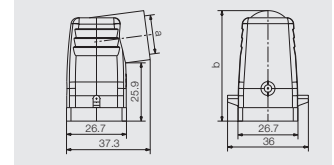

Base housing



a	Version	Cover	b (mm)	Designation	Order No.
M 20	with thread		25.8	HDC 07A SLU 1M20G	1788530000
PG 11	w. sleeve		25.8	HDC 07A SLU 1PG11S	1652440000

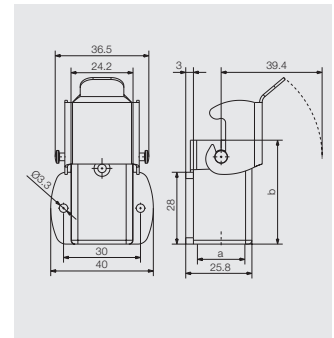

Coupling hood



a	Version	Cover	b (mm)	Designation	Order No.
M 20	with thread		53.5	HDC 07A KOLU 1M20G	1788540000
PG 11	with thread		53.5	HDC 07A KOLU 1PG11G	1652460000

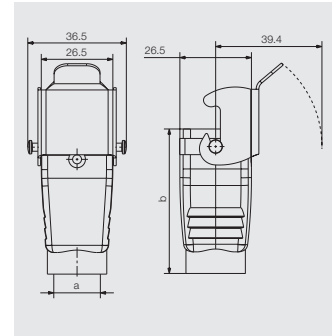

Screw Mounting Housing



a	Version	Cover	b (mm)	Designation	Order No.
PG 13,5	with thread		54	HDC 07A ELU 1PG13G	1900990000

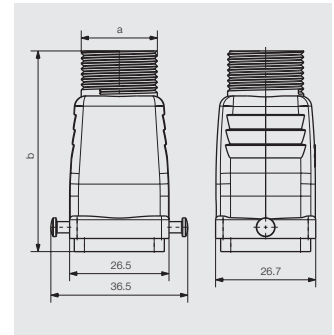

Cover



Version	Designation	Order No.
for female insert	HDC 07A DMDL 2BO	1665770000
for male insert	HDC 07A DODL 2BO	1665760000

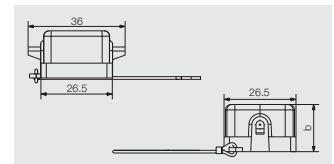

RockStar® Housings IP65 / NEMA 4X

Metal housing

Size 1

Hood



Hood, Cable Entry sideways



a	Version	Cover	b (mm)	Designation	Order No.
M 20	with thread		49,2	HDC 04A TWLU 1M20G	1788810000
PG 11	with thread		49,2	HDC 04A TWLU 1PG11G	1652480000
PG 11	with thread		49,2	HDC 04A TWLU 1PG11G EXI	1900310000

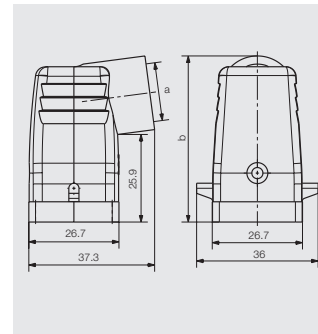

D

Hood, Cable Entry at top



a	Version	Cover	b (mm)	Designation	Order No.
M 20	with thread		50	HDC 04A TOLU 1M20G	1788820000
PG 11	with thread		50	HDC 04A TOLU 1PG11G	1652470000
PG 11	with thread		50	HDC 04A TOLU 1PG11G EXI	1900280000

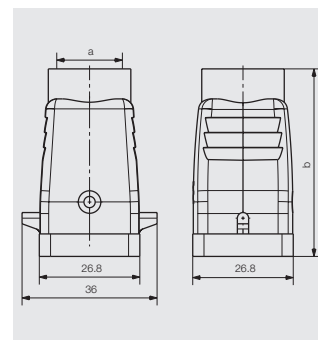

Metal housing

Size 1

Base



Bulkhead housing



Version	Cover	b (mm)	Designation	Order No.
		23	HDC 04A ALU	1497600000
with thread		23	HDC 04A ALU EXI	1899870000
with thread		26.7	HDC 04A AWLU EXI	1899890000

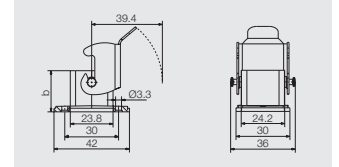

Base housing



a	Version	Cover	b (mm)	Designation	Order No.
M 20	with thread		25.8	HDC 04A SLU 1M20G	1788830000
PG 11	with thread		25.8	HDC 04A SLU 1PG11G	1652490000
PG 11	with thread		25.8	HDC 04A SLU 1PG11G EXI	1899800000

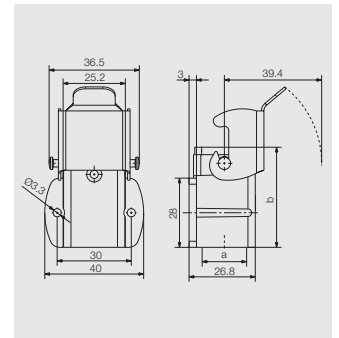

Coupling hood



a	Version	Cover	b (mm)	Designation	Order No.
M 20	with thread		53.5	HDC 04A KOLU 1M20G	1788840000
PG 11	with thread		53.5	HDC 04A KOLU 1PG11G	1652500000
PG 11	with thread		53.5	HDC 04A KOLU 1PG11G EXI	1899920000

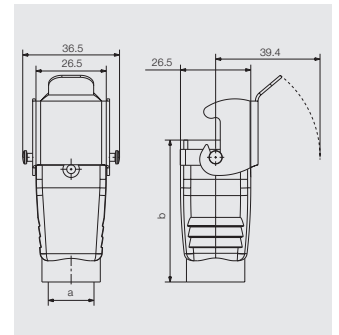

Screw Mounting Housing



a	Version	Cover	b (mm)	Designation	Order No.
M 20	with thread		54	HDC 04A ELU 1M20G	1900320000
PG 13,5	with thread		54	HDC 04A ELU 1PG13G	1900330000
PG 13,5	with thread		54	HDC 04A ELU 1PG13G EXI	1900350000

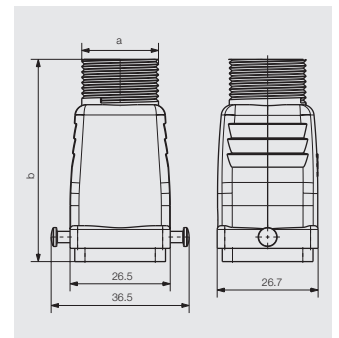

Cover



Version	Designation	Order No.
for female insert	HDC 04A DMDL 2BO	1665750000
for male insert	HDC 04A DODL 2BO	1665740000

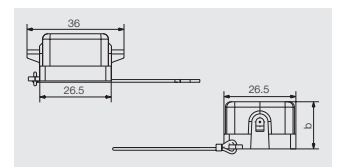

RockStar® Housings IP65 / NEMA 4X

End locking, lower side

Size 2

Hood



Hood, Cable Entry sideways



a	Version	Cover	b (mm)	Designation	Order No.
M 20	with thread		68	HDC 15A TSLU 1M20G	1788860000
M 25	with thread		68	HDC 15A TSLU 1M25G	1788850000
PG 16	with thread		54	HDC 10A TSLU 1PG16G	1663810000
PG 16	with thread		68	HDC 15A TSLU 1PG16G	1663850000
PG 21	with thread		68	HDC 15A TSLU 1PG21G	1663870000

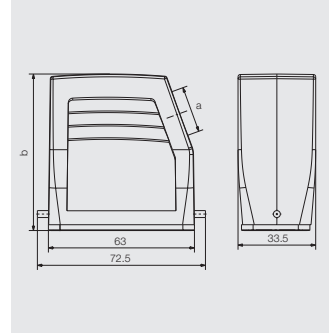

D

Hood, Cable Entry at top



a	Version	Cover	b (mm)	Designation	Order No.
M 20	with thread		54	HDC 10A TOLU 1M20G	1788620000
M 25	with thread		54	HDC 10A TOLU 1M25G	1788610000
PG 16	with thread		54	HDC 10A TOLU 1PG16G	1663930000
PG 21	with thread		68	HDC 15A TOLU 1PG21G	1663990000

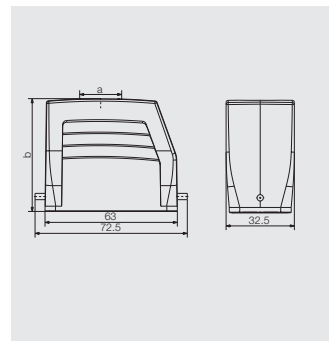

Cover



Version	Designation	Order No.
for hoods	HDC 10A DODL 1LB	1665890000

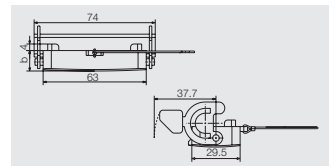

End locking, lower side

Size 2



Base

Bulkhead housing



Version	Cover	b (mm)	Designation	Order No.
	with cover	37.5	HDC 10A ADLU	1664060000
		25	HDC 10A ALU	1664040000

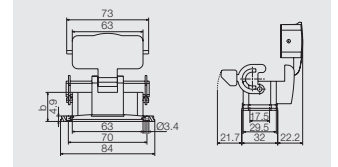

Base housing



a	Version	Cover	b (mm)	Designation	Order No.
M 20	with thread		57	HDC 10A SLU 1M20G	1901100000
M 20	with thread	with cover	69.5	HDC 10A SDLU 1M20G	1901010000
M 20	with thread		57	HDC 10A SLU 2M20G	1788640000
M 20	with thread	with cover	69.5	HDC 10A SDLU 2M20G	1788660000
M 25	with thread		57	HDC 10A SLU 1M25G	1901160000
M 25	with thread	with cover	69.5	HDC 10A SDLU 1M25G	1901040000
M 25	with thread		57	HDC 10A SLU 2M25G	1788630000
M 25	with thread	with cover	69.5	HDC 10A SDLU 2M25G	1788650000
PG 16	with thread		57	HDC 10A SLU 1PG16G	1664170000
PG 16	with thread	with cover	69.5	HDC 10A SDLU 1PG16G	1664410000
PG 16	with thread		57	HDC 10A SLU 2PG16G	1664190000
PG 16	with thread	with cover	69.5	HDC 10A SDLU 2PG16G	1664420000
PG 21	with thread		57	HDC 10A SLU 1PG21G	1664210000

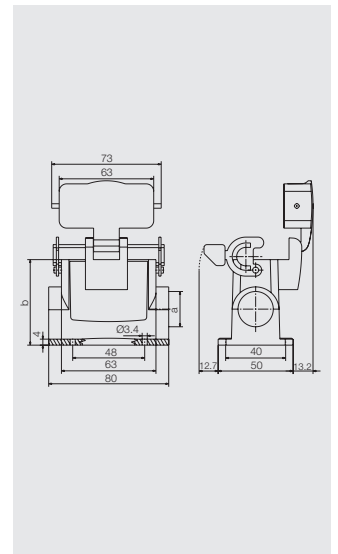

D

Coupling hood



a	Version	Cover	b (mm)	Designation	Order No.
M 25	with thread		48	HDC 10A KLU 1M25G	1788670000
PG 16	with thread		48	HDC 10A KLU 1/PG16G	1664560000
PG 21	with thread		62	HDC 15A KLU 1PG21G	1664630000

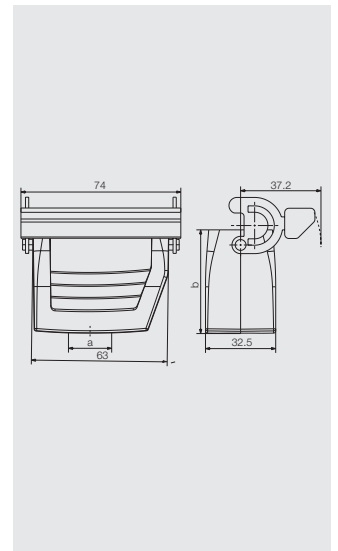

Cover



Version	Designation	Order No.
for bases	HDC 10A DMDL 2BO	1665880000

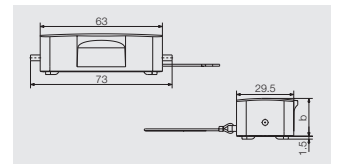

RockStar® Housings IP65 / NEMA 4X

End locking, lower side

Size 3

Hood



Hood, Cable Entry sideways



a	Version	Cover	b (mm)	Designation	Order No.
M 20	with thread		52	HDC 06B TSLU 1M20G	1788100000
M 20	with thread		52	HDC 06B TSLU 1M20G	1805930000
M 25	with thread		52	HDC 06B TSLU 1M25G	1788090000
M 25	with thread		72	HDC 16D TSLU 1M25G	1787480000
M 32	with thread		72	HDC 16D TSLU 1M32G	1787470000
PG 13,5	with thread		52	HDC 06B TSLU 1PG13G	1670530000
PG 16	with thread		52	HDC 06B TSLU 1PG16G	1652520000
PG 21	with thread		72	HDC 16D TSLU 1PG21G	1652560000
PG 29	with thread		72	HDC 16D TSLU 1PG29G	1652580000

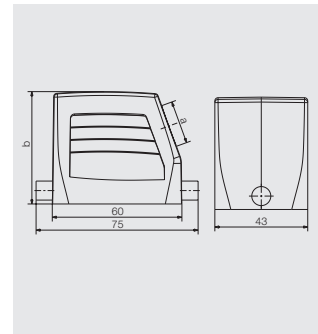

D

Hood, Cable Entry at top



a	Version	Cover	b (mm)	Designation	Order No.
M 20	with thread		52	HDC 06B TOLU 1M20G	1788120000
M 25	with thread		52	HDC 06B TOLU 1M25G	1788110000
M 25	with thread		72	HDC 16D TOLU 1M25G	1787500000
M 32	with thread		72	HDC 16D TOLU 1M32G	1787490000
PG 13,5	with thread		52	HDC 06B TOLU 1PG13G	1670500000
PG 16	with thread		52	HDC 06B TOLU 1PG16G	1652640000
PG 21	with thread		72	HDC 16D TOLU 1PG21G	1652680000
PG 29	with thread		72	HDC 16D TOLU 1PG29G	1652700000

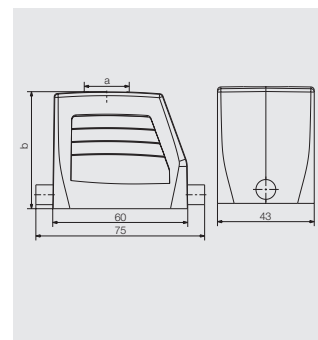

Cover



Version	Designation	Order No.
for hoods	HDC 06B DMDL 1LB	1665210000

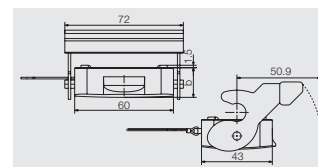

End locking, lower side

Size 3

Base



Bulkhead housing



Version	Cover	b (mm)	Designation	Order No.
		29	HDC 06B ALU	1202100000
	with cover	47	HDC 06B ADLU	1202500000

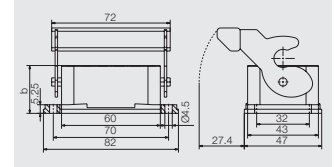

Base housing



a	Version	Cover	b (mm)	Designation	Order No.
M 20	with thread		54	HDC 06B SLU 1M20G	1900460000
M 20	with thread	with cover	72	HDC 06B SDLU 1M20G	1900360000
M 20	with thread		54	HDC 06B SLU 2M20G	1788140000
M 20	with thread	with cover	72	HDC 06B SDLU 2M20G	1788170000
M 25	with thread		54	HDC 06B SLU 1M25G	1900480000
M 25	with thread	with cover	72	HDC 06B SDLU 1M25G	1900380000
M 25	with thread		74	HDC 16D SLU 1M25G	1900880000
M 25	with thread	with cover	92	HDC 16D SDLU 1M25G	1900820000
M 25	with thread		54	HDC 06B SLU 2M25G	1788130000
M 25	with thread	with cover	74	HDC 16D SLU 2M25G	1787520000
M 25	with thread	with cover	92	HDC 16D SDLU 2M25G	1787540000
M 25	with thread	with cover	72	HDC 06B SDLU 2M25G	1788160000
M 32	with thread		74	HDC 16D SLU 1M32G	1900900000
M 32	with thread		74	HDC 16D SLU 2M32G	1787510000
PG 16	with thread		54	HDC 06B SLU 1PG16G	1652750000
PG 16	with thread	with cover	72	HDC 06B SDLU 1PG16G	1652980000
PG 16	with thread		54	HDC 06B SLU 2PG16G	1652760000
PG 16	with thread	with cover	72	HDC 06B SDLU 2PG16G	1652990000
PG 21	with thread		74	HDC 16D SLU 2PG21G	1652840000

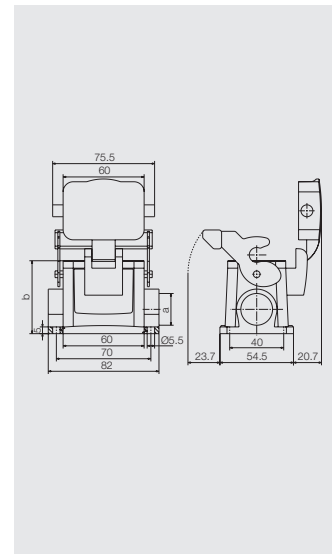

D

Coupling hood



a	Version	Cover	b (mm)	Designation	Order No.
PG 16	with thread		55	HDC 06B KLU 1PG16G	1653200000
PG 21			75	HDC 16D KLU 1/21V	1653230000

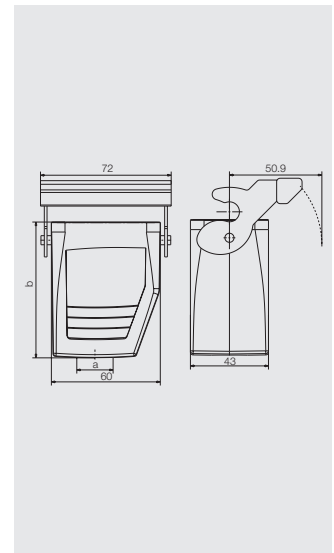

Cover



Version	Designation	Order No.
for bases	HDC 06B DODL 2BO	1665200000

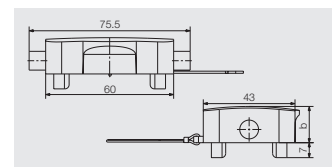

RockStar® Housings IP65 / NEMA 4X

Side locking, lower side

Size 4

Hood



Hood, Cable Entry sideways



a	Version	Cover	b (mm)	Designation	Order No.
M 20	with thread		52	HDC 10B TSBU 1M20G	1787560000
M 25	with thread		52	HDC 10B TSBU 1M25G	1787550000
M 25	with thread		72	HDC 24D TSBU 1M25G	1787240000
M 32	with thread		72	HDC 24D TSBU 1M32G	1787230000
PG 16	with thread		52	HDC 10B TSBU 1PG16G	1654070000
PG 21	with thread		52	HDC 10B TSBU 1PG21G	1654090000
PG 21	with thread		72	HDC 24D TSBU 1PG21G	1654150000
PG 29	with thread		72	HDC 24D TSBU 1PG29G	1654170000

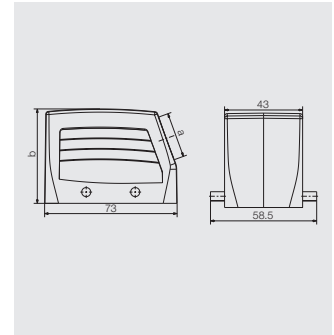

D

Hood, Cable Entry at top



a	Version	Cover	b (mm)	Designation	Order No.
M 20	with thread		52	HDC 10B TOBU 1M20G	1787600000
M 25	with thread		52	HDC 10B TOBU 1M25G	1787590000
M 25	with thread		72	HDC 24D TOBU 1M25G	1787300000
M 32	with thread		72	HDC 24D TOBU 1M32G	1787290000
PG 16	with thread		52	HDC 10B TOBU 1PG16G	1654220000
PG 21	with thread		52	HDC 10B TOBU 1PG21G	1654240000
PG 21	with thread		52	HDC 10B TOBU 1PG21G	1816420000
PG 29	with thread		72	HDC 24D TOBU 1PG29G	1654320000

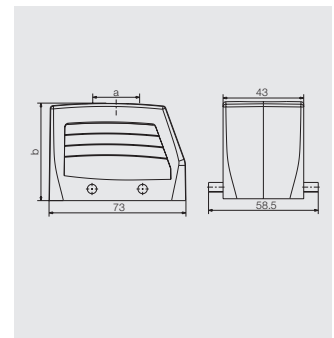

Cover



Version	Designation	Order No.
for hoods	HDC 10B DMDQ 2QB	1665240000

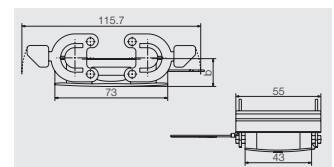

Side locking, lower side

Size 4



Base

Bulkhead housing



Version	Cover	b (mm)	Designation	Order No.
		29.3	HDC 10B ABU	1205000000

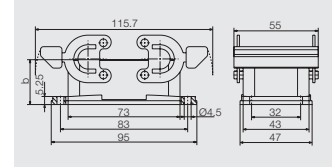

Base housing



a	Version	Cover	b (mm)	Designation	Order No.
M 20	with thread		57	HDC 10B SBU 1M20G	1901360000
M 20	with thread		57	HDC 10B SBU 2M20G	1787640000
M 25	with thread		57	HDC 10B SBU 1M25G	1901370000
M 25	with thread		57	HDC 10B SBU 2M25G	1787630000
M 25	with thread		74	HDC 24D SBU 1M25G	1903210000
M 25	with thread		74	HDC 24D SBU 2M25G	1787350000
M 32	with thread		74	HDC 24D SBU 1M32G	1903220000
M 32	with thread		74	HDC 24D SBU 2M32G	1787360000
PG 16	with thread		57	HDC 10B SBU 1PG16G	1654370000
PG 16	with thread		57	HDC 10B SBU 2PG16G	1654380000
PG 21	with thread		74	HDC 24D SBU 2PG21G	1654450000
PG 29	with thread		74	HDC 24D SBU 1PG29G	1654470000

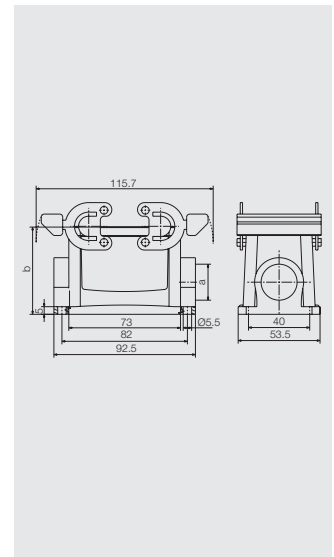

D

Coupling hood



a	Version	Cover	b (mm)	Designation	Order No.
M 20	with thread		55	HDC 10B KBU 1M20G	1787720000
PG 16	with thread		55	HDC 10B KBU 1PG16G	1654580000

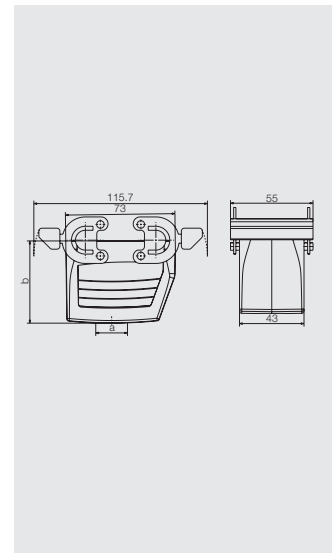

Cover



Version	Designation	Order No.
for bases	HDC 10B DODQ 4B0	1665230000

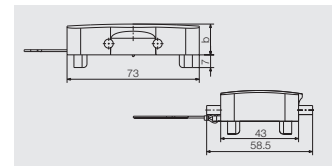

RockStar® Housings IP65 / NEMA 4X

End locking, lower side

Size 4

Hood



Hood, Cable Entry sideways



a	Version	Cover	b (mm)	Designation	Order No.
M 25	with thread	52	HDC 10B TSLU 1M25G	1787580000	
M 25	with thread	72	HDC 24D TSLU 1M25G	1787280000	
M 32	with thread	72	HDC 24D TSLU 1M32G	1787270000	
PG 16	with thread	52	HDC 10B TSLU 1PG16G	1655210000	
PG 21	with thread	72	HDC 24D TSLU 1PG21G	1655250000	
PG 29	with thread	72	HDC 24D TSLU 1PG29G	1655270000	

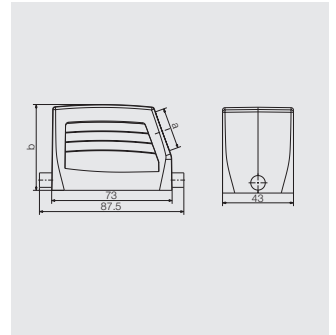

D

Hood, Cable Entry at top



a	Version	Cover	b (mm)	Designation	Order No.
M 25	with thread	52	HDC 10B TOLU 1M25G	1787620000	
M 25	with thread	72	HDC 24D TOLU 1M25G	1787340000	
M 32	with thread	72	HDC 24D TOLU 1M32G	1787330000	
PG 16	with thread	52	HDC 10B TOLU 1PG16G	1655320000	
PG 21	with thread	72	HDC 24D TOLU 1PG21G	1655360000	
PG 29	with thread	72	HDC 24D TOLU 1PG29G	1655380000	

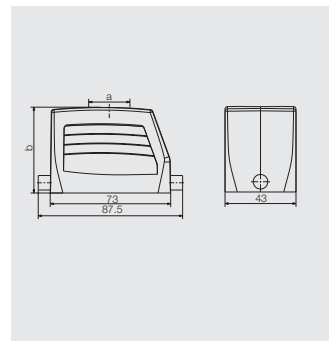

End locking, lower side

Size 4

Base



Bulkhead housing



Version	Cover	b (mm)	Designation	Order No.
	with cover	51.6	HDC 10B ADLU	1206500000
		29.3	HDC 10B ALU	1206100000

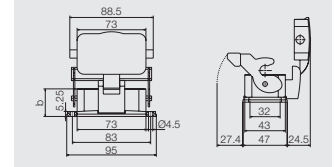

Base housing



a	Version	Cover	b (mm)	Designation	Order No.
M 20	with thread		57	HDC 10B SLU 1M20G	1901620000
M 20	with thread	with cover	79.5	HDC 10B SDLU 1M20G	1901570000
M 20	with thread		57	HDC 10B SLU 2M20G	1787660000
M 20	with thread	with cover	79.5	HDC 10B SDLU 2M20G	1787700000
M 25	with thread		57	HDC 10B SLU 1M25G	1901640000
M 25	with thread	with cover	96.5	HDC 24D SDLU 1M25G	1903410000
M 25	with thread		57	HDC 10B SLU 2M25G	1787650000
M 25	with thread	with cover	96.5	HDC 24D SDLU 2M25G	1787420000
M 32	with thread		74	HDC 24D SLU 1M32G	1903560000
M 32	with thread	with cover	96.5	HDC 24D SDLU 1M32G	1903510000
M 32	with thread		74	HDC 24D SLU 2M32G	1787370000
M 32	with thread	with cover	96.5	HDC 24D SDLU 2M32G	1787410000
PG 16	with thread		57	HDC 10B SLU 2PG16G	1655470000
PG 16	with thread	with cover	79.5	HDC 10B SDLU 2PG16G	1655680000

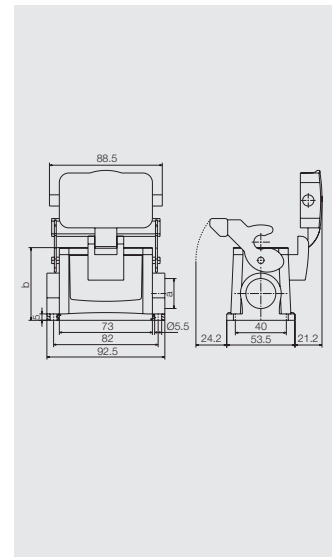

D

Coupling hood



a	Version	Cover	b (mm)	Designation	Order No.
M 20	with thread		55	HDC 10B KLU 1M20G	1787740000
M 25	with thread		55	HDC 10B KLU 1M25G	1787730000
M 25	with thread		75	HDC 24D KLU 1M25G	1787460000
M 32	with thread		75	HDC 24D KLU 1M32G	1787450000
PG 16	with thread		55	HDC 10B KLU 1PG16G	1655890000

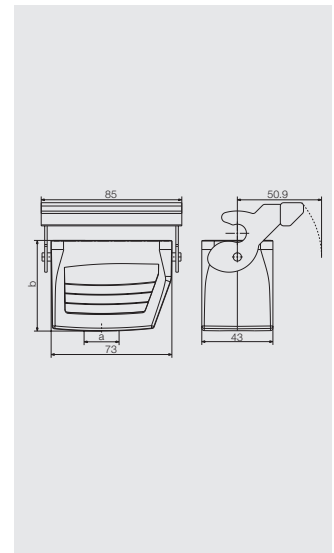

RockStar® Housings IP65 / NEMA 4X

Side locking, upper side

Size 4

Hood



Hood, Cable Entry sideways



a	Version	Cover	b (mm)	Designation	Order No.
M 25	with thread		52	HDC 10B TSBO 1M25G	1787570000
M 25	with thread		72	HDC 24D TSBO 1M25G	1787260000
M 32	with thread		72	HDC 24D TSBO 1M32G	1787250000
PG 16	with thread		52	HDC 10B TSBO 1PG16G	1654750000
PG 16	with thread		72	HDC 24D TSBO 1PG16G	1654810000
PG 21	with thread		72	HDC 24D TSBO 1PG21G	1654790000

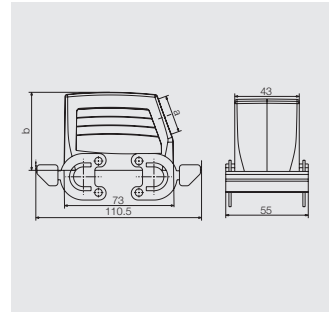

D

Hood, Cable Entry at top



a	Version	Cover	b (mm)	Designation	Order No.
M 25	with thread		52	HDC 10B TOBO 1M25G	1787610000
PG 16	with thread		52	HDC 10B TOBO 1PG16G	1654860000
PG 29	with thread		72	HDC 24D TOBO 1PG29G	1654920000

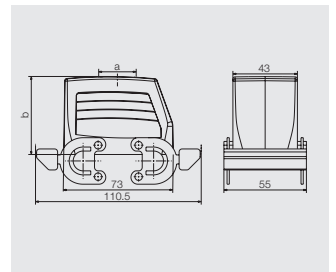

Cover



Version	Designation	Order No.
for hoods	HDC 10B DMDQ 4BO	1665250000

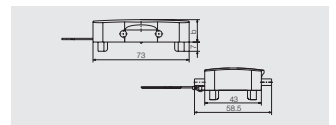

Base

Bulkhead housing



Version	Cover	b (mm)	Designation	Order No.
	with cover	51.6	HDC 10B ADBO	1205600000

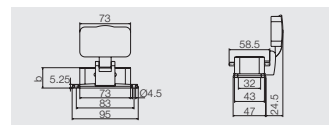

Base housing



a	Version	Cover	b (mm)	Designation	Order No.
M 20	with thread	with cover	79.5	HDC 10B SDBO 1M20G	1901490000
M 20	with thread	with cover	79.5	HDC 10B SDBO 2M20G	1787680000
M 25	with thread	with cover	79.5	HDC 10B SDBO 1M25G	1901510000
M 25	with thread	with cover	96.5	HDC 24D SDBO 1M25G	1903370000
M 25	with thread	with cover	79.5	HDC 10B SDBO 2M25G	1787670000
M 25	with thread	with cover	96.5	HDC 24D SDBO 2M25G	1787400000
PG 16	with thread	with cover	79.5	HDC 10B SDBO 2PG16G	1655000000

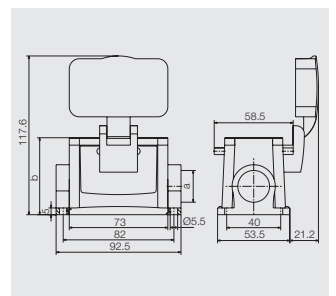

Size 4**End locking clamp on housing bottom**

The plug and play solution for your motor. With short assembly times and free choice of connection technology, this is Weidmüller's low-cost solution for heavy-duty connectors.

The HDC HB 10 AWVL angled housing replaces the motor terminal box. The housing can be mounted in four different ways (offset by 90°) thanks to fixing dimensions of 68 x 68 mm.

Suitable for use with standard inserts of the HE-10 series (screw, tension clamp or push-in technology) or inserts from the modular ConCept system.

HDC HB 10 AWVL**Ordering data**

Type	Qty	Order No.
HDC HB 10 AWVL	1	1790040000

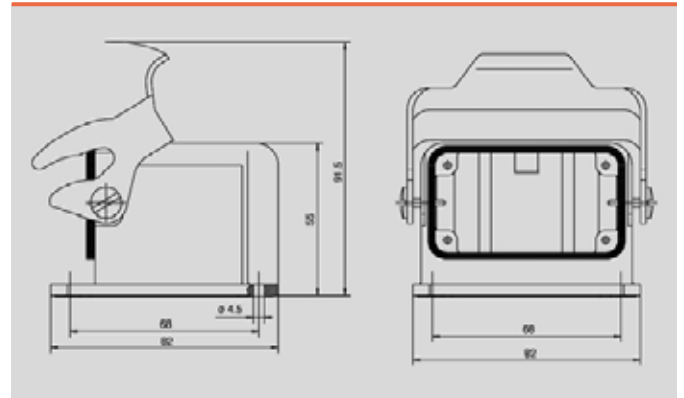
Dimensions

RockStar® Housings IP65 / NEMA 4X

End locking, lower side

Size 5

Hood



Hood, Cable Entry sideways



a	Version	Cover	b (mm)	Designation	Order No.
M 20	with thread		72	HDC 25A TSLU 1M20G	1788680000
M 25	with thread		58	HDC 16A TSLU 1M25G	1788740000
M 25	with thread		72	HDC 25A TSLU 1M25G	1788690000
PG 16	with thread		58	HDC 16A TSLU 1PG16G	1664690000
PG 16	with thread		72	HDC 25A TSLU 1PG16G	1664730000
PG 21	with thread		72	HDC 25A TSLU 1PG21G	1664750000

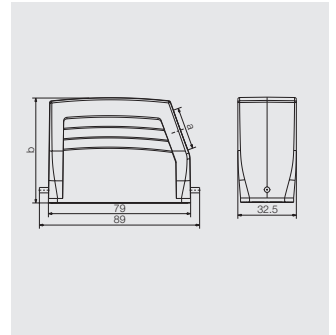

D

Hood, Cable Entry at top



a	Version	Cover	b (mm)	Designation	Order No.
M 20	with thread		72	HDC 25A TOLU 1M20G	1788710000
M 25	with thread		58	HDC 16A TOLU 1M25G	1788750000
M 25	with thread		72	HDC 25A TOLU 1M25G	1788700000
PG 16	with thread		58	HDC 16A TOLU 1PG16G	1664810000
PG 21	with thread		72	HDC 25A TOLU 1PG21G	1664870000

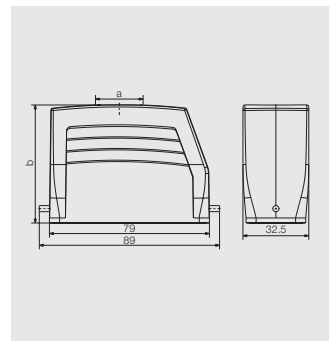

Cover



Version	Designation	Order No.
for hoods	HDC 16A DODL 1LB	1665900000

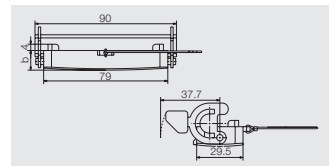

End locking, lower side

Size 5



Base

Bulkhead housing



Version	Cover	b (mm)	Designation	Order No.
	with cover	44.5	HDC 16A ADLU	1664940000
		25	HDC 16A ALU	1664920000

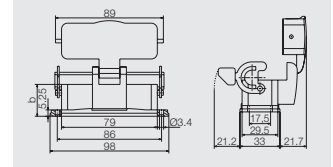

Base housing



a	Version	Cover	b (mm)	Designation	Order No.
M 20	with thread		57	HDC 16A SLU 2M20G	1788770000
M 20	with thread	with cover	76.5	HDC 16A SDLU 2M20G	1788790000
M 25	with thread		57	HDC 16A SLU 2M25G	1788760000
M 25	with thread	with cover	76.5	HDC 16A SDLU 2M25G	1788780000
PG 16	with thread		57	HDC 16A SLU 2PG16G	1665070000
PG 16	with cable gl.	with cover	76.5	HDC 16A SDLU 2PG17	1665300000
PG 21	with thread		57	HDC 16A SLU 1PG21G	1665090000

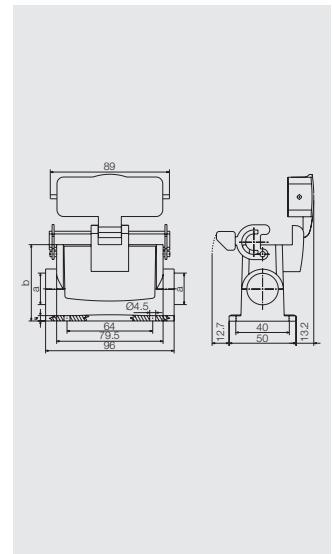

Coupling hood



a	Version	Cover	b (mm)	Designation	Order No.
M 25	with thread		53	HDC 16A KLU 1M25G	1788800000
PG 16	with thread		53	HDC 16A KLU 1PG16G	1665450000

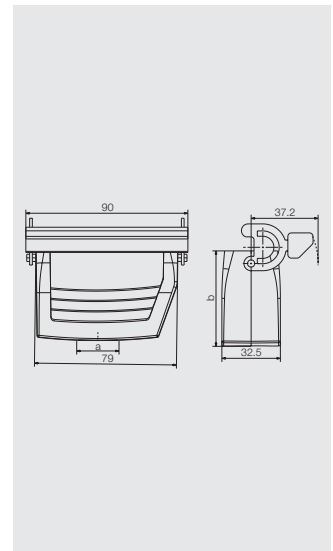

Cover



Version	Designation	Order No.
for bases	HDC 16A DMDL 2BO	1665910000

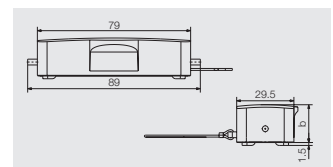

RockStar® Housings IP65 / NEMA 4X

Side locking, lower side

Size 6

Hood



Hood, Cable Entry sideways



a	Version	Cover	b (mm)	Designation	Order No.
M 25	with thread	61	HDC 16B TSBU 1M25G	1788180000	
M 25	with thread	76	HDC 40D TSBU 1M25G	1787010000	
M 32	with thread	76	HDC 40D TSBU 1M32G	1787000000	
M 40	with thread	60	HDC HB16 TSVU 1xM40G	1809620000	
PG 21	with thread	61	HDC 16B TSBU 1PG21G	1656480000	
PG 21	with thread	76	HDC 40D TSBU 1PG21G	1656520000	
PG 29	with thread	76	HDC 40D TSBU 1PG29G	1656540000	

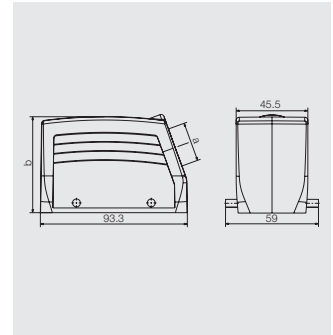

D

Hood, Cable Entry at top



a	Version	Cover	b (mm)	Designation	Order No.
M 25	with thread	61	HDC 16B TOBU 1M25G	1788210000	
M 25	with thread	76	HDC 40D TOBU 1M25G	1787070000	
M 32	with thread	76	HDC 40D TOBU 1M32G	1787060000	
PG 21	with thread	61	HDC 16B TOBU 1PG21G	1656590000	
PG 21	with thread	76	HDC 40D TOBU 1PG21G	1656630000	
PG 29	with thread	76	HDC 40D TOBU 1PG29G	1656650000	

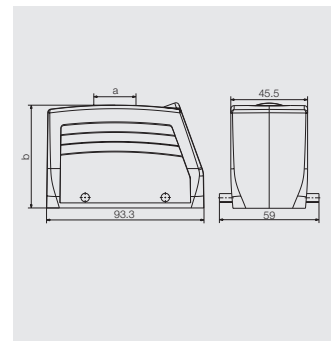

Cover



Version	Designation	Order No.
for hoods	HDC 16B DMDQ 2QB	1665270000

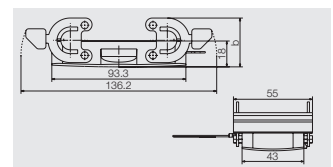

Side locking, lower side

Size 6



Base

Bulkhead housing



Version	Cover	b (mm)	Designation	Order No.
		29	HDC 16B ABU	1208600000

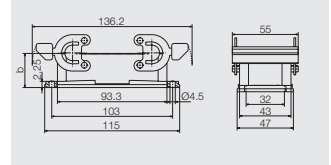

Base housing



a	Version	Cover	b (mm)	Designation	Order No.
M 25	with thread		64	HDC 16B SBU 1M25G	1899980000
M 25	with thread		84	HDC 40D SBU 1M25G	1902970000
M 25	with thread		64	HDC 16B SBU 2M25G	1788240000
M 25	with thread		84	HDC 40D SBU 2M25G	1787120000
M 32	with thread		84	HDC 40D SBU 1M32G	1902990000
M 32	with thread		84	HDC 40D SBU 2M32G	1787110000
PG 21	with thread		64	HDC 16B SBU 1PG21G	1656720000
PG 21	with thread		64	HDC 16B SBU 2PG21G	1656730000
PG 21	with thread		84	HDC 40D SBU 2PG21G	1656810000
PG 29	with thread		84	HDC 40D SBU 1PG29G	1656830000
PG 29	with thread		84	HDC 40D SBU 2PG29G	1656840000

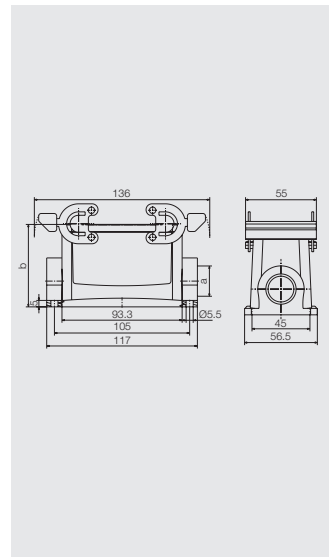

Coupling hood



a	Version	Cover	b (mm)	Designation	Order No.
M 25	with thread		79	HDC 40D KBU 1M25G	1787200000
M 32	with thread		79	HDC 40D KBU 1M32G	1787190000
PG 21	with thread		64	HDC 16B KBU 1PG21G	1657270000
PG 21	with thread		79	HDC 40D KBU 1PG21G	1657310000

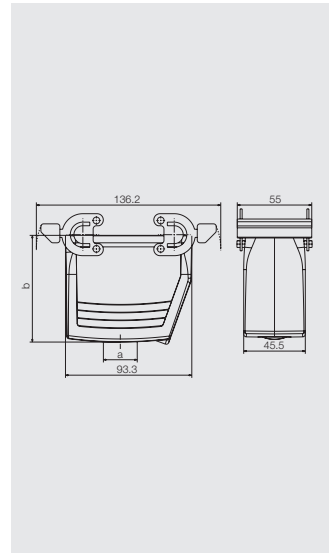

Cover



Version	Designation	Order No.
for bases	HDC 16B DODQ 4B0	1665260000

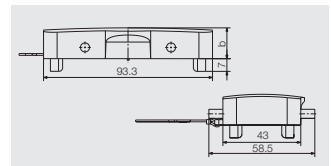

RockStar® Housings IP65 / NEMA 4X

End locking, lower side

Size 6

Hood



Hood, Cable Entry sideways



a	Version	Cover	b (mm)	Designation	Order No.
M 25	with thread	61	HDC 16B TSLU 1M25G	1788200000	
M 25	with thread	76	HDC 40D TSLU 1M25G	1787050000	
M 32	with thread	61	HDC 16B TSLU 1M32G	1804640000	
M 32	with thread	76	HDC 40D TSLU 1M32G	1787040000	
M 40	with thread	76	HDC 40D TSLU 1M40G	1804650000	
PG 21	with thread	61	HDC 16B TSLU 1PG21G	1657850000	
PG 21	with thread	76	HDC 40D TSLU 1PG21G	1657890000	
PG 29	with thread	76	HDC 40D TSLU 1PG29G	1657910000	

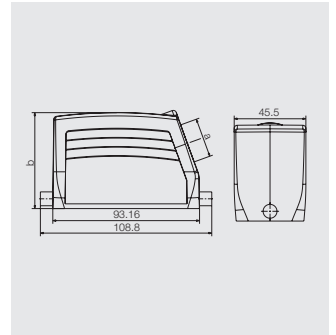

D

Hood, Cable Entry at top



a	Version	Cover	b (mm)	Designation	Order No.
M 25	with thread	61	HDC 16B TOLU 1M25G	1788230000	
M 32	with thread	61	HDC 16B TOLU 1M32G	1804630000	
M 32	with thread	76	HDC 40D TOLU 1M32G	1787100000	
PG 21	with thread	61	HDC 16B TOLU 1PG21G	1657960000	
PG 29	with thread	76	HDC 40D TOLU 1PG29G	1658020000	

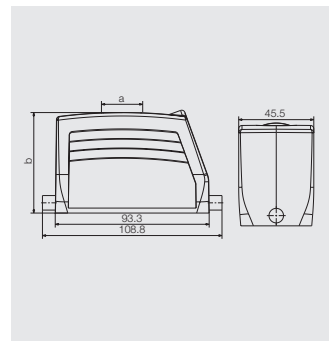

End locking, lower side

Size 6

Base



Bulkhead housing



Version	Cover	b (mm)	Designation	Order No.
	with cover	47	HDC 16B ADLU	1210100000
		29	HDC 16B ALU	1209700000

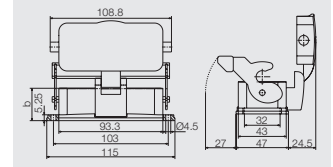

Base housing



a	Version	Cover	b (mm)	Designation	Order No.
M 25	with thread		64	HDC 16B SLU 1M25G	1900170000
M 25	with thread	with cover	102	HDC 40D SDLU 1M25G	1903070000
M 25	with thread		64	HDC 16B SLU 2M25G	1788250000
M 25	with thread	with cover	82	HDC 16B SDLU 2M25G	1788270000
M 25	with thread	with cover	102	HDC 40D SDLU 2M25G	1787180000
M 32	with thread		84	HDC 40D SLU 1M32G	1903110000
M 32	with thread	with cover	102	HDC 40D SDLU 1M32G	1903080000
M 32	with thread		84	HDC 40D SLU 2M32G	1804660000
M 32	with thread	with cover	102	HDC 40D SDLU 2M32G	1787170000
PG 21	with thread		64	HDC 16B SLU 1PG21G	1658110000
PG 21	with thread	with cover	82	HDC 16B SDLU 1PG21G	1658320000
PG 21	with thread		64	HDC 16B SLU 2PG21G	1658120000
PG 21	with thread	with cover	82	HDC 16B SDLU 2PG21G	1658330000
PG 29	with thread	with cover	102	HDC 40D SDLU 1PG29G	1658410000

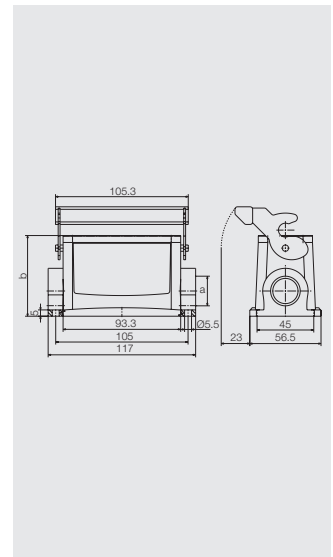

D

Coupling hood



a	Version	Cover	b (mm)	Designation	Order No.
M 25	with thread		64	HDC 16B KLU 1M25G	1788290000
M 25	with thread		79	HDC 40D KLU 1M25G	1787220000

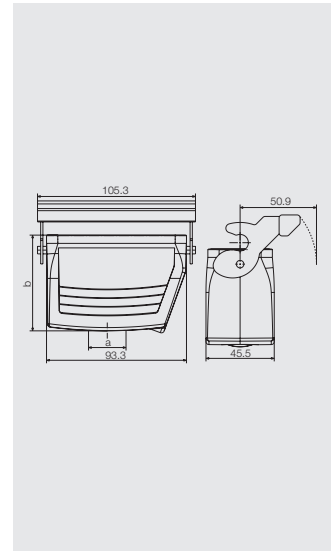

RockStar® Housings IP65 / NEMA 4X

Side locking, upper side

Size 6

Hood



Hood, Cable Entry sideways



a	Version	Cover	b (mm)	Designation	Order No.
M 25	with thread		61	HDC 16B TSBO 1M25G	1788190000
M 25	with thread		76	HDC 40D TSBO 1M25G	1787030000
M 32	with thread		76	HDC 40D TSBO 1M32G	1787020000
PG 21	with thread		61	HDC 16B TSBO 1PG21G	1657380000
PG 21	with thread		76	HDC 40D TSBO 1PG21G	1657420000

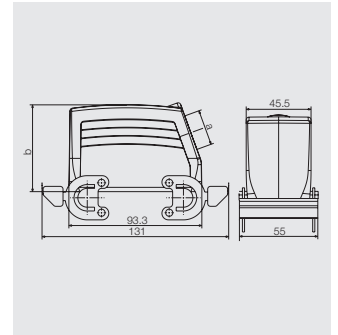

D

Hood, Cable Entry at top



a	Version	Cover	b (mm)	Designation	Order No.
M 25	with thread		61	HDC 16B TOBO 1M25G	1788220000
PG 21	with thread		61	HDC 16B TOBO 1PG21G	1657490000
PG 29	with thread		76	HDC 40D TOBO 1PG29G	1657550000

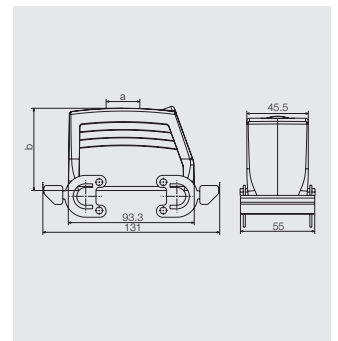

Cover



Version	Designation	Order No.
for hoods	HDC 16B DMDQ 4BO	1665620000

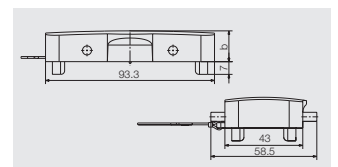

Side locking, upper side

Size 6

Base



Bulkhead housing



Version	Cover	b (mm)	Designation	Order No.
	with cover	47	HDC 16B ADBO	1209200000

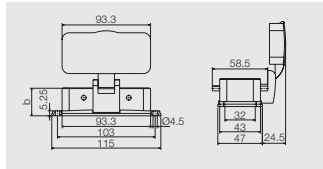

Base housing



a	Version	Cover	b (mm)	Designation	Order No.
M 25	with thread	with cover	82	HDC 16B SDBO 1M25G	1900080000
M 25	with thread	with cover	82	HDC 16B SDBO 2M25G	1788260000
PG 21	with thread	with cover	82	HDC 16B SDBO 2PG21G	1657640000

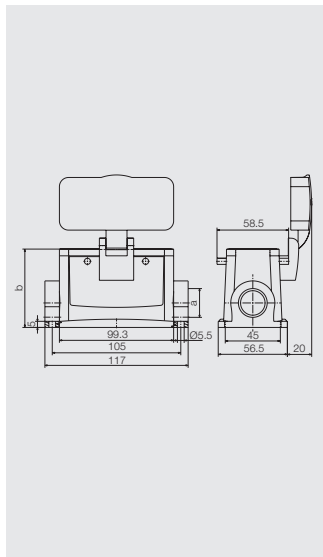

D

RockStar® Housings IP65 / NEMA 4X

Side locking, lower side

Size 7

Hood



Hood, Cable Entry sideways



a	Version	Cover	b (mm)	Designation	Order No.
M 25	with thread		75	HDC 32A TSBU 1M25G	1787960000
M 32	with thread		75	HDC 32A TSBU 1M32G	1787950000
PG 21	with thread		75	HDC 32A TSBU 1PG21G	1665670000
PG 29	with thread		75	HDC 32A TSBU 1PG29G	1665690000

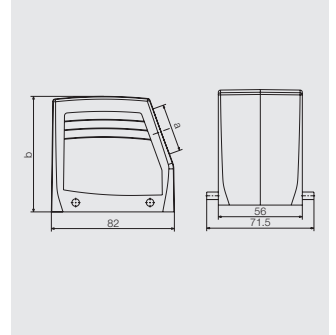

D

Hood, Cable Entry at top



a	Version	Cover	b (mm)	Designation	Order No.
M 32	with thread		75	HDC 32A TOBU 1M32G	1787990000
PG 21	with thread		75	HDC 32A TOBU 1PG21G	1665790000
PG 29	with thread		75	HDC 32A TOBU 1PG29G	1665810000

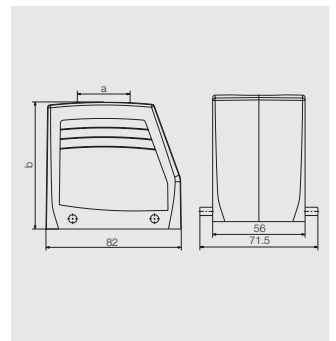

Side locking, lower side

Size 7

Base



Bulkhead housing



Version	Cover	b (mm)	Designation	Order No.
	25	75	HDC 32A ABU	1665860000

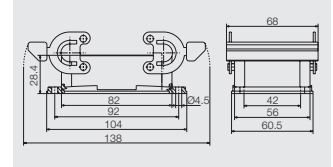

Base housing



a	Version	Cover	b (mm)	Designation	Order No.
M 25	with thread	75	75	HDC 32A SBU 1M25G	1903870000
M 25	with thread	75	75	HDC 32A SBU 2M25G	1788040000
PG 21	with thread	75	75	HDC 32A SBU 2PG21G	1665980000
PG 29	with thread	75	75	HDC 32A SBU 1PG29G	1666010000

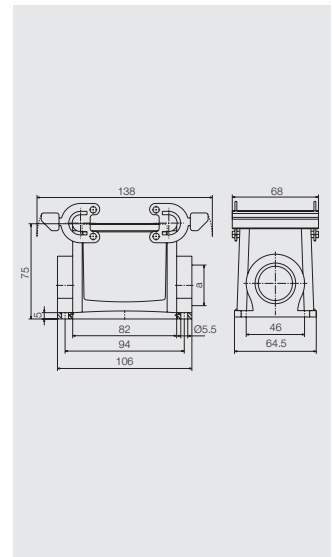

D

Coupling hood



a	Version	Cover	b (mm)	Designation	Order No.
M 25	with thread	76.5	76.5	HDC 32A KBU 1M25G	1788080000
M 32	with thread	76.5	76.5	HDC 32A KBU 1M32G	1788070000

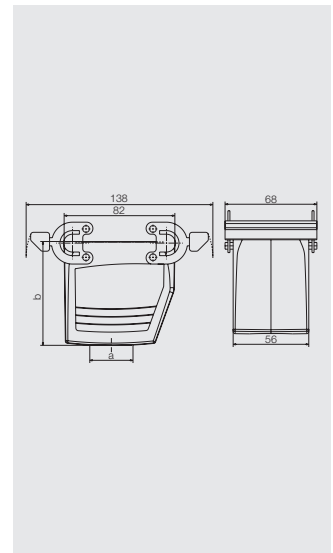

RockStar® Housings IP65 / NEMA 4X

Side locking, upper side

Size 7

Hood



Hood, Cable Entry sideways

a	Version	Cover	b (mm)	Designation	Order No.
M 25	with thread		75	HDC 32A TSBO 1M25G	1787980000
M 32	with thread		75	HDC 32A TSBO 1M32G	1787970000
PG 29	with thread		75	HDC 32A TSBO 1PG29G	1666270000

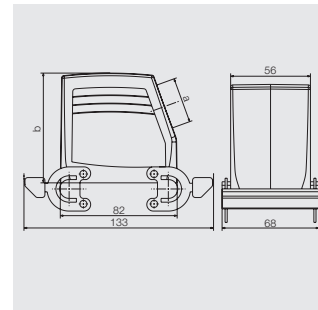

D

Hood, Cable Entry at top

a	Version	Cover	b (mm)	Designation	Order No.
M 32	with thread		77	HDC 32A TOBO 1M32G	1788010000

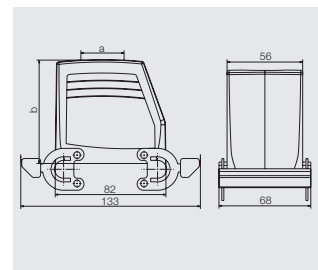

Cover

Version	Designation	Order No.
for hoods	HDC 32A DODQ 4BO	1665920000

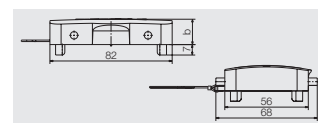

Base

Base housing

a	Version	Cover	b (mm)	Designation	Order No.
M 25	with thread	with cover	97	HDC 32A SDBO 1M25G	1903900000
M 25	with thread	with cover	97	HDC 32A SDBO 2M25G	1788060000
M 32	with thread	with cover	97	HDC 32A SDBO 1M32G	1903910000
M 32	with thread	with cover	97	HDC 32A SDBO 2M32G	1788050000
PG 21	with thread	with cover	97	HDC 32A SDBO 1PG21G	1666550000
PG 29	with thread	with cover	97	HDC 32A SDBO 1PG29G	1666590000

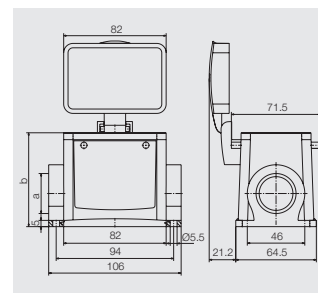

Cover

Version	Designation	Order No.
for bases	HDC 32A DMDQ 2QB	1665930000

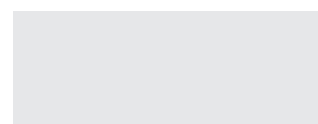

RockStar® Housings IP65 / NEMA 4X

Side locking, lower side

Size 8

Hood



Hood, Cable Entry sideways



a	Version	Cover	b (mm)	Designation	Order No.
M 25	with thread		61	HDC 24B TSBU 1M25G	1787760000
M 25	with thread		76	HDC 64D TSBU 1M25G	1786780000
M 32	with thread		61	HDC 24B TSBU 1M32G	1787750000
M 32	with thread		76	HDC 64D TSBU 1M32G	1786770000
M 40	with thread		61	HDC 24B TSBU 1M40G	1902480000
PG 21	with thread		61	HDC 24B TSBU 1PG21G	1661230000
PG 21	with thread		76	HDC 64D TSBU 1PG21G	1661300000
PG 29	with thread		61	HDC 24B TSBU 1PG29G	1661240000
PG 29	with thread		76	HDC 64D TSBU 1PG29G	1661320000

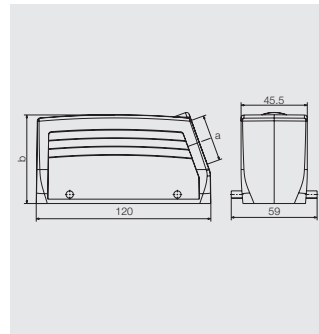

D

Hood, Cable Entry at top



a	Version	Cover	b (mm)	Designation	Order No.
M 25	with thread		61	HDC 24B TOBU 1M25G	1787820000
M 32	with thread		61	HDC 24B TOBU 1M32G	1787810000
M 32	with thread		76	HDC 64D TOBU 1M32G	1786830000
M 40	with thread		61	HDC 24B TOBU 1M40G	1902980000
PG 21	with thread		61	HDC 24B TOBU 1PG21G	1661370000
PG 21	with thread		76	HDC 64D TOBU 1PG21G	1661440000
PG 29	with thread		61	HDC 24B TOBU 1PG29G	1661380000
PG 29	with thread		76	HDC 64D TOBU 1PG29G	1661460000

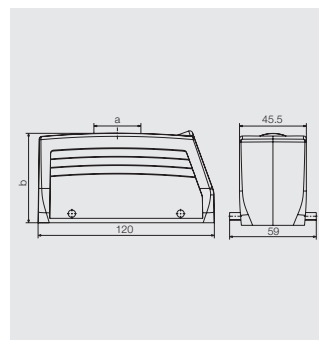

Cover



Version	Designation	Order No.
for hoods	HDC 24B DMDQ 2QB	1665640000

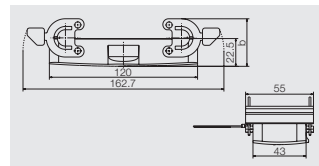

Side locking, lower side

Size 8



Base

Bulkhead housing



Version	Cover	b (mm)	Designation	Order No.
		29.3	HDC 24B ABU	1212400000

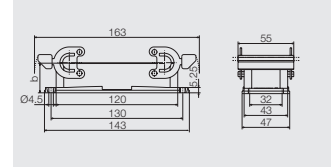

Base housing



a	Version	Cover	b (mm)	Designation	Order No.
M 25	with thread	64	HDC 24B SBU 1M25G	1901150000	
M 25	with thread	84	HDC 64D SBU 1M25G	1904340000	
M 25	with thread	64	HDC 24B SBU 2M25G	1787870000	
M 25	with thread	84	HDC 64D SBU 2M25G	1786890000	
M 32	with thread	84	HDC 64D SBU 1M32G	1904350000	
M 32	with thread	84	HDC 64D SBU 2M32G	1786880000	
PG 21	with thread	64	HDC 24B SBU 1PG21G	1661510000	
PG 21	with thread	64	HDC 24B SBU 2PG21G	1661520000	
PG 21	with thread	84	HDC 64D SBU 2PG21G	1661590000	
PG 29	with thread	84	HDC 64D SBU 2PG29G	1661630000	

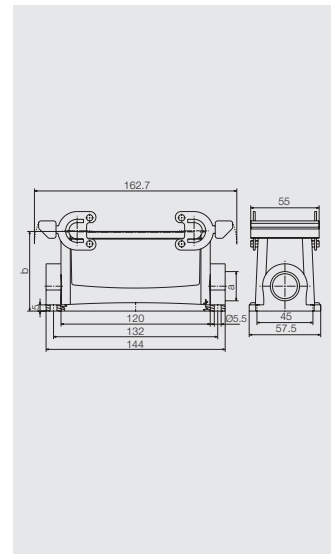

Coupling hood



a	Version	Cover	b (mm)	Designation	Order No.
M 25	with thread	65	HDC 24B KBU 1M25G	1787920000	
M 32	with thread	79	HDC 64D KBU 1M32G	1786960000	
PG 21	with thread	65	HDC 24B KBU 1PG21G	1661720000	
PG 29	with thread	65	HDC 24B KBU 1PG29G	1661730000	
PG 29	with thread	79	HDC 64D KBU 1PG29G	1661810000	

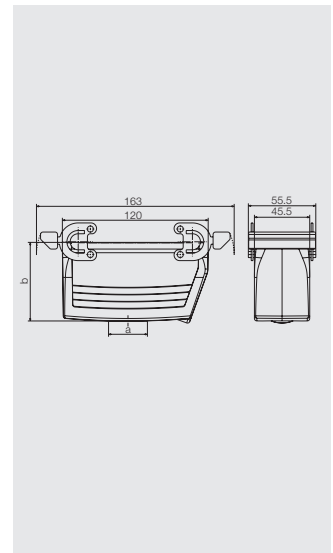

Cover



Version	Designation	Order No.
for bases	HDC 24B DODQ 4B0	1665630000

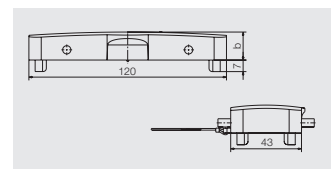

D

RockStar® Housings IP65 / NEMA 4X

End locking, lower side

Size 8

Hood



Hood, Cable Entry sideways



a	Version	Cover	b (mm)	Designation	Order No.
M 25	with thread		61	HDC 24B TSLU 1M25G	1787800000
M 32	with thread		61	HDC 24B TSLU 1M32G	1787790000
M 32	with thread		76	HDC 64D TSLU 1M32G	1786810000
M 40	with thread		76	HDC 64D TSLU 1M40G	1804610000
PG 21	with thread		61	HDC 24B TSLU 1PG21G	1662390000
PG 21	with thread		76	HDC 64D TSLU 1PG21G	1662470000
PG 29	with thread		61	HDC 24B TSLU 1PG29G	1662410000
PG 29	with thread		76	HDC 64D TSLU 1PG29G	1662490000

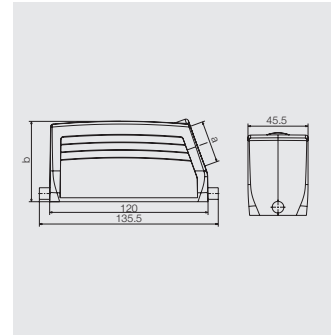

D

Hood, Cable Entry at top



a	Version	Cover	b (mm)	Designation	Order No.
M 25	with thread		61	HDC 24B TOLU 1M25G	1787860000
M 25	with thread		76	HDC 64D TOLU 1M25G	1786870000
M 32	with thread		61	HDC 24B TOLU 1M32G	1787850000
M 32	with thread		76	HDC 64D TOLU 1M32G	1786860000
PG 21	with thread		61	HDC 24B TOLU 1PG21G	1662540000
PG 21	with thread		76	HDC 64D TOLU 1PG21G	1662610000
PG 29	with thread		61	HDC 24B TOLU 1PG29G	1662550000
PG 29	with thread		76	HDC 64D TOLU 1PG29G	1662630000

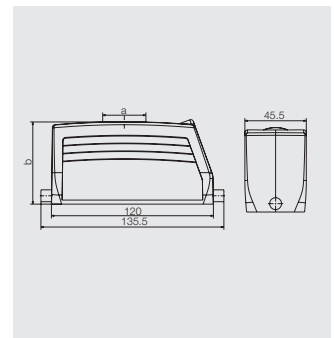

End locking, lower side

Size 8

Base



Bulkhead housing



Version	Cover	b (mm)	Designation	Order No.
	with cover	51.3	HDC 24B ADLU	1214300000
		29.3	HDC 24B ALU	1213900000

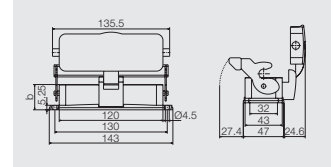

Base housing



a	Version	Cover	b (mm)	Designation	Order No.
M 25	with thread		64	HDC 24B SLU 1M25G	1901560000
M 25	with thread	with cover	86	HDC 24B SDLU 1M25G	1901480000
M 25	with thread		84	HDC 64D SLU 1M25G	1904480000
M 25	with thread	with cover	106	HDC 64D SDLU 1M25G	1904430000
M 25	with thread		64	HDC 24B SLU 2M25G	1787880000
M 25	with thread	with cover	86	HDC 24B SDLU 2M25G	1787900000
M 25	with thread		84	HDC 64D SLU 2M25G	1786910000
M 25	with thread	with cover	106	HDC 64D SDLU 2M25G	1786950000
M 32	with thread		84	HDC 64D SLU 1M32G	1904490000
M 32	with thread	with cover	106	HDC 64D SDLU 1M32G	1904440000
M 32	with thread		84	HDC 64D SLU 2M32G	1786900000
M 32	with thread	with cover	106	HDC 64D SDLU 2M32G	1786940000
PG 21	with thread		64	HDC 24B SLU 2PG21G	1662720000
PG 21	with thread	with cover	86	HDC 24B SDLU 2PG21G	1214500000
PG 29	with thread	with cover	106	HDC 64D SDLU 2PG29G	1663040000

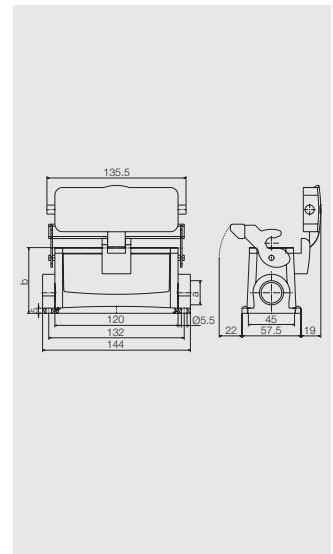

D

RockStar® Housings IP65 / NEMA 4X

Side locking, upper side

Size 8

Hood



Hood, Cable Entry sideways



a	Version	Cover	b (mm)	Designation	Order No.
M 25	with thread		61	HDC 24B TSBO 1M25G	1787780000
M 25	with thread		76	HDC 64D TSBO 1M25G	1786800000
M 32	with thread		61	HDC 24B TSBO 1M32G	1787770000
M 32	with thread		76	HDC 64D TSBO 1M32G	1786790000
PG 21	with thread		61	HDC 24B TSBO 1PG21G	1661860000
PG 21	with thread		76	HDC 64D TSBO 1PG21G	1661940000
PG 29	with thread		61	HDC 24B TSBO 1PG29G	1661880000
PG 29	with thread		76	HDC 64D TSBO 1PG29G	1661960000

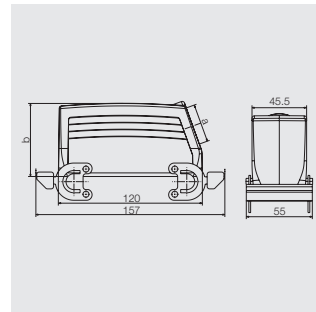

D

Hood, Cable Entry at top



a	Version	Cover	b (mm)	Designation	Order No.
M 32	with thread		61	HDC 24B TOBO 1M32G	1787830000
PG 21	with thread		76	HDC 64D TOBO 1PG21G	1662080000
PG 29	with thread		61	HDC 24B TOBO 1PG29G	1662020000
PG 29	with thread		76	HDC 64D TOBO 1PG29G	1662100000

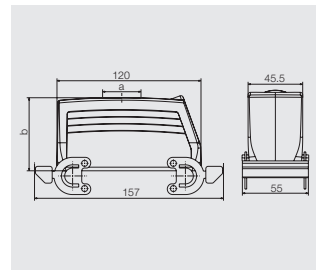

Cover



Version	Designation	Order No.
for hoods	HDC 24B DMDQ 4BO	1665650000

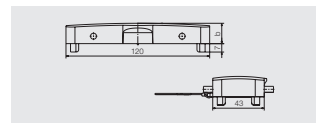

Base

Bulkhead housing



Version	Cover	b (mm)	Designation	Order No.
	with cover	51.3	HDC 24B ADBO	1213300000

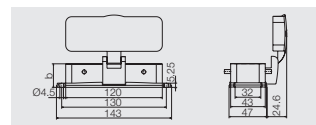

Base housing



a	Version	Cover	b (mm)	Designation	Order No.
M 32	with thread	with cover	106	HDC 64D SDBO 1M32G	1904400000
M 32	with thread	with cover	106	HDC 64D SDBO 2M32G	1786920000
PG 21	with thread	with cover	86	HDC 24B SDBO 2PG21G	1662180000
PG 29	with thread	with cover	106	HDC 64D SDBO 1PG29G	1662280000

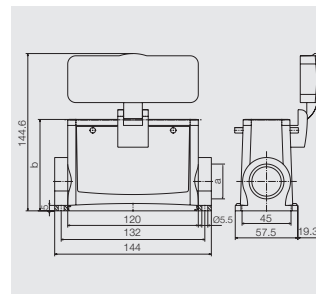

RockStar® Housings IP65 / NEMA 4X

End locking, lower side

Size 9

Hood



Hood, Cable Entry sideways



a	Version	Cover	b (mm)	Designation	Order No.
M 32	with thread		79	HDC 48A TSLU 1M32G	1788550000
PG 29	with thread		79	HDC 48A TSLU 1PG29G	1666710000

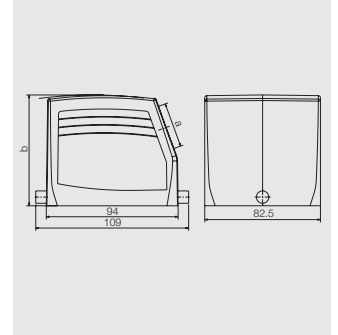

D

Hood, Cable Entry at top



a	Version	Cover	b (mm)	Designation	Order No.
M 32	with thread		79	HDC 48A TOLU 1M32G	1788560000
PG 29	with thread		79	HDC 48A TOLU 1PG29G	1666730000

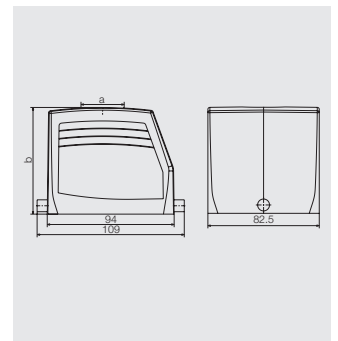

End locking, lower side

Size 9

Base



Bulkhead housing



Version	Cover	b (mm)	Designation	Order No.
	with cover	53	HDC 48A ADLU	1666750000
		36	HDC 48A ALU	1666740000

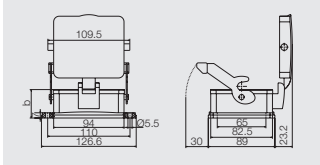

Base housing



a	Version	Cover	b (mm)	Designation	Order No.
M 32	with thread		79	HDC 48A SLU 2M32G	1788570000
PG 29	with thread		79	HDC 48A SLU 1PG29G	1666770000
PG 29	with thread	with cover	96	HDC 48A SDLU 1PG29G	1666810000

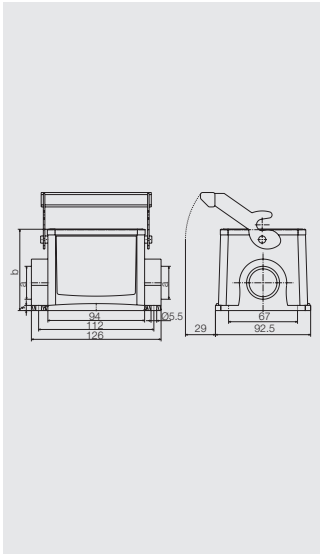

RockStar® Housings IP65 / NEMA 4X

Side locking, lower side

Size 10

Hood



Hood, Cable Entry sideways



a	Version	Cover	b (mm)	Designation	Order No.
M 32	with thread		79	HDC 32B TSBU 1M32G	1788400000
PG 29	with thread		79	HDC 32B TSBU 1PG29G	1666840000

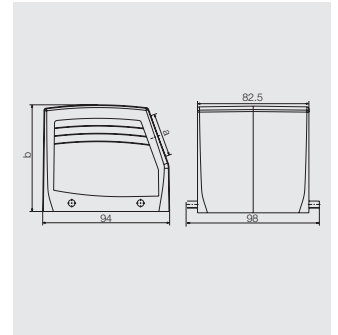

D

Hood, Cable Entry at top



a	Version	Cover	b (mm)	Designation	Order No.
M 32	with thread		79	HDC 32B TOBU 1M32G	1788430000
PG 29	with thread		79	HDC 32B TOBU 1PG29G	1666870000
PG 29	with cable gland		79	HDC 32B TOBU 1PG29V	1217300000

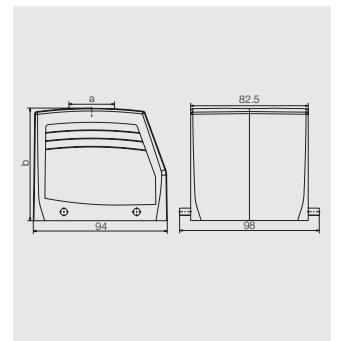

Side locking, lower side

Size 10

Base



Bulkhead housing



Version	Cover	b (mm)	Designation	Order No.
		38	HDC 32B ABU	1217800000

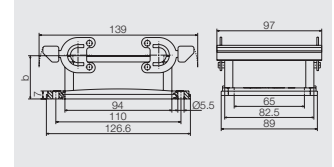

Base housing



a	Version	Cover	b (mm)	Designation	Order No.
M 32	with thread		79	HDC 32B SBU 1M32G	1902600000
M 32	with thread		79	HDC 32B SBU 2M32G	1788460000
PG 29	with thread		79	HDC 32B SBU 2PG29G	1666920000
PG 36	with thread		79	HDC 32B SBU 1PG36G	1902610000
PG 36	with thread		79	HDC 32B SBU 2PG36G	1902640000

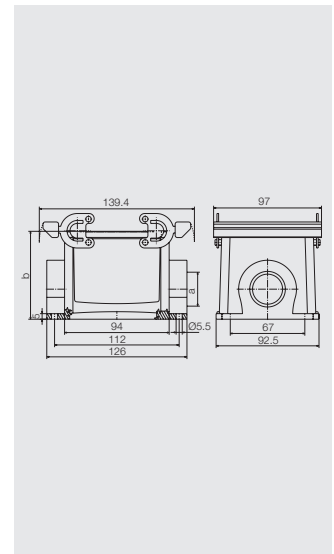

Coupling hood



a	Version	Cover	b (mm)	Designation	Order No.
M 40	with thread		83	HDC 32B KBU 1M40G	1902730000
PG 29	with thread		83	HDC 32B KBU 1PG29G	1902740000
PG 29	with thread		83	HDC 32B KBU 1PG36G	1902750000

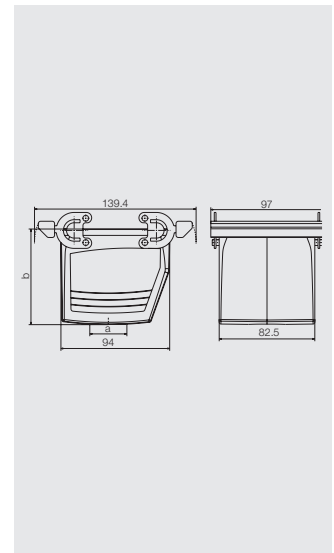

D

RockStar® Housings IP65 / NEMA 4X

End locking, lower side

Size 10

Hood



Hood, Cable Entry sideways



a	Version	Cover	b (mm)	Designation	Order No.
M 32	with thread		79	HDC 32B TSLU 1M32G	1788420000
PG 29	with thread		79	HDC 32B TSLU 1PG29G	1667120000
PG 29	with cable gland		79	HDC 32B TSLU 1PG29V	1219300000

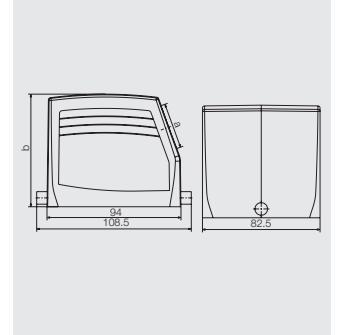

D

Hood, Cable Entry at top



a	Version	Cover	b (mm)	Designation	Order No.
M 32	with thread		79	HDC 32B TOLU 1M32G	1788450000

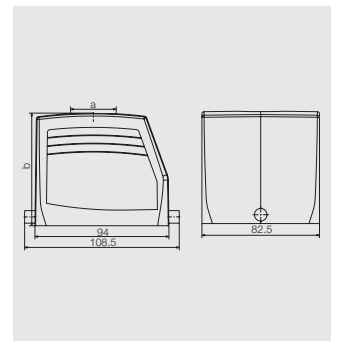

End locking, lower side

Size 10



Base

Bulkhead housing



Version	Cover	b (mm)	Designation	Order No.
	with cover	55	HDC 32B ADLU	1219800000
		38	HDC 32B ALU	1219500000

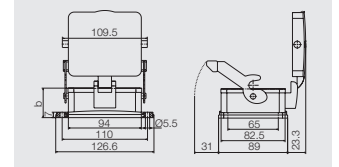

Base housing



a	Version	Cover	b (mm)	Designation	Order No.
M 32	with thread		79	HDC 32B SLU 1M32G	1902670000
M 32	with thread	with cover	96	HDC 32B SDLU 1M32G	1902650000
M 32	with thread		79	HDC 32B SLU 2M32G	1788470000
M 32	with thread	with cover	96	HDC 32B SDLU 2M32G	1788490000

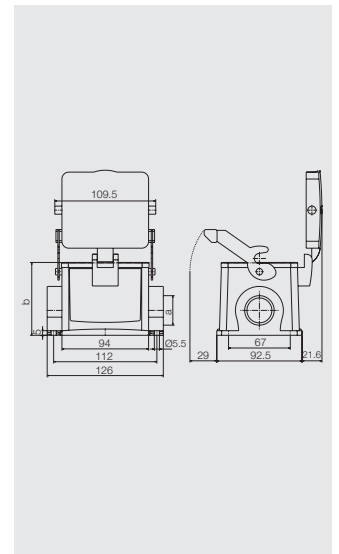

Coupling hood



a	Version	Cover	b (mm)	Designation	Order No.
M 32	with thread		83	HDC 32B KLU 1M32G	1788500000

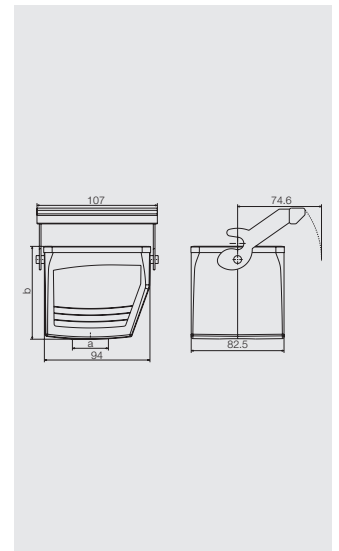

D

RockStar® Housings IP65 / NEMA 4X

Side locking, upper side

Size 10

Hood



Hood, Cable Entry sideways



a	Version	Cover	b (mm)	Designation	Order No.
M 32	with thread		79	HDC 32B TSBO 1M32G	1788410000

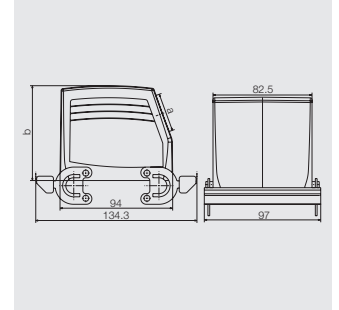

D

Base

Bulkhead housing



Version	Cover	b (mm)	Designation	Order No.
	with cover	55	HDC 32B ADBO	1218800000

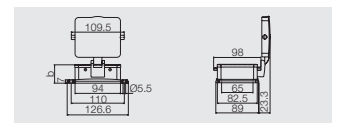

End locking, lower side

Size 12

Hood



Hood, Cable Entry sideways



a	Version	Cover	b (mm)	Designation	Order No.
M 32	with thread		94	HDC 48B TSLU 1M32G	1788320000
M 40	with thread		94	HDC 48B TSLU 1M40G	1788310000
M 50	with thread		94	HDC 48B TSLU 1M50G	1788300000
PG 29	with thread		94	HDC 48B TSLU 1PG29G	1650850000
PG 36	with thread		94	HDC 48B TSLU 1PG36G	1650860000
PG 42	with thread		94	HDC 48B TSLU 1PG42G	1670470000

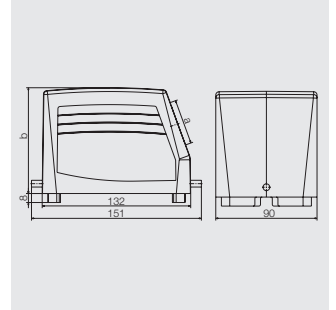

Hood, Cable Entry at top



a	Version	Cover	b (mm)	Designation	Order No.
M 32	with thread		94	HDC 48B TOLU 1M32G	1788350000
M 50	with thread		94	HDC 48B TOLU 1M50G	1788330000
PG 29	with thread		94	HDC 48B TOLU 1PG29G	1650980000
PG 36	with thread		94	HDC 48B TOLU 1PG36G	1651000000

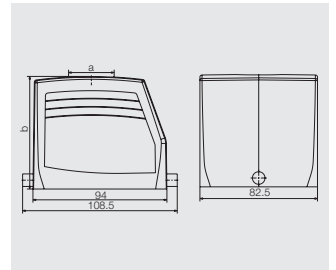

Base

Bulkhead housing



Version	Cover	b (mm)	Designation	Order No.
	with cover	62	HDC 48B ADLU	1222900000

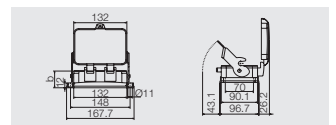

Base housing

a	Version	Cover	b (mm)	Designation	Order No.
M 32	with thread		100	HDC 48B SLU 1M32G	1904190000
M 32	with thread	with cover	120	HDC 48B SDLU 1M32G	1904150000
M 32	with thread		100	HDC 48B SLU 2M32G	1788370000
M 32	with thread	with cover	120	HDC 48B SDLU 2M32G	1788390000
M 40	with thread		100	HDC 48B SLU 2M40G	1788360000
PG 29	with thread		100	HDC 48B SLU 1PG29G	1651100000
PG 29	with thread	with cover	120	HDC 48B SDLU 1PG29G	1799810000
PG 29	with thread	with cover	120	HDC 48B SDLU 2PG29G	1667560000

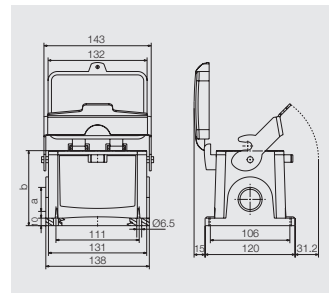

RockStar® Housing IP69K

RockStar® Housing IP69K	Overview	E.2
	RockStar® Housing IP69K impact resistant	E.4
	RockStar® Housing IP69K impact resistant XXL	E.10
	RockStar® Housing IP69K EMC	E.12
	RockStar® Housing IP69K EMC XXL	E.18

RockStar® Housing IP69K



The IP69K series of housings from Weidmüller are designed for demanding applications, specifically for tough mechanical conditions outdoors and for reliable immunity of electrical signals from interference.

Features:

- Housing of cast aluminium alloy
- Screw fastening
- Black powder coating
- Integrated surrounding metal collar on plug housing
- Seals on mounted housing: internal O-ring or circumferential flange seal

Typical applications:

- Rail engineering
- Underfloor installation on vehicles
- Shipbuilding

Various versions:

- different sizes
- different housing types
- different types of construction

Their advantages:

- multiple plugging and unplugging of electrical connections
- reliable assembly under time pressure
- corrosion protection
- IP68 / waterproof and dustproof to DIN EN 60529
- IP69K / waterproof for use in high-pressure cleaners to DIN 40050 – Part 9

RockStar® Housing IP69K impact resistant

Screw connection
Size 1



Hood

Hood, Cable Entry at top



a	Version	Designation	Order No.
M 20	with thread	HDC HA 3 IP68 TOS 1xM21	1827440000

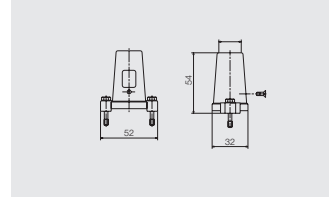

Base

Bulkhead housing



Version	Designation	Order No.
	HDC HA 3 IP68 AS M5	1827580000

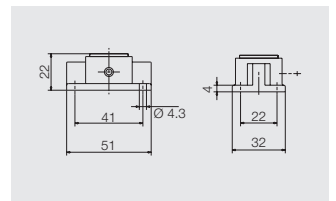

Base housing



a	Version	Designation	Order No.
M 20	with thread	HDC HA 3 IP68 SS 1xM21	1827680000

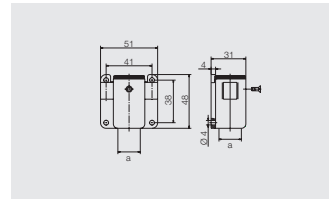

Cover



Version	Designation	Order No.
	HDC HA 3 IP68 EMVK MD	1826760000

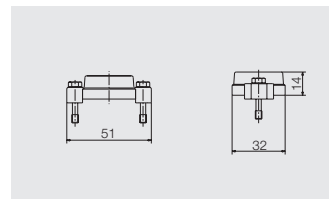

Screw connection
Size 3



Hood

Hood, Cable Entry sideways



a	Version	Designation	Order No.
M 25	with thread	HDC HB 6 IP68 TSS 1xM25	1827390000

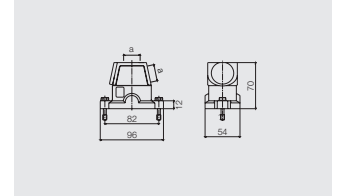

Hood, Cable Entry at top



a	Version	Designation	Order No.
M 25	with thread	HDC HB 6 IP68 TOS 1xM25	1827400000

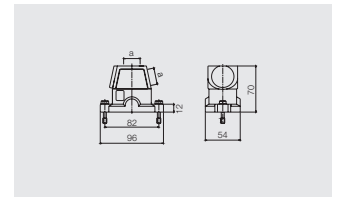

Base

Bulkhead housing



Version	Designation	Order No.
Seal inside	HDC HB 6 IP68 AS M4	1827560000

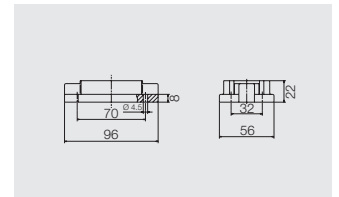

Bulkhead housing



Version	Designation	Order No.
Seal inside	HDC HB 6 IP68 AS M6	1828590000
flat gasket	HDC HB 6 IP68 AS M6.D	1828550000

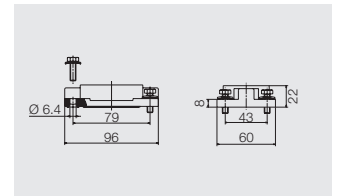

Base housing



a	Version	Designation	Order No.
M 25	with thread	HDC HB 6 IP68 SS 2xM25	1827660000

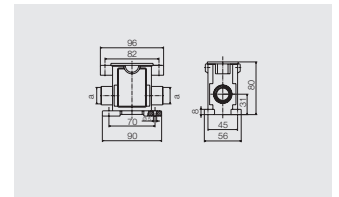

Cover



Version	Designation	Order No.
	HDC HB 6 IP68 EMVK MD	1826750000

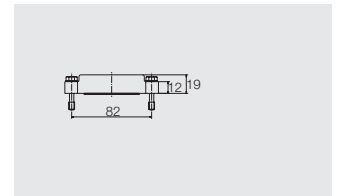

RockStar® Housing IP69K impact resistant

Screw connection Size 4



Hood

Hood, Cable Entry sideways



a	Version	Designation	Order No.
M 32	with thread	HDC HB 10 IP68 TSS 1xM33	1827350000

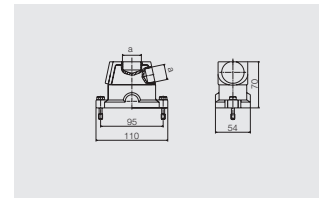

Hood, Cable Entry at top



a	Version	Designation	Order No.
M 32	with thread	HDC HB 10 IP68 TOS 1xM33	1827360000

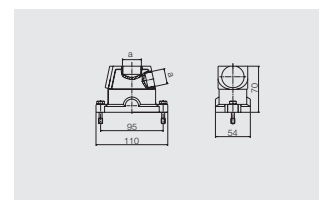

Base

Bulkhead housing



Version	Designation	Order No.
Seal inside	HDC HB 10 IP68 AS M4	1827540000

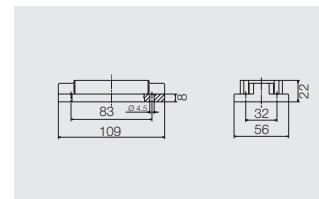

Bulkhead housing



Version	Designation	Order No.
flat gasket	HDC HB 10 IP68 AS M6.D	1828530000
Seal inside	HDC HB 10 IP68 AS M6	1828580000

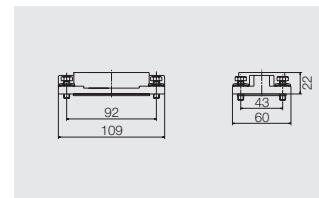

Base housing



a	Version	Designation	Order No.
M 32	with thread	HDC HB 10 IP68 SS 2xM33	1827640000

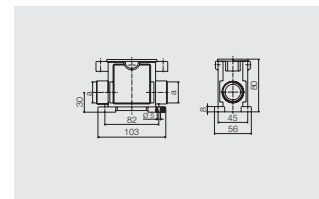

Cover



Version	Designation	Order No.
	HDC HB 10 IP68 EMVK MD	1826740000

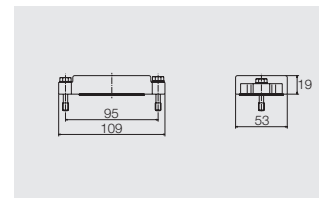

Screw connection
Size 6



Hood

Hood, Cable Entry sideways



a	Version	Designation	Order No.
M 32	with thread	HDC HB 16 IP68 TSS 1xM33	1827290000

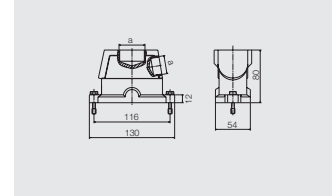

Hood, Cable Entry at top



a	Version	Designation	Order No.
M 32	with thread	HDC HB 16 IP68 TOS 1xM33	1827310000

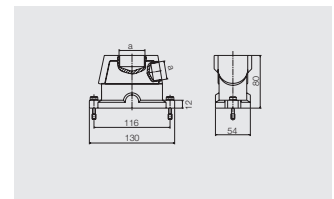

Base

Bulkhead housing



Version	Designation	Order No.
Seal inside	HDC HB 16 IP68 AS M4	1827520000

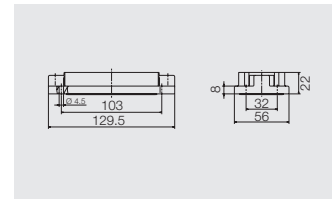

Bulkhead housing



Version	Designation	Order No.
flat gasket	HDC HB 16 IP68 AS M6 D	1828510000
Seal inside	HDC HB 16 IP68 AS M6	1828570000

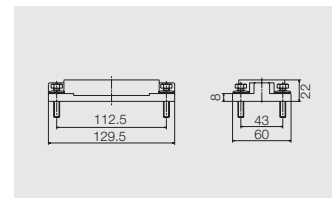

Base housing



a	Version	Designation	Order No.
M 32	with thread	HDC HB 16 IP68 SS 2xM33	1827620000

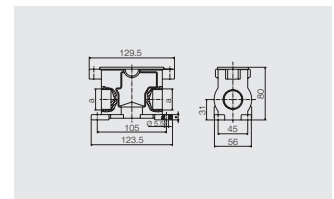

Cover



Version	Designation	Order No.
	HDC HB 16 IP68 EMVK MD	1826730000

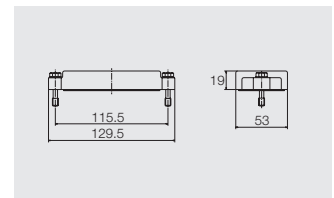

RockStar® Housing IP69K impact resistant

Screw connection Size 8



Hood

Hood, Cable Entry sideways



a	Version	Designation	Order No.
M 40	with thread	HDC HB 24 IP68 TSS 1xM41	1827240000

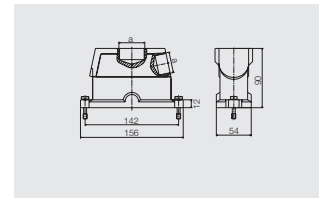

Hood, Cable Entry at top



a	Version	Designation	Order No.
M 40	with thread	HDC HB 24 IP68 TOS 1xM41	1827250000

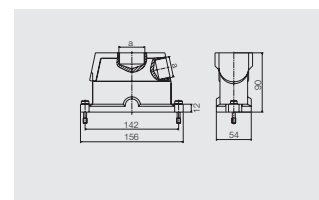

Base

Bulkhead housing



Version	Designation	Order No.
Seal inside	HDC HB 24 IP68 AS M4	1827500000

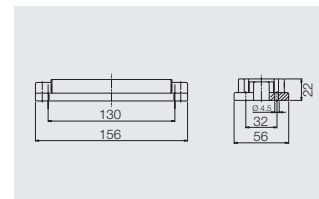

Bulkhead housing



Version	Designation	Order No.
flat gasket	HDC HB 24 IP68 AS M6 D	1828490000
Seal inside	HDC HB 24 IP68 AS M6	1828560000

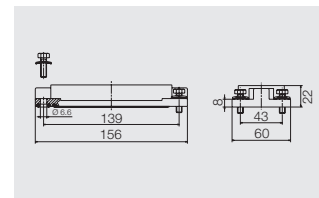

Base housing



a	Version	Designation	Order No.
M 40	with thread	HDC HB 24 IP68 SS 2xM41	1827600000

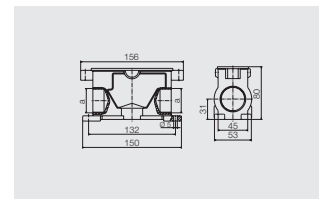

Cover



Version	Designation	Order No.
	HDC HB 24 IP68 EMVK MD	1826720000

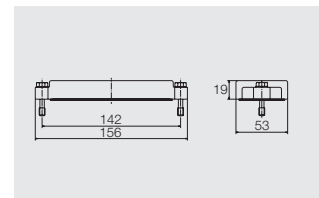

RockStar® Housing IP69K impact resistant XXL

Screw connection Size 8



Hood

Hood, Cable Entry sideways



a	Version	Designation	Order No.
M 50	with thread	HDC HB 24 TIP TSS 1xM50G	1827190000

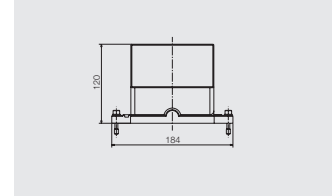

Hood, Cable Entry at top



a	Version	Designation	Order No.
M 50	with thread	HDC HB 24 TIP TOS 1xM50G	1827200000

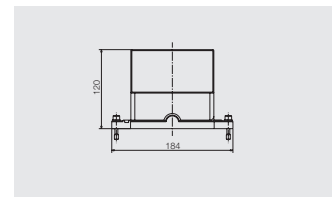

Base

Bulkhead housing



Version	Designation	Order No.
Seal inside, high	HDC HB 24 TIP AS M4	1846020000
Seal inside, standard	HDC HB 24 TIP AS M4	1827480000

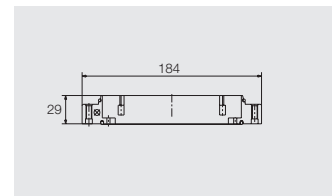

Screw connection
Size 12



Hood

Hood, Cable Entry sideways



a	Version	Designation	Order No.
M 40	with thread	HDC HB 48 TIP TSS 1xM40G	1827140000

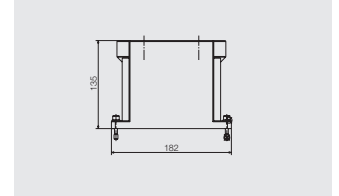

Hood, Cable Entry at top



a	Version	Designation	Order No.
M 50	with thread	HDC HB 48 TIP TOS 1xM50G	1827150000

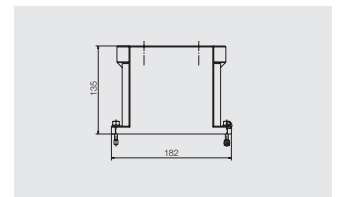

Hood, Cable Entry at front



	Version	Designation	Order No.
	with thread	HDC HB 48 TIP TVS 1xM50G	1853300000

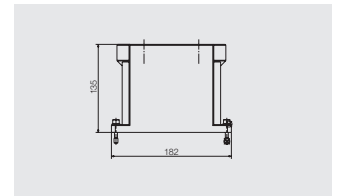

Base

Bulkhead housing



	Version	Designation	Order No.
	Seal inside, high	HDC HB 48 TIP AS M4	1846000000
	Seal inside, standard	HDC HB 48 TIP AS M4	1827460000

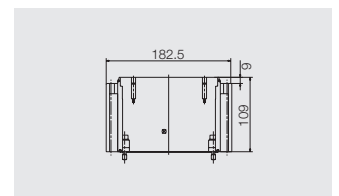

RockStar® Housing IP69K EMC

Screw connection Size 1



Hood

Hood, Cable Entry at top



a	Version	Designation	Order No.
M 20	with thread	HDC HA 3 EMVK TOS 1xM21	1827420000

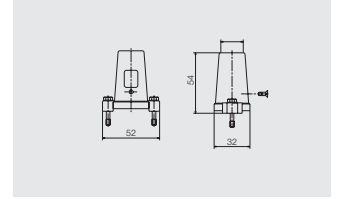

Base

Bulkhead housing



Version	Designation	Order No.
	HDC HA 3 EMVK AS M5	1827570000

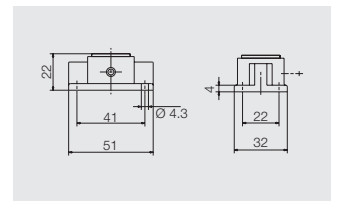

Base housing



a	Version	Designation	Order No.
M 20	with thread	HDC HA 3 EMVK SS 1xM21	1827670000

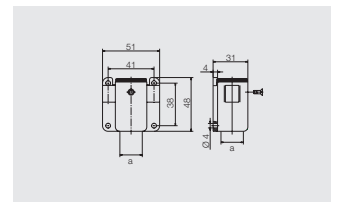

Cover



Version	Designation	Order No.
	HDC HA 3 IP68 EMVK MD	1826760000

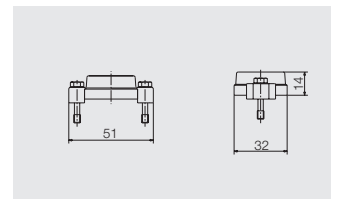

Screw connection
Size 3



Hood

Hood, Cable Entry sideways



a	Version	Designation	Order No.
M 25	with thread	HDC HB 6 EMVK TSS 1xM25	1827370000

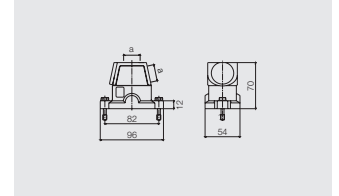

Hood, Cable Entry at top



a	Version	Designation	Order No.
M 25	with thread	HDC HB 6 EMVK TOS 1xM26	1827380000

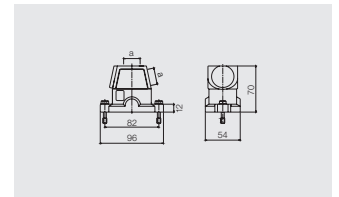

Base

Bulkhead housing



Version	Designation	Order No.
Seal inside	HDC HB 6 EMVK AS M4	1827550000

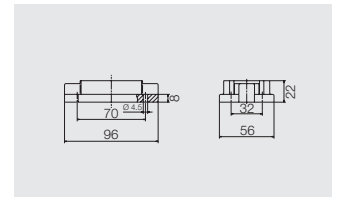

Bulkhead housing



Version	Designation	Order No.
flat gasket	HDC HB 6 EMVK AS M6	1828540000

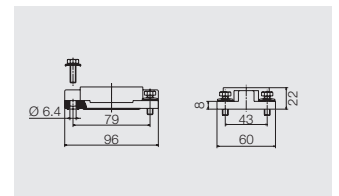

Base housing



a	Version	Designation	Order No.
M 25	with thread	HDC HB 6 EMVK SS 2xM26	1827650000

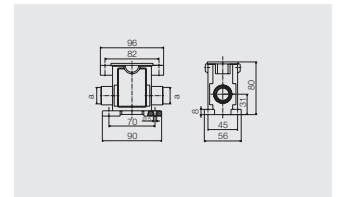

Cover



Version	Designation	Order No.
	HDC HB 6 IP68 EMVK MD	1826750000

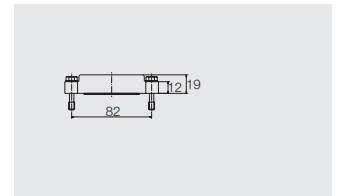

RockStar® Housing IP69K EMC

Screw connection
Size 4



Hood

Hood, Cable Entry sideways



a	Version	Designation	Order No.
M 32	with thread	HDC HB 10 EMVK TSS 1xM33	1827330000

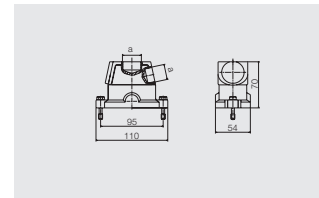

Hood, Cable Entry at top



a	Version	Designation	Order No.
M 32	with thread	HDC HB 10 EMVK TOS 1xM33	1827340000

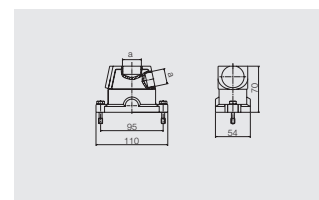

Base

Bulkhead housing



Version	Designation	Order No.
Seal inside	HDC HB 10 EMVK AS M4	1827530000

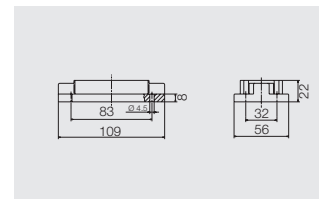

Bulkhead housing



Version	Designation	Order No.
Seal inside	HDC HB 10 EMVK AS M6	1828520000

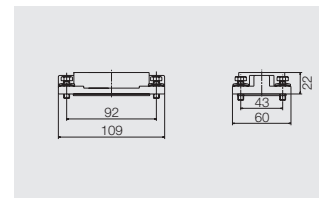

Base housing



a	Version	Designation	Order No.
M 32	with thread	HDC HB 10 EMVK SS 2xM33	1827630000

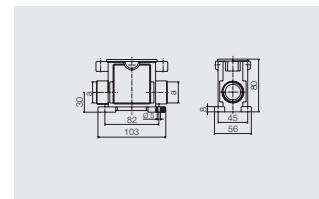

Cover



Version	Designation	Order No.
	HDC HB 10 IP68 EMVK MD	1826740000

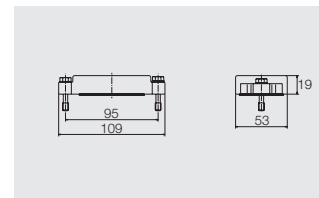

Screw connection
Size 6



Hood

Hood, Cable Entry sideways



a	Version	Designation	Order No.
M 32	with thread	HDC HB 16 EMVK TSS 1xM33	1827260000

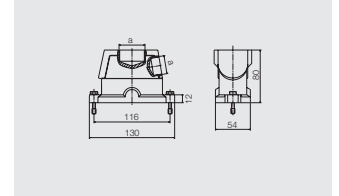

Hood, Cable Entry at top



a	Version	Designation	Order No.
M 32	with thread	HDC HB 16 EMVK TOS 1xM33	1827280000

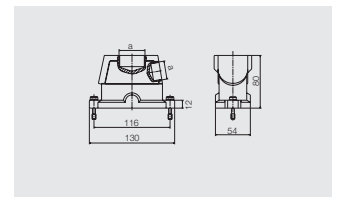

Base

Bulkhead housing



Version	Designation	Order No.
Seal inside	HDC HB 16 EMVK AS M4	1827510000

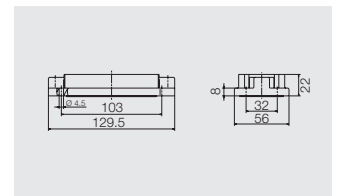

Bulkhead housing



Version	Designation	Order No.
Seal inside	HDC HB 16 EMVK AS M6	1828500000

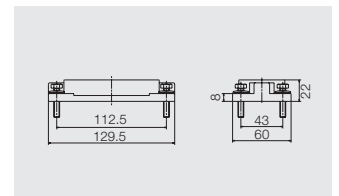

Base housing



a	Version	Designation	Order No.
M 32	with thread	HDC HB 16 EMVK SS 2xM33	1827610000

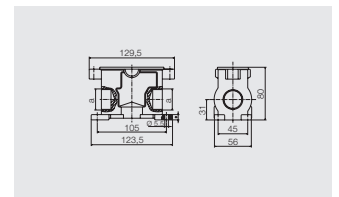

Cover



Version	Designation	Order No.
	HDC HB 16 IP68 EMVK MD	1826730000

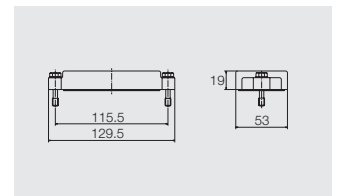

RockStar® Housing IP69K EMC

Screw connection Size 8



Hood

Hood, Cable Entry sideways



a	Version	Designation	Order No.
M 40	with thread	HDC HB 24 EMVK TSS 1xM41	1827220000

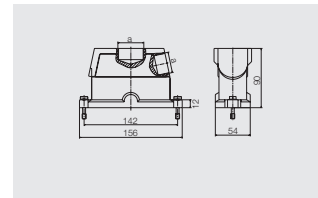

Hood, Cable Entry at top



a	Version	Designation	Order No.
M 40	with thread	HDC HB 24 EMVK TOS 1xM40	1827210000

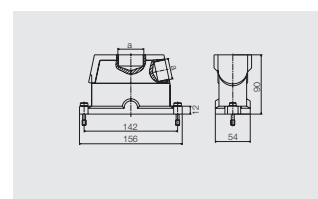

Base

Bulkhead housing



Version	Designation	Order No.
Seal inside	HDC HB 24 EMVK AS M4	1827490000

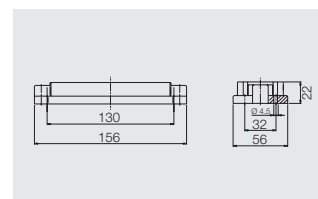

Bulkhead housing



Version	Designation	Order No.
flat gasket	HDC HB 24 EMVK AS M6	1828480000

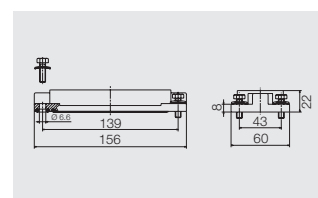

Base housing



a	Version	Designation	Order No.
M 40	with thread	HDC HB 24 EMVK SS 2xM41	1827590000

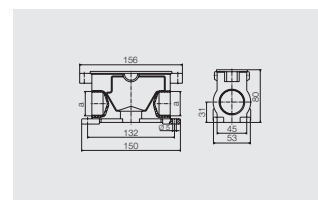

Cover



Version	Designation	Order No.
	HDC HB 24 IP68 EMVK MD	1826720000

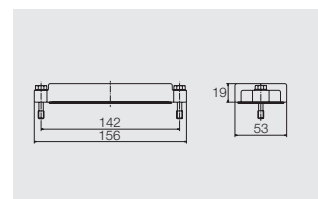

RockStar® Housing IP69K EMC XXL

**Screw connection
Size 8**



Hood

Hood, Cable Entry sideways



a	Version	Designation	Order No.
M 50	with thread	HDC HB 24 TEK TSS 1xM50G	1827160000

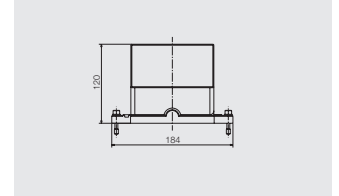

Hood, Cable Entry at top



a	Version	Designation	Order No.
M 50	with thread	HDC HB 24 TEK TOS 1xM50G	1827170000

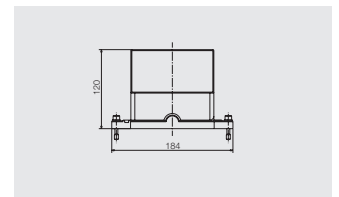

Base

Bulkhead housing



Version	Designation	Order No.
Seal inside, high	HDC HB 24 TEK AS M4	1846010000
Seal inside, standard	HDC HB 24 TEK AS M4	1827470000

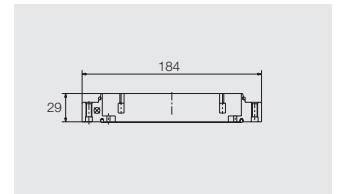

Screw connection
Size 12



Hood

Hood, Cable Entry sideways



a	Version	Designation	Order No.
M 40	with thread	HDC HB 48 TEK TSS 1xM40G	1827120000

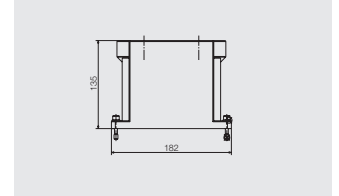

Hood, Cable Entry at top



a	Version	Designation	Order No.
M 50	with thread	HDC HB 48 TEK TOS 1xM50G	1827130000

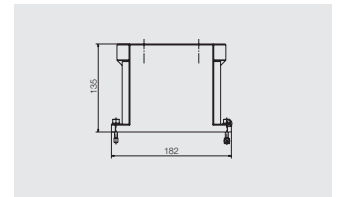

Hood, Cable Entry at front



	Version	Designation	Order No.
	with thread	HDC HB 48 TEK TVS 1xM50G	1853310000

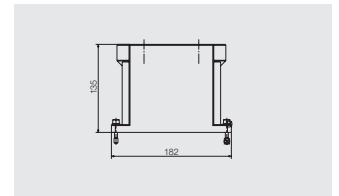

Base

Bulkhead housing



	Version	Designation	Order No.
	Seal inside, high	HDC HB 48 TEK AS M4	1845980000
	Seal inside, standard	HDC HB 48 TEK AS M4	1827450000

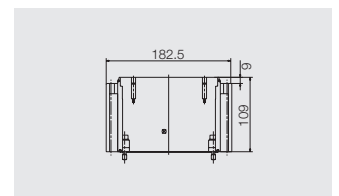

RockStar® kits

RockStar® kits	Overview	F.2
	Kits with HA inserts	F.4
	Kits with HE inserts	F.8
	Kits with HSB inserts	F.20

RockStar® kits



F

HDC kits are standardised sets of components for constructing a complete connector. They consist of:

- Male insert
- Female insert
- Connector housing
- Surface-mounted housing
- Cable gland

Weidmüller offers a range of popular connector combinations with metric or PG cable entry threads.

Their advantages:

- simple selection – all necessary components can be found on one page of the catalogue
- simple purchasing – only one part number for all individual parts together
- simple storage / logistics / picking – a complete set is combined in one pack; pick up a pack and everything you need's there and you avoid stocks of started quantities
- simple handling – all you have to carry with you is a pack with the complete set; no loose parts
- simple assembly – a 2.5 mm slotted screwdriver is all you need

Kits with HA inserts, 3 pole

250 V, 10 A

metric versions



Designation		Order No.
HDC-KIT-HA 03.30 M		1802470000
Component	Designation	Order No.
Female	HDC HA 3 FS	1498200000
Male	HDC HA 3 MS	1498100000
Bulkhead (Feed-Through)	HDC 04A ALU	1497600000
Hood	HDC 04A TOLU 1M20G	1788820000
Cable glands	VG M20 - MS 68	1772220000
Metal housing		

F



Designation		Order No.
HDC-KIT-HA 03.31 M		1802460000
Component	Designation	Order No.
Female	HDC HA 3 FS	1498200000
Male	HDC HA 3 MS	1498100000
Bulkhead (Feed-Through)	HDC 07A ALU	1652410000
Hood	HDC 07A TOLU 1M20G	1788520000
Cable glands	VG M20 - K 68	1772300000
Plastic housing		



Designation		Order No.
HDC-KIT-HA 03.32 M		1802450000
Component	Designation	Order No.
Female	HDC HA 3 FS	1498200000
Male	HDC HA 3 MS	1498100000
Bulkhead (Feed-Through)	HDC 04A AWLU	1497700000
Hood	HDC 04A TOLU 1M20G	1788820000
Cable glands	VG M20 - MS 68	1772220000
Metal housing		

250 V, 10 A



PG versions



Designation		Order No.
HDC-KIT-HA 03.30		1712560000
Component	Designation	Order No.
Female	HDC HA 3 FS	1498200000
Male	HDC HA 3 MS	1498100000
Bulkhead (Feed-Through)	HDC 04A ALU	1497600000
Hood	HDC-HA-3-TOVL1/11P	1498500000
Cable glands	VG 11-MS68	1569080000
Metal housing		



Designation		Order No.
HDC-KIT-HA 03.31		1712570000
Component	Designation	Order No.
Female	HDC HA 3 FS	1498200000
Male	HDC HA 3 MS	1498100000
Bulkhead (Feed-Through)	HDC 07A ALU	1652410000
Hood	HDC-HAD-7-TOVL1/11P	1652370000
Cable glands	VG 11-K68	1568990000
Plastic housing		



Designation		Order No.
HDC-KIT-HA 03.32		1712580000
Component	Designation	Order No.
Female	HDC HA 3 FS	1498200000
Male	HDC HA 3 MS	1498100000
Bulkhead (Feed-Through)	HDC 04A AWLU	1497700000
Hood	HDC-HA-3-TOVL1/11P	1498500000
Cable glands	VG 11-MS68	1569080000
Metal housing		



Designation		Order No.
HDC-KIT-HA 03.44		1712630000
Component	Designation	Order No.
Female	HDC HA 3 FS	1498200000
Male	HDC HA 3 MS	1498100000
Bulkhead (Feed-Through)	HDC 07A AWLU	1652420000
Hood	HDC-HAD-7-TOVL1/11P	1652370000
Cable glands	VG 11-K68	1568990000
Plastic housing		

Kits with HA inserts, 4 pole

250 V, 10 A



metric versions



Designation		Order No.
HDC-KIT-HA 04.40 M		1802440000
Component	Designation	Order No.
Female	HDC HA 4 FS	1498400000
Male	HDC HA 4 MS	1498300000
Bulkhead (Feed-Through)	HDC 04A ALU	1497600000
Hood	HDC 04A TOLU 1M20G	1788820000
Cable glands	VG M20 - MS 68	1772220000
Metal housing		

F



Designation		Order No.
HDC-KIT-HA 04.41 M		1802430000
Component	Designation	Order No.
Female	HDC HA 4 FS	1498400000
Male	HDC HA 4 MS	1498300000
Bulkhead (Feed-Through)	HDC 07A ALU	1652410000
Hood	HDC 07A TOLU 1M20G	1788520000
Cable glands	VG M20 - K 68	1772300000
Plastic housing		



Designation		Order No.
HDC Kit HA 04.42 M		1802700000
Component	Designation	Order No.
Female	HDC HA 4 FS	1498400000
Male	HDC HA 4 MS	1498300000
Bulkhead (Feed-Through)	HDC 04A AWLU	1497700000
Hood	HDC 04A TOLU 1M20G	1788820000
Cable glands	VG M20 - MS 68	1772220000
Metal housing		



Designation		Order No.
HDC Kit HA 04.46 M		1802720000
Component	Designation	Order No.
Female	HDC HA 4 FS	1498400000
Male	HDC HA 4 MS	1498300000
Bulkhead (Feed-Through)	HDC 07A AWLU	1652420000
Hood	HDC 07A TOLU 1M20G	1788520000
Cable glands	VG M20 - K 68	1772300000
Plastic housing		

250 V, 10 A



PG versions



Designation		Order No.
HDC-KIT-HA 04.40		1712590000
Component	Designation	Order No.
Female	HDC HA 4 FS	1498400000
Male	HDC HA 4 MS	1498300000
Bulkhead (Feed-Through)	HDC 04A ALU	1497600000
Hood	HDC-HA-3-TOVL1/11P	1498500000
Cable glands	VG 11-MS68	1569080000
Metal housing		



Designation		Order No.
HDC-KIT-HA 04.41		1712600000
Component	Designation	Order No.
Female	HDC HA 4 FS	1498400000
Male	HDC HA 4 MS	1498300000
Bulkhead (Feed-Through)	HDC 07A ALU	1652410000
Hood	HDC-HAD-7-TOVL1/11P	1652370000
Cable glands	VG 11-MS68	1569080000
Plastic housing		



Designation		Order No.
HDC-KIT-HA 04.42		1712610000
Component	Designation	Order No.
Female	HDC HA 4 FS	1498400000
Male	HDC HA 4 MS	1498300000
Bulkhead (Feed-Through)	HDC 04A AWLU	1497700000
Hood	HDC-HA-3-TOVL1/11P	1498500000
Cable glands	VG 11-MS68	1569080000
Metal housing		



Designation		Order No.
HDC-KIT-HA 04.46		1712650000
Component	Designation	Order No.
Female	HDC HA 4 FS	1498400000
Male	HDC HA 4 MS	1498300000
Bulkhead (Feed-Through)	HDC 07A AWLU	1652420000
Hood	HDC-HAD-7-TOVL1/11P	1652370000
Cable glands	VG 11-MS68	1569080000
Plastic housing		

Kits with HE inserts, 6 pole

500 V, 24 A

metric versions



Designation		Order No.
HDC Kit HE 06.10 M		1802730000
Component	Designation	Order No.
Female	HDC HE 6 FS	1200200000
Male	HDC HE 6 MS	1200000000
Bulkhead (Feed-Through)	HDC 06B ALU	1202100000
Hood	HDC 06B TSLU 1M20G	1788100000
Cable glands	VG M20 - MS 68	1772220000
Metal housing		

F



Designation		Order No.
HDC Kit HE 06.11 M		1802740000
Component	Designation	Order No.
Female	HDC HE 6 FS	1200200000
Male	HDC HE 6 MS	1200000000
Bulkhead (Feed-Through)	HDC 06B ALU	1202100000
Hood	HDC 06B TOLU 1M20G	1788120000
Cable glands	VG M20 - MS 68	1772220000
Metal housing		

500 V, 24 A (16 A)



PG versions



Designation		Order No.
HDC-KIT-HE 06.10		1712460000
Component	Designation	Order No.
Female	HDC HE 6 FS	1200200000
Male	HDC HE 6 MS	1200000000
Bulkhead (Feed-Through)	HDC 06B ALU	1202100000
Hood	HDC-HB-6-TSVL1/16P	1652510000
Cable glands	VG 16-MS68	1569100000
Metal housing		



Designation		Order No.
HDC-KIT-HE 06.11		1712660000
Component	Designation	Order No.
Female	HDC HE 6 FS	1200200000
Male	HDC HE 6 MS	1200000000
Bulkhead (Feed-Through)	HDC 06B ALU	1202100000
Hood	HDC-HB-6-TOVL1/16P	1652630000
Cable glands	VG 16-MS68	1569100000
Metal housing		



Designation		Order No.
HDC-KIT-HE 06.20		1712700000
Component	Designation	Order No.
Female	DSTV HE BL6 S	1848550000
Male	HDC HE 6 MS	1200000000
Bulkhead (Feed-Through)	HDC 06B ALU	1202100000
Hood	HDC-HB-6-TSVL1/16P	1652510000
Cable glands	VG 16-MS68	1569100000
Metal housing		

Kits with HE inserts, 10 pole

500 V, 16 A

metric versions



Designation		Order No.
HDC-KIT-HE 10.110 M		1802420000
Component	Designation	Order No.
Female	HDC HE 10 FS	1204100000
Male	HDC HE 10 MS	1203900000
Bulkhead (Feed-Through)	HDC 10B ABU	1205000000
Hood	HDC 10B TSBU 1M25G	1787550000
Cable glands	VG M25 - MS 68	1772230000
Metal housing		

F



Designation		Order No.
HDC-KIT-HE 10.111 M		1802410000
Component	Designation	Order No.
Female	HDC HE 10 FS	1204100000
Male	HDC HE 10 MS	1203900000
Bulkhead (Feed-Through)	HDC 10B ABU	1205000000
Hood	HDC 10B TOBU 1M25G	1787590000
Cable glands	VG M25 - MS 68	1772230000
Metal housing		

500 V, 16 A

PG versions



Designation		Order No.
HDC-KIT-HE 10.110		1712510000
Component	Designation	Order No.
Female	HDC HE 10 FS	1204100000
Male	HDC HE 10 MS	1203900000
Bulkhead (Feed-Through)	HDC 10B ABU	1205000000
Hood	HDC-HB-10-TSVU1/16P	1204800000
Cable glands	VG 16-MS68	1569100000
Metal housing		



Designation		Order No.
HDC-KIT-HE 10.111		1712670000
Component	Designation	Order No.
Female	HDC HE 10 FS	1204100000
Male	HDC HE 10 MS	1203900000
Bulkhead (Feed-Through)	HDC 10B ABU	1205000000
Hood	HDC-HB-10-TOVU1/16P	1204700000
Cable glands	VG 16-MS68	1569100000
Metal housing		



Designation		Order No.
HDC-KIT-HE 10.210		1712710000
Component	Designation	Order No.
Female	DSTV HE BL10 S	1848570000
Male	HDC HE 10 MS	1203900000
Bulkhead (Feed-Through)	HDC 10B ABU	1205000000
Hood	HDC-HB-10-TSVU1/16P	1204800000
Cable glands	VG 16-MS68	1569100000
Metal housing		

Kits with HE inserts, 16 pole

500 V, 16 A

metric versions



Designation		Order No.
HDC-KIT-HE 16.120 M		1802400000
Component	Designation	Order No.
Female	HDC HE 16 FS	1207700000
Male	HDC HE 16 MS	1207500000
Bulkhead (Feed-Through)	HDC 16B ABU	1208600000
Hood	HDC 16B TSBU 1M25G	1788180000
Cable glands	VG M25 - MS 68	1772230000
Metal housing		

F



Designation		Order No.
HDC-KIT-HE 16.121 M		1802390000
Component	Designation	Order No.
Female	HDC HE 16 FS	1207700000
Male	HDC HE 16 MS	1207500000
Bulkhead (Feed-Through)	HDC 16B ABU	1208600000
Hood	HDC 16B TOBU 1M25G	1788210000
Cable glands	VG M25 - MS 68	1772230000
Metal housing		

500 V, 16 A



PG versions



Designation		Order No.
HDC-KIT-HE 16.120		1712520000
Component	Designation	Order No.
Female	HDC HE 16 FS	1207700000
Male	HDC HE 16 MS	1207500000
Bulkhead (Feed-Through)	HDC 16B ABU	1208600000
Hood	HDC-HB-16-TSVU1/21P	1208400000
Cable glands	VG 21-MS68	1569110000
Metal housing		



Designation		Order No.
HDC-KIT-HE 16.121		1712680000
Component	Designation	Order No.
Female	HDC HE 16 FS	1207700000
Male	HDC HE 16 MS	1207500000
Bulkhead (Feed-Through)	HDC 16B ABU	1208600000
Hood	HDC-HB-16-TOVU1/21P	1208300000
Cable glands	VG 21-MS68	1569110000
Metal housing		



Designation		Order No.
HDC-KIT-HE 16.220		1712720000
Component	Designation	Order No.
Female	DSTV HE BL16 S	1848580000
Male	HDC HE 16 MS	1207500000
Bulkhead (Feed-Through)	HDC 16B ABU	1208600000
Hood	HDC-HB-16-TSVU1/21P	1208400000
Cable glands	VG 21-MS68	1569110000
Metal housing		

Kits with HE inserts, 24 pole

500 V, 16 A

metric versions



Designation		Order No.
HDC-KIT-HE 24.130 M		1802380000
Component	Designation	Order No.
Female	HDC HE 24 FS	1211300000
Male	HDC HE 24 MS	1211100000
Bulkhead (Feed-Through)	HDC 24B ABU	1212400000
Hood	HDC 24B TSBU 1M32G	1787750000
Cable glands	VG M32 - MS 68	1772240000
Metal housing		

F



Designation		Order No.
HDC-KIT-HE 24.131 M		1802480000
Component	Designation	Order No.
Female	HDC HE 24 FS	1211300000
Male	HDC HE 24 MS	1211100000
Bulkhead (Feed-Through)	HDC 24B ABU	1212400000
Hood	HDC 24B TOBU 1M32G	1787810000
Cable glands	VG M32 - MS 68	1772240000
Metal housing		

500 V, 16 A

PG versions



Designation		Order No.
HDC-KIT-HE 24.130		1712530000
Component	Designation	Order No.
Female	HDC HE 24 FS	1211300000
Male	HDC HE 24 MS	1211100000
Bulkhead (Feed-Through)	HDC 24B ABU	1212400000
Hood	HDC-HB-24-TSVU1/21P	1212100000
Cable glands	VG 21-MS68	1569110000
Metal housing		



Designation		Order No.
HDC-KIT-HE 24.131		1712690000
Component	Designation	Order No.
Female	HDC HE 24 FS	1211300000
Male	HDC HE 24 MS	1211100000
Bulkhead (Feed-Through)	HDC 24B ABU	1212400000
Hood	HDC-HB-24-TOVU1/21P	1211900000
Cable glands	VG 21-MS68	1569110000
Metal housing		



Designation		Order No.
HDC-KIT-HE 24.230		1712730000
Component	Designation	Order No.
Female	DSTV HE BL24 S	1848590000
Male	HDC HE 24 MS	1211100000
Bulkhead (Feed-Through)	HDC 24B ABU	1212400000
Hood	HDC-HB-24-TSVU1/21P	1212100000
Cable glands	VG 21-MS68	1569110000
Metal housing		

Kits with HE inserts, 32 pole

500 V, 16 A

metric versions



Designation		Order No.
HDC-KIT-HE 32.140 M		1802370000
Component	Designation	Order No.
Female (2x)	HDC HE 16 FS	1207700000
Male (2x)	HDC HE 16 MS	1207500000
Bulkhead (Feed-Through)	HDC 32B ABU	1217800000
Hood	HDC 32B TSBU 1M32G	1788400000
Cable glands	VG M32 - MS 68	1772240000
Metal housing		

500 V, 16 A



PG versions



Designation		Order No.
HDC-KIT-HE 32.140		1712540000
Component	Designation	Order No.
Female (2x)	HDC HE 16 FS	1207700000
Male (2x)	HDC HE 16 MS	1207500000
Bulkhead (Feed-Through)	HDC 32B ABU	1217800000
Hood	HDC-HB-32-TSVU1/29P	1217500000
Cable glands	VG 29-MS68	1569120000
Metal housing		

Kits with HE inserts, 48 pole

500 V, 16 A

metric versions



Designation		Order No.
HDC-KIT-HE 48.150 M		1802360000
Component	Designation	Order No.
Female (2x)	HDC HE 24 FS	1211300000
Male (2x)	HDC HE 24 MS	1211100000
Bulkhead (Feed-Through)	HDC 48B ADLU	1222900000
Hood	HDC HB48 TOVL M40G	1788340000
Cable glands	VG M40 - MS 68	1772250000
Metal housing		

500 V, 16 A



PG versions



Designation		Order No.
HDC-KIT-HE 48.150		1712550000
Component	Designation	Order No.
Female (2x)	HDC HE 24 FS	1211300000
Male (2x)	HDC HE 24 MS	1211100000
Bulkhead (Feed-Through)	HDC 48B ADLU	1222900000
Hood	HDC-HB-48-TSVL1/29P	1222600000
Cable glands	VG 29-MS68	1569120000
Metal housing		

Kits with HSB inserts, 6 pole

400 V, 35 A

PG versions



Designation		Order No.
HDC-KIT-HSB 06.50		1724000000
Component	Designation	Order No.
Female	HDC HSB 6 FS	1498900000
Male	HDC HSB 6 MS	1498700000
Bulkhead (Feed-Through)	HDC 16B ABU	1208600000
Hood	HDC-HB-16-TSVU1/21P	1208400000
Cable glands	VG 21-MS68	1569110000
Metal housing		

RockStar® accessories

RockStar® accessories	Crimp contacts	G.2
	RailMate mounting rail system	G.8
	Tools	G.10
	Coding	G.12
	Adapter plates / Cover plates	G.13
	Other accessories	G.14

Crimp contacts

Overview



G

Crimp contacts

Crimping is an electrically and mechanically safe and reliable connection between conductor and contact. An ideal crimp connection is gas-proof and resistant to corrosion.

Weidmüller crimp contacts are supplied in solid, turned form and are optionally available with gold or silver surface.

Fibre optic contacts.

Optical fibres guarantee interference-free transmission without any feedback – and this without additional overvoltage and explosion protection.

Fibre optic contacts can be used without any EMC problems. Their geometry is the same as the HD contacts so they can be used in HD series inserts and the ConCept modular system.

Fixed pole inserts

Technical data

	for HD and HDD inserts	for HE and HEE inserts
Material	Copper alloy	Copper alloy
Surface hard gold-plated	0.8 µm	0.8 µm
Surface hard silver-plated	3 µm	3 µm
Contact resistance	≤ 4 mΩ	≤ 4 mΩ
Clamping range	0.14 ... 2.5 mm ²	0.5 ... 4.0 mm ²
	26 ... 14 AWG	20 ... 12 AWG
Stripping length	8 mm	7.5 mm

For HD and HDD inserts

Crimp contacts

Surface Silver



Surface Gold



Qty	Male	Order No.	Female	Order No.
100	HDC-C-HD-SM0.14-0.37AG	1651520000	HDC-C-HD-BM0.14-0.37AG	1651570000
100	HDC-C-HD-SM0.5AG	1651530000	HDC-C-HD-BM0.5AG	1651580000
100	HDC-C-HD-SM0.75-1.00AG	1601750000	HDC-C-HD-BM0.75-1.00AG	1601760000
100	HDC-C-HD-SM1.5AG	1651550000	HDC-C-HD-BM1.5AG	1651600000
100	HDC-C-HD-SM2.5AG	1651560000	HDC-C-HD-BM2.5AG	1651610000
100	HDC-C-HD-SM0.14-0.37AU	1651620000	HDC-C-HD-BM0.14-0.37AU	1651670000
100	HDC-C-HD-SM0.5AU	1651630000	HDC-C-HD-BM0.5AU	1651680000
100	HDC-C-HD-SM0.75-1.00AU	1651640000	HDC-C-HD-BM0.75-1.00AU	1651690000
100	HDC-C-HD-SM1.5AU	1651650000	HDC-C-HD-BM1.5AU	1651700000
100	HDC-C-HD-SM2.5AU	1651660000	HDC-C-HD-BM2.5AU	1651710000

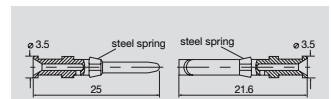

Conductor size	Stripping length
0.14 - 0.37 mm ²	AWG 26-22 8 mm
0.50 mm ²	AWG 20 8 mm
0.75 - 1.00 mm ²	AWG 18 8 mm
1.50 mm ²	AWG 16 8 mm
2.50 mm ²	AWG 14 8 mm

Tools



Crimping tool	Order No.
CTX CM 1.6 / 2.5	9018490000
Contact release tool	Order No.
Removal Tool HD	1866730000

For HE and HEE inserts and CM-HE modules

Crimp contacts

Surface Silver



Surface Gold



Qty	Male	Order No.	Female	Order No.
100	HDC-C-HE-SM0.5AG	1200500000	HDC-C-HE-BM0.5AG	1201100000
100	HDC-C-HE-SM0.75-1.00AG	1200600000	HDC-C-HE-BM0.75-1.00AG	1201200000
100	HDC-C-HE-SM1.5AG	1200700000	HDC-C-HE-BM1.5AG	1201300000
100	HDC-C-HE-SM2.5AG	1200800000	HDC-C-HE-BM2.5AG	1201400000
100	HDC-C-HE-SM4.0AG	1200900000	HDC-C-HE-BM4.0AG	1201500000
100	HDC-C-HE-SM0.5AU	1651420000	HDC-C-HE-BM0.5AU	1651470000
100	HDC-C-HE-SM0.75-1.00AU	1651430000	HDC-C-HE-BM0.75-1.00AU	1651480000
100	HDC-C-HE-SM1.5AU	1651440000	HDC-C-HE-BM1.5AU	1651490000
100	HDC-C-HE-SM2.5AU	1651450000	HDC-C-HE-BM2.5AU	1651500000
100	HDC-C-HE-SM4.0AU	1651460000	HDC-C-HE-BM4.0AU	1651510000



Conductor size	Stripping length
0.50 mm ²	AWG 20 7.5 mm
0.75 - 1.00 mm ²	AWG 18 7.5 mm
1.50 mm ²	AWG 16 7.5 mm
2.50 mm ²	AWG 14 7.5 mm
4.00 mm ²	AWG 12 7.5 mm

Tools



Crimping tool	Order No.
CTX CM 1,6 / 2,5	9018490000
Crimping tools for 4.00 mm ²	Order No.
CZB 1	9012710000
Contact release tool	Order No.
Removal Tool HE	1866750000

Crimp contacts

For ConCept modular system

Technical data

	CM-3	CM-5	CM-10	CM-20	CM-HE
Material	Copper alloy	Copper alloy	Copper alloy	Copper alloy	Copper alloy
Surface hard gold-plated			0.8 µm	0.1 ... 0.2 µm	0.8 µm
Surface hard silver-plated	3 µm	3 µm	3 µm		3 µm
Contact resistance	≤ 4 mΩ	≤ 4 mΩ	≤ 4 mΩ	≤ 4 mΩ	≤ 4 mΩ
Clamping range	1.5 ... 10 mm ²	0.75 ... 4.0 mm ²	0.14 ... 2.5 mm ²	0.08 ... 0.52 mm ²	0.5 ... 4.0 mm ²
	12 ... 7 AWG	20 ... 12 AWG	26 ... 14 AWG	28 ... 20 AWG	20 ... 12 AWG
Stripping length	10 mm	7.8 mm	8 mm	2.5 + 0.5 mm	7.4 mm

For CM-3 modules

Crimp contacts

Surface Silver



Qty	Male	Order No.	Female	Order No.
100	HDC-C-M3-SM1.5AG	1698120000	HDC-C-M3-BM1.5AG	1698130000
100	HDC-C-M3-SM2.5AG	1698140000	HDC-C-M3-BM2.5AG	1698150000
100	HDC-C-M3-SM4.0AG	1682260000	HDC-C-M3-BM4.0AG	1682270000
100	HDC-C-M3-SM6.0AG	1682280000	HDC-C-M3-BM6.0AG	1682290000
100	HDC-C-M3-SM10.0AG	1682300000	HDC-C-M3-BM10.0AG	1682310000

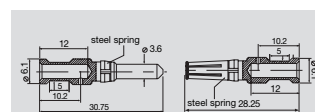

Conductor size	Stripping length
1.50 mm ²	AWG 16 10 mm
2.50 mm ²	AWG 14 10 mm
4.00 mm ²	AWG 12 10 mm
6.00 mm ²	AWG 10 10 mm
10.00 mm ²	AWG 7 10 mm

Tools



Tool description	Order No.
Crimping tool 1.5 ... 2.5 mm² CTX CM 1.6 / 2.5	9018490000
Crimping tool 4 ... 10 mm² CTX CM 3.6	9018480000
Crimping tool 1.5 ... 10 mm² HDC-CM-3	1700890000
Contact release tool Removal Tool CM3	1866710000

For CM-5 modules

Crimp contacts

Surface Silver



Qty	Male	Order No.	Female	Order No.
100	HDC-C-M5-SM0.75-1.00AG	1682340000	HDC-C-M5-BM0.75-1.00AG	1682350000
100	HDC-C-M5-SM1.5AG	1682360000	HDC-C-M5-BM1.5AG	1682370000
100	HDC-C-M5-SM2.5AG	1682380000	HDC-C-M5-BM2.5AG	1682390000
100	HDC-C-M5-SM4.0AG	1682400000	HDC-C-M5-BM4.0AG	1682410000

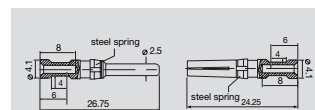

Conductor size	Stripping length
0.75 - 1.00 mm ²	AWG 18 8 mm
1.50 mm ²	AWG 16 8 mm
2.50 mm ²	AWG 14 8 mm
4.00 mm ²	AWG 12 8 mm

Tools



Tool description	Order No.
Crimping tool CTX CM 1.6 / 2.5	9018490000
Contact release tool Removal Tool CM5	1866720000

For CM-10 modules

Crimp contacts

Surface Silver



Surface Gold



Qty	Male	Order No.	Female	Order No.
100	HDC-C-HD-SM0.14-0.37AG	1651520000	HDC-C-HD-BM0.14-0.37AG	1651570000
100	HDC-C-HD-SM0.5AG	1651530000	HDC-C-HD-BM0.5AG	1651580000
100	HDC-C-HD-SM0.75-1.00AG	1601750000	HDC-C-HD-BM0.75-1.00AG	1601760000
100	HDC-C-HD-SM1.5AG	1651550000	HDC-C-HD-BM1.5AG	1651600000
100	HDC-C-HD-SM2.5AG	1651560000	HDC-C-HD-BM2.5AG	1651610000
100	HDC-C-HD-SM0.14-0.37AU	1651620000	HDC-C-HD-BM0.14-0.37AU	1651670000
100	HDC-C-HD-SM0.5AU	1651630000	HDC-C-HD-BM0.5AU	1651680000
100	HDC-C-HD-SM0.75-1.00AU	1651640000	HDC-C-HD-BM0.75-1.00AU	1651690000
100	HDC-C-HD-SM1.5AU	1651650000	HDC-C-HD-BM1.5AU	1651700000
100	HDC-C-HD-SM2.5AU	1651660000	HDC-C-HD-BM2.5AU	1651710000

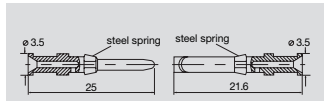

Conductor size	Stripping length
0.14 - 0.37 mm ²	AWG 26-22 8 mm
0.50 mm ²	AWG 20 8 mm
0.75 - 1.00 mm ²	AWG 18 8 mm
1.50 mm ²	AWG 16 8 mm
2.50 mm ²	AWG 14 8 mm

Tools



Crimping tool	Order No.
CTX CM 1.6 / 2.5	9018490000
Contact release tool	
Removal Tool HD	1866730000

For CM-20 modules

Crimp contacts

Surface Gold



Qty	Male	Order No.	Female	Order No.
300	HDC-C-M20-SCG0.08-0.2AU	1682420000	HDC-C-M20-SCG0.08-0.2AU	1682430000
300	HDC-C-M20-SCG0.2-0.52AU	1682440000	HDC-C-M20-SCG0.2-0.52AU	1682450000

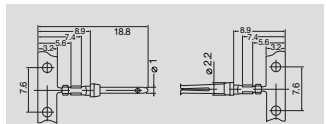

Conductor size	Stripping length
0.08 - 0.20 mm ²	AWG 28-24 2.5+0.5 mm
0.20 - 0.52 mm ²	AWG 24-20 2.5+0.5 mm

Tools



Crimping tool	Order No.
HDC-CM-20/CZC9428P	1700900000
Contact release tool	
Removal Tool CM20	1866740000

Crimp contacts

Fibre optic contacts



Fibre-optic cables guarantee interference-free transmission without any feedback.

The new fibre optic contacts enable use of fibre-optic cables in heavy-duty connectors. Their geometry is the same as the tried-and-tested HD contacts for connecting conventional copper wires, so they can be used in HD series inserts and the ConCept modular system.

It's even possible to connect optical fibres and copper wires in one connector.

The advantages at a glance:

- Immune to electromagnetic interference
- Absolute contact separation
- Weight reduction by dispensing with copper wires
- High transmission capacity and large bandwidth
- All advantages now also available for robust industrial environment
- IP65 class of protection

HDC-C-HD ... LWL 1.0 POF

Technical data

Connection for POF cable	
Maximum outer diameter	2.2 mm
Polymer fibre diameter	1.0 mm
Attenuation	
- Requirement to DIN IEC Part 7 Section 2/05.94:	< 3 dB
- the HDC-C-HD LWL contacts in plugged-in state:	< 2 dB
Mechanical system	
Plugging cycles	min. 25
Plugging force	max. 7.5 N/Pol
Removal force	max. 7.5 N/Pol
Material	
Temperature range	-40°C bis +85°C
Contact material	Nickel-silver
Over-spring	Copper alloy

Ordering data



Qty	Male	Order No.	Female	Order No.
5	HDC-C-HD-S-LWL 1.0 POF	1773630000	HDC-C-HD-B-LWL 1.0 POF	1773640000

HD inserts must be ordered separately

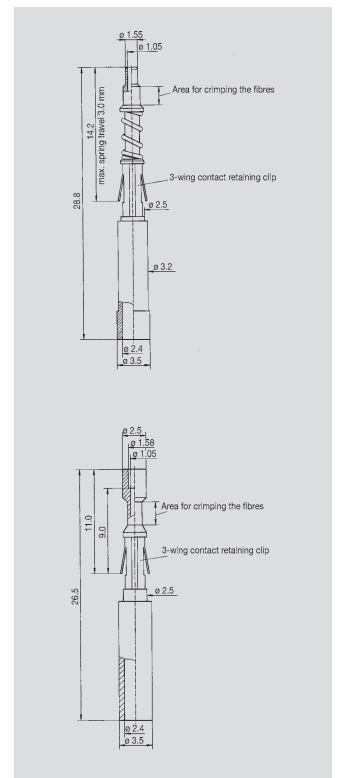

Instructions for assembling fibre optic contacts

1. Cut POF cable (polymer optical fibre) to the required length with cutting tool (we recommend the KT 8).
2. The end face of the fibre of 2.2 mm POF cables must be polished before crimping onto the fibre optic contact. Insert end of POF cable into polishing disc and polish with polishing sheet placed on a smooth surface (e.g. glass plate). Wipe away any residues after polishing. The best optical attenuation values are obtained with wet polishing.
3. Strip sheath of 2.2 mm POF cable to at least 14 mm for female contacts (HDC-C-HD-B-LWL) and at least 19 mm for male contacts (HDC-C-HD-S-LWL).
4. Crimping:
 - A. Insert POF cable into male contact, then both together into the crimping die.
 - B. The female contact has to be inserted angled slightly downwards into the die.
Make sure the end face of the contact and the plastic fibre press against the locator.
 - C. Squeeze the hand levers until the tool unlocks.
 - D. Release option in case of incorrect operation.

A. Male

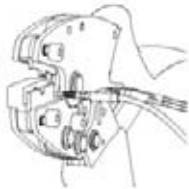

B. Female

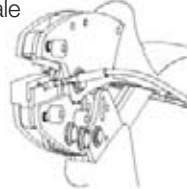

C.

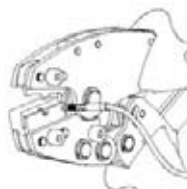

D.

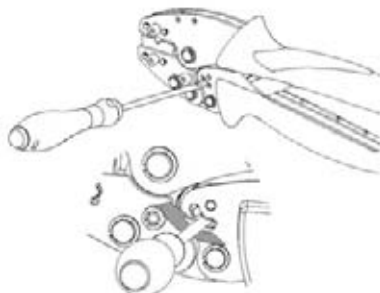

Cutting tool – KT 8



Polishing wheel for FO cables – PS LWL/POF

2.2 mm POF cable



Sheathing stripper for FO cables – AM LWL/POF



Crimping tool – HTX-HDC/POF



Ordering data for tools

	Qty	Order No.
Cutting tool , positioning sleeve included		
HKT 8	1	9002650000
Crimping tool for FO set		
HTX-HDC/POF	1	9010950000
Sheathing stripper for FO cable		
AM LWL/POF	1	9020360000
Polishing wheel for FO cable		
PS LWL/POF	1	9020390000
PB LWL/POF	1	9020400000
Polishing sheet, grit 1000		
Contact removal tool , for removing turned HD and FO contacts		
Removal Tool HD	1	1866730000

RailMate mounting rail system

For mounting rail TS 35 x 7.5 and TS 35 x 15

Cast aluminium housings are not essential within a control cabinet and RailMate may be used as an alternative IP20 solution in order to reduce costs.

This mounting rail system allows you to mount both heavy-duty connector inserts and the ConCept modular connector system on the rail. No tools are needed and connectors are simply snapped in place.

Generous labelling surfaces on the product allow for clear equipment identification.

RailMate enables users to arrange a maximum number of connections in a minimum area within the control cabinet.



Technical data

Material	PC
Properties	Phosphorous and halogen free
Colour	Pebble grey (RAL 7032)
Temperature range	-40°C ... +125°C
Flammability rating	V-0 to UL 94

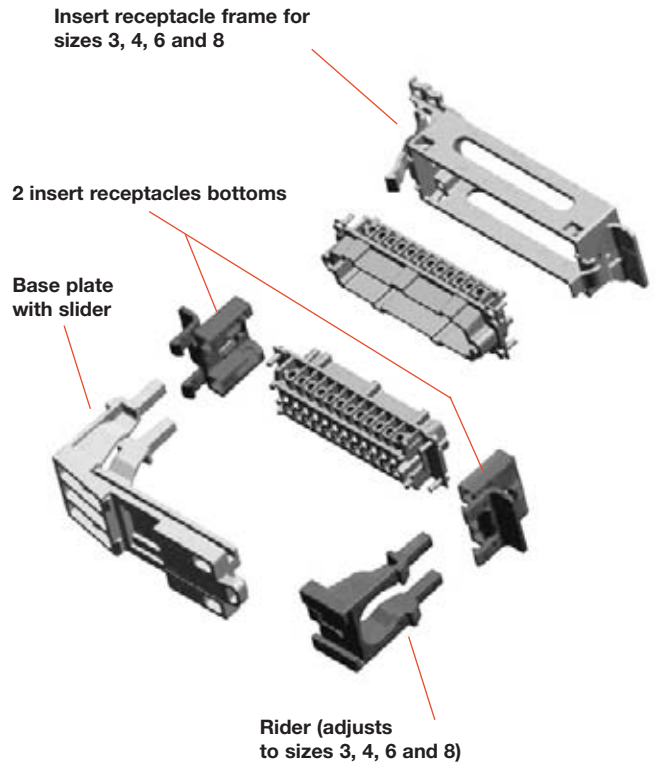

Ordering data for individual components

Type	For inserts size	Qty	Order No.
Insert receiving frame			
HDC RailMate HB6 Top	3	10	1797540000
HDC RailMate HB10 Top	4	10	1797550000
HDC RailMate HB16 Top	6	10	1797560000
HDC RailMate HB24 Top	8	10	1797570000
Base plate, tab and 2 bottom insert receptacles			
HDC RailMate Basis	3, 4, 6, 8	1	1797580000

Ordering data for sets

Type	For inserts size	Qty	Order No.
HDC RailMate HB6 Set	3	1	1797500000
HDC RailMate HB10 Set	4	1	1797510000
HDC RailMate HB16 Set	6	1	1797520000
HDC RailMate HB24 Set	8	1	1797530000
Each set consists of:			
	1 base plate		
	1 slider		
	2 bottom insert receptacles		
	1 insert receiving frame		

Accessories

Type		Qty	Order No.
Coding set			
HDC RailMate COS	50 pins and plugs 6 different code variations	1	1798260000
Marking labels for laser printers (1 sheet = 264 labels)			
LM MT 300 20/8	silver	10 sheets	1686380001
LM MT 300 20/8	white	10 sheets	1686381044
LM MT 300 20/8	yellow	10 sheets	1686381687
Marking labels for thermal transfer printers (1 Roll = 10,000 labels)			
THM MT30X 32/9	silver	1 Roll	1751770001
LM MT 300 20/8	white	1 Roll	1751771044
LM MT 300 20/8	yellow	1 Roll	1751771687

Dimensions

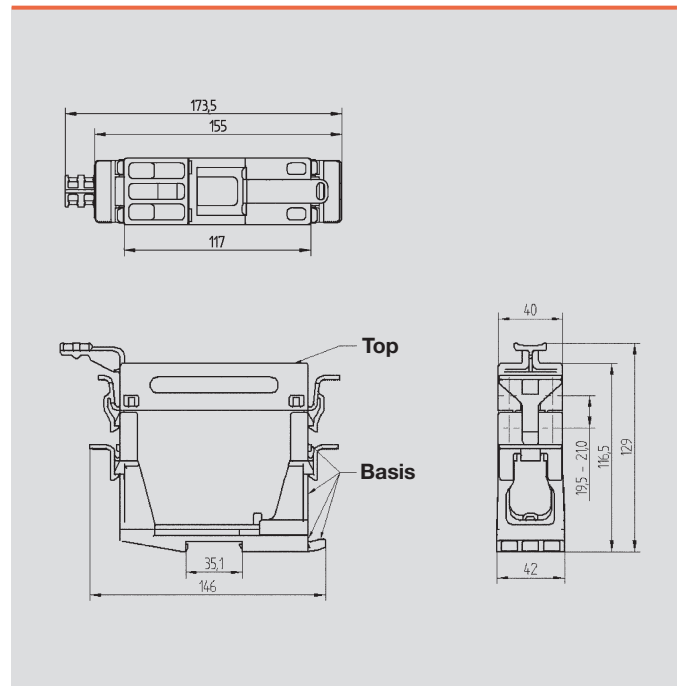

Tools

Crimping tools

- Automatic lock guarantees quality crimp
- Release option in case of incorrect operation
- With stop for exact positioning of contacts

CTX CM 1.6 / 2.5 + CM 3.6

for turned contacts



CTX CM 1.6/2.5 (0.14 ... 2.5 mm²)

- turned HD contacts
- turned HE contacts
- ConCept contacts

CTX CM 3.6 (4.0 ... 10.0 mm²)

- turned HD contacts
- ConCept M3 contacts and similar designs

CZB1 + HDC-CM-3

for turned contacts



CZB1

Crimping tool for HE series male and female contacts in the size range 0.5 ... 4.0 mm²

- 4-indent crimp

HDC-CM-3

Crimping tool for male and female contacts of CM-3 modules in the size range 1.5 ... 10 mm²

- 4-indent crimp

HDC-CM 20

Crimping tool



HDC-CM-20

Crimping tool for diameters of 1.0 mm. D-Sub contacts with 0.08 ... 0.52 mm² conductor size of ConCept CM-20 module

Length = 230 mm
Weight = 650 g

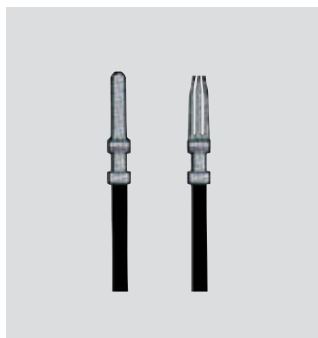
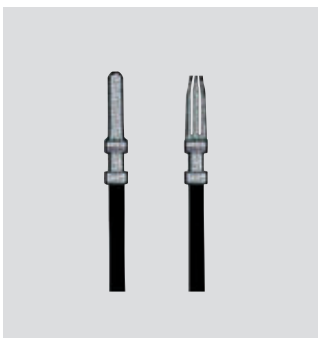
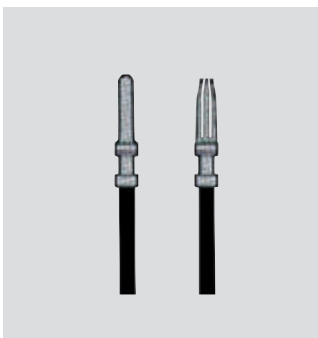

Technical data

Contact description	
Type of contact	
Crimp ranges	
Tools data	
Length	mm
Weight	g
Note	

CTX CM 1.6/2.5	CTX CM 3.6
turned contacts	turned contacts
0.14 ... 2.5 mm ²	4 ... 10 mm ²
0.14 ... 0.5 mm ²	4 mm ²
0.75 ... 1 mm ²	6 mm ²
1.5 mm ²	10 mm ²

CZB1	HDC-CM-3
HE contacts	CM-3 contacts
0.5 ... 4 mm ²	1.5 ... 10 mm ²

Ordering data

Type	Qty	Order No.
CTX CM 1.6/2.5	1	9018490000
CTX CM 3.6	1	9018480000

Type	Qty	Order No.
CZB1	1	9012710000
HDC-CM-3	1	1700890000

Ordering data

Type	Qty	Order No.
HDC CM 20	1	1700900000

Type	Qty	Order No.
HDC CM 20	1	1700900000

Removal tools

Contact removal tools



(a) (b) (c) (d)

Removal tools (a-c) for contacts CM3, CM5, HD, CM20, HE

HDC-DW-MOD

Module removal tool



Tool for removing ConCept modules from the frame

... POF

Optical fibre tools



POF sheath stripping tool AM LWL/POF

For stripping the sheathing of polymer optical fibre cables.

- Length stop with scale integrated in the tool
- Stripping direction along the fibre
- No damage to fibres

**Polishing wheel (PS LWL/POF)
Polishing sheet (PB LWL/POF)**

for polishing the cut face of optical fibres.



Crimping tool for optical fibre contacts HTX HDC/POF

- One tool for male and female contacts
- Locator on tool
- No positioning of locator needed
- Release option in case of incorrect operation
- Contacts insert from the side

Contacts:

- Fibre optic HD contacts for 1.0 mm cross-section POF

Ordering data

Type	Qty	Order No.
Removal Tool CM 3	1	1866710000
Removal Tool CM 5	1	1866720000
Removal Tool HD	1	1866730000
Removal Tool CM 20	1	1866740000
Removal Tool HE	1	1866750000
DW RSV 1.6	1	9004530000

Ordering data

Type	Qty	Order No.
HDC-DW-MOD	1	1688200000

Ordering data

Type	Qty	Order No.
AM LWL/POF		9020360000
PS LWL/POF		9020390000
PB LWL/POF		9020400000
HTX-HDC/POF		9010950000

Coding

Coding pins

Where several connectors of similar type are arranged on a machine, it is essential to avoid the risk of connectors being inserted in the wrong place.

If you have up to 6 connectors to code, Weidmüller coding pins are the simplest solution. They allow 6 secure coding variations.

In this case, you substitute 2 M3 fastening screws on the female insert by coding pins. On the male insert, you leave the opposing fastening screws where they are and substitute the others by coding pins. You then have a pair of inserts that fit together. The coding diagram illustrates the system.

Ordering data

Type	Qty	Order No.
SPB-M 3	10	1203600000



Allow 4 coding pins for each connector.

Coding arrangement for coding pins

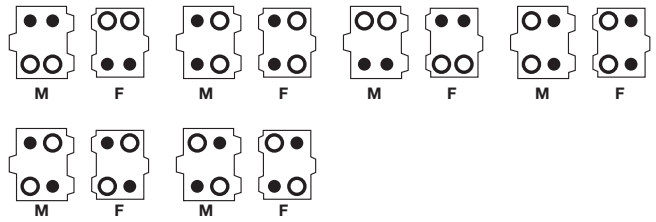

Coding system



If you have more than 6 connectors of similar type to code, you need coding pins and coding sockets.

Replace all M3 fastening screws of an insert by 2 coding pins and 2 coding sockets. You then fit 2 coding pins and 2 coding sockets to the mating insert, however in complementary arrangement.

Fit coding pins to the other connectors in the same way, but with a different arrangement. The coding diagram illustrates the system.

Ordering data

Type	Qty	Order No.
DSTV COST4	100	1471300000
DSTV COST5	100	1471500000

Cod. socket 5 mm dia 
 Cod. pin 4 mm dia 

Allow 4 coding pins for each connector

Coding arrangement for coding sockets/pins

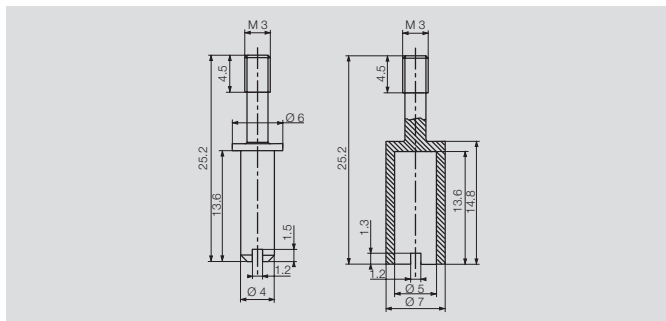
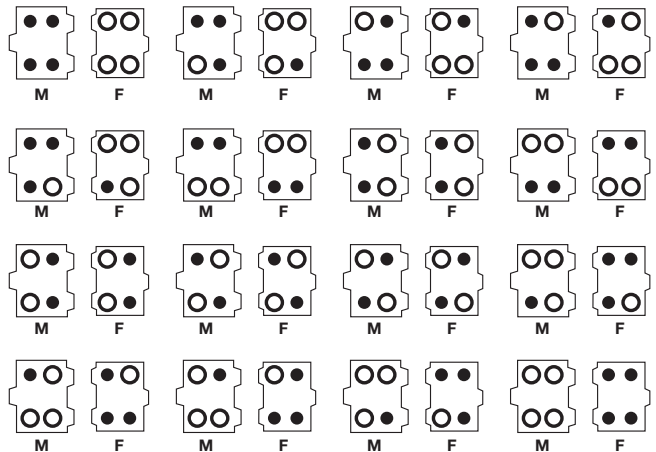

Adapter plates, plastic

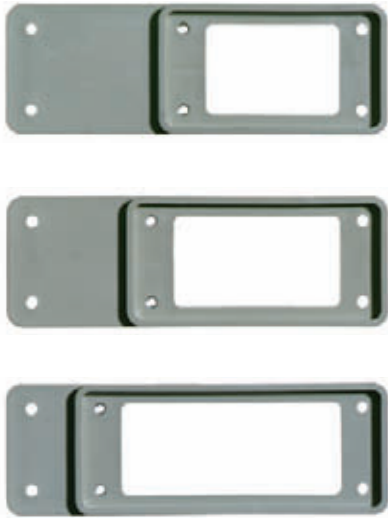

Cover plates



Adapter plates, SUB-D



Ordering data

Type	Size	Qty	Order No.
orange			
ADP-8/3-OR	3	10	1664980000
ADP-8/4-OR	4	10	1665000000
ADP-8/6-OR	6	10	1665020000
grey			
ADP-8/3-GR	3	10	1664990000
ADP-8/4-GR	4	10	1665010000
ADP-8/6-GR	6	10	1665030000

Type	Size	Qty	Order No.
Sheet steel			
ABD-1 sheet steel	1	10	9457300000
Plastic, grey			
ABD-2-GR	2	10	1664330000
ABD-3-GR	3	10	1664350000
ABD-4-GR	4	10	1664360000
ABD-5-GR	5	10	1664370000
ABD-6-GR	6	10	1664390000
ABD-8-GR	8	10	1664970000
Plastic, orange			
ABD-8-OR	8	10	1664960000

Type	Aperture	Qty	Order No.
Size 3			
ADS/6-1/9	1 x SUB-D 9	10	1665940000
ADS/6-2/9	2 x SUB-D 9	10	1665950000
ADS/6-1/15	1 x SUB-D 15	10	1666200000
ADS/6-2/15	2 x SUB-D 15	10	1666210000
Size 4			
ADS/10-1/25	1 x SUB-D 25	10	1666220000
ADS/10-2/25	2 x SUB-D 25	10	1666230000
Size 6			
ADS/16-1/25	1 x SUB-D 25	10	1666320000
ADS/16-2/25	2 x SUB-D 25	10	1666330000
ADS/16-1/37	1 x SUB-D 37	10	1666340000
ADS/16-2/37	2 x SUB-D 37	10	1666350000
ADS/16-1/50	1 x SUB-D 50	10	1666460000

Other accessories

Gaskets

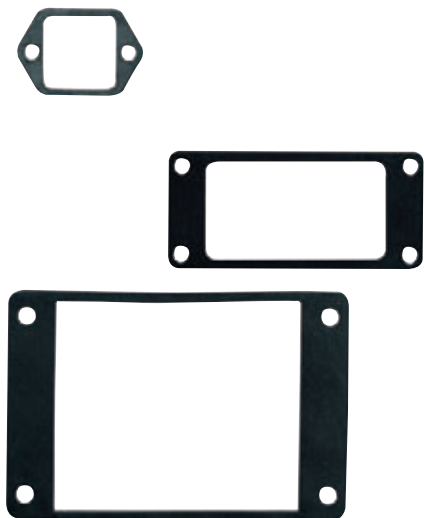

Locking foot for TS 35 mounting rail

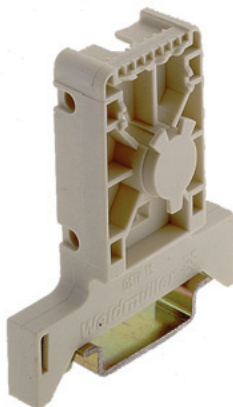

Locking hook

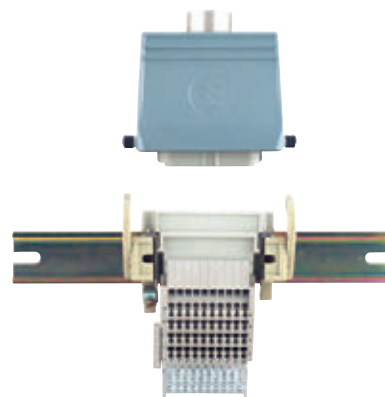

Example: DSTV-TS

Ordering data

Type	for mounted housing	Qty	Order No.
HDC-HA3 FD	HA-3	5	1739220000
HDC-HA10 FD	HA-10	5	1739200000
HDC-HA16 FD	HA-16	5	1739190000
HDC-HA32 FD	HA-32	5	1739210000
HDC-HA48 FD	HA-48	5	1855950000
HDC-HB6 FD	HB-6	5	1855960000
HDC-HB10 FD	HB-10	5	1855970000
HDC-HB16 FD	HB-16	5	1855980000
HDC-HB24 FD	HB-24	5	1855990000
HDC-HB32 FD	HB-32	5	1856000000
HDC-HB48 FD	HB-48	5	1856010000
HDC-HB10 AWVL FD	HB-10 AWVL	5	1855680000

Type	Qty	Order No.
DSTV-TS 6-24	10	1595220000

Type	Qty	Order No.
DSTV-TS 6 VH	10	1595220000
DSTV-TS 10-24 VH	10	1595240000

For all inserts apart from HA and all inserts of size 1

For all inserts apart from HA and all inserts of size 1

**Shield lever for sizes 3 (06B), 4 (10B), 6 (16B) and 8 (24B)
for fitting of shield clamps or KLBÜ 3–8 SC**

Technical data

Use	Clamping of the shield
Fastening of shield lever	To PE terminal, both sides, 2nd screw for fixing
Cable connection system	Shield clamp or KLBÜ clamping yoke
No. shield clamps or KLBÜ clamping yokes	
Size 3 (06B)	1* or 1
Size 4 (10B)	2* or 2
Size 6 (16B)	3* or 3
Size 8 (24B)	5* or 5
	* Fastening points of shield clamp, 16 mm spacing
Clamping range shield clamp	see page G.16
Material	Steel
Surface	Galvanised
Temperature range	-40°C ... +125°C

Shield lever

HDC SHIELD LEVER 3 SC

Type	Order No.
HDC SHIELD LEVER 3 SC	1867390000

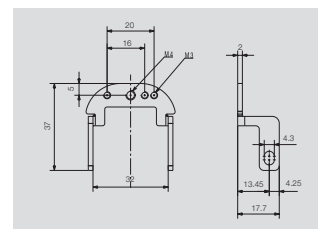

HDC SHIELD LEVER 4 SC

Type	Order No.
HDC SHIELD LEVER 4 SC	1867370000

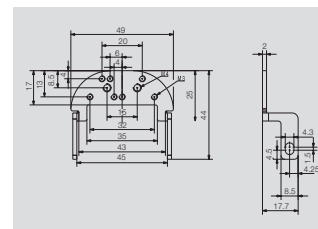

HDC SHIELD LEVER 6 SC

Type	Order No.
HDC SHIELD LEVER 6 SC	1867380000

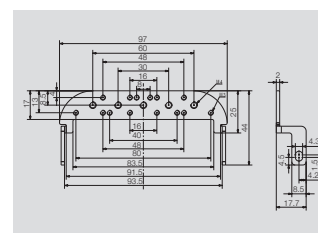

HDC SHIELD LEVER 8 SC

Type	Order No.
HDC SHIELD LEVER 8 SC	1867360000

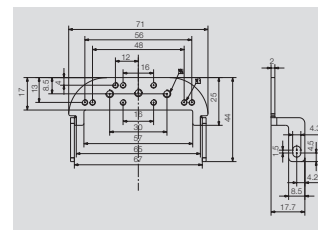

G

Other accessories

Shield clamps for shield levers of size 3 (06B), 4 (10B), 6 (16B) and 8 (24B)

Technical data

Use	Clamps shield on the shield lever	
Fastening of shield lever	With supplied fastening accessories	
Clamping range shield clamp	Cable diameter mm	Gauge of fastening holes mm
Shield clamp 10 mm	10	20
Shield clamp 9 mm	9	20
Shield clamp 8 mm	8	20
Shield clamp 7 mm	7	20
Shield clamp 6 mm	6	16
Shield clamp 5 mm	5	16
Shield clamp 4.5mm	4.5	16
Material	Steel	
Surface	Galvanised	
Temperature range	-40°C ... +125°C	

Shield clamps

Type	Order No.
HDC Shield Clamp 10.0	1912250000
HDC Shield Clamp 9	1912240000
HDC Shield Clamp 8	1912230000
HDC Shield Clamp 7	1912220000
HDC Shield Clamp 6	1912210000
HDC Shield Clamp 5	1912200000
HDC Shield Clamp 4.5	1912190000

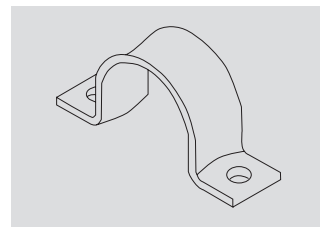

HDC GRIP PANEL 8 SC

Technical data

Use	
	To establish direct contact to bulkhead Fastened with integrated M5 screws
Advantages	
	Broad contact surface gives large-area contact Low contact resistance; high torsional rigidity Shield can be connected to grip panel
Material data Grip Panel 8 SC	
Material	Steel
Surface	Galvanised
Temperature range	-40°C to +125°C
System data	
Size	24B or 8 KLBÜ and shield clamps can be used Cable ties can be used for fixing cable

Grip panel

Type	Order No.
HDC GRIP PANEL 8 SC	1934770000

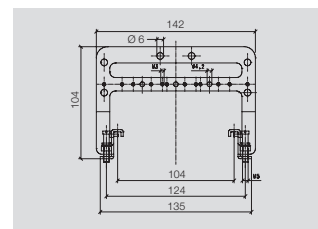

Cable entries and Cabtite

Cable entries and Cabtite

Selection guide	H.2
Standard cable glands – plastic	H.6
Standard cable glands – brass	H.8
Cable glands for Ex applications – plastic	H.10
Cable glands for Ex applications – brass	H.11
Thread sealing rings	H.12
Blanking plugs	H.13
Cabtite – Cable entry system	H.14
Cabtite – Cable grommets	H.15
Cabtite – Cable entry frames	H.16
Cabtite – Separable cable glands	H.19

Overview

In this section of the catalogue, we offer you a selected range of cable glands specifically for use with the heavy-duty connectors.







Our complete range can be found in the Enclosures catalogue.





Cable glands

The tables below provide an overview of the Weidmüller cable glands and the recommended accessories.



Standard glands

Material/Type	Approvals			Armou- ring	Thread sealing rings			Locknuts			
	IP class of protection		EX		EMV	CSM	CR	O-ring	grey	black	brass
	without seal	with seal			GWDR...Po	GWDR...NP		SKMU...K GR	SKMU...K SW	SKMU...MS	SKMU EMV...
Plastic											
 VG ... K67	IP67							●			
 VG ... K68	IP68 / 5 bar							●			
 VG ... K68 SKS	IP68 / 5 bar							●			
Nickel-plated brass											
 VG ... MS54	IP54	IP65			optional					●	
 VG ... MS68		IP68 / 5 bar					included			●	
 VG ... MS54-ZE	IP54	IP65			optional					●	
Stainless steel glands on request											

Cable glands Ex

Material/Type	Approvals			Armou- ring	Thread sealing rings			Locknuts			
	IP class of protection		EX		EMV	CSM	CR	O-ring	grey	black	brass
	without seal	with seal			GWDR...Po	GWDR...NP		SKMU...K GR	SKMU...K SW	SKMU...MS	SKMU EMV...
Plastic Ex											
 VG ... Exe SW	IP66	IP68	Exe				optional		●		
 VG ... Exi BL	IP66	IP68	EExi				optional		●		
Nickel-plated brass Ex											
 VG ... Exe MS		IP68 / 20 bar	Exe				included			●	●
Stainless steel glands on request											

Blanking plugs

Material/Type	Approvals			Armou- ring	Thread sealing rings			Locknuts			
	IP class of protection		EX		CSM	CR	O-ring	grey	black	brass	MS EMC
	without seal	with seal		GWDR...Po	GWDR...NP		SKMU...K GR	SKMU...K SW	SKMU...MS	SKMU EMV...	
Plastic											
 VP ... K54	IP54	IP66					●	●			
Nickel-plated brass											
 VP ... MS65		IP68				included				●	●

Selection guide

Cable glands

The sizes given here were calculated for multicore cables.

Please note the clamping range of the cable gland selected.

Cross-section	No. of cores	appr. cable mm
0.5 mm²	2	5.7 - 8.7
AWG 20	3	6.0 - 9.0
	4	6.7 - 9.7
	5	7.2 - 10.2
	6	7.6 - 10.6
	7	8.0 - 10.6
	8	9.4 - 12.8
	10	9.4 - 12.8
	12	9.7 - 12.9
	14	10.2 - 13.4
	16	10.7 - 13.9
	21	12.3 - 15.1
	24	13.5 - 16.7
	30	14.3 - 17.5
	35	16.0 - 18.6
	40	16.6 - 19.2
	52	19.2 - 21.6
	61	20.3 - 23.1
	80	22.9 - 25.7
	100	26.4 - 29.6

Metric thread		
12	16	20
12	16	20
12	16	20
16	20	
16	20	
16	20	
16	20	25
16	20	25
16	20	25
20	25	
20	25	
20	25	
25	32	
25	32	
25	32	
25	32	40
32	40	
32	40	
32	40	
40	50	

PG thread with onion gasket			
9			
9			
9	11		
9	11	13.5	16
9	11	13.5	16
9	11	13.5	16
9	11	13.5	16
9	11	13.5	16
11	13.5	16	
11	13.5	16	
13.5	16	21	
13.5	16	21	
16	21		
21			
21	29		
21	29		
29	36		
29	36		

Cross-section	No. of cores	appr. cable mm
0.75 mm²	2	6.8 - 9.8
AWG 18	3	7.2 - 9.7
	4	7.9 - 10.3
	5	8.9 - 10.9
	6	8.9 - 12.3
	7	9.6 - 12.3
	8	10.4 - 13.8
	9	10.7 - 13.9
	10	10.4 - 13.8
	12	10.7 - 13.9
	15	12.3 - 13.5
	18	13.0 - 16.2
	21	13.6 - 16.8
	25	15.9 - 18.5
	32	17.1 - 19.7
	40	19.0 - 21.4
	50	21.3 - 24.1
	61	22.6 - 25.4
	80	26.1 - 29.3
	100	29.4 - 33.0

Metric thread		
12	16	20
12	16	20
12	16	20
16	20	
16	20	25
16	20	25
16	20	25
20	25	
20	25	
20	25	
20	25	
25	32	
25	32	
25	32	
32	40	
32	40	
40		
40	50	
40	50	

PG thread with onion gasket			
9	11		
9	11		
9	11		
9	11	13.5	16
9	11	13.5	16
9	11	13.5	16
11	13.5	16	
11	13.5	16	
11	13.5	16	
11	13.5	16	
13.5	16		
13.5	16	21	
13.5	16	21	
21	29		
21	29		
21	29		
21	29		
21	29	36	
29	36		
29	36		
36			

Cross-section	No. of cores	appr. cable mm
1 mm²	2	7.1 - 10.1
AWG 16 - 18	3	7.5 - 10.1
	4	8.4 - 10.7
	5	9.2 - 11.4
	6	9.2 - 12.6
	7	9.2 - 12.6
	8	11.0 - 14.4
	9	11.8 - 15.2
	10	11.0 - 14.4
	12	11.8 - 14.6
	14	12.4 - 15.2
	16	13.0 - 16.2
	18	13.7 - 16.9
	20	14.4 - 17.6
	24	16.5 - 19.1
	25	16.9 - 19.5
	34	19.4 - 21.8
	48	22.0 - 24.8
	56	23.2 - 26.0
	61	24.5 - 27.2
	80	27.7 - 30.9
	100	31.8 - 35.2

Metric thread		
12	16	20
12	16	20
16	20	
16	20	25
16	20	25
16	20	25
20	25	
20	25	32
20	25	32
20	25	32
25	32	
25	32	
25	32	40
25	32	40
25	32	40
32	40	
40		
40	50	
40	50	
40	50	
40	50	63

PG thread with onion gasket			
9	11		
9	11		
9	11	13.5	
9	11	13.5	16
9	11	13.5	16
9	11	13.5	16
11	13.5	16	21
11	13.5	16	21
11	13.5	16	21
11	13.5	16	21
13.5	16	21	
13.5	16	21	
16	21		
21	29		
21	29		
21	29		
21	29	36	
29	36		
29	36		
36			
36	42		

Cross-section	No. of cores	appr. cable mm
1.5 mm²	2	8.0 - 11.0
AWG 16	3	8.7 - 11.0
	4	9.7 - 11.8
	5	10.8 - 13.0
	6	10.8 - 14.2
	7	10.8 - 14.2
	8	13.2 - 16.6
	11	13.6 - 16.8
	12	17.6 - 16.8
	14	14.4 - 17.6
	16	15.8 - 18.4
	18	16.6 - 19.2
	20	17.4 - 20.0
	25	20.2 - 23.0
	32	23.8 - 24.5
	34	22.6 - 25.4
	42	25.8 - 29.0
	50	27.0 - 30.2
	56	27.8 - 31.0
	61	28.6 - 31.8
80	33.0 - 36.4	
90	34.6 - 37.6	
100	37.8 - 41.4	

Metric thread		
12	16	20
16	20	25
16	20	25
20	25	
20	25	
20	25	
25	32	
25	32	
25	32	
25	32	
25	32	40
32	40	
40		
40		
40	50	
40	50	
40	50	
40	50	
50	63	
50	63	
50	63	

PG thread with onion gasket			
9	11	13.5	16
9	11	13.5	16
9	11	13.5	16
11	13.5	16	
11	13.5	16	
11	13.5	16	
13.5	16	21	
13.5	16	21	
13.5	16	21	
16	21		
16	21		
21	29		
21	29		
21	29		
29	36		
29	36		
29	36		
29	36		
29	36		
36			
36	42		
36	42		
42			

Cross-section	No. of cores	appr. cable mm
2.5 mm²	2	9.8 - 12.8
AWG 12 - 14	3	10.6 - 13.4
	4	11.7 - 14.4
	5	13.0 - 16.4
	6	13.3 - 16.7
	7	13.3 - 16.7
	8	17.4 - 20.8
	11	18.0 - 20.6
	16	20.6 - 23.4
	18	21.7 - 24.5
	25	26.4 - 29.6
	34	31.3 - 33.1
	50	37.0 - 39.4
	61	39.0 - 41.5

Metric thread		
16	20	25
20	25	
20	25	
20	25	32
25	32	
25	32	
25	32	40
25	32	40
32	40	
40		
40	50	
40	50	
50	63	
50	63	

PG thread with onion gasket			
9	11	13.5	16
11	13.5	16	
11	13.5	16	
13.5	16	21	
13.5	16	21	
13.5	16	21	
21	29		
21	29		
21	29		
29	36		
29	36		
29	36		
36	42		
42			
42			

Cross-section	No. of cores	appr. cable mm
4 mm²	2	10.7 - 14.1
AWG 10 - 12	4	13.0 - 16.4
	5	14.3 - 17.7
	7	16.2 - 19.6
	11	approx. 24.5

Metric thread		
20	25	
25	32	
25	32	
25	32	
40		

PG thread with onion gasket			
11	13.5	16	21
13.5	16	21	
16	21		
21	29	36	
29	36		

Standard cable glands – plastic

Glands – plastic – IP67



Inexpensive alternative for industrial applications - without approvals.

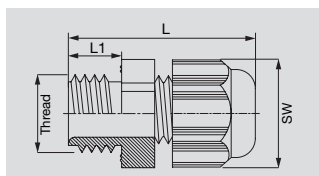

Technical data

Material / colour	Polyamide 6 / RAL 7035
Sealing ring / Sealing insert	- / TPE
Temperature range	-20 °C ... 80 °C
Class of protection	IP 67
Note	Version with moulded sealing lip Length L varies depending on the cable diameter used

Ordering data

Type metric	Thread-size	KB	L/L1	SW	Qty.	Order No.
VG M12-K67	M 12 x 1.5	3 - 6.5	23.9 / 8	15	100	1909660000
VG M16-K67	M 16 x 1.5	4 - 8	27.7 / 8	19	50	1909670000
VG M16-K67	M 16 x 1.5	5 - 10	29 / 10	22	50	1909680000
VG M20-K67	M 20 x 1.5	6 - 12	29.2 / 10	24	50	1909690000
VG M20-K67	M 20 x 1.5	10 - 14	32.8 / 10	27	50	1909700000
VG M25-K67	M 25 x 1.5	13 - 18	37.9 / 10	33	25	1909710000
VG M32-K67	M 32 x 1.5	18 - 25	40.7 / 10	42	20	1909720000
VG M40-K67	M 40 x 1.5	22 - 32	51.3 / 10	53	10	1909730000
VG M50-K67	M 50 x 1.5	30 - 38	53.5 / 18	60	10	1909740000
VG M63-K67	M 63 x 1.5	34 - 44	55 / 18	65	10	1909750000
PG						
VG PG7-K67	PG 7	3 - 6.5	23.9 / 8	15	100	1909760000
VG PG9-K67	PG 9	4 - 8	27.7 / 8	19	50	1909770000
VG PG11-K67	PG 11	5 - 10	29 / 8	22	50	1909780000
VG PG13,5-K67	PG 13.5	6 - 12	29.2 / 9	24	50	1909790000
VG PG16-K67	PG 16	10 - 14	32.8 / 9	27	50	1909800000
VG PG21-K67	PG 21	13 - 18	37.9 / 11	33	25	1909810000
VG PG29-K67	PG 29	18 - 25	40.7 / 11	42	20	1909820000
VG PG36-K67	PG 36	22 - 32	51.3 / 13	53	10	1909830000
VG PG42-K67	PG 42	30 - 38	53.5 / 13	60	10	1909840000
VG PG48-K67	PG 48	34 - 44	55 / 14	65	10	1909850000

no approvals

Glands – plastic – IP68



Plastic cable gland for industrial applications where class of protection IP 68 is called for.

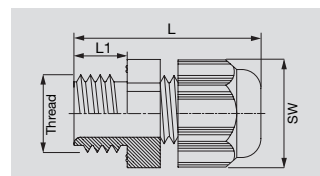

Technical data

Material / colour	Polyamide 6 / RAL 7035
Sealing ring / Sealing insert	- / CR
Temperature range	-30 °C ... 80 °C
Class of protection	IP 68 - 5 bar
Standard	EN 50262 (for metric thread)
Note	Version with moulded sealing lip Length L varies depending on the cable diameter used

Ordering data

Type metric	Thread-size	KB	L/L1	SW	Qty.	Order No.
VG M12-1/K68	M 12 x 1.5	3 - 6.5	32.4 / 8	15	100	1772280000
VG M16-1/K68	M 16 x 1.5	4.5 - 10	35.7 / 10	22	50	1909860000
VG M20-1/K68	M 20 x 1.5	6 - 12	41.2 / 10	24	50	1772300000
VG M25-1/K68	M 25 x 1.5	11 - 17	43.2 / 8	29	25	1909870000
VG M32-1/K68	M 32 x 1.5	15 - 21	50.7 / 10	36	20	1909880000
VG M40-1/K68	M 40 x 1.5	19 - 28	55.2 / 10	46	10	1909890000
VG M50-1/K68	M 50 x 1.5	27 - 38	70.3 / 18	60	10	1909900000
VG M63-1/K68	M 63 x 1.5	34 - 44	72.9 / 18	65	10	1772350000
PG						
VG 7-K68	PG 7	3 - 6.5	30.5 / 8	15	100	1568970000
VG 9-K68	PG 9	4 - 8	34 / 8	19	50	1568980000
VG 11-K68	PG 11	5 - 10	37 / 8	22	50	1568990000
VG 13,5-K68	PG 13.5	6 - 12	39 / 9	24	50	1569000000
VG 16-K68	PG 16	10 - 14	42.5 / 10	27	50	1569010000
VG 21-K68	PG 21	13 - 18	48 / 11	33	25	1569020000
VG 29-K68	PG 29	18 - 25	53 / 11	42	20	1569030000
VG 36-K68	PG 36	22 - 32	65 / 13	53	10	1569040000
VG 42-K68	PG 42	30 - 38	68 / 13	60	10	1569050000
VG 48-K68	PG 48	34 - 44	69 / 14	65	10	1718770000

VDE for metric version

Glands – plastic – SKS



Plastic gland with spiral antink protection especially for flexible connections.

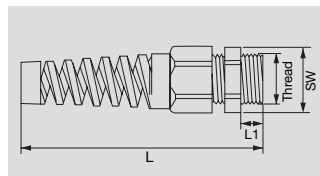

Technical data

Material / colour	Polyamide 6 / RAL 7035
Sealing ring / Sealing insert	- / CR
Temperature range	-30 °C ... 80 °C
Class of protection	IP 68 - 5 bar
Standard	EN 50262 (for metric thread)

Note	Version with moulded sealing lip Length L varies depending on the cable diameter used
-------------	--

Ordering data

Type	Thread-size	KB	L/L1	SW	Qty.	Order No.
metric						
VG M12-K68 SKS	M 12 x 1.5	3 - 6.5	66.5 / 8	15	100	1776700000
VG M16-K68 SKS	M 16 x 1.5	5 - 10	80 / 10	22	50	1776710000
VG M20-K68 SKS	M 20 x 1.5	6 - 12	106 / 11	24	50	1778860000
VG M20-K68 SKS	M 20 x 1.5	10 - 14	106 / 15	27	50	1776720000
VG M25-K68 SKS	M 25 x 1.5	13 - 18	129 / 15	33	25	1776730000
PG						
VG 7-K68 SKS	PG 7	3 - 6.5	62 / 8	15	50	1720470000
VG 9-K68 SKS	PG 9	4 - 8	78 / 8	19	50	1720480000
VG 11-K68 SKS	PG 11	5 - 10	84 / 8	22	100	1720490000
VG 13,5-K68 SKS	PG 13.5	6 - 12	105 / 9	24	50	1720500000
VG 16-K68 SKS	PG 16	10 - 14	117 / 10	27	25	1720510000
VG 21-K68 SKS	PG 21	13 - 18	130 / 11	33	20	1720520000

VDE for metric version

Standard cable glands – brass

Glands – brass – IP54



Brass cable gland for industrial applications.

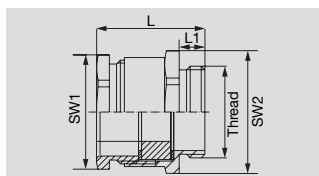

Technical data

Material	Brass, nickel-plated
Sealing ring / Sealing insert	- / soft rubber
Temperature range	-20 °C ... 60 °C
Class of protection / with GWDR	IP 54 / IP 65
Standard	DIN 46320 / C4

Note	Optional sealing ring Length L varies depending on the cable diameter used.
-------------	--

Ordering data

Type metric	Thread-size	KB	L/L1	SW1/SW2	Qty.	Order No.
VG M12-MS54	M 12 x 1.5	5 - 7	21.5 / 6	14 / 13	100	1778410000
VG M12-MS54	M 12 x 1.5	6 - 8	22 / 6	17 / 15	100	1778400000
VG M16-MS54	M 16 x 1.5	8 - 10	26 / 6	20 / 18	100	1778390000
VG M20-MS54	M 20 x 1.5	8 - 10	26.5 / 6.5	22 / 18	50	1778380000
VG M20-MS54	M 20 x 1.5	10 - 12	26.5 / 6.5	22 / 20	50	1778370000
VG M25-MS54	M 25 x 1.5	12 - 14	27.5 / 7	27 / 22	50	1778360000
VG M25-MS54	M 25 x 1.5	15 - 17	29.5 / 7	30 / 28	50	1778350000
VG M32-MS54	M 32 x 1.5	24 - 26	33 / 8	40 / 38	25	1778340000
VG M40-MS54	M 40 x 1.5	28 - 30	33 / 8	43 / 37	25	1778330000
VG M50-MS54	M 50 x 1.5	31 - 33	39 / 9	55 / 47	10	1778320000
VG M50-MS54	M 50 x 1.5	39 - 41	43 / 9	57 / 54	5	1778310000
VG M63-MS54	M 63 x 1.5	45 - 47	45 / 10	68 / 60	5	1778300000
PG						
VG 7-MS54	PG 7	5 - 7	20.5 / 5	14 / 13	100	0521500000
VG 9-MS54	PG 9	6 - 8	22 / 6	17 / 15	100	0261500000
VG 11-MS54	PG 11	8 - 10	26 / 6	20 / 18	50	0260700000
VG 13,5-MS54	PG 13.5	10 - 12	26 / 6.5	22 / 20	50	0260800000
VG 16-MS54	PG 16	12 - 14	27 / 6.5	24 / 22	50	0261400000
VG 21-MS54	PG 21	15 - 17	29.5 / 7	30 / 28	50	0260900000
VG 29-MS54	PG 29	24 - 26	33 / 8	40 / 37	25	0261000000
VG 36-MS54	PG 36	33 - 35	39 / 9	50 / 47	20	0497600000
VG 42-MS54	PG 42	41 - 43	44 / 10	57 / 54	10	0497700000
VG 48-MS54	PG 48	45 - 47	45 / 10	64 / 60	5	1718780000

Further versions on request

Half cable glands – brass – IP65



Half cable glands are designed for use in the new HDC RockStar base housings. The combination of half cable gland and housing provides IP 65 class of protection.

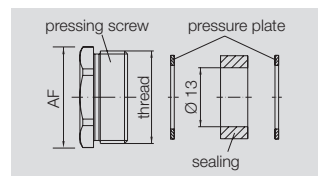

Technical data

Material:	Nickel-plated brass
- pressure screw	Nickel-plated brass
- sealing ring	SBR / NBR
- pressure ring	Polyamide
Temperature range	-20°C ... +60°C

Note

Ordering data

Type metric	Thread	Clamp. range	AF	Qty	Order No.
VG H M20 MS	M 20 x 1.5	7.0 x 10.0 x 13.0 mm	20	1	1921720000
VG H M25 MS	M 25 x 1.5	11.5 x 14.5 x 18.0 mm	25	1	1921740000
VG H M32 MS	M 32 x 1.5	19.0 x 22.0 x 25.0 mm	32	1	1921760000
VG H M40 MS	M 40 x 1.5	26.0 x 29.0 x 32.0 mm	40	1	1921770000
PG					
KV 11 - M	PG 11	10.0 x 12.5 mm	18	10	1656390000
KV 13 - M	PG 13.5	10.0 x 11.0 x 12.0 mm	24	10	1656400000
KV 16 - M	PG 16	10.0 x 12.5 x 15.0 mm	22	10	1656410000
KV 21 - M	PG 21	13.0 x 16.0 x 19.0 mm	28	10	1656420000
KV 29 - M	PG 29	21.0 x 24.0 x 27.0 mm	37	10	1656430000
KV 42 - M	PG 42	41.0 x 42.0 x 43.0 mm	65	5	1656450000

Glands – brass – IP68



Brass cable gland for industrial applications where class of protection IP 68 is called for.

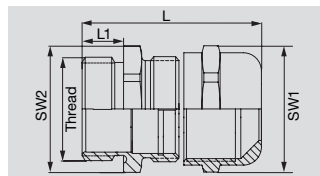

Technical data

Material	Brass, nickel-plated
Sealing ring / Sealing insert	- / CR
Temperature range	-40 °C ... 100 °C
Class of protection / with GWDR	IP 68 / IP 68 - 5 bar

Note Length L varies according to cable diameter used

Ordering data

Type metric	Thread-size	KB	L/L1	SW1/SW2	Qty.	Order No.
VG M12-1/MS68	M 12 x 1.5	3 - 6.5	27.2 / 5	14	50	1772200000
VG M16-1/MS68	M 16 x 1.5	4.5 - 10	37.3 / 7.5	20	50	1909910000
VG M20-1/MS68	M 20 x 1.5	6 - 12	32 / 8	22	50	1772200000
VG M25-1/MS68	M 25 x 1.5	11 - 17	42 / 8	27	25	1909920000
VG M32-1/MS68	M 32 x 1.5	15 - 21	45 / 8	34	20	1909930000
VG M40-1/MS68	M 40 x 1.5	19 - 28	55.1 / 9	43	20	1909940000
VG M50-1/MS68	M 50 x 1.5	27 - 38	62.2 / 9	58	12	1909950000
VG M63-1/MS68	M 63 x 1.5	34 - 44	63.6 / 14	68 / 64	12	1772270000
PG						
VG 7-MS68	PG 7	3 - 6.5	23 / 5	14	50	1569060000
VG 9-MS68	PG 9	4 - 8	27 / 6	17	50	1569070000
VG 11-MS68	PG 11	5 - 10	28.5 / 6	20	50	1569080000
VG 13,5-MS68	PG 13.5	6 - 12	29.5 / 6.5	22	50	1569090000
VG 16-MS68	PG 16	10 - 14	29.5 / 6.5	24	25	1569100000
VG 21-MS68	PG 21	13 - 18	33.5 / 7	30	25	1569110000
VG 29-MS68	PG 29	18 - 25	37.5 / 8	40	20	1569120000
VG 36-MS68	PG 36	22 - 32	45 / 9	50	15	1569130000
VG 42-MS68	PG 42	30 - 38	47.5 / 10	58	12	1569140000
VG 48-MS68	PG 48	34 - 44	50.5 / 10	64	12	1718790000

Further versions on request
VDE for metric versions

Glands – brass – ZE



Brass cable gland with external concentric strain relief by means of clamping jaws.

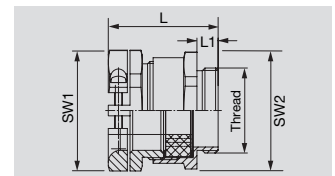

Technical data

Material	Brass, nickel-plated
Sealing ring / Sealing insert	- / CR
Temperature range	-30 °C ... 90 °C
Class of protection / with GWDR	IP 54 / IP 65

Note Optional sealing ring
Length L varies depending on the cable diameter used.

Ordering data

Type metric	Thread-size	KB	L/L1	SW1/SW2	Qty.	Order No.
VG M12-MS54 ZE	M 12 x 1.5	5 - 7	21.5 / 6	14	100	1778420000
VG M16-MS54 ZE	M 16 x 1.5	4 - 9.5	26 / 6	18	100	1778440000
VG M20-MS54 ZE	M 20 x 1.5	6 - 11.5	26.5 / 6.5	22	50	1778450000
VG M20-MS54 ZE	M 20 x 1.5	6 - 13.5	26.5 / 6.5	22	50	1778460000
VG M25-MS54 ZE	M 25 x 1.5	9 - 21.5	29.5 / 7	30	50	1778480000
VG M32-MS54 ZE	M 32 x 1.5	17 - 29.5	33 / 8	39	25	1778490000
VG M40-MS54 ZE	M 40 x 1.5	23 - 36.5	33 / 8	43	25	1778500000
VG M50-MS54 ZE	M 50 x 1.5	29 - 42.5	43 / 9	57	5	1778520000
VG M63-MS54 ZE	M 63 x 1.5	35 - 46.5	45 / 10	68	5	1778530000
PG						
VG 7-MS54-ZE	PG 7	5 - 7	27 / 5	14 / 16	50	1718800000
VG 9-MS54-ZE	PG 9	4 - 11	30.5 / 6	17 / 19	50	1718810000
VG 11-MS54-ZE	PG 11	6 - 13	31.5 / 6	20 / 22	50	1718820000
VG 13,5-MS54-ZE	PG 13.5	6 - 13	32 / 6.5	22 / 24	50	1718830000
VG 16-MS54-ZE	PG 16	6 - 16	33 / 6.5	24 / 27	50	1718840000
VG 21-MS54-ZE	PG 21	9 - 20	38 / 7	30 / 34	50	1718850000
VG 29-MS54-ZE	PG 29	17 - 28	43 / 8	40 / 42	25	1718860000
VG 36-MS54-ZE	PG 36	23 - 34	49.5 / 9	50 / 52	10	1718870000
VG 42-MS54-ZE	PG 42	29 - 40	53.5 / 10	57 / 62	5	1718880000
VG 48-MS54-ZE	PG 48	35 - 46	55 / 10	64 / 68	5	1718890000

Further versions on request

Cable glands for Ex applications – plastic

Glands – plastic – Ex e, IP 66 / IP 68



Black plastic cable gland with integral strain relief - especially for Ex applications. Complete with integral membrane seal for clean transportation and storage.

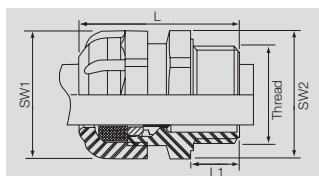

Technical data

Material / colour	Polyamide / RAL 9005
Sealing ring / Sealing insert	- / TPE
Temperature range	-20 °C ... 80 °C
Class of protection / with GWDR	IP 66 / IP 68
Approval	EEx e II; Ⓢ II 2 GD
Test certificate	LCIE 97ATEX6007 X

Note Optional sealing ring
Length L varies depending on the cable diameter used.

Ordering data

Type metric	Thread-size	KB	L/L1	SW1/SW2	Qty.	Order No.
VG M16-EXE SW	M 16 x 1,5	5 - 8	34 / 12	19	20	1737280000
VG M20-EXE SW	M 20 x 1,5	8 - 13	35 / 12	24	20	1737290000
VG M25-EXE SW	M 25 x 1,5	13 - 19	42 / 13	32	20	1737300000
VG M32-EXE SW	M 32 x 1,5	17 - 25	44 / 15	41	10	1737310000
VG M40-EXE SW	M 40 x 1,5	24 - 32	50 / 15	52	10	1737320000
VG M50-EXE SW	M 50 x 1,5	29 - 38	56 / 16	59	5	1737330000
VG M63-EXE SW	M 63 x 1,5	36 - 44	58 / 16	65	5	1737340000
PG						
VG 7-EXE SW	PG 7	3,5 - 6	27 / 9	15	50	1569360000
VG 9-EXE SW	PG 9	5 - 8	31 / 9	19	20	1490500000
VG 11-EXE SW	PG 11	6 - 10	31 / 9	22	20	1490600000
VG 13,5-EXE SW	PG 13,5	8 - 13	33 / 10	24	20	1490700000
VG 16-EXE SW	PG 16	10 - 15	33 / 10	26	20	1490800000
VG 21-EXE SW	PG 21	13 - 19	40 / 11	32	20	1490900000
VG 29-EXE SW	PG 29	17 - 25	41 / 12	41	10	1491000000
VG 36-EXE SW	PG 36	24 - 32	49 / 14	52	10	1491100000
VG 42-EXE SW	PG 42	28 - 38	56 / 16	59	10	1491200000
VG 48-EXE SW	PG 48	34 - 44	60 / 16	65	5	1718970000

Further versions on request

Glands – plastic – EEx i, IP 66 / IP 68



Blue plastic gland with integral strain relief - especially for Ex applications. Complete with integral membrane seal for clean transportation and storage.

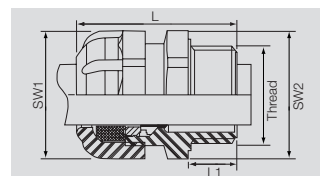

Technical data

Material / colour	Polyamide / RAL 5012
Sealing ring / Sealing insert	- / TPE
Temperature range	-20 °C ... 80 °C
Class of protection / with GWDR	IP 66 / IP 68
Approval	EEx e II; Ⓢ II 2 GD
Test certificate	LCIE 97ATEX6007 X

Note Optional sealing ring
Length L varies depending on the cable diameter used.

Ordering data

Type metric	Thread-size	KB	L/L1	SW1/SW2	Qty.	Order No.
VG M16-EXI BL	M 16 x 1,5	5 - 8	34 / 12	19	20	1737350000
VG M20-EXI BL	M 20 x 1,5	8 - 13	35 / 12	24	20	1737360000
VG M25-EXI BL	M 25 x 1,5	13 - 19	42 / 13	32	20	1737370000
VG M32-EXI BL	M 32 x 1,5	17 - 25	44 / 15	41	10	1737380000
VG M40-EXI BL	M 40 x 1,5	24 - 32	50 / 15	52	10	1737390000
VG M50-EXI BL	M 50 x 1,5	29 - 38	56 / 16	59	5	1737400000
VG M63-EXI BL	M 63 x 1,5	36 - 44	58 / 16	65 / 67	5	1737410000
PG						
VG 7-EXI BL	PG 7	3,5 - 6	27 / 9	15	50	1569370000
VG 9-EXI BL	PG 9	5 - 8	31 / 9	19	20	1491300000
VG 11-EXI BL	PG 11	6 - 10	31 / 9	22	20	1491400000
VG 13,5-EXI BL	PG 13,5	8 - 13	33 / 10	24	20	1491500000
VG 16-EXI BL	PG 16	10 - 15	33 / 10	26	20	1491600000
VG 21-EXI BL	PG 21	13 - 19	40 / 11	32	20	1491700000
VG 29-EXI BL	PG 29	17 - 25	41 / 12	41	10	1491800000
VG 36-EXI BL	PG 36	24 - 32	49 / 14	52	10	1491900000
VG 42-EXI BL	PG 42	28 - 38	56 / 16	59	10	1492000000
VG 48-EXI BL	PG 48	34 - 44	60 / 16	65	5	1718980000

Further versions on request

Glands – brass – Ex e, IP 68



Brass cable gland for use in Ex applications EEx i und Ex e.

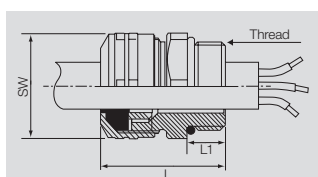

Technical data

Material	Brass, nickel-plated
Sealing ring / Sealing insert	- / CR
Temperature range	-40 °C ... 100 °C
Class of protection / with GWDR	IP 66 / IP 68 - 20 bar
Approval	EEx e II; Ⓜ II 2 GD
Test certificate	LCIE 97ATEX6005 X

Note Length L varies according to cable diameter used

Ordering data

Type	Thread-size	KB	L/L1	SW	Qty.	Order No.
metric						
VG M16-EXE MS	M 16 x 1.5	7 - 11	28 / 8	22	50	1737210000
VG M20-EXE MS	M 20 x 1.5	8,5 - 13	28 / 8	24	50	1737220000
VG M25-EXE MS	M 25 x 1.5	13,5 - 18	33 / 9	30	20	1737230000
VG M32-EXE MS	M 32 x 1.5	17,5 - 25	38 / 10	41	20	1737240000
VG M40-EXE MS	M 40 x 1.5	24,5 - 33,5	49 / 11	52	10	1737250000
VG M50-EXE MS	M 50 x 1.5	33 - 43	54 / 12	63	5	1737260000
VG M63-EXE MS	M 63 x 1.5	43,5 - 55	60 / 13	77	5	1737270000
PG						
VG 7-EXE MS	PG 7	4 - 8	24 / 7	18	50	1718990000
VG 9-EXE MS	PG 9	6 - 11	28 / 8	22	50	1719000000
VG 11-EXE MS	PG 11	7,5 - 13	28 / 8	24	50	1719010000
VG 13,5-EXE MS	PG 13,5	7,5 - 13	32 / 8	24	50	1719020000
VG 16-EXE MS	PG 16	12,5 - 18	33 / 9	30	25	1719030000
VG 21-EXE MS	PG 21	17,5 - 23,5	38 / 10	41	20	1719040000
VG 29-EXE MS	PG 29	24,5 - 31,5	49 / 11	52	20	1719050000
VG 36-EXE MS	PG 36	33 - 40,5	54 / 12	63	10	1719060000
VG 42-EXE MS	PG 42	33 - 43	54 / 12	63	10	1719070000
VG 48-EXE MS	PG 48	33 - 43	60 / 13	77	5	1719080000

Further versions - also in stainless steel - available on request

Thread sealing rings

Sealing rings – standard



For increasing the class of protection for cable glands and blanking plugs.

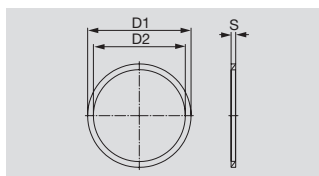

Technical data

Material / colour	Polyethylene / -
Temperature range	-30 °C ... 90 °C
Standard	DIN 46320 (for PG thread)

Note

Ordering data

Type metric	Thread-size	D1	D2	S	Qty.	Order No.
GWDR M12-PO	M 12 x 1.5	16	12	1.5	50	1777920000
GWDR M16-PO	M 16 x 1.5	20	16	1.5	50	1777930000
GWDR M20-PO	M 20 x 1.5	24	20	2	100	1777940000
GWDR M25-PO	M 25 x 1.5	29	25	2	50	1777950000
GWDR M32-PO	M 32 x 1.5	36	32	2	50	1777960000
GWDR M40-PO	M 40 x 1.5	44	40	2	50	1777970000
GWDR M50-PO	M 50 x 1.5	54	50	2	50	1777980000
GWDR M63-PO	M 63 x 1.5	67	63	2	50	1777990000
PG						
GWDR PG7-PO	PG 7	16.5	12.5	1.6	100	1719440000
GWDR PG9-PO	PG 9	19	15.3	1.6	100	1719450000
GWDR PG11-PO	PG 11	22.5	18.6	1.8	100	1719460000
GWDR PG13,5-PO	PG 13.5	25	20.4	1.8	100	1719470000
GWDR PG16-PO	PG 16	27	22.5	1.8	100	1719480000
GWDR PG21-PO	PG 21	33.5	28.5	2.2	100	1719490000
GWDR PG29-PO	PG 29	43.5	37	2.2	50	1719500000
GWDR PG36-PO	PG 36	55	47	2.7	50	1719510000
GWDR PG42-PO	PG 42	63	54	3.2	10	1719520000
GWDR PG48-PO	PG 48	69	59.3	3.2	5	1719530000

Further versions on request

Sealing rings – 9005



For increasing the class of protection for cable glands and blanking plugs - recommended for use in Ex applications.

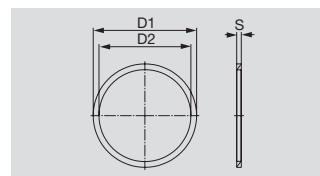

Technical data

Material / colour	Neoprene / RAL 9005
Temperature range	-40 °C ... 100 °C
Standard	DIN 46320 (for PG thread)

Note

Ordering data

Type metric	Thread-size	D1	D2	S	Qty.	Order No.
GWDR M12-NP	M 12	18	12	1.2	50	1913320000
GWDR M16-NP	M 16	22	16	1.2	50	1736230000
GWDR M20-NP	M 20	24	20	1.2	50	1736240000
GWDR M25-NP	M 25	30	25	1.5	50	1736250000
GWDR M32-NP	M 32	42	32	1.5	50	1736260000
GWDR M40-NP	M 40	52	40	1.5	20	1736270000
GWDR M50-NP	M 50	63	50	1.5	20	1736280000
GWDR M63-NP	M 63	77	63	2	10	1736290000
PG						
GWDR PG7-NP	PG 7	17	11.6	1.2	100	1719540000
GWDR PG9-NP	PG 9	21	14	1.2	100	1719550000
GWDR PG11-NP	PG 11	24	17	1.2	100	1719560000
GWDR PG13,5-NP	PG 13.5	27	19.5	1.2	100	1719570000
GWDR PG16-NP	PG 16	30	22.5	1.2	100	1719580000
GWDR PG21-NP	PG 21	35	28.3	1.5	100	1719590000
GWDR PG29-NP	PG 29	45	37	1.5	50	1719600000
GWDR PG36-NP	PG 36	60	47	1.5	20	1719610000
GWDR PG42-NP	PG 42	65	54	1.5	10	1719620000
GWDR PG48-NP	PG 48	71	59.3	1.5	5	1719630000

Further versions on request

Sealing plugs – plastic



For sealing surplus threaded holes to maintain the IP class of protection.

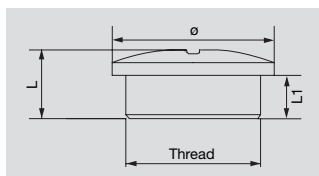

Technical data

Material / colour	Polyamide 6 / RAL 7035
Sealing ring	-
Temperature range	-40 °C ... 100 °C
Class of protection / with GWDR	IP 54 / IP 66
Standard	DIN 46320 (for PG thread)

Note	Optional sealing ring
------	-----------------------

Ordering data

Type metric	Thread-size	L	L1	Top dia.	Qty.	Order No.
VP M12 K54	M 12 x 1.5	10	6	15	100	1776930000
VP M16 K54	M 16 x 1.5	11.5	7	19	100	1776920000
VP M20 K54	M 20 x 1.5	12.5	7.5	22	100	1776910000
VP M25 K54	M 25 x 1.5	15	11	27	100	1776900000
VP M32 K54	M 32 x 1.5	16	11	34	100	1776940000
VP M40 K54	M 40 x 1.5	18	12	42	50	1776950000
VP M50 K54	M 50 x 1.5	20	13	52	25	1776960000
VP M63 K54	M 63 x 1.5	20	14	65	50	1776970000
PG						
VP 7-K54	PG 7	8	6	15	50	1719250000
VP 9-K54	PG 9	9	6	19	100	0294760000
VP 11-K54	PG 11	10.5	6.5	22	100	0294860000
VP 13,5-K54	PG 13.5	9.5	6	25	100	0294960000
VP 16-K54	PG 16	9.5	6	27	100	0295060000
VP 21-K54	PG 21	11	8	33	100	0295160000
VP 29-K54	PG 29	12	8	44	50	0501160000
VP 36-K54	PG 36	15	10	55	25	0501260000
VP 42-K54	PG 42	16	10	62	10	0501360000
VP 48-K54	PG 48	16	12	69	5	1719260000

Further versions on request

Sealing plugs – brass



For sealing surplus threaded holes to maintain the IP class of protection.

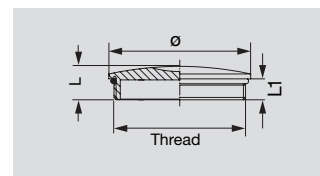

Technical data

Material / colour	Brass, nickel-plated / -
Sealing ring	-
Temperature range	-30 °C ... 100 °C
Class of protection / with GWDR	- / IP 68

Note	
------	--

Ordering data

Type metric	Thread-size	L	L1	Top dia.	Qty.	Order No.
VP M12-MS65	M 12 x 1.5	7.4	5	14	100	1777720000
VP M16-MS65	M 16 x 1.5	8	6	20	100	1777730000
VP M20-MS65	M 20 x 1.5	9.4	6.5	22	100	1777740000
VP M25-MS65	M 25 x 1.5	10.8	7	28	100	1777750000
VP M32-MS65	M 32 x 1.5	11.6	8	35	50	1777760000
VP M40-MS65	M 40 x 1.5	12.3	8	45	50	1777770000
VP M50-MS65	M 50 x 1.5	15	9	55	25	1777780000
VP M63-MS65	M 63 x 1.5	18	10	68	10	1777790000
PG						
VP 7-MS65	PG 7	8	5	15	100	0521600000
VP 9-MS65	PG 9	8	4.5	18	100	0294700000
VP 11-MS65	PG 11	8	5	22	100	0294800000
VP 13,5-MS65	PG 13.5	9.5	6	24	100	0294900000
VP 16-MS65	PG 16	9	6	26	100	0295000000
VP 21-MS65	PG 21	11	6	32	100	0295100000
VP 29-MS65	PG 29	12	8	40	50	0501100000
VP 36-MS65	PG 36	15	9	50	25	0501200000
VP 42-MS65	PG 42	16	10	57	10	0501300000
VP 48-MS65	PG 48	16	10	64	5	1719270000

Further versions on request

Cabtite – Cable entry system

Do you really need a plug-in connector on the outside of your switchgear cabinet?

Or do you simply just want to make the right connections?

Now you can save space, time and money with Cabtite.

Cabtite makes it possible for you to insert your pre-assembled connectors through the cabinet wall and, at the same time, achieves a minimum protection classification of IP54.

The manufacturer's guarantee remains valid because the cable does not have to be cut.

The individual elements of the system result in countless combination options because the same sealing grommets are utilised for the entry frames and the cable glands.

In particular, when used for measurement circuits, servo cables, computer cables or fieldbus systems, Cabtite is suitable for use in the following applications:

- Control engineering
- Switchgear cabinet manufacture
- Motor vehicle manufacture
- Systems engineering
- Mechanical engineering
- Electrical installation

Cabtite KEL SNAP frame



Separable cable gland Cabtite KVT



Cabtite sample set

Get a feel for the Cabtite system with our Cabtite sample set. It contains cable entry frames, snap frames, separable cable glands as well as diverse cable grommets.

Ordering data

Type	Qty	Order No.
Cabtite Sample Kit	1	1849780000

HDC KT ...

Cable grommets, small



Cable grommets for ASI cables

Technical data

Material, grey	Free from elastomers, halogens and silicone
Material, black	Elastomers with very high chemical resistance
Temperature range	-20 °C ... 80 °C
UL94 flammability rating	V0

Ordering data

Type	Clamping range [mm]	Qty	Order No. grey	Order No. black
HDC KT 3	3-4	10	1826460000	1827790000
HDC KT 4	4-5	10	1826470000	1827800000
HDC KT 5	5-6	10	1826480000	1827810000
HDC KT 6	6-7	10	1826490000	1827830000
HDC KT 7	7-8	10	1826500000	1827840000
HDC KT 8	8-9	10	1826510000	1827850000
HDC KT 9	9-10	10	1826520000	1827860000
HDC KT 10	10-11	10	1826530000	1827870000
HDC KT 11	11-12	10	1826540000	1827880000
HDC KT 12	12-13	10	1826550000	1827890000
HDC KT 13	13-14	10	1826560000	1827900000
HDC KT 14	14-15	10	1826570000	1827910000
HDC KT 15	15-16	10	1826580000	1827920000
HDC KTS 16	16-17	10	1826590000	1827930000
HDC KTS 17	17-18	10	1826600000	1827940000
for ASI cables				
HDC KT-ASI		10	1826610000	1828120000
2 or 4 openings				
HDC KT 2/4	2 x 4	10	1826620000	1828130000
HDC KT 2/5	2 x 5	10	1826630000	1828140000
HDC KT 2/6	2 x 6	10	1826640000	1828150000
HDC KT 4/5	4 x 5	10	1826650000	1828160000
Blanking plugs, small				
HDC BTK		10	1828170000	1828200000

HDC KT ...

Cable grommets, large

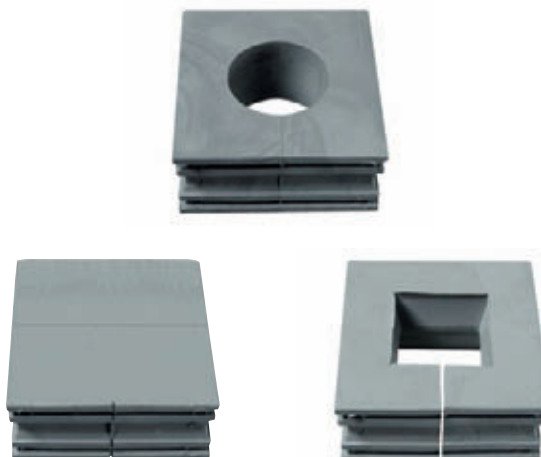

Blanking plugs

Adapter grommet

Technical data

Material, grey	Free from elastomers, halogens and silicone
Material, black	Elastomers with very high chemical resistance
Temperature range	-20 °C ... 80 °C
UL94 flammability rating	V0

Ordering data

Type	Clamping range [mm]	Qty	Order No. grey	Order No. black
HDC KT 16	16-17	10	1825950000	1827950000
HDC KT 17	17-18	10	1826300000	1827960000
HDC KT 18	18-19	10	1826310000	1827970000
HDC KT 19	19-20	10	1826320000	1827980000
HDC KT 20	20-21	10	1826330000	1827990000
HDC KT 21	21-22	10	1826340000	1828000000
HDC KT 22	22-23	10	1826350000	1828010000
HDC KT 23	23-24	10	1826360000	1828020000
HDC KT 24	24-25	10	1826370000	1828030000
HDC KT 25	25-26	10	1826380000	1828040000
HDC KT 26	26-27	10	1826390000	1828050000
HDC KT 27	27-28	10	1826400000	1828060000
HDC KT 28	28-29	10	1826410000	1828070000
HDC KT 29	29-30	10	1826420000	1828080000
HDC KT 30	31-32	10	1826430000	1828090000
HDC KT 32	32-33	10	1826440000	1828100000
HDC KT 34	33-34	10	1826450000	1828110000
Adapter grommet, large (for small cable grommets)				
HDC ATG		10	1828190000	1828220000
Blanking plugs, large				
HDC BTG		10	1828180000	1828210000

Cabtite KEL

Cabtite KEL

The rectangular panel cutout frames fit exactly into the standard cutout for heavy-duty connectors.

This makes it possible to accommodate up to 40 connectors in a very confined space.

- Feeds through prefabricated wiring in confined spaces.
- Two-piece, two-tier system
- Fast and easy mounting
- Standard panel cutout frames for 16- and 24-pole industrial plug-in connectors
- The predefined gap achieves a minimum class of protection of IP54
- Large numbers of cables in very confined spaces
- Retrofitting of prefabricated wiring also possible
- The manufacturer's guarantee covering the prefabricated cables remains valid
- Integral strain relief to VDE 0619
- Locknuts ensure that working "overhead" is safe and simple

Operating mode

1. The grommet is fitted around the cable.

Important:

Choose a grommet with an appropriate clamping range for the diameter of the cable!



2. Press the grommet with the cable into the open cable entry frame.

Important:

The flat side of the grommet must face upwards!

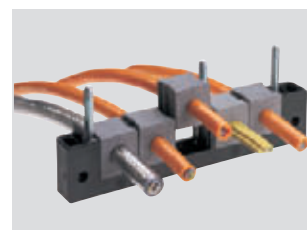

3. Assemble the two halves of the cable entry frame using the M5x50 Allen screws supplied. This achieves integral strain relief in accordance with VDE 0619 (VDE = German Association for Electrical, Electronic and Information Technologies).

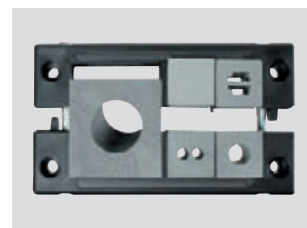

4. Finally, the rubber seal is glued around the cabinet panel cutout and the cable entry frame is secured with 4 screws. The cable entry is now complete, and has a protection class of IP54!



Cabtite KEL SNAP frame

Snap frame for mounting the cable entry frame in the switchgear cabinet.

- The KEL can be fitted quickly without tools
- The KEL need not be fitted or removed to add or remove individual cables
- The drilling pattern is identical with that of the KEL
- Seals are already integrated on both sides
- Switchgear cabinets can be fitted with KEL SNAP in advance
- KEL SNAP is available for KEL 16 and KEL 24



Advantage: The panel cutout frames are the same as those used for heavy-duty connectors. They are supplied by the switchgear cabinet manufacturers. You do not require a new punching die!

HDC KEL 16

Size equivalent to 16-pole HE inserts

KEL 16/8 with 8 small grommets



KEL 16/4 closed half-shell and 4 small grommets



Snap frame
KEL 16 SNAP



Technical data

Material	Polyamide, free from halogenes and silicone
Colour	black
Temperature range	-20°C ... 80°C
Class of protection	IP54, when the correct cable grommet is selected
UL94 flammability rating	V0

Ordering data

Type	Number of grommet positions		Qty	Order No.
	small	large		
HDC KEL 16/2	-	2	10	1825860000
HDC KEL 16/4	4	-*)	10	1825900000
HDC KEL 16/5	4	1	10	1849770000
HDC KEL 16/8	8	-	10	1825910000
Snap frame				
HDC KEL 16 SNAP			10	1827770000

*) with closed half shell

Dimensions

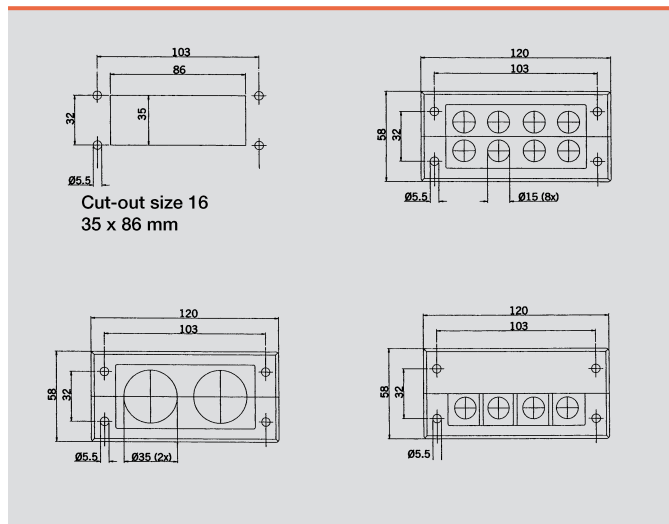

HDC KEL 24

Size equivalent to 24-pole HE inserts

KEL 24/10 with 10 small grommets



KEL 24/7 with 1 large and 6 small grommets



Snap frame
KEL 24 SNAP



Technical data

Material	Polyamide, free from halogenes and silicone
Colour	black
Temperature range	-20°C ... 80°C
Class of protection	IP54, when the correct cable grommet is selected
UL94 flammability rating	V0

Ordering data

Typ	Number of grommet positions		Qty	Order No.
	small	large		
HDC KEL 24/4	2	2	10	1825930000
HDC KEL 24/5	5	-*)	10	1825940000
HDC KEL 24/7	6	1	10	1849760000
HDC KEL 24/10	10	-	10	1827760000
Snap frame				
HDC KEL 24 SNAP			10	1827780000

*) with closed half shell

Dimensions

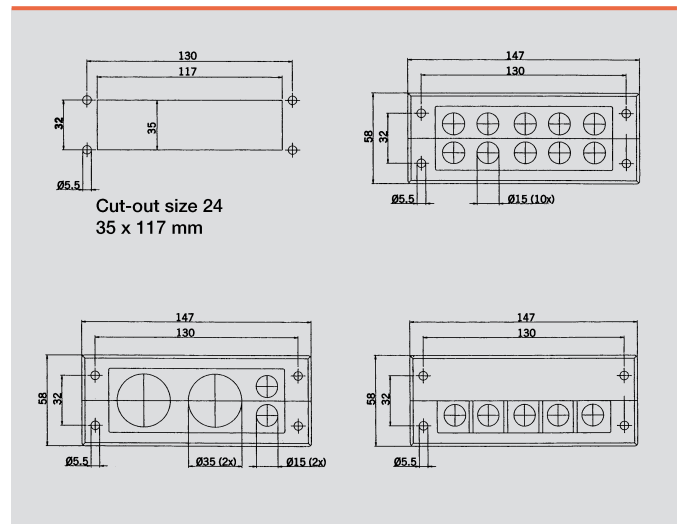

Cabtite – Cable entry frames

Cable clamping rail Cabtite KEL-EMV

Feeds through prefabricated cables without interrupting the shielding

Advantages:

- Direct, simple and quick contact with the enclosure
- Two-tier version saves space with up to 10 cables
- Strain relief without cable ties in accordance with VDE 0619
- No EMC cable glands necessary for mains-generated interference sources
- Low-impedance shielding contact
- Seals using outer sheath and not the shield = higher class of protection!
- Trouble-free retrofitting



H

Technical data

Material	Stainless steel
----------	-----------------

Ordering data

Type	for	Qty	Order No.
HDC KEL EMV 16/4	KEL 16	10	1825750000
HDC KEL EMV 24/5	KEL 24	10	1825760000
HDC KEL EMV x/3	KEL 16 and KEL 24 transverse	10	1825770000

Cabtite KVT

KVTs are used to feed through prefabricated cables when space is tight or only a few cables are required. As is the case with its big brother, the KEL, this product is also a two-piece system for easy assembly using the same cable grommets. The preassembled KVT 32 can be used for hole diameters up to 35 mm, the KVT 63 for hole diameters up to 65 mm. A sealing ring is also included.

- This two-piece system means that the size of the plug-in connector to be fed through is limited only by the size of the hole diameter.
- Two-piece two-tier system
- Fast and easy mounting
- The predefined gap achieves a minimum class of protection of IP54
- Large numbers of cables in very confined spaces
- Retrofitting of prefabricated wiring also possible
- The manufacturer's guarantee covering the prefabricated cables remains valid
- Integral strain relief to VDE 0619



KVT 32

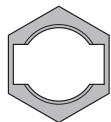

Locknut for D-Sub 9
KGM-SUB-D9



KVT 63-1

Technical data

Material	Polyamide, free from halogens and silicone
Class of protection	IP54, when the correct cable grommet is selected
Temperature range	-5°C ... 70°C
UL94 flammability rating	V0

Ordering data

Type	Thread	For grommet		Qty	Order No. white	Order No. black
		small	large			
HDC KVT 25	M 25 x 1.5	1	-	10	1826660000	1828260000
HDC KVT 32	M 32 x 1.5	1	-	10	1826670000	1828270000
HDC KVT 63-4	M 63 x 1.5	4	-	5	1828230000	1828280000
HDC KVT 63-1	M 63 x 1.5	-	1	5	1828240000	1828290000
Note: HDC KVT 63-x types are supplied with a locknut.						
Locknut for D-Sub 9						
KGM-SUB-D9	M 32 x 1.5			10	1828250000	1828300000

Operating mode

1. The grommet is fitted around the cable.

Important:

Choose an appropriately sized grommet for the diameter of the cable!



2. Press the grommet with the cable into the open cable gland. The flat sides of the grommet must face upwards when fitting the KVT 63/4!

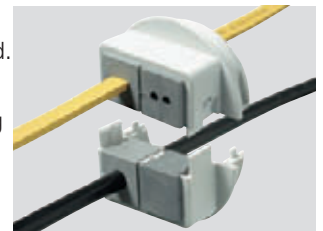

3. Squeeze the two halves of the cable gland together until they lock together with an audible "click".

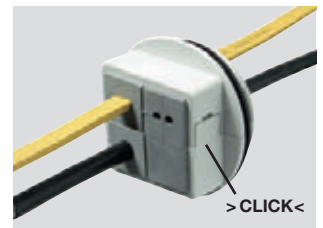

4. Place the seal, which is also supplied, over the thread. Then fit the cable gland into the hole and, if necessary, secure it with a locknut.

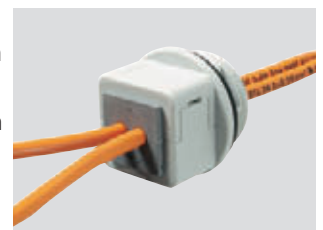

Weidmüller Service

Weidmüller Service	Bespoke services: best advice, best solutions	V.2
	Overview of services	V.3
	Digital support: RailDesigner®, M-Print® PRO, Online catalogue	V.5

Best advice, best solutions

Services tailored to customers' needs

Service – at Weidmüller that means diversity. And it also means that you can take advantage of our comprehensive resources:

- Production of terminal rails and enclosures fitted with our modular terminals and other modules, and prewired
- Fitting of cable glands and the marking of terminals, conductors and enclosures according to your specification
- Competence in the processing of enclosure materials such as aluminium, plastics, sheet steel and stainless steel
- Flexibility in the product selection: besides Weidmüller products we can also integrate yours and even those of other manufacturers

This range of services enables Weidmüller to act as an external service provider to increase your capacities. And demanding standards guarantee a high level of quality every time.

The best advice for the best solutions

The start of a good partnership is always characterised by an intensive exchange of information to define the respective positions. Our contribution focuses on detailed advice with respect to:

- Optimum choice of products
- Practical pre-assembly
- Integration into your systems
- Consideration of requirements such as certification, classes of protection or hazard protection as required by your industry

That avoids mistakes right from the start – totally in keeping with the effective handling of the project, totally in keeping with perfect results. Our experience helps you create the foundation for good business and satisfied customers.



Overview of services



Production of terminal rails

Terminal rails are manufactured from steel, stainless steel, aluminium or copper to suit the diverse applications. And we can produce terminal rails with elongated or round holes, or in other forms to suit your requirements exactly. Terminal rails are fitted with modular terminals or electronic products, prewired and marked according to your specification.

The benefits for you

- No need to procure individual components
- No need to mount individual components
- No unnecessary stocks
- Just one order number for your pre-assembled terminal rail
- Constant high quality



Production of enclosures

High-tech brings benefits. Our state-of-the-art production methods open up new options for you:

- Inclusion of holes and threads in the enclosure
- Enclosure cover with hinges and other accessories if required
- More complex machining such as milling of contours or reaming of holes
- Special paint finishes: To protect against the effects of the weather, your enclosures can be painted individually. Simply specify the colour and printing you require. Special paint finishes and powder coating are also possible.

Enclosures are adapted to suit the intended application exactly. You get a tailored, individual product and the quality is guaranteed by our adherence to demanding standards.



The benefits for you

- Enclosures in various sizes and materials
- Inclusion of optional accessories such as hinges and locks
- Complex machining processes and special packaging

Cable ducts and individual accessories

In some electrical installations cable ducts can be used to improve clarity and operating safety. If required, we can integrate such cable ducts for individual switchgear such as contactors, automatic devices or control equipment. That guarantees better clarity.

The benefits for you

- Large range of different cable entries
- Enhanced flexibility thanks to the ordering of products ready to connect
- Space-, time- and cost-saving installation thanks to the Cabtite cable entry system

Overview of services



Heavy-duty connectors

To help ensure that your switchgear cabinets and installations are put into operation without delay, Weidmüller can supply prefabricated components such as heavy-duty connectors. These are assembled and prewired according to your specification and are supplied ready to connect. If required, we can also supply the finished enclosure with the heavy-duty connectors already integrated. The ConCept heavy-duty connector system from Weidmüller renders possible a whole series of applications. This modular system enables the flexible combination with different modules, crimping and cabling – all-inclusive if required.

The benefits for you

- Special requirements with respect to font, number of characters, material and printing durability for your markers
- Prewiring of connectors saves you valuable installation time
- Modular connector system can be ordered pre-crimped

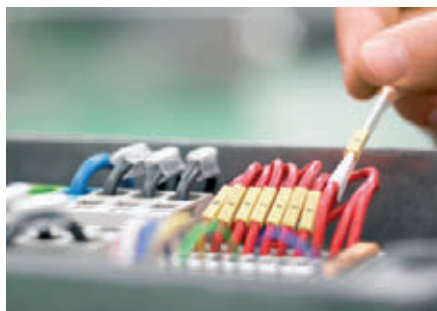

Marking

Whether multi-line labelling, white or coloured terminal markers or group designations, the Weidmüller range can cater for every marking task – fast, clear and according to European standards. However, we can also supply you with preprinted markers to match your specification. Simply tell us the type of marker you require, the colour, the printing sequence and the text, and we'll look after the rest. If required, we can also install the finished markers during assembly.



Equipment labelling

Device markers are essential for marking your electrical installations. Therefore, Weidmüller can supply rating plates designed specially for your application. A wide range of different shapes, colours, materials and fixings – riveted, screwed or bonded with adhesive – are available from which to choose. And a whole range of different fonts mean that we can handle every request.

Integration of special accessories

In some cases it is necessary to integrate special accessories. This is no problem for Weidmüller because we can integrate buttons, switches, warning lamps, plugs or couplings – all properly planned, fitted, connected and tested. And that includes the products of other manufacturers as well as our own. We shall also be happy to advise you on standard accessories such as hinges.

The benefits for you

- Rating plates in various materials
- Individual printing or laser engraving
- Equipment and accessories to your specification

Digital support

RailDesigner®

RailDesigner® is a Weidmüller program for planning, assembling and ordering both terminal rails and enclosures. And it's so easy to use:

- Fast acquisition of all necessary data
- Realistic-looking graphic user interface and ideal conditions for simple assembly of your terminal rails and enclosures with all the necessary components
- Simply click on all the products you need and add accessories such as markers or cross-connectors
- To configure an individual enclosure, simply choose an enclosure type from a standard range and then add holes and other accessories to suit your requirements

These parameters form the foundation for a perfect software assistant. You can view the enclosure on the screen complete with all the configured products, and print out a hardcopy, or simply send the file to Weidmüller via e-mail in the form of an order. RailDesigner® provides you with optimum planning security and clarity during the design phase. And hence simplifies the ordering process enormously.

M-Print® PRO label designer

The comprehensive range of Weidmüller services includes the M-Print® PRO software.

This is a professional-standard, Windows®-based program for printing and ordering labels and markers that is coordinated with our current printing systems and marking materials.

M-Print® PRO enables you to design your labelling materials professionally and quickly. Texts, borders, lines, graphics, bar-codes, serial numbers and photographs are all possible. The interface to RailDesigner® or your CAE system enables the transfer of all your configured data.

Online catalogue

If you have questions about the specifications and details of our products, perhaps even outside normal business hours, then our online catalogue at <http://catalog.weidmueller.com> – open 24 hours a day, 365 days a year – is the perfect source of information. Besides product features and part numbers, it contains extensive additional information on all product groups. And for further information, offers and your personal contact, simply consult the Weidmüller website at www.weidmueller.com.



Index

Index	Index Type / Index Order No.	X.2
	Worldwide activities	X.14

Type	Order No.	EAN No.	Page
A			
ABD-1-Stahlblech	9457300000	4032248173853	G.13
ABD-2-GR	1664330000	4008190421021	G.13
ABD-3-GR	1664350000	4008190421045	G.13
ABD-5-GR	1664390000	4008190421069	G.13
ABD-6-GR	1664390000	4008190421083	G.13
ABD-8-GR	1664970000	4008190421670	G.13
ABD-8-OR	1664960000	4008190421663	G.13
ABST.BOLZ.M3X27+KLSC-KI	1766130000	4008190081140	C.32
ADP-8/3-GR	1664990000	4008190421694	G.13
ADP-8/3-OR	1664980000	4008190421687	G.13
ADP-8/4-GR	1665010000	4008190421717	G.13
ADP-8/4-OR	1665000000	4008190421700	G.13
ADP-8/6-GR	1665030000	4008190421731	G.13
ADP-8/6-OR	1665020000	4008190421724	G.13
ADS/10-1/25	1666220000	4008190423261	G.13
ADS/10-2/25	1666230000	4008190423278	G.13
ADS/16-1/25	1666320000	4008190423377	G.13
ADS/16-1/37	1666340000	4008190423391	G.13
ADS/16-1/50	1666460000	4008190423375	G.13
ADS/16-2/25	1666330000	4008190423384	G.13
ADS/16-2/37	1666350000	4008190423407	G.13
ADS/6-1/15	1666200000	4008190423247	G.13
ADS/6-1/9	1665940000	4008190422974	G.13
ADS/6-2/15	1666210000	4008190423254	G.13
ADS/6-2/9	1665950000	4008190422981	G.13
AM LWL/POF	9020360000	4032248300556	G.11
AM LWL/POF	9020360000	4032248300556	G.7

Type	Order No.	EAN No.	Page
C			
Cabltite ATG	1828190000	4032248333707	H.15
Cabltite ATG black	1828220000	4032248333738	H.15
Cabltite BTG	1828180000	4032248333691	H.15
Cabltite BTK	1828170000	4032248333684	H.15
Cabltite KEL 16/2	1825900000	4032248328611	H.17
Cabltite KEL 16/4 EMC	1825750000	4032248328444	H.18
Cabltite KEL 16/5	1849770000	4032248378388	H.17
Cabltite KEL 16/8	1825910000	4032248328628	H.17
Cabltite KEL 24/10	1827760000	4032248333080	H.17
Cabltite KEL 24/4	1825930000	4032248328642	H.17
Cabltite KEL 24/5	1825940000	4032248328659	H.17
Cabltite KEL 24/5 EMC	1825760000	4032248328451	H.18
Cabltite KEL 24/7	1849760000	4032248378371	H.17
Cabltite KEL SNAP 16	1827770000	4032248333097	H.17
Cabltite KEL SNAP 24	1827780000	4032248333103	H.17
Cabltite KEL x/3 EMC	1825770000	4032248328468	H.18
Cabltite KT 10	1826530000	4032248329359	H.15
Cabltite KT 10 b	1827870000	4032248333189	H.15
Cabltite KT 11	1826540000	4032248329366	H.15
Cabltite KT 11 b	1827880000	4032248333196	H.15
Cabltite KT 12	1826550000	4032248329373	H.15
Cabltite KT 12 b	1827890000	4032248333202	H.15
Cabltite KT 13	1826560000	4032248329380	H.15
Cabltite KT 13 b	1827900000	4032248333417	H.15
Cabltite KT 14	1826570000	4032248329397	H.15
Cabltite KT 14 b	1827910000	4032248333424	H.15
Cabltite KT 15	1826580000	4032248329403	H.15
Cabltite KT 15 b	1827920000	4032248333431	H.15
Cabltite KT 16	1825950000	4032248328666	H.15
Cabltite KT 16 b	1827950000	4032248333462	H.15
Cabltite KT 17	1826300000	4032248329120	H.15
Cabltite KT 17 b	1827960000	4032248333479	H.15
Cabltite KT 18	1826310000	4032248329137	H.15
Cabltite KT 18 b	1827970000	4032248333486	H.15
Cabltite KT 19	1826320000	4032248329144	H.15
Cabltite KT 19 b	1827980000	4032248333493	H.15
Cabltite KT 2/4	1826620000	4032248329441	H.15
Cabltite KT 2/4 b	1828130000	4032248333664	H.15
Cabltite KT 2/5	1826630000	4032248329458	H.15
Cabltite KT 2/5 b	1828140000	4032248333653	H.15
Cabltite KT 2/6	1826640000	4032248329465	H.15
Cabltite KT 2/6 b	1828150000	4032248333660	H.15
Cabltite KT 20	1826330000	4032248329151	H.15
Cabltite KT 20 b	1827990000	4032248333509	H.15
Cabltite KT 21	1826340000	4032248329168	H.15
Cabltite KT 21 b	1828000000	4032248333516	H.15
Cabltite KT 22	1826350000	4032248329175	H.15
Cabltite KT 22 b	1828010000	4032248333523	H.15
Cabltite KT 23	1826360000	4032248329182	H.15
Cabltite KT 23 b	1828020000	4032248333530	H.15
Cabltite KT 24	1826370000	4032248329199	H.15
Cabltite KT 24 b	1828030000	4032248333547	H.15
Cabltite KT 25	1826380000	4032248329205	H.15
Cabltite KT 25 b	1828040000	4032248333554	H.15
Cabltite KT 26	1826390000	4032248329212	H.15
Cabltite KT 26 b	1828050000	4032248333561	H.15
Cabltite KT 27	1826400000	4032248329229	H.15
Cabltite KT 27 b	1828060000	4032248333578	H.15
Cabltite KT 28	1826410000	4032248329236	H.15
Cabltite KT 28 b	1828070000	4032248333585	H.15
Cabltite KT 29	1826420000	4032248329243	H.15
Cabltite KT 29 b	1828080000	4032248333592	H.15
Cabltite KT 3	1826430000	4032248329281	H.15
Cabltite KT 3 b	1827790000	4032248333318	H.15
Cabltite KT 30	1826430000	4032248329250	H.15
Cabltite KT 30 b	1828090000	4032248333608	H.15

Type	Order No.	EAN No.	Page
Cabltite KT 32	1826440000	4032248329267	H.15
Cabltite KT 32 b	1828100000	4032248333615	H.15
Cabltite KT 34	1826450000	4032248329274	H.15
Cabltite KT 34 b	1828110000	4032248333622	H.15
Cabltite KT 4	1826470000	4032248329298	H.15
Cabltite KT 4 b	1827800000	4032248333325	H.15
Cabltite KT 4/5	1826650000	4032248329472	H.15
Cabltite KT 4/5 b	1828160000	4032248333677	H.15
Cabltite KT 5	1826480000	4032248329304	H.15
Cabltite KT 5 b	1827810000	4032248333332	H.15
Cabltite KT 6	1826490000	4032248329311	H.15
Cabltite KT 6 b	1827830000	4032248333141	H.15
Cabltite KT 7	1826500000	4032248329328	H.15
Cabltite KT 7 b	1827840000	4032248333158	H.15
Cabltite KT 8	1826510000	4032248329335	H.15
Cabltite KT 8 b	1827850000	4032248333165	H.15
Cabltite KT 9	1826520000	4032248329342	H.15
Cabltite KT 9 b	1827860000	4032248333172	H.15
Cabltite KT ASI	1826610000	4032248329434	H.15
Cabltite KT ASI b	1828120000	4032248333639	H.15
Cabltite KT BTG b	1828210000	4032248333721	H.15
Cabltite KT BTK b	1828200000	4032248333714	H.15
Cabltite KTs 16	1826590000	4032248329410	H.15
Cabltite KTs 16 b	1827930000	4032248333448	H.15
Cabltite KTs 17	1826600000	4032248329427	H.15
Cabltite KTs 17 b	1827940000	4032248333455	H.15
Cabltite KVT 25	1826660000	4032248329489	H.19
Cabltite KVT 25 b	1828260000	4032248333776	H.19
Cabltite KVT 32	1826670000	4032248329496	H.19
Cabltite KVT 32 b	1828270000	4032248333783	H.19
Cabltite KVT 63/1	1828240000	4032248333752	H.19
Cabltite KVT 63/1 b	1828290000	4032248333806	H.19
Cabltite KVT 63/4	1828230000	4032248333745	H.19
Cabltite KVT 63/4 b	1828280000	4032248333790	H.19
Cabltite Sample Kit	1849780000	4032248378395	H.14
Cabltite SUBD9	1828250000	4032248333769	H.19
Cabltite SUBD9 b	1828300000	4032248333813	H.19
CTX CM 1.6/2.5	9018490000	4008190884598	G.3
CTX CM 1.6/2.5	9018490000	4008190884598	G.4
CTX CM 1.6/2.5	9018490000	4008190884598	G.5
CTX CM 3.6	9018480000	4008190884581	G.10
CTX CM 3.6	9018480000	4008190884581	G.4
CZB 1	9012710000	4008190118761	G.3
CZB 1	9012710000	4008190118761	G.3

D

Type	Order No.	EAN No.	Page
DSTV COBU5	1471500000	4008190178543	G.12
DSTV COST4	1471300000	4008190017354	G.12
DSTV HE BL10 S	1848570000	4032248371686	B.114
DSTV HE BL10 ZF	1837400000	4032248346561	B.114
DSTV HE BL16 S	1848580000	4032248371693	B.116
DSTV HE BL16 ZF	1837410000	4032248346578	B.116
DSTV HE BL24 S	1848590000	4032248371709	B.118
DSTV HE BL24 ZF	1837420000	4032248346585	B.118
DSTV HE BL6 S	1848550000	4032248371679	B.112
DSTV HE BL6 ZF	1837390000	4032248346554	B.112
DSTV HE BR10 S	1848610000	4032248371921	B.114
DSTV HE BR10 ZF	1837440000	4032248346608	B.114
DSTV HE BR16 S	1848620000	4032248371938	B.116
DSTV HE BR16 ZF	1837450000	4032248346613	B.116
DSTV HE BR24 S	1848630000	4032248371945	B.118
DSTV HE BR24 ZF	1837460000	4032248346620	B.118
DSTV HE BR6 S	1848600000	4032248371914	B.112
DSTV HE BR6 ZF	1837430000	4032248346592	B.112
DSTV HE SL10 S	1848680000	4032248371969	B.114
DSTV HE SL10 ZF	1837480000	4032248346644	B.114
DSTV HE SL16 S	1848700000	4032248371976	B.116
DSTV HE SL16 ZF	1837490000	4032248346651	B.116
DSTV HE SL24 S	1848730000	4032248371983	B.118
DSTV HE SL24 ZF	1837500000	4032248346668	B.118
DSTV HE SL6 S	1848660000	4032248371952	B.112
DSTV HE SL6 ZF	1837470000	4032248346637	B.112
DSTV HE SR10 S	1848750000	4032248372003	B.114
DSTV HE SR10 ZF	1837520000	4032248346682	B.114
DSTV HE SR16 S	1848760000	4032248372010	B.116
DSTV HE SR16 ZF	1837530000	4032248346699	B.116
DSTV HE SR24 S	1848770000	4032248372027	B.118
DSTV HE SR24 ZF	1837540000	4032248346690	B.118
DSTV HE SR6 S	1848740000	4032248371990	B.112
DSTV HE SR6 ZF	1837510000	4032248346675	B.112
DSTV TS 10-24 VH	1595240000	4008190057596	G.14
DSTV TS 6-24	1595220000	4008190013226	G.14
DSTV-HD-BL 16 SN	1566730000	4008190076030	B.122
DSTV-HD-BL 24 AU	1566420000	4008190059132	B.124
DSTV-HD-BL 24 SN	1566740000	4008190143213	B.124
DSTV-HD-BL 40 AU	1566430000	4008190186128	B.126
DSTV-HD-BL 40 SN	1566750000	4008190171810	B.126
DSTV-HD-BL 64 AU	1566440000	4008190050726	B.128
DSTV-HD-BL 64 SN	1566760000	4008190128906	B.128
DSTV-HD-BR 16 AU	1566330000	4008190066903	B.122
DSTV-HD-BR 16 SN	1566650000	4008190047528	B.122
DSTV-HD-BR 24 SN	1566680000	4008190178451	B.124
DSTV-HD-BR 40 AU	1566350		

Type	Order No.	EAN No.	Page	Type	Order No.	EAN No.	Page	Type	Order No.	EAN No.	Page
HDC 07A ALU	1652410000	4008190402488	D.5	HDC 16A SLU 2M20G	1788770000	4032248206315	D.19	HDC 24B TSBV 1PG21G	1661230000	4008190417789	D.30
HDC 07A AWLU	1652420000	4008190402471	D.5	HDC 16A SLU 2M25G	1788760000	4032248206308	D.19	HDC 24B TSBV 1PG29G	1661240000	4008190417796	D.30
HDC 07A DMDL 2BO	1665770000	4008190422790	D.5	HDC 16A SLU 2PG16G	1665070000	4008190421779	D.19	HDC 24B TSLU 1M25G	1787800000	4032248205240	D.32
HDC 07A DDDL 2BO	1665760000	4008190422783	D.5	HDC 16A TOLL 1M25G	1788750000	4032248206292	D.18	HDC 24B TSLU 1M32G	1787790000	4032248205233	D.32
HDC 07A ELU 1PG13G	1900990000	4032248592920	D.5	HDC 16A TOLL 1PG16G	1664810000	4008190421519	D.18	HDC 24B TSLU 1PG21G	1662390000	4008190418915	D.32
HDC 07A KOLU 1M20G	1788540000	4032248206070	D.5	HDC 16A TSLU 1M25G	1788740000	4032248206285	D.18	HDC 24B TSLU 1PG29G	1662410000	4008190418939	D.32
HDC 07A KOLU 1PG11G	1652460000	4008190402532	D.5	HDC 16A TSLU 1PG16G	1664690000	4008190421397	D.18	HDC 24D KLU 1M25G	1787460000	4032248204809	D.15
HDC 07A SLU 1M20G	1788530000	4032248206063	D.5	HDC 16B ABO	1208600000	4008190881351	D.21	HDC 24D KLU 1M32G	1787450000	4032248204793	D.15
HDC 07A SLU 1PG11S	1665760000	4008190402518	D.5	HDC 16B ADDBO	1209200000	4008190871130	D.25	HDC 24D SBU 1M25G	1903210000	4032248592999	D.13
HDC 07A TOLL 1M20G	1788520000	4032248206056	D.4	HDC 16B ADLU	1210100000	4008190050924	D.23	HDC 24D SBU 1M32G	1903220000	4032248588183	D.13
HDC 07A TOLL 1PG11G	1652380000	4008190402457	D.4	HDC 16B ALU	1209700000	4008190000134	D.23	HDC 24D SBU 1PG29G	1654470000	4008190407292	D.13
HDC 07A TWLU 1M20G	1788510000	4032248206049	D.4	HDC 16B DMDQ 2QB	1665270000	4008190421977	D.20	HDC 24D SBU 2M25G	1787350000	4032248204694	D.13
HDC 07A TWLU 1PG11G	1652400000	4008190402495	D.4	HDC 16B DMDQ 4BO	1665620000	4008190422646	D.24	HDC 24D SBU 2M32G	1787360000	4032248204700	D.13
HDC 10A ADLU	1664060000	4008190420758	D.9	HDC 16B DODQ 4BO	1665260000	4008190421960	D.21	HDC 24D SBU 2PG21G	1654450000	4008190407278	D.13
HDC 10A ALU	1664040000	4008190420734	D.9	HDC 16B KBU 1PG21G	1657270000	4032490410322	D.21	HDC 24D SDBO 1M25G	1903370000	4032248588190	D.16
HDC 10A DMDL 2BO	1665890000	4008190422912	D.9	HDC 16B KLU 1M25G	1788290000	4032248205820	D.23	HDC 24D SDBO 2M25G	1787400000	4032248204748	D.16
HDC 10A DDDL 1LB	1665890000	4008190422929	D.8	HDC 16B SBU 1M25G	1899980000	4032248520718	D.21	HDC 24D SDBO 1M25G	1903410000	4032248588206	D.15
HDC 10A KLU 1/PG16G	1664560000	4008190421250	D.9	HDC 16B SBU 1PG21G	1656720000	4008190409739	D.21	HDC 24D SDBO 1M32G	1903510000	4032248588213	D.15
HDC 10A KLU 1M25G	1788670000	4032248206216	D.9	HDC 16B SBU 2M25G	1788240000	4008190421397	D.21	HDC 24D SDBO 2M25G	1787420000	4032248204762	D.15
HDC 10A SDBO 1M20G	1901010000	4032248586155	D.9	HDC 16B SBU 2PG21G	1656730000	4008190409746	D.21	HDC 24D SDBO 2M32G	1787410000	4032248204755	D.15
HDC 10A SDBO 1M25G	1901040000	4032248586165	D.9	HDC 16B SDBO 1M25G	1900080000	4032248520756	D.25	HDC 24D SDBO 1M32G	1903560000	4032248588220	D.15
HDC 10A SDBO 1PG16G	1664410000	4008190421106	D.9	HDC 16B SDBO 2M25G	1788260000	4032248205790	D.25	HDC 24D SDBO 2M32G	1787370000	4032248204717	D.15
HDC 10A SDBO 2M20G	1788660000	4032248206209	D.9	HDC 16B SDBO 2PG21G	1657640000	4008190410698	D.25	HDC 24D TOBO 1PG29G	1654920000	4008190407926	D.16
HDC 10A SDBO 2M25G	1788650000	4032248206193	D.9	HDC 16B SDBO 1PG21G	1658320000	4008190411374	D.23	HDC 24D TOBO 1M25G	1787300000	4032248204649	D.12
HDC 10A SDBO 2PG16G	1664420000	4008190421113	D.9	HDC 16B SDBO 2M25G	1788270000	4032248205806	D.23	HDC 24D TOBO 1M32G	1787290000	4032248204632	D.12
HDC 10A SDBO 1M20G	1901100000	4032248586172	D.9	HDC 16B SDBO 2PG21G	1658330000	4008190421381	D.23	HDC 24D TOBO 1PG29G	1654320000	4008190407148	D.12
HDC 10A SDBO 1M25G	1901160000	4032248586186	D.9	HDC 16B SDBO 1M25G	1900170000	4032248520800	D.23	HDC 24D TOLL 1M25G	1787340000	4032248204687	D.14
HDC 10A SDBO 1PG16G	1664170000	4008190420894	D.9	HDC 16B SDBO 1PG21G	1658110000	4008190411169	D.23	HDC 24D TOLL 1M32G	1787330000	4032248204670	D.14
HDC 10A SDBO 1PG21G	1664210000	4008190420901	D.9	HDC 16B SDBO 2M25G	1788250000	4032248205783	D.23	HDC 24D TOLL 1PG21G	1655360000	4008190408367	D.14
HDC 10A SDBO 2M20G	1788640000	4032248206186	D.9	HDC 16B SDBO 2PG21G	1658120000	4008190411176	D.23	HDC 24D TOLL 1PG29G	1655380000	4008190408381	D.14
HDC 10A SDBO 2M25G	1788630000	4032248206179	D.9	HDC 16B TOBO 1M25G	1788220000	4032248205752	D.24	HDC 24D TSBV 1M25G	1787260000	4032248204681	D.16
HDC 10A SDBO 2PG16G	1664190000	4008190420888	D.9	HDC 16B TOBO 1PG21G	1657490000	4008190410544	D.24	HDC 24D TSBV 1M32G	1787250000	4032248204595	D.16
HDC 10A TOLL 1M20G	1788620000	4032248206162	D.8	HDC 16B TOBO 1M25G	1788210000	4032248205745	D.20	HDC 24D TSBV 1PG16G	1654810000	4008190407810	D.16
HDC 10A TOLL 1M25G	1788610000	4032248206155	D.8	HDC 16B TOBO 1PG21G	1656590000	4008190409609	D.20	HDC 24D TSBV 1PG21G	1654790000	4008190407797	D.16
HDC 10A TOLL 1PG16G	1663930000	4008190420628	D.8	HDC 16B TOLL 1M25G	1788230000	4032248205769	D.22	HDC 24D TSBV 1M25G	1787240000	4032248204588	D.12
HDC 10A TOLL 1PG21G	1663810000	4008190420505	D.8	HDC 16B TOLL 1M32G	1804630000	4032248267552	D.22	HDC 24D TSBV 1M32G	1787230000	4032248204571	D.12
HDC 10B ABO	1205000000	4008190872960	D.13	HDC 16B TOLL 1PG21G	1657980000	4008190411015	D.22	HDC 24D TSBV 1PG21G	1654150000	4008190406974	D.12
HDC 10B ADBO	1205600000	4008190153649	D.16	HDC 16B TSBV 1M25G	1788190000	4032248205721	D.24	HDC 24D TSBV 1PG29G	1654170000	4008190406998	D.12
HDC 10B ADLU	1206500000	4008190877484	D.15	HDC 16B TSBV 1PG21G	1657380000	4008190410438	D.24	HDC 24D TSLU 1M25G	1787280000	4032248204625	D.14
HDC 10B ALU	1206100000	4008190881344	D.15	HDC 16B TSBV 1M25G	1788180000	4032248205714	D.24	HDC 24D TSLU 1M32G	1787270000	4032248204618	D.14
HDC 10B DMDQ 2QB	1665240000	4008190421946	D.12	HDC 16B TSBV 1M40G	1809620000	4032248284979	D.20	HDC 24D TSLU 1PG21G	1655250000	4008190408251	D.14
HDC 10B DMDQ 4BO	1665250000	4008190421953	D.16	HDC 16B TSBV 1PG21G	1656480000	4008190409494	D.20	HDC 24D TSLU 1PG29G	1655270000	4008190408275	D.14
HDC 10B DDDQ 4BO	1665230000	4008190421939	D.13	HDC 16B TSBV 1M25G	1788200000	4032248205738	D.22	HDC 25A TOLL 1M20G	1788710000	4032248206254	D.18
HDC 10B KBU 1M20G	1787720000	4032248205066	D.13	HDC 16B TSBV 1M32G	1804640000	4032248267569	D.22	HDC 25A TOLL 1M25G	1788700000	4032248206247	D.18
HDC 10B KBU 1PG16G	1654580000	4008190407407	D.13	HDC 16B TSLU 1PG21G	1657850000	4008190410902	D.22	HDC 25A TOLL 1PG21G	1664870000	4008190421571	D.18
HDC 10B KLU 1M20G	1787740000	4032248205080	D.15	HDC 16D KLU 1/21V	1653230000	4008190403300	D.11	HDC 25A TOLL 1M20G	1788680000	4032248206223	D.18
HDC 10B KLU 1M25G	1787730000	4032248205073	D.15	HDC 16D SDBO 1M25G	1900820000	4032248521098	D.11	HDC 25A TSLU 1M25G	1788690000	4032248206230	D.18
HDC 10B KLU 1PG16G	1655890000	4008190408916	D.15	HDC 16D SDBO 2M25G	1787540000	4032248204885	D.11	HDC 25A TSLU 1PG16G	1664730000	4008190421434	D.18
HDC 10B SBU 1M20G	1901360000	4032248588237	D.13	HDC 16D SBU 1M25G	1900880000	4032248521111	D.11	HDC 25A TSLU 1PG21G	1664750000	4008190421458	D.18
HDC 10B SBU 1M25G	1901370000	4032248588244	D.13	HDC 16D SBU 1M32G	1900900000	4032248521128	D.11	HDC 32A ABO	1655860000	4008190871253	D.27
HDC 10B SBU 1PG16G	1654370000	4008190407193	D.13	HDC 16D SBU 2M25G	1787520000	4032248204861	D.11	HDC 32A DMDQ 2QB	1665930000	4008190422967	D.28
HDC 10B SBU 2M20G	1787640000	4032248204984	D.13	HDC 16D SBU 2M32G	1787510000	4032248204854	D.11	HDC 32A DODQ 4BO	1665920000	4008190422950	D.28
HDC 10B SBU 2M25G	1787630000	4032248204977	D.13	HDC 16D SDBO 2PG21G	1652840000	4008190402914	D.11	HDC 32A KBU 1M25G	1788080000	4032248205523	D.27
HDC 10B SBU 2PG16G	1654380000	4008190407209	D.13	HDC 16D TOLL 1M25G	1787500000	4032248204847	D.10	HDC 32A KBU 1M32G	1788070000	4032248205516	D.27
HDC 10B SDBO 1M20G	1901490000	4032248588251	D.16	HDC 16D TOLL 1M32G	1787490000	4032248204830	D.10	HDC 32A SBU 1M25G	1903870000	4032248586110	D.27
HDC 10B SDBO 1M25G	1901510000	4032248588268	D.16	HDC 16D TOLL 1PG21G	1652680000	4008190402754	D.10	HDC 32A SBU 1PG29G	1666010000	4008190423049	D.27
HDC 10B SDBO 2M20G	1787680000	4032248205028	D.16	HDC 16D TOLL 1PG29G	1652700000	4008190402778	D.10	HDC 32A SBU 2M25G	1788040000	4032248205486	D.27
HDC 10B SDBO 2M25G	1787670000	4032248205011	D.16	HDC 16D TSLU 1M25G	1787480000	4032248204823	D.10	HDC 32A SBU 2PG21G	1665980000	4008190423018	D.27
HDC 10B SDBO 2PG16G	1655600000	4008190408008	D.16	HDC 16D TSLU 1M32G	1787470000	4032248204816	D.10	HDC 32A SDBO 1M25G	1903900000	4032248586127	D.28
HDC 10B SDBO 1M20G	1901570000	4032248588275	D.15	HDC 16D TSLU 1PG21G	1652560000	4008190402831	D.10	HDC 32A SDBO 1M32G	1903910000	4032248586134	D.28
HDC 10B SDBO 2M20G	1787700000	4032248205042	D.15	HDC 16D TSLU 1PG29G	1652580000	4008190402855	D.10	HDC 32A SDBO 1PG21G	1666550000	4008190423674	D.28
HDC 10B SDBO 2PG16G	1655680000	4008190408701	D.15	HDC 24B ABO	1212400000	4008190083939	D.31	HDC 32A SDBO 1PG29G	1666590000	4008190423711	D.28
HDC 10B SLU 1M20G	1901620000	4032248587315	D.15	HDC 24B ADBO	1213300000	4008190871147	D.34	HDC 32A SDBO 2M25G	1788060000	4032248205509	D.28
HDC 10B SLU 1M25G	1901640000	4032248587322	D.15	HDC 24B ADLU	1214300000	4008190083090	D.33	HDC 32A SDBO 2M32G	1788050000	4032248205493	D.28
HDC 10B SLU 2M20G	1787660000	4032248205004	D.15	HDC 24B ALU	1213900000	4008190176303	D.33	HDC 32A TOBO 1M32G	1788010000	4032248205455	D.28
HDC 10B SLU 2M25G	1787650000	4032248204991	D.15	HDC 24B DMDQ 2QB	1665640000	4008190422860	D.30	HDC 32A TOBO 1M32G	1787990000	4032248205431	D.26
HDC 10B SLU 2PG16G	1655470000	4008190408480	D.15	HDC 24B DMDQ 4BO	1665650000	4008190422677	D.30	HDC 32A TOBU 1PG21G	1665790000	4008190422813	D.26
HDC 10B TOBO 1M25G	1787610000	4032248204953	D.16	HDC 24B DODQ 4BO	1665630000	4008190422853	D				

Type	Order No.	EAN No.	Page	Type	Order No.	EAN No.	Page	Type	Order No.	EAN No.	Page
HDC 32B TSLU 1PG29G	1667120000	4008190424329	D.40	HDC 64D TSBV 1M25G	1786780000	4032248204021	D.30	HDC HB 10 EMVK SS 2xM32	1827630000	4032248332830	E.14
HDC 32B TSLU 1PG29V	1219300000	4008190164652	D.40	HDC 64D TSBV 1M32G	1786770000	4032248204014	D.30	HDC HB 10 EMVK TOS			
HDC 40D KBU 1M25G	1787200000	4032248204540	D.21	HDC 64D TSBV 1PG21G	1661300000	4008190417857	D.30	1xM32	1827340000	4032248332441	E.14
HDC 40D KBU 1M25G	1787190000	4032248204533	D.21	HDC 64D TSBV 1PG29G	1661320000	4008190417871	D.30	HDC HB 10 EMVK TSS 1xM32	1827330000	4032248332434	E.14
HDC 40D KBU 1PG21G	1657310000	4008190410360	D.21	HDC 64D TSLU 1M32G	1786810000	4032248204052	D.32	HDC HB 10 IP68 AS M4	1827540000	4032248332649	E.6
HDC 40D KLU 1M25G	1787220000	4032248204564	D.23	HDC 64D TSLU 1M40G	1804610000	4032248267538	D.32	HDC HB 10 IP68 AS M6	1828580000	4032248334957	E.6
HDC 40D SBU 1M25G	1902970000	4032248592951	D.21	HDC 64D TSLU 1PG21G	1662470000	4008190418991	D.32	HDC HB 10 IP68 AS M6.D	1828530000	4032248334902	E.6
HDC 40D SBU 1M32G	1902990000	4032248592968	D.21	HDC 64D TSLU 1PG29G	1662490000	4008190419011	D.32	HDC HB 10 IP68 EMVK MD	1826740000	4032248330133	E.14
HDC 40D SBU 1PG29G	1656830000	4008190409845	D.21	HDC CM 10 FC	1758410000	4032248019632	C.7	HDC HB 10 IP68 EMVK MD	1826740000	4032248330133	E.6
HDC 40D SBU 2M25G	1787120000	4032248204465	D.21	HDC CM 10 FC MR	1862030000	4032248425464	C.7	HDC HB 10 IP68 SS 2xM32	1827640000	4032248332847	E.6
HDC 40D SBU 2M32G	1787110000	4032248204458	D.21	HDC CM 10 MC	1758400000	4032248019625	C.7	HDC HB 10 IP68 TOS 1xM32	1827360000	4032248332465	E.6
HDC 40D SBU 2PG21G	1656810000	4008190409821	D.21	HDC CM 10 MC MR	1862050000	4032248425488	C.7	HDC HB 10 IP68 TSS 1xM32	1827350000	4032248332458	E.6
HDC 40D SBU 2PG29G	1656840000	4008190409852	D.21	HDC CM 1BS +PE	1828410000	4032248334636	C.10	HDC HB 16 EMVK AS M4	1827510000	4032248332618	E.15
HDC 40D SBU 2PG29G	1903070000	4032248592975	D.23	HDC CM 1SS +PE	1828390000	4032248334612	C.10	HDC HB 16 EMVK AS M6	1828500000	4032248332482	E.15
HDC 40D SBU 2PG29G	1903080000	4032248592982	D.23	HDC CM 2BS	1828400000	4032248334629	C.10	HDC HB 16 EMVK SS 2xM32	1827610000	4032248332816	E.15
HDC 40D SBU 2PG29G	1656840000	4008190411459	D.23	HDC CM 2SS	1828380000	4032248334100	C.10	HDC HB 16 EMVK TOS			
HDC 40D SBU 2PG29G	1787180000	4032248204526	D.23	HDC CM 3 FC	1758370000	4032248019595	C.3	1xM32	1827280000	4032248332403	E.15
HDC 40D SBU 2PG29G	1787170000	4032248204519	D.23	HDC CM 3 FC MR	1879040000	4032248473564	C.3	HDC HB 16 EMVK TSS 1xM32	1827260000	4032248332397	E.15
HDC 40D SBU 2PG29G	1903110000	4032248590117	D.23	HDC CM 3 MC	1758360000	4032248019588	C.3	HDC HB 16 IP68 AS M4	1827520000	4032248332625	E.7
HDC 40D SBU 2PG29G	1804660000	4032248267606	D.23	HDC CM 3 MC MR	1879030000	4032248473567	C.3	HDC HB 16 IP68 AS M6	1828570000	4032248334940	E.7
HDC 40D SBU 2PG29G	1657550000	4008190410605	D.24	HDC CM 5 FC	1758390000	4032248019618	C.6	HDC HB 16 IP68 AS M6.D	1828510000	4032248334889	E.7
HDC 40D TOBU 1M25G	1787070000	4032248204410	D.20	HDC CM 5 FC MR	1879010000	4032248473533	C.6	HDC HB 16 IP68 EMVK MD	1826730000	4032248330126	E.15
HDC 40D TOBU 1M32G	1787060000	4032248204304	D.20	HDC CM 5 MC	1758380000	4032248019601	C.6	HDC HB 16 IP68 EMVK MD	1826730000	4032248330126	E.7
HDC 40D TOBU 1PG21G	1656630000	4008190409647	D.20	HDC CM 5 MC MR	1879020000	4032248473540	C.6	HDC HB 16 IP68 SS 2xM32	1827620000	4032248332823	E.7
HDC 40D TOBU 1PG29G	1656650000	4008190409661	D.20	HDC CM BUS 2BS T PBDD	1806030000	4032248275144	C.15	HDC HB 16 IP68 TOS 1xM32	1827310000	4032248332427	E.7
HDC 40D TOLL 1M32G	1787100000	4032248204441	D.22	HDC CM BUS 2SS PBDD	1806060000	4032248275182	C.15	HDC HB 16 IP68 TSS 1xM32	1827290000	4032248332410	E.7
HDC 40D TOLL 1PG29G	1658020000	4008190411077	D.22	HDC CM BUS 4BS	1814300000	4032248299379	C.14	HDC HB 24 EMVK AS M4	1827490000	4032248332595	E.16
HDC 40D TOLL 1PG29G	1787030000	4032248204274	D.24	HDC CM BUS 4SS	1814310000	4032248309320	C.14	HDC HB 24 EMVK AS M6	1828480000	4032248334858	E.16
HDC 40D TOLL 1PG29G	1787020000	4032248204267	D.24	HDC CM Bus F1 CT	1908540000		C.17	HDC HB 24 EMVK SS 2xM40	1827590000	4032248332694	E.16
HDC 40D TOLL 1PG29G	1657420000	4008190410476	D.24	HDC CM Bus F2	1908490000		C.16	HDC HB 24 EMVK TOS			
HDC 40D TOLL 1PG29G	1787010000	4032248204250	D.20	HDC CM Bus F4 CT	1908500000		C.17	1xM40	1827210000	4032248332359	E.16
HDC 40D TOLL 1PG29G	1787000000	4032248204243	D.20	HDC CM Bus GCA	1908510000		C.17	HDC HB 24 EMVK TSS 1xM40	1827220000	4032248332366	E.16
HDC 40D TOLL 1PG29G	1656520000	4008190409531	D.20	HDC CM Bus M1 CT	1908520000		C.17	HDC HB 24 IP68 AS M4	1827500000	4032248332601	E.8
HDC 40D TOLL 1PG29G	1656540000	4008190409555	D.20	HDC CM Bus M2	1908530000		C.16	HDC HB 24 IP68 AS M6	1828560000	4032248334933	E.8
HDC 40D TOLL 1PG29G	1787050000	4032248204298	D.22	HDC CM Bus M4 CT	1908480000		C.17	HDC HB 24 IP68 AS M6.D	1828490000	4032248334865	E.8
HDC 40D TOLL 1PG29G	1787040000	4032248204281	D.22	HDC CM HE 4 FC	1861900000	4032248425044	C.4	HDC HB 24 IP68 EMVK MD	1826720000	4032248330119	E.16
HDC 40D TOLL 1PG29G	1804650000	4032248267576	D.22	HDC CM HE 4 FC MR	1758350000	4032248019502	C.4	HDC HB 24 IP68 EMVK MD	1826720000	4032248330119	E.8
HDC 40D TOLL 1PG21G	1657890000	4008190410933	D.22	HDC CM HE 4 MC	1861920000	4032248425068	C.4	HDC HB 24 IP68 SS 2xM40	1827600000	4032248332700	E.8
HDC 40D TOLL 1PG29G	1657910000	4008190410964	D.22	HDC CM HE 4 MC MR	1758340000	4032248019496	C.4	HDC HB 24 IP68 TOS 1xM40	1827250000	4032248332380	E.8
HDC 48A ADLU	1666750000	4008190423865	D.37	HDC CM HV 3 FC	1862060000	4032248425495	C.9	HDC HB 24 IP68 TSS 1xM40	1827240000	4032248332373	E.8
HDC 48A ADLU	1666740000	4008190423858	D.37	HDC CM HV 3 FC MR	1862070000	4032248425501	C.9	HDC HB 24 TEK AS M4	1827470000	4032248332571	E.18
HDC 48A ADLU	1666810000	4008190423926	D.37	HDC CM HV 3 MC	1862080000	4032248425518	C.9	HDC HB 24 TEK AS M4	1846010000	4032248362127	E.18
HDC 48A ADLU	1666770000	4008190423889	D.37	HDC CM HV 3 MC MR	1862000000	4032248425433	C.9	HDC HB 24 TEK TOS 1xM50G	1827170000	4032248332328	E.18
HDC 48A ADLU	1788570000	4032248206100	D.37	HDC GRIP PANEL 8 SC	1934770000	4032248592029	G.17	HDC HB 24 TEK TSS 1xM50G	1827160000	4032248332311	E.18
HDC 48A ADLU	1788560000	4032248206094	D.36	HDC HA 10 FC	1873860000	4032248458370	B.8	HDC HB 24 TIP AS M4	1827480000	4032248332588	E.10
HDC 48A ADLU	1666730000	4008190423841	D.36	HDC HA 10 FS	1650620000	4008190299293	B.8	HDC HB 24 TIP AS M4	1846020000	4032248362141	E.10
HDC 48A ADLU	1788550000	4032248206087	D.36	HDC HA 10 FT	1896780000	4032248592388	B.8	HDC HB 24 TIP TOS 1xM50G	1827200000	4032248332342	E.10
HDC 48A ADLU	1666710000	4008190448127	D.36	HDC HA 10 MC	1873870000	4032248458387	B.8	HDC HB 24 TIP TSS 1xM50G	1827190000	4032248332335	E.10
HDC 48B ADLU	1222900000	4008190138004	D.43	HDC HA 10 MS	1650610000	4008190299286	B.8	HDC HB 24 TEK AS M4	1827450000	4032248332557	E.19
HDC 48B ADLU	1904150000	4032248585700	D.43	HDC HA 10 MT	1896790000	4032248592395	B.8	HDC HB 24 TEK AS M4	1845980000	4032248361991	E.19
HDC 48B ADLU	1799810000	4032248247035	D.43	HDC HA 16 FC	1873880000	4032248458394	B.10	HDC HB 24 TEK TOS 1xM50G	1827130000	4032248332281	E.19
HDC 48B ADLU	1788390000	4032248205929	D.43	HDC HA 16 FC	1873880000	4032248458394	B.10	HDC HB 24 TEK TSS 1xM40G	1827120000	4032248332274	E.19
HDC 48B ADLU	1667560000	4008190424763	D.43	HDC HA 16 FC	1873880000	4032248458394	B.14	HDC HB 24 TEK TVS 1xM50G	1853310000	4032248387380	E.19
HDC 48B ADLU	1904190000	4032248585779	D.43	HDC HA 16 FC 17-32	1876040000	4032248466375	B.12	HDC HB 24 TEK TVS 1xM50G	1827460000	4032248332564	E.11
HDC 48B ADLU	1651100000	4008190299705	D.43	HDC HA 16 FC 17-32	1876040000	4032248466375	B.14	HDC HB 24 TIP AS M4	1846000000	4032248362110	E.11
HDC 48B ADLU	1788370000	4032248205095	D.43	HDC HA 16 FC 33-48	1875540000	4032248465774	B.14	HDC HB 24 TIP TOS 1xM50G	1827150000	4032248332304	E.11
HDC 48B ADLU	1788360000	4032248205089	D.43	HDC HA 16 FS	1650780000	4008190299408	B.10	HDC HB 24 TIP TSS 1xM40G	1827140000	4032248332298	E.11
HDC 48B ADLU	1788350000	4032248205082	D.43	HDC HA 16 FS	1650780000	4008190299408	B.12	HDC HB 24 TIP TVS 1xM50G	1853300000	4032248387373	E.11
HDC 48B ADLU	1788330000	4032248205868	D.43	HDC HA 16 FS	1650780000	4008190299408	B.14	HDC HB 6 EMVK AS M4	1827550000	4032248332656	E.13
HDC 48B ADLU	1650980000	4008190299606	D.43	HDC HA 16 FS 17-32	1650900000	4008190299514	B.12	HDC HB 6 EMVK AS M6	1828540000	4032248334919	E.13
HDC 48B ADLU	1651000000	4008190299620	D.43	HDC HA 16 FS 17-32	1650900000	4008190299514	B.14	HDC HB 6 EMVK SS 2xM25	1827650000	4032248332854	E.13
HDC 48B ADLU	1788320000	4032248205851	D.43	HDC HA 16 FS 33-48	1651020000	4008190299644	B.14	HDC HB 6 EMVK TOS 1xM25	1827380000	4032248332489	E.13
HDC 48B ADLU	1788310000	4032248205844	D.43	HDC HA 16 FT	1896800000	4032248592401	B.10	HDC HB 6 EMVK TSS 1xM25	1827370000	4032248332472	E.13
HDC 48B ADLU	1788300000	4032248205837	D.43	HDC HA 16 FT	1896800000	4032248592401	B.12	HDC HB 6 IP68 AS M4	1827560000	4032248332663	E.5
HDC 48B ADLU	1650850000	4008190299453	D.43	HDC HA 16 FT	1896800000	4032248592401	B.14	HDC HB 6 IP68 AS M6	1828590000	4032248334964	E.5
HDC 48B ADLU	1650860000	4008190299460	D.43	HDC HA 16 FT 17-32	1896810000	4032248592418	B.12	HDC HB 6 IP68 AS M6.D	1828550000	4032248334926	E.5
HDC 48B ADLU	1670470000	4008190431556	D.43	HDC HA 16 FT 17-32	1896810000	4032248592418	B.14	HDC HB 6 IP68 EMVK MD	1826750000	4032248330140	E.13
HDC 64D KBU 1M32G	1786960000	4032248204205	D.31	HDC HA 16 FT 33-48	1896820000	4032248592425	B.14	HDC HB 6 IP68 EMVK MD	1826750000	4032248330140	E.5
HDC 64D KBU 1PG29G	1661810000	4008190418359	D.31	HDC HA 16 MC	1873890000	4032248458400	B.10	HDC HB 6 IP68 SS 2xM25	1827660000	4032248332861	E.5
HDC 64D KBU 1M25G	1904340000	4032248585601	D.31	HDC HA 16 MC	1873890000	4032248458400	B.12	HDC HB 6 IP68 TOS 1xM25	1827400000	4032248332502	E.5
HDC 64D SBU 1M32G	1904350000	4032248585298	D.31	HDC HA 16 MC	1873890000	4032248458400	B.14	HDC HB 6 IP68 TSS 1xM25	1827390000	4032248332496	E.5
HDC 64D SBU 2M25G	1786890000	4032248204137	D.31	HDC HA 16 MC 17-32	1875620000	4032248465927	B.12	HDC HB10 AWLW	1		

Type	Order No.	EAN No.	Page	Type	Order No.	EAN No.	Page	Type	Order No.	EAN No.	Page
HDC HDD 216 FC	1651300000	4008190299903	B.76	HDC HVE 6+2 FS	1651340000	4008190299941	B.82	HDC-CM-1BPN4.0	1894720000	4032248509195	C.11
HDC HDD 216 MC	1651280000	4008190299880	B.76	HDC HVE 6+2 FT	1896940000	4032248602131	B.82	HDC-CM-1SPN2.5	1894730000	4032248509201	C.11
HDC HDD 24 FC	1651160000	4008190299767	B.66	HDC HVE 6+2 MS	1651330000	4008190299934	B.82	HDC-CM-1SPN4.0	1894740000	4032248509218	C.11
HDC HDD 24 MC	1651150000	4008190299750	B.66	HDC HVE 6+2 MT	1896950000	4032248602148	B.82	HDC-CM-20/CZC9428P	1700900000	4008190900151	C.8
HDC HDD 42 FC	1651180000	4008190299787	B.68	HDC Kit HA 04.402 M	1802700000	4032248257324	F.6	HDC-CM-20/CZC9428P	1700900000	4008190900151	G.10
HDC HDD 42 MC	1651170000	4008190299774	B.68	HDC Kit HA 04.406 M	1802720000	4032248257331	F.6	HDC-CM-20/CZC9428P	1700900000	4008190900151	G.5
HDC HDD 72 FC	1651200000	4008190299804	B.70	HDC Kit HE 06.100 M	1802730000	4032248257348	F.8	HDC-CM-20B3G GR	1758430000	4032248019656	C.8
HDC HDD 72 FC	1651200000	4008190299804	B.74	HDC Kit HE 06.101 M	1802740000	4032248257355	F.8	HDC-C-M20-BCG0.08-0.2AU	1682430000	4008190859954	G.5
HDC HDD 72 MC	1651190000	4008190299798	B.70	HDC Kit HE 06.101 M	1797580000	4032248239252	G.9	HDC-C-M20-BCG0.2-0.52AU	1682450000	4008190859961	G.5
HDC HDD 72 MC	1651190000	4008190299798	B.74	HDC RailMate COS 1 Set	1798280000	4032248241866	G.9	HDC-CM-20SCG GR	1758420000	4032248019649	C.8
HDC HE 10 FC	1204400000	4008190062899	B.20	HDC RailMate HB 10 Set	1797510000	4032248239184	G.9	HDC-C-M20-SCG0.08-0.2AU	1682420000	4008190859930	G.5
HDC HE 10 FP	1873540000	4032248458158	B.20	HDC RailMate HB10 Top	1797550000	4032248239221	G.9	HDC-C-M20-SCG0.2-0.52AU	1682440000	4008190859947	G.5
HDC HE 10 FS	1204100000	4008190117172	B.20	HDC RailMate HB16 Set	1797520000	4032248239191	G.9	HDC-CM-2BPN2.5	1894750000	4032248509223	C.11
HDC HE 10 FT	1745770000	4008190985493	B.20	HDC RailMate HB16 Top	1797560000	4032248239238	G.9	HDC-CM-2BPN4.0	1894760000	4032248509225	C.11
HDC HE 10 MC	1204300000	4008190068318	B.20	HDC RailMate HB24 Set	1797530000	4032248239207	G.9	HDC-CM-2SPN2.5	1894770000	4032248509249	C.11
HDC HE 10 MP	1873550000	4032248458165	B.20	HDC RailMate HB24 Top	1797570000	4032248239245	G.9	HDC-CM-2SPN4.0	1894710000	4032248509188	C.11
HDC HE 10 MS	1203930000	4008190169916	B.20	HDC RailMate HB6 Set	1797500000	4032248239177	G.9	HDC-CM-3/CZTB0002	1700890000	4008190900144	G.10
HDC HE 10 MT	1745830000	4008190985554	B.20	HDC RailMate HB6 Top	1797540000	4032248239214	G.9	HDC-CM-3/CZTB0002	1700890000	4008190900144	G.4
HDC HE 16 FC	1208000000	4008190015978	B.22	HDC S4 0 BAS	1789970000	4032248212033	B.98	HDC-C-M3-BM1.5AG	1698130000	4008190885045	G.4
HDC HE 16 FC	1208000000	4008190015978	B.26	HDC S4 0 SAS	1789960000	4032248212026	B.98	HDC-C-M3-BM10.0AG	1682310000	4008190474041	G.4
HDC HE 16 FC 17-32	1216700000	4008190073091	B.26	HDC S4 0 SAS	1789980000	4032248212040	B.96	HDC-C-M3-BM2.5AG	1698150000	4008190885052	G.4
HDC HE 16 FP	1873560000	4032248458172	B.22	HDC S4 SAS	1789990000	4032248212057	B.96	HDC-C-M3-BM4.0AG	1682270000	4008190474003	G.4
HDC HE 16 FP	1873560000	4032248458172	B.26	HDC S6 12 BAS	1790010000	4032248212071	B.100	HDC-C-M3-BM6.0AG	1682290000	4008190474207	G.4
HDC HE 16 FP 17-32	1875740000	4032248466023	B.26	HDC S6 12 SAS	1790000000	4032248212064	B.100	HDC-C-M3-SM1.5AG	1698120000	4008190885038	G.4
HDC HE 16 FS	1207700000	4008190136383	B.22	HDC S6 6 BAS	1790020000	4032248212088	B.102	HDC-C-M3-SM10.0AG	1682330000	4008190474034	G.4
HDC HE 16 FS	1207700000	4008190136383	B.26	HDC S6 6 SAS	1790030000	4032248212095	B.102	HDC-C-M3-SM2.5AG	1698140000	4008190885052	G.4
HDC HE 16 FS 17-32	1216100000	4008190055259	B.26	HDC SHIELD CLAMP 10.0	1912250000	4032248541577	G.16	HDC-C-M3-SM4.0AG	1682260000	4008190473990	G.4
HDC HE 16 FT	1216780000	4008190985595	B.22	HDC SHIELD CLAMP 4.5	1912190000	4032248541515	G.16	HDC-C-M3-SM2.0AG	1682280000	4008190470110	G.4
HDC HE 16 FT	1745780000	4008190985509	B.26	HDC SHIELD CLAMP 5.0	1912200000	4032248541522	G.16	HDC-CM-4BZF AG	1730130000	4008190384685	C.5
HDC HE 16 FT 17-32	1745800000	4008190985523	B.26	HDC SHIELD CLAMP 6.0	1912210000	4032248541539	G.16	HDC-CM-4SZF AG	1730120000	4008190384678	C.5
HDC HE 16 MC	1207900000	4008190171698	B.22	HDC SHIELD CLAMP 7.0	1912220000	4032248541546	G.16	HDC-C-M5-BM0.75-1.0AG	1682350000	4008190474089	G.4
HDC HE 16 MC	1207900000	4008190171698	B.26	HDC SHIELD CLAMP 8.0	1912230000	4032248541553	G.16	HDC-C-M5-BM1.5AG	1682370000	4008190474102	G.4
HDC HE 16 MC 17-32	1216500000	4008190048089	B.26	HDC SHIELD CLAMP 9.0	1912240000	4032248541560	G.16	HDC-C-M5-BM2.5AG	1682390000	4008190474126	G.4
HDC HE 16 MP	1873570000	4032248458189	B.22	HDC SHIELD LEVER 3 SC	1867390000	4032248438372	G.15	HDC-C-M5-BM4.0AG	1682410000	4008190474140	G.4
HDC HE 16 MP	1873570000	4032248458189	B.26	HDC SHIELD LEVER 4 SC	1867370000	4032248438358	G.15	HDC-C-M5-SM0.75-1.0AG	1682340000	4008190474072	G.4
HDC HE 16 MP 17-32	1875800000	4032248466061	B.26	HDC SHIELD LEVER 6 SC	1867380000	4032248438365	G.15	HDC-C-M5-SM1.5AG	1682360000	4008190474096	G.4
HDC HE 16 MS	1207500000	4008190154790	B.22	HDC SHIELD LEVER 8 SC	1867360000	4032248438341	G.15	HDC-C-M5-SM2.5AG	1682380000	4008190474119	G.4
HDC HE 16 MS	1207500000	4008190154790	B.26	HDC-C-HD-B-LWL1.0POF	1773640000	4032248142743	G.6	HDC-C-M5-SM4.0AG	1682400000	4008190474133	G.4
HDC HE 16 MS 17-32	1215700000	4008190056360	B.26	HDC-C-HD-BM0.14-0.37AG	1651570000	4008190400248	G.3	HDC-CR10-3B GR	1758470000	4032248019694	C.20
HDC HE 16 MT	1745840000	4008190985561	B.22	HDC-C-HD-BM0.14-0.37AG	1651570000	4008190400248	G.5	HDC-CR10-3S GR	1758460000	4032248019687	C.20
HDC HE 16 MT	1745840000	4008190985561	B.26	HDC-C-HD-BM0.14-0.37AU	1651670000	4008190400347	G.3	HDC-CR16-5B GR	1758490000	4032248019717	C.22
HDC HE 16 MT 17-32	1745860000	4008190985585	B.26	HDC-C-HD-BM0.14-0.37AU	1651670000	4008190400347	G.5	HDC-CR16-5B-2 GR	1758530000	4032248019755	C.26
HDC HE 24 FC	1211600000	4008190033200	B.24	HDC-C-HD-BM0.5AG	1651580000	4008190400255	G.3	HDC-CR16-5S GR	1758480000	4032248019700	C.22
HDC HE 24 FC	1211600000	4008190033200	B.28	HDC-C-HD-BM0.5AG	1651580000	4008190400255	G.5	HDC-CR16-5S-2 GR	1758520000	4032248019748	C.26
HDC HE 24 FC 25-48	1226600000	4008190165567	B.28	HDC-C-HD-BM0.5AU	1651680000	4008190400354	G.3	HDC-CR24-7B GR	1758510000	4032248019731	C.24
HDC HE 24 FC	1873580000	4032248458196	B.24	HDC-C-HD-BM0.5AU	1651680000	4008190400354	G.5	HDC-CR24-7B-2 GR	1758550000	4032248019729	C.28
HDC HE 24 FP	1873580000	4032248458196	B.28	HDC-C-HD-BM0.75-1.00AG	1601760000	4008190158354	G.3	HDC-CR24-7S GR	1758500000	4032248019774	C.24
HDC HE 24 FP 25-48	1875850000	4032248466115	B.28	HDC-C-HD-BM0.75-1.00AG	1601760000	4008190158354	G.5	HDC-CR24-7S-2 GR	1758540000	4032248019762	C.28
HDC HE 24 FS	1211300000	4008190067298	B.24	HDC-C-HD-BM0.75-1.00AU	1651690000	4008190400361	G.3	HDC-CR6-2B GR	1758450000	4032248019670	C.18
HDC HE 24 FS	1211300000	4008190067298	B.28	HDC-C-HD-BM0.75-1.00AU	1651690000	4008190400361	G.5	HDC-CR6-2S GR	1758440000	4032248019663	C.18
HDC HE 24 FS 25-48	1221200000	4008190014896	B.28	HDC-C-HD-BM1.5AG	1651600000	4008190400279	G.3	HDC-DW-MOD	1688200000	4008190857189	G.11
HDC HE 24 FT	1745790000	4008190985516	B.24	HDC-C-HD-BM1.5AG	1651600000	4008190400279	G.5	HDC-HA10FD	1739200000	4008190955182	G.14
HDC HE 24 FT	1745790000	4008190985516	B.28	HDC-C-HD-BM1.5AU	1651700000	4008190400378	G.3	HDC-HA16FD	1739190000	4008190955175	G.14
HDC HE 24 FT 25-48	1745810000	4008190985530	B.28	HDC-C-HD-BM1.5AU	1651700000	4008190400378	G.5	HDC-HA32FD	1739210000	4008190955199	G.14
HDC HE 24 MC	1211500000	4008190042097	B.24	HDC-C-HD-BM2.5AG	1651610000	4008190400286	G.3	HDC-HA3FD	1739220000	4008190955205	G.14
HDC HE 24 MC	1211500000	4008190042097	B.28	HDC-C-HD-BM2.5AG	1651610000	4008190400286	G.5	HDC-HA48 FD	1855950000	4032248398713	G.14
HDC HE 24 MC 25-48	1226400000	4008190061104	B.28	HDC-C-HD-BM2.5AU	1651710000	4008190400385	G.3	HDC-HB10 AWVL FD	1855680000	4032248397617	G.14
HDC HE 24 MP	1873590000	4032248458202	B.24	HDC-C-HD-BM2.5AU	1651710000	4008190400385	G.5	HDC-HB10 FD	1855970000	4032248398737	G.14
HDC HE 24 MP	1873590000	4032248458202	B.28	HDC-C-HD-S-LWL1.0POF	1773630000	4032248142736	G.6	HDC-HB10-AVU	1205000000	4008190872960	B.115
HDC HE 24 MP 25-48	1875890000	4032248466153	B.28	HDC-C-HD-SM0.14-0.37AG	1651520000	4008190400194	G.3	HDC-HB16 FD	1855980000	4032248398744	G.14
HDC HE 24 MS	1211100000	4008190181703	B.24	HDC-C-HD-SM0.14-0.37AG	1651520000	4008190400194	G.5	HDC-HB16-AVU	1208600000	4008190881351	B.117
HDC HE 24 MS	1211100000	4008190181703	B.28	HDC-C-HD-SM0.14-0.37AU	1651620000	4008190400293	G.3	HDC-HB24 FD	1855990000	4032248398751	G.14
HDC HE 24 MS 25-48	1220800000	4008190168896	B.28	HDC-C-HD-SM0.14-0.37AU	1651620000	4008190400293	G.5	HDC-HB24-AVU	1212400000	4008190083939	B.119
HDC HE 24 MT	1745850000	4008190985578	B.24	HDC-C-HD-SM0.5AG	1651530000	4008190400200	G.3	HDC-HB32 FD	1856000000	4032248398768	G.14
HDC HE 24 MT	1745850000	4008190985578	B.28	HDC-C-HD-SM0.5AG	1651530000	4008190400200	G.5	HDC-HB48 FD	1856010000	4032248398775	G.14
HDC HE 24 MT 25-48	1745870000	4008190985592	B.28	HDC-C-HD-SM0.5AU	1651630000	4008190400309	G.3	HDC-HB6 FD	1855960000	4032248398720	G.14
HDC HE 6 FC	1201000000	4008190131678	B.18	HDC-C-HD-SM0.5AU	1651630000	4008190400309	G.5	HDC-HB6-ADVL	1202500000	4008190889920	B.113
HDC HE 6 FP	1873520000	4032248457779	B.18	HDC-C-HD-SM0.75-1.00AG	1601750000	4008190134280	G.3	HDC-HB6-AVL	1202100000	4008190149369	B.113
HDC HE 6 FS	1202000000	4008190140021	B.18	HDC-C-HD-SM0.75-1.00AG	1601750000	4008190134280	G.5	HDC-KIT-HA 03.300	1712560000	4008190947781	F.5
HDC HE 6 FT	1745760000	4008190985486	B.18	HDC-C-HD-SM0.75-1.00AU	1651640000	4008190400316	G.3	HDC-KIT-HA 03.300 M	1802470000	4032248356945	F.4
HDC HE 6 MC	1200400000	4008190110864	B.18	HDC-C-HD-SM0.75-1.00AU	1651640000	4008190400316	G.5	HDC-KIT-HA 03.301	1712570000	4008190947798	F.5
HDC HE 6 MP	1873530000	4032248457786	B.18	HDC-C-HD-SM1.5AG	1651550000	4008190400224	G.3	HDC-KIT-HA 03.301 M	1802460000	4032248256921	F.4
HDC HE 6 MS											

Type	Order No.	EAN No.	Page	Type	Order No.	EAN No.	Page	Type	Order No.	EAN No.	Page
HDC-KIT-HE 32.140 M	1802370000	4032248256822	F.16	VG 13,5-K68 SKS	1720500000	4008190358716	H.7	VG M40-EXE SW	1737320000	4008190956790	H.10
HDC-KIT-HE 48.150	1712550000	4008190947774	F.19	VG 13,5-MS54	0260800000	4008190163716	H.8	VG M40-EXI BL	1737390000	4008190956868	H.10
HDC-KIT-HE 48.150 M	1802360000	4032248256815	F.18	VG 13,5-MS54-ZE	1718830000	4008190352059	H.9	VG M40-K67	1909730000	4032248536658	H.6
HDC-KIT-HSB 06.500	1724000000	4008190367770	F.20	VG 13,5-MS68	1569090000	4008190177089	H.9	VG M50-1/K68	1909900000	4032248536825	H.6
HTX-HDC/POF	9010950000	4032248331543	G.11	VG 16-EXE MS	1719030000	4008190352257	H.11	VG M50-1/MS68	1909950000	4032248536870	H.9
HTX-HDC/POF	9010950000	4032248331543	G.7	VG 16-EXE SW	1490800000	4008190044824	H.10	VG M50-EXE MS	1737260000	4008190956738	H.11
K				VG 16-EXI BL	1491600000	4008190188580	H.10	VG M50-EXE SW	1737330000	4008190956806	H.10
KT 8	9002650000	4008190020163	G.7	VG 16-K68	1569010000	4008190004460	H.6	VG M50-EXI BL	1737400000	4008190956882	H.10
KV 11-M	1656390000	4008190409401	H.8	VG 16-K68 SKS	1720510000	4008190358723	H.7	VG M50-K67	1909740000	4032248536665	H.6
KV 13-M	1656400000	4008190409418	H.8	VG 16-MS54	0261400000	4008190118624	H.8	VG M63 - K 68	1772350000	4032248130016	H.6
KV 16-M	1656410000	4008190409425	H.8	VG 16-MS54-ZE	1718840000	4008190352066	H.9	VG M63 - MS 68	1772270000	4032248129288	H.9
KV 21-M	1656420000	4008190409432	H.8	VG 16-MS68	1569100000	4008190051969	H.9	VG M63-EXE MS	1737270000	4008190956745	H.11
KV 29-M	1656430000	4008190409449	H.8	VG 21-EXE MS	1719040000	4008190352264	H.11	VG M63-EXI BL	1737340000	4008190956813	H.10
KV 42-M	1656450000	4008190409463	H.8	VG 21-EXE SW	1490900000	4008190108779	H.10	VG M63-EXI BL	1737410000	4008190956905	H.10
L				VG 21-EXI BL	1491700000	4008190187453	H.10	VG M63-K67	1909750000	4032248536672	H.6
LM MT300 20X8 GE	1686381687	4008190493943	G.9	VG 21-K68	1569020000	4008190032234	H.6	VG PG11-K67	1909780000	4032248536702	H.6
LM MT300 20X8 SI	1686380001	4008190493929	G.9	VG 21-K68 SKS	1720520000	4008190358730	H.7	VG PG13,5-K67	1909790000	4032248536719	H.6
LM MT300 20X8 WS	1686381044	4008190493936	G.9	VG 21-MS54	0260900000	4008190120528	H.8	VG PG16-K67	1909800000	4032248536726	H.6
M				VG 21-MS54-ZE	1718850000	4008190352073	H.9	VG PG21-K67	1909810000	4032248536733	H.6
MODUFLEX C-CR	1746060000	4008190986476	C.32	VG 21-MS68	1569110000	4008190168469	H.9	VG PG29-K67	1909820000	4032248536740	H.6
MODUFLEX C-KITO.M.MW-1F	1765570000	4032248059805	C.33	VG 29-EXE MS	1719050000	4008190352271	H.11	VG PG36-K67	1909830000	4032248536757	H.6
MODUFLEX C-KITO.M.MW-2F	1765580000	4032248059799	C.33	VG 29-EXE SW	1491000000	4008190048808	H.10	VG PG42-K67	1909840000	4032248536764	H.6
MODUFLEX C-KITO.M.MW-3F	1765590000	4032248059812	C.33	VG 29-EXI BL	1491800000	4008190150150	H.10	VG PG48-K67	1909850000	4032248536771	H.6
MODUFLEX C-KITO.M.MW-4F	1765600000	4032248059829	C.33	VG 29-K68	1569030000	4008190142872	H.6	VG PG7-K67	1909760000	4032248536689	H.6
MODUFLEX C-KITO.M.MW-5F	1765610000	4032248059836	C.33	VG 29-MS54	0261000000	4008190088378	H.8	VG PG9-K67	1909770000	4032248536696	H.6
MODUFLEX C-MH/ZE	1752970000	4032248190614	C.33	VG 29-MS54-ZE	1718860000	4008190352080	H.9	VGM12-K68 SKS	1776700000	4032248156122	H.7
MODUFLEX C-MW	1746070000	4008190986483	C.32	VG 29-MS68	1569120000	4008190176419	H.9	VGM12-MS54 KB 5,0-7,0	1778410000	4032248161416	H.8
MOFU 35	0495660000	4008190048518	C.32	VG 36-EXE MS	1719060000	4008190352288	H.11	VGM12-MS54 ZE 5,0-7,0	1778420000	4032248161409	H.8
P				VG 36-EXE SW	1491100000	4008190139728	H.10	VGM12-MS54 ZE 5,0-7,0	1778430000	4032248161430	H.9
PB LWL/POF	9020400000	4032248300587	G.11	VG 36-EXI BL	1491900000	4008190002893	H.10	VGM16-K68 SKS	1776710000	4032248156139	H.7
PB LWL/POF	9020400000	4032248300587	G.7	VG 36-K68	1569040000	4008190024833	H.6	VGM16-MS54	1778390000	4032248161393	H.8
PS LWL/POF	9020390000	4032248300570	G.11	VG 42-MS54	0497600000	4008190153700	H.8	VGM16-MS54 ZE	1778440000	4032248161454	H.9
PS LWL/POF	9020390000	4032248300570	G.7	VG 42-MS54-ZE	1718870000	4008190352097	H.9	VGM20-K68 SKS 10,0-14,0	1776720000	40322481561146	H.7
PTSC KB 30X6 WN1412	1766120000	4008190078386	C.32	VG 42-EXE MS	1569130000	4008190148263	H.9	VGM20-K68 SKS 6,0-12,0	1778860000	4032248161374	H.7
R				VG 42-EXE SW	1719070000	4008190352295	H.11	VGM20-MS54 KB 10,0-12,0	1778370000	4032248161879	H.8
Removal Tool CM 20	1866740000	4032248437061	G.11	VG 42-EXI BL	1492000000	4008190145545	H.10	VGM20-MS54 KB 8,0-10,0	1778380000	4032248161386	H.8
Removal Tool CM 20	1866740000	4032248437061	G.5	VG 42-K68	1569050000	4008190178932	H.6	VGM20-MS54 ZE 6,0-11,5	1778450000	4032248161461	H.9
Removal Tool CM 3	1866710000	4032248437030	G.11	VG 42-MS54	0497700000	4008190056582	H.8	VGM20-MS54 ZE 6,0-8,0	1778460000	4032248161478	H.9
Removal Tool CM 3	1866710000	4032248437030	G.4	VG 48-MS54-ZE	1718880000	4008190352103	H.9	VGM25-K68 SKS	1776730000	4032248156135	H.7
Removal Tool CM 5	1866720000	4032248437047	G.11	VG 48-EXE MS	1569140000	4008190010515	H.9	VGM25-MS54 KB 12,0-14,0	1778360000	4032248161362	H.8
Removal Tool CM 5	1866720000	4032248437047	G.4	VG 48-EXE SW	1719080000	4008190352301	H.11	VGM25-MS54 KB 15,0-17,0	1778350000	4032248161355	H.8
Removal Tool HD	1866730000	4032248437054	G.11	VG 48-K68	1718970000	4008190352196	H.10	VGM25-MS54 ZE 9,0-21,5	1778480000	4032248161422	H.9
Removal Tool HD	1866730000	4032248437054	G.3	VG 48-MS54	1718980000	4008190352202	H.10	VGM32-MS54	1778340000	4032248161348	H.8
Removal Tool HD	1866730000	4032248437054	G.5	VG 48-MS54-ZE	1718770000	4008190351977	H.6	VGM32-MS54 ZE	1778490000	4032248161508	H.9
Removal Tool HD	1866730000	4032248437054	G.7	VG 48-MS68	1718780000	4008190351977	H.6	VGM40-MS54	1778330000	4032248161331	H.8
Removal Tool HE	1866750000	4032248437078	G.11	VG 48-MS68 SKS	1718780000	4008190352004	H.8	VGM40-MS54 ZE	1778500000	4032248161515	H.9
Removal Tool HE	1866750000	4032248437078	G.3	VG 48-MS54-ZE	1718890000	4008190352110	H.9	VGM50-MS54 KB 31,0-33,0	1778320000	4032248161324	H.8
S				VG 48-MS68	1718790000	4008190352011	H.9	VGM50-MS54 KB 39,0-41,0	1778310000	4032248161317	H.8
SF 10 BEZ. 0-9	0332400000	4008190105402	B.122	VG 7-EXE MS	1718900000	4008190352219	H.11	VGM50-MS54 ZE 29,0-42,5	1778520000	4032248161539	H.9
SF 10 BEZ. 1-10	0331500001	4008190055233	B.122	VG 7-EXE SW	1569360000	4008190011550	H.10	VGM63-MS54	1778300000	4032248161102	H.8
SF 10 BEZ. 11-20	0331500011	4008190060700	B.122	VG 7-EXI BL	1569370000	4008190068035	H.10	VGM63-MS54 ZE	1778530000	4032248161546	H.9
SG 10 BEZ. 0	0332501000	4008190093419	B.122	VG 7-K68	1569870000	4008190175580	H.6	VP 11-K54	0294860000	4008190147822	H.13
SG 10 BEZ. 1	0332500001	4008190158996	B.122	VG 7-K68 SKS	1720470000	4008190358686	H.7	VP 11-MS65	0294800000	4008190143947	H.13
SG 10 BEZ. 2	0332500002	4008190156374	B.122	VG 7-MS54	0521500000	4008190017828	H.8	VP 13,5-K54	0294960000	4008190152859	H.13
SG 10 BEZ. 3	0332500003	4008190117528	B.122	VG 7-MS54-ZE	1718800000	4008190352028	H.9	VP 13,5-MS65	0294900000	4008190053383	H.13
SG 10 BEZ. 4	0332500004	4008190076870	B.122	VG 7-MS68	1569060000	4008190107055	H.9	VP 16-K54	0295060000	4008190170479	H.13
SG 10 BEZ. 5	0332500005	4008190156060	B.122	VG 9-EXE MS	1719000000	4008190352226	H.11	VP 16-MS65	0295000000	400819001032	H.13
SG 10 BEZ. 6	0332500006	4008190007539	B.122	VG 9-EXE SW	1490500000	4008190024772	H.10	VP 21-K54	0295160000	4008190012007	H.13
SG 10 BEZ. 7	0332500007	4008190013189	B.122	VG 9-EXI BL	1491300000	4008190056898	H.10	VP 21-MS65	0295100000	4008190012859	H.13
SG 10 BEZ. 8	0332500008	4008190018337	B.122	VG 9-K68	1569890000	4008190136673	H.6	VP 29-K54	0501160000	4008190174361	H.13
SG 10 BEZ. 9	0332500009	4008190142131	B.122	VG 9-K68 SKS	1720480000	4008190358693	H.7	VP 29-MS65	0501100000	4008190126308	H.13
SO 10	0332300000	4008190012106	B.122	VG 9-MS54	0261500000	4008190155438	H.8	VP 36-K54	0501260000	4008190020972	H.13
SPB-M 3	1203600000	4008190120047	G.12	VG 9-MS54-ZE	1718810000	4008190352035	H.9	VP 36-MS65	0501200000	4008190103378	H.13
T				VG 9-MS68	1569070000	4008190116262	H.9	VP 42-K54	0501360000	4008190020293	H.13
THM MT30X 32/9 GE/M	1751771687	4032248001491	G.9	VG H M20 MS	1921720000	4032248562909	H.8	VP 42-MS65	0501300000	4008190007676	H.13
THM MT30X 32/9 SI/M	1751770001	4032248001507	G.9	VG H M25 MS	1921740000	4032248563012	H.8	VP 48-K54	1719280000	4008190352516	H.13
THM MT30X 32/9 WS/M	1751771044	4032248001484	G.9	VG H M32 MS	1921760000	4032248563029	H.8	VP 48-MS65	1719270000	4008190352523	H.13
V				VG H M40 MS	1921770000	4032248563036	H.8	VP 7-K54	1719250000	4008190352509	H.13
VG 11-EXE MS	1719010000	4008190352233	H.11	VG M12 - K 68	1772280000	4032248129935	H.6	VP 7-MS65	0521600000	4008190011871	H.13
VG 11-EXE SW	1490600000	4008190116422	H.10	VG M12 - MS 68	1772200000	4032248129850	H.9	VP 9-K54	0294760000	40081900105884	H.13
VG 11-EXI BL	1491400000	4008190092955	H.10	VG M12-K67	1909660000	4032248536580	H.6	VP 9-MS65	0294700000	4008190005887	H.13
VG 11-K68	1569990000	4008190178123	H.6	VG M16-1/K68	1909860000	4032248536788	H.6	VP M12 K54	1776930000	4032248156375	H.13
VG 11-K68 SKS	1720490000	4008190358709	H.7	VG M16-1/MS68	1909910000	4032248536832	H.9	VP M12-MS65	1777720000	4032248157990	H.13
VG 11-MS54	0260700000	4008190170523	H.8	VG M16-EXE MS	1737210000	4008190956684	H.11	VP M16 K54	1776920000	4032248156368	H.13
VG 11-MS54-ZE	1718820000	4008190352042	H.9	VG M16-EXE SW	1737280000	4008190956752	H.10	VP M16-MS65	1777730000	4032248158003	H.13
VG 11-MS68											

Order No.	EAN No.	Type	Page
026000000			
0260700000	4008190170523	VG 11-MS54	H.8
0260800000	4008190163716	VG 13,5-MS54	H.8
0260900000	4008190120528	VG 21-MS54	H.8
0261000000	4008190088378	VG 29-MS54	H.8
0261400000	4008190118624	VG 16-MS54	H.8
0261500000	4008190155438	VG 9-MS54	H.8

029000000

0294700000	4008190005887	VP 9-MS65	H.13
0294760000	4008190105884	VP 9-K54	H.13
0294800000	4008190143947	VP 11-MS65	H.13
0294860000	4008190147822	VP 11-K54	H.13
0294900000	4008190053383	VP 13,5-MS65	H.13
0294960000	4008190152659	VP 13,5-K54	H.13
0295000000	4008190001032	VP 16-MS65	H.13
0295060000	4008190170479	VP 16-K54	H.13
0295100000	4008190128593	VP 21-MS65	H.13
0295160000	4008190012007	VP 21-K54	H.13

033000000

0331500001	4008190055233	SF 10 BEZ. 1-10	B.122
0331500011	4008190067007	SF 10 BEZ. 11-20	B.122
0332300000	4008190012106	SO 10	B.122
0332400000	4008190105402	SF 10 BEZ. 0-9	B.122
0332500001	4008190158996	SG 10 BEZ. 1	B.122
0332500002	4008190156374	SG 10 BEZ. 2	B.122
0332500003	4008190117528	SG 10 BEZ. 3	B.122
0332500004	4008190076870	SG 10 BEZ. 4	B.122
0332500005	4008190156060	SG 10 BEZ. 5	B.122
0332500006	4008190007539	SG 10 BEZ. 6	B.122
0332500007	4008190013189	SG 10 BEZ. 7	B.122
0332500008	4008190018337	SG 10 BEZ. 8	B.122
0332500009	4008190142131	SG 10 BEZ. 9	B.122
0332501000	4008190093419	SG 10 BEZ. 0	B.122

049000000

0495660000	4008190048518	MOFU 35	C.32
0497600000	4008190153700	VG 36-MS54	H.8
0497700000	4008190056582	VG 42-MS54	H.8

050000000

0501100000	4008190126308	VP 29-MS65	H.13
0501160000	4008190174361	VP 29-K54	H.13
0501200000	4008190103378	VP 36-MS65	H.13
0501260000	4008190020972	VP 36-K54	H.13
0501300000	4008190007676	VP 42-MS65	H.13
0501360000	4008190020293	VP 42-K54	H.13

052000000

0521500000	4008190017828	VG 7-MS54	H.8
0521600000	4008190011871	VP 7-MS65	H.13

120000000

1200000000	4008190067564	HDC HE 6 MS	B.18
1200200000	4008190140021	HDC HE 6 FS	B.18
1200400000	4008190110864	HDC HE 6 MC	B.18
1200500000	4008190159627	HDC-C-HE-SM0.5AG	G.3
1200600000	4008190171308	HDC-C-HE-SM0.75-1.00AG	G.3
1200700000	4008190074920	HDC-C-HE-SM1.5AG	G.3
1200800000	4008190131913	HDC-C-HE-SM2.5AG	G.3
1200900000	4008190115906	HDC-C-HE-SM4.0AG	G.3
1201000000	4008190131678	HDC HE 6 FC	B.18
1201100000	4008190142698	HDC-C-HE-BM0.5AG	G.3
1201200000	4008190044480	HDC-C-HE-BM0.75-1.00AG	G.3
1201300000	4008190100346	HDC-C-HE-BM1.5AG	G.3
1201400000	4008190047078	HDC-C-HE-BM2.5AG	G.3
1201500000	4008190148096	HDC-C-HE-BM4.0AG	G.3
1202100000	4008190149369	HDC 06B ALU	D.11
1202100000	4008190149369	HDC-HB-6-AVL	B.113
1202500000	4008190889920	HDC 06B ADLU	D.11
1202500000	4008190889920	HDC-HB-6-ADVL	B.113
1203600000	4008190120047	SPB-M 3	G.12
1203900000	4008190169916	HDC HE 10 MS	B.20
1204100000	4008190170172	HDC HE 10 FS	B.20
1204300000	4008190068318	HDC HE 10 MC	B.20
1204400000	4008190062899	HDC HE 10 FC	B.20
1205000000	4008190872960	HDC 10B ABU	D.13
1205000000	4008190872960	HDC-HB-10-AVU	B.115
1205600000	4008190153649	HDC 10B ADBO	D.16
1206100000	40081900881344	HDC 10B ALU	D.15
1206500000	40081900877484	HDC 10B ADLU	D.15
1207500000	4008190154790	HDC HE 16 MS	B.22
1207500000	4008190154790	HDC HE 16 MS	B.26
1207700000	4008190136383	HDC HE 16 FS	B.22
1207700000	4008190136383	HDC HE 16 FS	B.26
1207900000	4008190171698	HDC HE 16 MC	B.22
1207900000	4008190171698	HDC HE 16 MC	B.26
1208000000	4008190015978	HDC HE 16 FC	B.22

1208000000	4008190015978	HDC HE 16 FC	B.26
1208600000	4008190081351	HDC 16B ABU	D.21
1208600000	4008190081351	HDC-HB-16-AVU	B.117
1209200000	4008190087130	HDC 16B ADBO	D.25
1209700000	4008190000134	HDC 16B ALU	D.23

121000000

1210100000	4008190050924	HDC 16B ADLU	D.23
1211100000	4008190181703	HDC HE 24 MS	B.24
1211100000	4008190181703	HDC HE 24 MS	B.28
1211300000	4008190067298	HDC HE 24 FS	B.24
1211300000	4008190067298	HDC HE 24 FS	B.28
1211500000	4008190042097	HDC HE 24 MC	B.24
1211500000	4008190042097	HDC HE 24 MC	B.28
1211600000	4008190033200	HDC HE 24 FC	B.24
1211600000	4008190033200	HDC HE 24 FC	B.28
1212400000	4008190083939	HDC 24B ABU	D.31
1212400000	4008190083939	HDC-HB-24-AVU	B.119
1213300000	4008190871147	HDC 24B ADBO	D.34
1213900000	4008190176303	HDC 24B ALU	D.33
1214300000	4008190083090	HDC 24B ADLU	D.33
1214500000	4008190153021	HDC 24B SDLU 2PG21G	D.33
1215700000	4008190056360	HDC HE 16 MS 17-32	B.26
1216100000	4008190055295	HDC HE 16 FS 17-32	B.26
1216500000	4008190040895	HDC HE 16 MC 17-32	B.26
1216700000	4008190073091	HDC HE 16 FC 17-32	B.26
1217300000	4008190169497	HDC 32B TOBU 1PG29V	D.38
1217800000	4008190148393	HDC 32B ABU	D.39
1218800000	4008190070557	HDC 32B ADBO	D.42
1219300000	4008190164652	HDC 32B TSLU 1PG29V	D.40
1219500000	4008190011826	HDC 32B ALU	D.41
1219800000	4008190111090	HDC 32B ADLU	D.41

122000000

1220800000	4008190168896	HDC HE 24 MS 25-48	B.28
1221200000	4008190014896	HDC HE 24 FS 25-48	B.28
1222900000	4008190138004	HDC 48B ADLU	D.43
1226400000	4008190061104	HDC HE 24 MC 25-48	B.28
1226600000	4008190165567	HDC HE 24 FC 25-48	B.28

147000000

1471300000	4008190017354	DSTV COST4	G.12
1471500000	4008190178543	DSTV COBU5	G.12

149000000

1490500000	4008190024772	VG 9-EXE SW	H.10
1490600000	4008190116422	VG 11-EXE SW	H.10
1490700000	4008190099213	VG 13,5-EXE SW	H.10
1490800000	4008190044824	VG 16-E-EXE SW	H.10
1490900000	4008190108779	VG 21-EXE SW	H.10
1491000000	4008190048808	VG 29-EXE SW	H.10
1491100000	4008190139728	VG 36-EXE SW	H.10
1491200000	4008190121563	VG 42-EXE SW	H.10
1491300000	4008190065898	VG 9-EXI BL	H.10
1491400000	4008190092955	VG 11-EXI BL	H.10
1491500000	4008190082024	VG 13,5-EXI BL	H.10
1491600000	4008190188580	VG 16-EXI BL	H.10
1491700000	4008190187453	VG 21-EXI BL	H.10
1491800000	4008190150150	VG 29-EXI BL	H.10
1491900000	4008190002893	VG 36-EXI BL	H.10
1492000000	4008190145545	VG 42-EXI BL	H.10
1497600000	4008190136406	HDC 04A ALU	D.7
1498100000	4008190048747	HDC HA 3 MS	B.4
1498200000	4008190176556	HDC HA 3 FS	B.6
1498300000	4008190006471	HDC HA 4 MS	B.4
1498400000	4008190178741	HDC HA 4 FS	B.6
1498700000	4008190035136	HDC HSB 6 MS	B.88
1498700000	4008190035136	HDC HSB 6 MS	B.90
1498800000	4008190071875	HDC HSB 6 MS 7 - 12	B.90
1498900000	4008190071417	HDC HSB 6 FS	B.88
1498900000	4008190071417	HDC HSB 6 FS	B.90
1499000000	4008190006082	HDC HSB 6 FS 7 - 12	B.90

156000000

1566330000	4008190066093	DSTV-HD-BR 16 AU	B.122
1566350000	4008190071103	DSTV-HD-BR 40 AU	B.126
1566360000	4008190119898	DSTV-HD-BR 64 AU	B.126
1566370000	4008190130404	DSTV-HD-SR 16 AU	B.122
1566390000	4008190089009	DSTV-HD-SR 40 AU	B.126
1566400000	4008190002282	DSTV-HD-SR 64 AU	B.128
1566420000	4008190059132	DSTV-HD-BL 24 AU	B.124
1566430000	4008190186128	DSTV-HD-BL 40 AU	B.126
1566440000	4008190050726	DSTV-HD-BL 64 AU	B.128
1566450000	4008190187187	DSTV-HD-SL 16 AU	B.122
1566470000	4008190088385	DSTV-HD-SL 40 AU	B.126
1566480000	4008190041878	DSTV-HD-SL 64 AU	B.128
1566500000	4008190047528	DSTV-HD-BR 16 SN	B.122
1566600000	4008190178451	DSTV-HD-BR 24 SN	B.124
1566670000	4008190046859	DSTV-HD-BR 40 SN	B.126
1566680000	4008190186845	DSTV-HD-BR 64 SN	B.128
1566700000	4008190130596	DSTV-HD-SR 24 SN	B.124
1566710000	4008190069995	DSTV-HD-SR 40 SN	B.126

1566720000	4008190092108	DSTV-HD-SR 64 SN	B.128
1566730000	4008190076030	DSTV-HD-BL 16 SN	B.122
1566740000	4008190143213	DSTV-HD-BL 24 SN	B.124
1566750000	4008190171810	DSTV-HD-BL 40 SN	B.126
1566760000	4008190128906	DSTV-HD-BL 64 SN	B.128
1566790000	4008190097853	DSTV-HD-SL 40 SN	B.126
1566800000	4008190103286	DSTV-HD-SL 64 SN	B.128
1568970000	4008190175580	VG 7-K68	H.6
1568980000	4008190136673	VG 9-K68	H.6
1568990000	4008190178123	VG 11-K68	H.6
1569000000	4008190094522	VG 13,5-K68	H.6
1569010000	4008190004460	VG 16-K68	

Order No.	EAN No.	Type	Page
1651300000	4008190299903	HDC HDD 216 FC	B.76
1651310000	4008190299910	HDC HVE 3+2 MS	B.80
1651320000	4008190299927	HDC HVE 3+2 FS	B.80
1651330000	4008190299934	HDC HVE 6+2 MS	B.82
1651340000	4008190299941	HDC HVE 6+2 FS	B.82
1651350000	4008190299958	HDC HVE 10+2 MS	B.84
1651360000	4008190299965	HDC HVE 10+2 FS	B.84
1651420000	4008190400095	HDC-C-HE-SM0.5AU	G.3
1651430000	4008190400101	HDC-C-HE-SM0.75-1.00AU	G.3
1651440000	4008190400118	HDC-C-HE-SM1.5AU	G.3
1651450000	4008190400125	HDC-C-HE-SM2.5AU	G.3
1651460000	4008190400132	HDC-C-HE-SM4.0AU	G.3
1651470000	4008190400149	HDC-C-HE-BM0.5AU	G.3
1651480000	4008190400156	HDC-C-HE-BM0.75-1.00AU	G.3
1651490000	4008190400163	HDC-C-HE-BM1.5AU	G.3
1651500000	4008190400170	HDC-C-HE-BM2.5AU	G.3
1651510000	4008190400187	HDC-C-HE-BM4.0AU	G.3
1651520000	4008190400194	HDC-C-HD-SM0.14-0.37AG	G.5
1651530000	4008190400200	HDC-C-HD-SM0.5AG	G.3
1651530000	4008190400200	HDC-C-HD-SM0.5AG	G.5
1651550000	4008190400224	HDC-C-HD-SM1.5AG	G.3
1651550000	4008190400224	HDC-C-HD-SM1.5AG	G.5
1651560000	4008190400231	HDC-C-HD-SM2.5AG	G.3
1651560000	4008190400231	HDC-C-HD-SM2.5AG	G.5
1651570000	4008190400248	HDC-C-HD-BM0.14-0.37AG	G.3
1651570000	4008190400248	HDC-C-HD-BM0.14-0.37AG	G.5
1651580000	4008190400255	HDC-C-HD-BM0.5AG	G.3
1651580000	4008190400255	HDC-C-HD-BM0.5AG	G.5
1651600000	4008190400279	HDC-C-HD-BM1.5AG	G.3
1651600000	4008190400279	HDC-C-HD-BM1.5AG	G.5
1651610000	4008190400286	HDC-C-HD-BM2.5AG	G.3
1651610000	4008190400286	HDC-C-HD-BM2.5AG	G.5
1651620000	4008190400293	HDC-C-HD-SM0.14-0.37AU	G.3
1651620000	4008190400293	HDC-C-HD-SM0.14-0.37AU	G.5
1651630000	4008190400309	HDC-C-HD-SM0.5AU	G.3
1651630000	4008190400309	HDC-C-HD-SM0.5AU	G.5
1651640000	4008190400316	HDC-C-HD-SM0.75-1.00AU	G.3
1651640000	4008190400316	HDC-C-HD-SM0.75-1.00AU	G.5
1651650000	4008190400323	HDC-C-HD-SM1.5AU	G.3
1651650000	4008190400323	HDC-C-HD-SM1.5AU	G.5
1651660000	4008190400330	HDC-C-HD-SM2.5AU	G.3
1651660000	4008190400330	HDC-C-HD-SM2.5AU	G.5
1651670000	4008190400347	HDC-C-HD-BM0.14-0.37AU	G.3
1651670000	4008190400347	HDC-C-HD-BM0.14-0.37AU	G.5
1651680000	4008190400354	HDC-C-HD-BM0.5AU	G.3
1651680000	4008190400354	HDC-C-HD-BM0.5AU	G.5
1651690000	4008190400361	HDC-C-HD-BM0.75-1.00AU	G.3
1651690000	4008190400361	HDC-C-HD-BM0.75-1.00AU	G.5
1651700000	4008190400378	HDC-C-HD-BM1.5AU	G.3
1651700000	4008190400378	HDC-C-HD-BM1.5AU	G.5
1651710000	4008190400385	HDC-C-HD-BM2.5AU	G.3
1651710000	4008190400385	HDC-C-HD-BM2.5AU	G.5
1652380000	4008190402457	HDC 07A TOLU 1PG11G	D.4
1652400000	4008190402495	HDC 07A TWLU 1PG11G	D.4
1652410000	4008190402488	HDC 07A ALU	D.5
1652420000	4008190402471	HDC 07A AWLU	D.5
1652440000	4008190402518	HDC 07A SLU 1PG11S	D.5
1652460000	4008190402532	HDC 07A KOLU 1PG11G	D.5
1652470000	4008190402549	HDC 04A TOLLU 1PG11G	D.6
1652480000	4008190402556	HDC 04A TWLU 1PG11G	D.6
1652490000	4008190402563	HDC 04A SLU 1PG11G	D.7
1652500000	4008190402570	HDC 04A KOLU 1PG11G	D.7
1652520000	4008190402594	HDC 06B TSLU 1PG16G	D.10
1652560000	4008190402631	HDC 16D TSLU 1PG21G	D.10
1652580000	4008190402655	HDC 16D TSLU 1PG29G	D.10
1652640000	4008190402716	HDC 06B TOLU 1PG16G	D.10
1652680000	4008190402754	HDC 16D TOLLU 1PG21G	D.10
1652700000	4008190402778	HDC 16D TOLU 1PG29G	D.10
1652750000	4008190402822	HDC 06B SLU 1PG16G	D.11
1652760000	4008190402839	HDC 06B SLU 2PG16G	D.11
1652840000	4008190402914	HDC 16D SLU 2PG21G	D.11
1652980000	4008190403058	HDC 06B SDLU 1PG16G	D.11
1652990000	4008190403065	HDC 06B SDLU 2PG16G	D.11
1653200000	4008190403270	HDC 06B KLU 1PG16G	D.11
1653230000	4008190403300	HDC 16D KLU 1/21V	D.11
1654070000	4008190406899	HDC 10B TBSBU 1PG16G	D.12
1654090000	4008190406912	HDC 10B TBSBU 1PG21G	D.12
1654150000	4008190406974	HDC 24D TBSBU 1PG21G	D.12
1654170000	4008190406998	HDC 24D TBSBU 1PG29G	D.12
1654220000	4008190407049	HDC 10B TOBU 1PG16G	D.12
1654240000	4008190407063	HDC 10B TOBU 1PG21G	D.12
1654320000	4008190407148	HDC 24D TOBU 1PG29G	D.12
1654370000	4008190407193	HDC 10B SBU 1PG16G	D.13
1654380000	4008190407209	HDC 10B SBU 2PG16G	D.13
1654450000	4008190407278	HDC 24D SBU 2PG21G	D.13
1654470000	4008190407292	HDC 24D SBU 1PG29G	D.13
1654580000	4008190407407	HDC 10B KBU 1PG16G	D.13
1654750000	4008190407759	HDC 10B TBSBU 1PG16G	D.16
1654790000	4008190407797	HDC 24D TBSBU 1PG21G	D.16
1654810000	4008190407810	HDC 24D TBSBU 1PG16G	D.16
1654860000	4008190407865	HDC 10B TOBU 1PG16G	D.16
1654920000	4008190407926	HDC 24D TOBU 1PG29G	D.16
1655000000	4008190408008	HDC 10B SDBO 2PG16G	D.16
1655210000	4008190408213	HDC 10B TSLU 1PG16G	D.14
1655250000	4008190408251	HDC 24D TSLU 1PG21G	D.14
1655270000	4008190408275	HDC 24D TSLU 1PG29G	D.14
1655320000	4008190408329	HDC 10B TOLLU 1PG16G	D.14
1655360000	4008190408367	HDC 24D TOLLU 1PG21G	D.14
1655380000	4008190408381	HDC 24D TOLLU 1PG29G	D.14

Order No.	EAN No.	Type	Page
1655470000	4008190408480	HDC 10B SLU 2PG16G	D.15
1655680000	4008190408701	HDC 10B SDLU 1PG16G	D.15
1655890000	4008190408916	HDC 10B KLU 1PG16G	D.15
1656390000	4008190409401	KV 11-M	H.8
1656400000	4008190409418	KV 13-M	H.8
1656410000	4008190409425	KV 16-M	H.8
1656420000	4008190409432	KV 21-M	H.8
1656430000	4008190409449	KV 29-M	H.8
1656450000	4008190409463	KV 42-M	H.8
1656480000	4008190409494	HDC 16B TBSBU 1PG21G	D.20
1656520000	4008190409531	HDC 40D TBSBU 1PG21G	D.20
1656540000	4008190409555	HDC 40D TBSBU 1PG29G	D.20
1656590000	4008190409609	HDC 16B TOBU 1PG21G	D.20
1656630000	4008190409647	HDC 40D TOBU 1PG21G	D.20
1656650000	4008190409661	HDC 40D TOBU 1PG29G	D.20
1656720000	4008190409739	HDC 16B SBU 1PG21G	D.21
1656730000	4008190409746	HDC 16B SBU 2PG21G	D.21
1656810000	4008190409821	HDC 40D SBU 2PG21G	D.21
1656830000	4008190409845	HDC 40D SBU 1PG29G	D.21
1656840000	4008190409852	HDC 40D SBU 2PG29G	D.21
1657270000	4008190410322	HDC 16B KBU 1PG21G	D.21
1657310000	4008190410360	HDC 40D KBU 1PG21G	D.21
1657380000	4008190410438	HDC 16B TBSBU 1PG21G	D.24
1657420000	4008190410476	HDC 40D TBSBU 1PG21G	D.24
1657490000	4008190410544	HDC 16B TOBU 1PG21G	D.24
1657550000	4008190410605	HDC 40D TOBU 1PG29G	D.24
1657640000	4008190410698	HDC 16B SDBO 2PG21G	D.25
1657850000	4008190410902	HDC 16B TSLU 1PG21G	D.22
1657890000	4008190410933	HDC 40D TSLU 1PG21G	D.22
1657910000	4008190410964	HDC 40D TSLU 1PG29G	D.22
1657960000	4008190411015	HDC 16B TOLLU 1PG21G	D.22
1658020000	4008190411077	HDC 40D TOLLU 1PG29G	D.22
1658110000	4008190411169	HDC 16B SLU 1PG21G	D.23
1658120000	4008190411176	HDC 16B SLU 2PG21G	D.23
1658320000	4008190411374	HDC 16B SDLU 1PG21G	D.23
1658330000	4008190411381	HDC 16B SDLU 2PG21G	D.23
1658410000	4008190411459	HDC 40D SDLU 1PG29G	D.23
1661230000	4008190417789	HDC 24B TBSBU 1PG21G	D.30
1661240000	4008190417796	HDC 24B TBSBU 1PG29G	D.30
1661300000	4008190417857	HDC 64D TBSBU 1PG21G	D.30
1661320000	4008190417871	HDC 64D TBSBU 1PG29G	D.30
1661370000	4008190417925	HDC 24B TOBU 1PG21G	D.30
1661380000	4008190417932	HDC 24B TOBU 1PG29G	D.30
1661440000	4008190417994	HDC 64D TOBU 1PG21G	D.30
1661460000	4008190418014	HDC 64D TOBU 1PG29G	D.30
1661510000	4008190418069	HDC 24B SBU 1PG21G	D.31
1661520000	4008190418076	HDC 24B SBU 2PG21G	D.31
1661590000	4008190418144	HDC 64D SBU 2PG21G	D.31
1661630000	4008190418182	HDC 64D SBU 2PG29G	D.31
1661720000	4008190418274	HDC 24B KBU 1PG21G	D.30
1661730000	4008190418281	HDC 24B KBU 1PG29G	D.31
1661810000	4008190418359	HDC 64D KBU 1PG21G	D.31
1661860000	4008190418397	HDC 24B TBSBU 1PG21G	D.34
1661880000	4008190418410	HDC 24B TBSBU 1PG29G	D.34
1661940000	4008190418472	HDC 64D TBSBU 1PG21G	D.34
1661960000	4008190418496	HDC 64D TBSBU 1PG29G	D.34
1662020000	4008190418540	HDC 24B TOBU 1PG29G	D.34
1662080000	4008190418601	HDC 64D TOBU 1PG21G	D.34
1662100000	4008190418625	HDC 64D TOBU 1PG29G	D.34
1662180000	4008190418700	HDC 24B SDBO 2PG21G	D.34
1662280000	4008190418809	HDC 64D SDBO 1PG29G	D.34
1662390000	4008190418915	HDC 24B TSLU 1PG21G	D.32
1662410000	4008190418939	HDC 24B TSLU 1PG29G	D.32
1662470000	4008190418991	HDC 64D TSLU 1PG21G	D.32
1662490000	4008190419011	HDC 64D TSLU 1PG29G	D.32
1662540000	4008190419066	HDC 24B TOLLU 1PG21G	D.32
1662550000	4008190419073	HDC 24B TOLLU 1PG29G	D.32
1662610000	4008190419134	HDC 64D TOLLU 1PG21G	D.32
1662630000	4008190419158	HDC 64D TOLLU 1PG29G	D.32
1662720000	4008190419240	HDC 24B SLU 2PG21G	D.33
1663040000	4008190419561	HDC 64D SDLU 2PG29G	D.33
1663810000	4008190420505	HDC 10A TSLU 1PG16G	D.8
1663850000	4008190420543	HDC 15A TSLU 1PG16G	D.8
1663870000	4008190420567	HDC 15A TSLU 1PG21G	D.8
1663930000	4008190420628	HDC 10A TOLLU 1PG16G	D.8
1663990000	4008190420680	HDC 15A TOLLU 1PG16G	D.8
1664040000	4008190420734	HDC 10A ALU	D.9
1664060000	4008190420758	HDC 10A ADLU	D.9
1664170000	4008190420864	HDC 10A SLU 1PG16G	D.9
1664190000	4008190420888	HDC 10A SLU 2PG16G	D.9
1664210000	4008190420901	HDC 10A SLU 1PG21G	D.9
1664330000	4008190421021	ABD-2-GR	G.13
1664350000	4008190421045	ABD-3-GR	G.13
1664370000	4008190421069	ABD-5-GR	G.13
1664390000	4008190421083	ABD-6-GR	G.13
1664410000	4008190421106	HDC 10A SDLU 1PG16G	D.9
1664420000	4008190421113	HDC 10A SDLU 2PG16G	D.9
1664560000	4008190421250	HDC 10A KLU 1PG16G	D.9
1664630000	4008190421328	HDC 15A KLU 1PG21G	D.9
1664690000	4008190421397	HDC 16A TSLU 1PG16G	D.18
1664730000	4008190421434	HDC 25A TSLU 1PG16G	D.18
1664750000	4008190421458	HDC 25A TSLU 1PG21G	D.18
1664810000	4008190421519	HDC 16A TOLLU 1PG16G	D.18
1664870000	4008190421571	HDC 25A TOLLU 1PG21G	D.18
1664920000	4008190421		

Order No.	EAN No.	Type	Page
169000000			
1698120000	4008190885038	HDC-C-M3-SM1.5AG	G.4
1698130000	4008190885045	HDC-C-M3-BM1.5AG	G.4
1698140000	4008190885052	HDC-C-M3-SM2.5AG	G.4
1698150000	4008190885069	HDC-C-M3-BM2.5AG	G.4
170000000			
1700890000	4008190900144	HDC-CM-3/CZTB0002	G.10
1700890000	4008190900144	HDC-CM-3/CZTB0002	G.4
1700900000	4008190900151	HDC-CM-20/CZC9428P	C.8
1700900000	4008190900151	HDC-CM-20/CZC9428P	G.10
1700900000	4008190900151	HDC-CM-20/CZC9428P	G.5

171000000

1712460000	4008190944032	HDC-KIT-HE 06.100	F.9
1712510000	4008190947736	HDC-KIT-HE 10.110	F.11
1712520000	4008190947743	HDC-KIT-HE 16.120	F.13
1712530000	4008190947750	HDC-KIT-HE 24.130	F.15
1712540000	4008190947767	HDC-KIT-HE 32.140	F.17
1712550000	4008190947774	HDC-KIT-HE 48.150	F.19
1712560000	4008190947781	HDC-KIT-HA 03.300	F.5
1712570000	4008190947798	HDC-KIT-HA 03.301	F.5
1712580000	4008190947804	HDC-KIT-HA 03.302	F.5
1712590000	4008190947811	HDC-KIT-HA 04.400	F.7
1712600000	4008190947828	HDC-KIT-HA 04.401	F.7
1712610000	4008190947835	HDC-KIT-HA 04.402	F.7
1712630000	4008190947866	HDC-KIT-HA 03.404	F.5
1712650000	4008190947880	HDC-KIT-HA 04.406	F.7
1712660000	4008190947897	HDC-KIT-HE 06.101	F.9
1712670000	4008190947903	HDC-KIT-HE 10.111	F.11
1712680000	4008190947910	HDC-KIT-HE 16.121	F.13
1712690000	4008190947927	HDC-KIT-HE 24.131	F.15
1712700000	4008190947934	HDC-KIT-HE 06.200	F.9
1712710000	4008190947941	HDC-KIT-HE 10.210	F.11
1712720000	4008190947958	HDC-KIT-HE 16.220	F.13
1712730000	4008190947965	HDC-KIT-HE 24.230	F.15
1718770000	4008190351977	VG 48-K68	H.6
1718780000	4008190352004	VG 48-MS54	H.8
1718790000	4008190352011	VG 48-MS68	H.9
1718800000	4008190352028	VG 7-MS54-ZE	H.9
1718810000	4008190352035	VG 9-MS54-ZE	H.9
1718820000	4008190352042	VG 11-MS54-ZE	H.9
1718830000	4008190352059	VG 13,5-MS54-ZE	H.9
1718840000	4008190352066	VG 16-MS54-ZE	H.9
1718850000	4008190352073	VG 21-MS54-ZE	H.9
1718860000	4008190352080	VG 29-MS54-ZE	H.9
1718870000	4008190352097	VG 36-MS54-ZE	H.9
1718880000	4008190352104	VG 42-MS54-ZE	H.9
1718890000	4008190352111	VG 48-MS54-ZE	H.9
1718970000	4008190352196	VG 48-EXE SW	H.10
1718980000	4008190352202	VG 48-EXI BL	H.10
1718990000	4008190352219	VG 7-EXE MS	H.11
1719000000	4008190352226	VG 9-EXE MS	H.11
1719010000	4008190352233	VG 11-EXE MS	H.11
1719020000	4008190352240	VG 13,5-EXE MS	H.11
1719030000	4008190352257	VG 16-EXE MS	H.11
1719040000	4008190352264	VG 21-EXE MS	H.11
1719050000	4008190352271	VG 29-EXE MS	H.11
1719060000	4008190352288	VG 36-EXE MS	H.11
1719070000	4008190352295	VG 42-EXE MS	H.11
1719080000	4008190352301	VG 48-EXE MS	H.11
1719250000	4008190352509	VP 7-K54	H.13
1719260000	4008190352516	VP 48-K54	H.13
1719270000	4008190352523	VP 48-MS65	H.13
1719440000	40081903525691	GWDR PG7-PO	H.12
1719450000	4008190352707	GWDR PG9-PO	H.12
1719460000	4008190352714	GWDR PG11-PO	H.12
1719470000	4008190352721	GWDR PG13,5-PO	H.12
1719480000	4008190352745	GWDR PG16-PO	H.12
1719490000	4008190352752	GWDR PG21-PO	H.12
1719500000	4008190352769	GWDR PG29-PO	H.12
1719510000	4008190352776	GWDR PG36-PO	H.12
1719520000	4008190352783	GWDR PG42-PO	H.12
1719530000	4008190352790	GWDR PG48-PO	H.12
1719540000	4008190352806	GWDR PG7-NP	H.12
1719550000	4008190352813	GWDR PG9-NP	H.12
1719560000	4008190352820	GWDR PG11-NP	H.12
1719570000	4008190352837	GWDR PG13,5-NP	H.12
1719580000	4008190352844	GWDR PG16-NP	H.12
1719590000	4008190352851	GWDR PG21-NP	H.12
1719600000	4008190352868	GWDR PG29-NP	H.12
1719610000	4008190352875	GWDR PG36-NP	H.12
1719620000	4008190352882	GWDR PG42-NP	H.12
1719630000	4008190352899	GWDR PG48-NP	H.12
172000000			
1720470000	4008190358686	VG 7-K68 SKS	H.7
1720480000	4008190358693	VG 9-K68 SKS	H.7
1720490000	4008190358709	VG 11-K68 SKS	H.7
1720500000	4008190358716	VG 13,5-K68 SKS	H.7
1720510000	4008190358723	VG 16-K68 SKS	H.7
1720520000	4008190358730	VG 21-K68 SKS	H.7
1724000000	4008190367770	HDC-KIT-HSB 06.500	F.20

Order No.	EAN No.	Type	Page
173000000			
1730120000	4008190384678	HDC-CM-4SZF AG	C.5
1730130000	4008190384685	HDC-CM-4BZF AG	C.5
1736230000	4008190956028	GWDR M16-NP	H.12
1736240000	4008190956035	GWDR M20-NP	H.12
1736250000	4008190956042	GWDR M25-NP	H.12
1736260000	4008190956059	GWDR M32-NP	H.12
1736270000	4008190956066	GWDR M40-NP	H.12
1736280000	4008190956073	GWDR M50-NP	H.12
1736290000	4008190956080	GWDR M63-NP	H.12
1737210000	4008190956684	VG M16-EXE MS	H.11
1737220000	4008190956691	VG M20-EXE MS	H.11
1737230000	4008190956707	VG M25-EXE MS	H.11
1737240000	4008190956714	VG M32-EXE MS	H.11
1737250000	4008190956721	VG M40-EXE MS	H.11
1737260000	4008190956738	VG M50-EXE MS	H.11
1737270000	4008190956745	VG M63-EXE MS	H.11
1737280000	4008190956752	VG M16-EXE SW	H.10
1737290000	4008190956769	VG M20-EXE SW	H.10
1737300000	4008190956776	VG M25-EXE SW	H.10
1737310000	4008190956783	VG M32-EXE SW	H.10
1737320000	4008190956790	VG M40-EXE SW	H.10
1737330000	4008190956806	VG M50-EXE SW	H.10
1737340000	4008190956813	VG M63-EXE SW	H.10
1737350000	4008190956820	VG M16-EXI BL	H.10
1737360000	4008190956837	VG M20-EXI BL	H.10
1737370000	4008190956844	VG M25-EXI BL	H.10
1737380000	4008190956851	VG M32-EXI BL	H.10
1737390000	4008190956868	VG M40-EXI BL	H.10
1737400000	4008190956882	VG M50-EXI BL	H.10
1737410000	4008190956905	VG M63-EXI BL	H.10
1739190000	4008190955175	HDC-HA16FD	G.14
1739200000	4008190955182	HDC-HA10FD	G.14
1739210000	4008190955199	HDC-HA32FD	G.14
1739220000	4008190955205	HDC-HA3FD	G.14

174000000

1745760000	4008190985486	HDC HE 6 FT	B.18
1745770000	4008190985493	HDC HE 10 FT	B.20
1745780000	4008190985509	HDC HE 16 FT	B.22
1745790000	4008190985516	HDC HE 16 FT	B.26
1745790000	4008190985516	HDC HE 24 FT	B.26
1745790000	4008190985516	HDC HE 24 FT	B.28
1745800000	4008190985523	HDC HE 16 FT 17-32	B.28
1745810000	4008190985530	HDC HE 24 FT 25-48	B.28
1745820000	4008190985547	HDC HE 6 MT	B.18
1745830000	4008190985554	HDC HE 10 MT	B.20
1745840000	4008190985561	HDC HE 16 MT	B.22
1745840000	4008190985561	HDC HE 16 MT	B.26
1745850000	4008190985578	HDC HE 24 MT	B.24
1745860000	4008190985585	HDC HE 16 MT 17-32	B.26
1745870000	4008190985592	HDC HE 24 MT 25-48	B.28
1746060000	4008190986476	MODUFLEX C-CR	C.32
1746070000	4008190986483	MODUFLEX C-MW	C.32

175000000

1751770001	403224801507	THM MT30X 32/9 SI/M	G.9
1751771044	403224801484	THM MT30X 32/9 WS/M	G.9
1751771687	403224801491	THM MT30X 32/9 GE/M	G.9
1752970000	4032248190614	MODUFLEX C-MH/ZE	C.33
1758340000	4032248019496	HDC CM HE 4 MC MR	C.4
1758350000	4032248019502	HDC CM HE 4 FC MR	C.4
1758360000	4032248019588	HDC CM 3 FC	C.3
1758370000	4032248019595	HDC CM 3 MC	C.3
1758380000	4032248019601	HDC CM 5 MC	C.6
1758390000	4032248019618	HDC CM 5 FC	C.6
1758400000	4032248019625	HDC CM 10 MC	C.7
1758410000	4032248019632	HDC CM 10 FC	C.7
1758420000	4032248019649	HDC-CM-20SCG GR	C.8
1758430000	4032248019656	HDC-CM-20BCG GR	C.8
1758440000	4032248019663	HDC-CR6-2S GR	C.18
1758450000	4032248019670	HDC-CR6-2B GR	C.18
1758460000	4032248019687	HDC-CR10-3S GR	C.20
1758470000	4032248019694	HDC-CR10-3B GR	C.20
1758480000	4032248019700	HDC-CR16-5S GR	C.22
1758490000	4032248019717	HDC-CR16-5B GR	C.22
1758500000	4032248019724	HDC-CR24-7S GR	C.24
1758510000	4032248019731	HDC-CR24-7B GR	C.24
1758520000	4032248019748	HDC-CR16-SS-2 GR	C.26
1758530000	4032248019755	HDC-CR16-SS-2 GR	C.26
1758540000	4032248019762	HDC-CR24-7S-2 GR	C.28
1758550000	4032248019779	HDC-CR24-7B-2 GR	C.28

176000000

1765570000	4032248059805	MODUFLEX C-KITO.M.MW-1F	C.33
1765580000	4032248059799	MODUFLEX C-KITO.M.MW-2F	C.33
1765590000	4032248059812	MODUFLEX C-KITO.M.MW-3F	C.33
1765600000	4032248059829	MODUFLEX C-KITO.M.MW-4F	C.33
1765610000	4032248059836	MODUFLEX C-KITO.M.MW-5F	C.33
1766120000	4008190078386	PTSC BK 30X6 WH1412	C.32
1766130000	4008190081140	ABST.BOLZ.M3X27+KLSC-KI	C.32

Order No.	EAN No.	Type	Page
177000000			
1772200000	4032248129850	VG M12 - MS 68	H.9
1772220000	4032248129874	VG M20 - MS 68	H.9
1772270000	4032248129928	VG M63 - MS 68	H.9
1772280000	4032248129935	VG M12 - K 68	H.6
1772300000	4032248129966	VG M20 - K 68	H.6
1772350000	4032248130016	VG M63 - K 68	H.6
1773630000	4032248142736	HDC-C-HD-S-LWL1.0POF	

Order No.	EAN No.	Type	Page
1827590000	4032248332694	HDC HB 24 EMVK SS 2xM40	E.16
1827600000	4032248332700	HDC HB 24 IP68 SS 2xM40	E.8
1827610000	4032248332816	HDC HB 16 EMVK SS 2xM32	E.15
1827620000	4032248332823	HDC HB 16 IP68 SS 2xM32	E.7
1827630000	4032248332830	HDC HB 10 EMVK SS 2xM32	E.14
1827640000	4032248332847	HDC HB 10 IP68 SS 2xM32	E.6
1827650000	4032248332854	HDC HB 6 EMVK SS 2xM25	E.13
1827660000	4032248332861	HDC HB 6 IP68 SS 2xM25	E.5
1827670000	4032248332878	HDC HA 3 EMVK SS 1xM20	E.12
1827680000	4032248332885	HDC HA 3 IP68 SS 1xM20	E.4
1827760000	4032248333080	Cabtitle KEL 24/10	H.17
1827770000	4032248333097	Cabtitle KEL SNAP 16	H.17
1827780000	4032248333103	Cabtitle KEL SNAP 24	H.17
1827790000	4032248333110	Cabtitle KT 3 b	H.15
1827800000	4032248333325	Cabtitle KT 4 b	H.15
1827810000	4032248333332	Cabtitle KT 5 b	H.15
1827830000	4032248333141	Cabtitle KT 6 b	H.15
1827840000	4032248333158	Cabtitle KT 7 b	H.15
1827850000	4032248333165	Cabtitle KT 8 b	H.15
1827860000	4032248333172	Cabtitle KT 9 b	H.15
1827870000	4032248333189	Cabtitle KT 10 b	H.15
1827880000	4032248333196	Cabtitle KT 11 b	H.15
1827890000	4032248333202	Cabtitle KT 12 b	H.15
1827900000	4032248333417	Cabtitle KT 13 b	H.15
1827910000	4032248333424	Cabtitle KT 14 b	H.15
1827920000	4032248333431	Cabtitle KT 15 b	H.15
1827930000	4032248333448	Cabtitle KT 16 b	H.15
1827940000	4032248333455	Cabtitle KT 17 b	H.15
1827950000	4032248333462	Cabtitle KT 18 b	H.15
1827960000	4032248333479	Cabtitle KT 19 b	H.15
1827970000	4032248333486	Cabtitle KT 20 b	H.15
1827980000	4032248333493	Cabtitle KT 21 b	H.15
1827990000	4032248333509	Cabtitle KT 22 b	H.15
1828000000	4032248333516	Cabtitle KT 23 b	H.15
1828010000	4032248333523	Cabtitle KT 24 b	H.15
1828020000	4032248333530	Cabtitle KT 25 b	H.15
1828030000	4032248333537	Cabtitle KT 26 b	H.15
1828040000	4032248333544	Cabtitle KT 27 b	H.15
1828050000	4032248333551	Cabtitle KT 28 b	H.15
1828060000	4032248333558	Cabtitle KT 29 b	H.15
1828070000	4032248333565	Cabtitle KT 30 b	H.15
1828080000	4032248333572	Cabtitle KT 31 b	H.15
1828090000	4032248333579	Cabtitle KT 32 b	H.15
1828100000	4032248333586	Cabtitle KT 33 b	H.15
1828110000	4032248333593	Cabtitle KT ASI a	H.15
1828120000	4032248333600	Cabtitle KT 2/4 b	H.15
1828130000	4032248333607	Cabtitle KT 2/5 b	H.15
1828140000	4032248333614	Cabtitle KT 2/6 b	H.15
1828150000	4032248333621	Cabtitle KT 4/5 b	H.15
1828160000	4032248333628	Cabtitle BTK	H.15
1828170000	4032248333635	Cabtitle BTG	H.15
1828180000	4032248333642	Cabtitle ATG	H.15
1828190000	4032248333649	Cabtitle BT BK b	H.15
1828200000	4032248333656	Cabtitle KT BTG b	H.15
1828210000	4032248333663	Cabtitle ATG black	H.15
1828220000	4032248333670	Cabtitle KVT 63/4	H.19
1828230000	4032248333677	Cabtitle KVT 63/1	H.19
1828240000	4032248333684	Cabtitle SUBD9 b	H.19
1828250000	4032248333691	Cabtitle KVT 25 b	H.19
1828260000	4032248333698	Cabtitle KVT 32 b	H.19
1828270000	4032248333705	Cabtitle KVT 63/4 b	H.19
1828280000	4032248333712	Cabtitle KVT 63/1 b	H.19
1828290000	4032248333719	Cabtitle SUBD9 b	H.19
1828300000	4032248333726	HDC CM 2SS	C.10
1828310000	4032248333733	HDC CM 1SS +PE	C.10
1828320000	4032248333740	HDC CM 2BS	C.10
1828330000	4032248333747	HDC CM 1BS +PE	C.10
1828340000	4032248333754	HDC HB 24 EMVK AS M6	E.8
1828350000	4032248333761	HDC HB 24 IP68 AS M6 D	E.8
1828360000	4032248333768	HDC HB 16 EMVK AS M6	E.15
1828370000	4032248333775	HDC HB 16 IP68 AS M6 D	E.7
1828380000	4032248333782	HDC HB 10 EMVK AS M6	E.14
1828390000	4032248333789	HDC HB 10 IP68 AS M6 D	E.6
1828400000	4032248333796	HDC HB 6 EMVK AS M6	E.13
1828410000	4032248333803	HDC HB 6 IP68 AS M6 D	E.5
1828420000	4032248333810	HDC HB 24 IP68 AS M6	E.8
1828430000	4032248333817	HDC HB 24 IP68 AS M6 D	E.7
1828440000	4032248333824	HDC HB 16 IP68 AS M6	E.6
1828450000	4032248333831	HDC HB 16 IP68 AS M6 D	E.5
1828460000	4032248333838	HDC HB 10 IP68 AS M6	E.6
1828470000	4032248333845	HDC HB 10 IP68 AS M6 D	E.6
1828480000	4032248333852	HDC HB 6 IP68 AS M6	E.5

Order No.	EAN No.	Type	Page
1840000000			
1845980000	4032248361991	HDC HB 48 TEK AS M4	E.19
1846000000	4032248362110	HDC HB 48 TIP AS M4	E.11
1846100000	4032248362127	HDC HB 24 TEK AS M4	E.18
1846200000	4032248362141	HDC HB 24 TIP AS M4	E.10
1848550000	4032248371679	DSTV HE BL6 S	B.112
1848570000	4032248371686	DSTV HE BL10 S	B.114
1848580000	4032248371693	DSTV HE BL16 S	B.116
1848590000	4032248371709	DSTV HE BL24 S	B.118
1848600000	4032248371914	DSTV HE BR6 S	B.112
1848610000	4032248371921	DSTV HE BR10 S	B.114
1848620000	4032248371938	DSTV HE BR16 S	B.116
1848630000	4032248371945	DSTV HE BR24 S	B.118
1848660000	4032248371952	DSTV HE SL6 S	B.112
1848680000	4032248371969	DSTV HE SL10 S	B.114
1848700000	4032248371976	DSTV HE SL16 S	B.116
1848730000	4032248371983	DSTV HE SL24 S	B.118
1848740000	4032248371990	DSTV HE SR6 S	B.112
1848750000	4032248372003	DSTV HE SR10 S	B.114
1848760000	4032248372017	DSTV HE SR16 S	B.116
1848770000	4032248372020	DSTV HE SR24 S	B.118
1849760000	4032248378371	Cabtitle KEL 24/7	H.17
1849770000	4032248378388	Cabtitle KEL 16/5	H.17
1849780000	4032248378395	Cabtitle Sample Kit	H.14
1850000000			
1853300000	4032248387373	HDC HB 48 TIP TVS 1xM50G	E.11
1853310000	4032248387380	HDC HB 48 TEK TVS 1xM50G	E.19
1855680000	4032248397617	HDC-HB10 AWWL FD	G.14
1855950000	4032248398713	HDC-HA48 FD	G.14
1855960000	4032248398720	HDC-HB6 FD	G.14
1855970000	4032248398737	HDC-HB10 FD	G.14
1855980000	4032248398744	HDC-HB16 FD	G.14
1855990000	4032248398751	HDC-HB24 FD	G.14
1856000000	4032248398768	HDC-H32 FD	G.14
1856010000	4032248398775	HDC-H48 FD	G.14
1860000000			
1861900000	4032248425044	HDC CM HE 4 FC	C.4
1861920000	4032248425068	HDC CM HE 4 MC	C.4
1862000000	4032248425433	HDC CM HV 3 MC MR	C.9
1862030000	4032248425464	HDC CM 10 FC MR	C.7
1862050000	4032248425488	HDC CM 10 MC MR	C.7
1862060000	4032248425495	HDC CM HV 3 FC	C.9
1862070000	4032248425501	HDC CM HV 3 FC MR	C.9
1862080000	4032248425518	HDC CM HV 3 MC	C.9
1866710000	4032248437030	Removal Tool CM 3	G.11
1866710000	4032248437030	Removal Tool CM 3	G.4
1866720000	4032248437047	Removal Tool CM 5	G.11
1866720000	4032248437047	Removal Tool CM 5	G.4
1866730000	4032248437054	Removal Tool HD	G.11
1866730000	4032248437054	Removal Tool HD	G.3
1866730000	4032248437054	Removal Tool HD	G.5
1866730000	4032248437054	Removal Tool HD	G.7
1866740000	4032248437061	Removal Tool CM 20	G.11
1866740000	4032248437061	Removal Tool CM 20	G.5
1866750000	4032248437078	Removal Tool HE	G.11
1866750000	4032248437078	Removal Tool HE	G.3
1867360000	4032248438341	HDC SHIELD LEVER 8 SC	G.15
1867370000	4032248438358	HDC SHIELD LEVER 6 SC	G.15
1867380000	4032248438365	HDC SHIELD LEVER 4 SC	G.15
1867390000	4032248438372	HDC SHIELD LEVER 3 SC	G.15
1870000000			
1873520000	4032248457779	HDC HE 6 FP	B.18
1873530000	4032248457786	HDC HE 6 MP	B.18
1873540000	4032248458158	HDC HE 10 FP	B.20
1873550000	4032248458165	HDC HE 10 MP	B.20
1873560000	4032248458172	HDC HE 16 FP	B.22
1873570000	4032248458179	HDC HE 16 MP	B.22
1873570000	4032248458189	HDC HE 16 MP	B.26
1873580000	4032248458196	HDC HE 24 FP	B.24
1873590000	4032248458202	HDC HE 24 FP	B.28
1873590000	4032248458202	HDC HE 24 MP	B.28
1873860000	4032248458370	HDC HA 10 FC	B.8
1873870000	4032248458387	HDC HA 10 MC	B.8
1873880000	4032248458394	HDC HA 16 FC	B.10
1873880000	4032248458394	HDC HA 16 FC	B.12
1873880000	4032248458394	HDC HA 16 FC	B.14
1873890000	4032248458400	HDC HA 16 MC	B.10
1873890000	4032248458400	HDC HA 16 MC	B.12
1873890000	4032248458400	HDC HA 16 MC	B.14
1873890000	4032248458400	HDC HA 16 MC	B.16
1873890000	4032248458400	HDC HA 16 MC	B.18
1873890000	4032248458400	HDC HA 16 MC	B.20
1873890000	4032248458400	HDC HA 16 MC	B.22
1873890000	4032248458400	HDC HA 16 MC	B.24
1873890000	4032248458400	HDC HA 16 MC	B.26
1873890000	4032248458400	HDC HA 16 MC	B.28
1873890000	4032248458400	HDC HA 16 MC	B.30
1873890000	4032248458400	HDC HA 16 MC	B.32
1873890000	4032248458400	HDC HA 16 MC	B.34
1873890000	4032248458400	HDC HA 16 MC	B.36
1873890000	4032248458400	HDC HA 16 MC	B.38
1873890000	4032248458400	HDC HA 16 MC	B.40
1873890000	4032248458400	HDC HA 16 MC	B.42
1873890000	4032248458400	HDC HA 16 MC	B.44
1873890000	4032248458400	HDC HA 16 MC	B.46
1873890000	4032248458400	HDC HA 16 MC	B.48
1873890000	4032248458400	HDC HA 16 MC	B.50
1873890000	4032248458400	HDC HA 16 MC	B.52
1873890000	4032248458400	HDC HA 16 MC	B.54
1873890000	4032248458400	HDC HA 16 MC	B.56
1873890000	4032248458400	HDC HA 16 MC	B.58
1873890000	4032248458400	HDC HA 16 MC	B.60
1873890000	4032248458400	HDC HA 16 MC	B.62
1873890000	4032248458400	HDC HA 16 MC	B.64
1873890000	4032248458400	HDC HA 16 MC	B.66
1873890000	4032248458400	HDC HA 16 MC	B.68
1873890000	4032248458400	HDC HA 16 MC	B.70
1873890000	4032248458400	HDC HA 16 MC	B.72
1873890000	4032248458400	HDC HA 16 MC	B.74
1873890000	4032248458400	HDC HA 16 MC	B.76
1873890000	4032248458400	HDC HA 16 MC	B.78
1873890000	4032248458400	HDC HA 16 MC	B.80
1873890000	4032248458400	HDC HA 16 MC	B.82
1873890000	4032248458400	HDC HA 16 MC	B.84
1873890000	4032248458400	HDC HA 16 MC	B.86
1873890000	4032248458400	HDC HA 16 MC	B.88
1873890000	4032248458400	HDC HA 16 MC	B.90
1873890000	4032248458400	HDC HA 16 MC	B.92
1873890000	4032248458400	HDC HA 16 MC	B.94
1873890000	4032248458400	HDC HA 16 MC	B.96
1873890000	4032248458400	HDC HA 16 MC	B.98
1873890000	4032248458400	HDC HA 16 MC	B.100

Order No.	EAN No.	Type	Page
1879010000	4032248473533	HDC CM 5 FC MR	C.6
1879020000	4032248473540	HDC CM 5 MC MR	C.6
1879030000	4032248473557	HDC CM 3 MC MR	C.3
1879040000	4032248473564	HDC CM 3 FC MR	C.3
1890000000			
1894710000	4032248509188	HDC-CM-2SPN4.0	C.11
1894720000	4032248509195	HDC-CM-1BPN4.0	C.11
189473000			

Order No.	EAN No.	Type	Page
1904350000	4032248585298	HDC 64D SBU 1M32G	D.31
1904400000	4032248585236	HDC 64D SDBO 1M32G	D.34
1904430000	4032248585106	HDC 64D SDLU 1M25G	D.33
1904440000	4032248585212	HDC 64D SDLU 1M32G	D.33
1904480000	4032248585090	HDC 64D SLU 1M25G	D.33
1904490000	4032248585618	HDC 64D SLU 1M32G	D.33
1908480000		HDC CM Bus M4 CT	C.17
1908490000		HDC CM Bus F2	C.16
1908500000		HDC CM Bus F4 CT	C.17
1908510000		HDC CM Bus GCA	C.17
1908520000		HDC CM Bus M1 CT	C.17
1908530000		HDC CM Bus M2	C.16
1908540000		HDC CM Bus F1 CT	C.17
1909660000	4032248536580	VG M12-K67	H.6
1909670000	4032248536597	VG M16-K67 4-8	H.6
1909680000	4032248536603	VG M16-K67 5-10	H.6
1909690000	4032248536610	VG M20-K67 6-12	H.6
1909700000	4032248536627	VG M20-K67 10-14	H.6
1909710000	4032248536634	VG M25-K67	H.6
1909720000	4032248536641	VG M32-K67	H.6
1909730000	4032248536658	VG M40-K67	H.6
1909740000	4032248536665	VG M50-K67	H.6
1909750000	4032248536672	VG M63-K67	H.6
1909760000	4032248536689	VG PG7-K67	H.6
1909770000	4032248536696	VG PG9-K67	H.6
1909780000	4032248536702	VG PG11-K67	H.6
1909790000	4032248536719	VG PG13,5-K67	H.6
1909800000	4032248536726	VG PG16-K67	H.6
1909810000	4032248536733	VG PG21-K67	H.6
1909820000	4032248536740	VG PG29-K67	H.6
1909830000	4032248536757	VG PG36-K67	H.6
1909840000	4032248536764	VG PG42-K67	H.6
1909850000	4032248536771	VG PG48-K67	H.6
1909860000	4032248536788	VG M16-1/K68	H.6
1909870000	4032248536795	VG M25-1/K68	H.6
1909880000	4032248536801	VG M32-1/K68	H.6
1909890000	4032248536818	VG M40-1/K68	H.6
1909900000	4032248536825	VG M50-1/K68	H.6
1909910000	4032248536832	VG M16-1/MS68	H.9
1909920000	4032248536849	VG M25-1/MS68	H.9
1909930000	4032248536856	VG M32-1/MS68	H.9
1909940000	4032248536863	VG M40-1/MS68	H.9
1909950000	4032248536870	VG M50-1/MS68	H.9

Order No.	EAN No.	Type	Page
9450000000			
9457300000	4032248173853	ABD-1-Stahlblech	G.13

1910000000

1912190000	4032248541515	HDC SHIELD CLAMP 4.5	G.16
1912200000	4032248541522	HDC SHIELD CLAMP 5.0	G.16
1912210000	4032248541539	HDC SHIELD CLAMP 6.0	G.16
1912220000	4032248541546	HDC SHIELD CLAMP 7.0	G.16
1912230000	4032248541553	HDC SHIELD CLAMP 8.0	G.16
1912240000	4032248541560	HDC SHIELD CLAMP 9.0	G.16
1912250000	4032248541577	HDC SHIELD CLAMP 10.0	G.16
1912440000	4032248542031	HDC HQ 5 MC	B.106
1912460000	4032248542055	HDC HQ 5 FC	B.106
1913320000	4032248543663	GWDR M12-NP	H.12
1919970000	4032248557943	HDC HQ 8 MC	B.108
1919980000	4032248557950	HDC HQ 8 FC	B.108

1920000000

1921720000	4032248562909	VG H M20 MS	H.8
1921740000	4032248563012	VG H M25 MS	H.8
1921760000	4032248563029	VG H M32 MS	H.8
1921770000	4032248563036	VG H M40 MS	H.8

1930000000

1934770000	4032248592029	HDC GRIP PANEL 8 SC	G.17
------------	---------------	---------------------	------

9000000000

9002650000	4008190020163	KT 8	G.7
9004530000	4008190041991	DW RSV 1.6	G.11

9010000000

9010950000	4032248331543	HTX-HDC/POF	G.11
9010950000	4032248331543	HTX-HDC/POF	G.7
9012710000	4008190118761	CZB 1	G.10
9012710000	4008190118761	CZB 1	G.3
9018480000	4008190884581	CTX CM 3.6	G.10
9018480000	4008190884581	CTX CM 3.6	G.4
9018490000	4008190884598	CTX CM 1.6/2.5	G.10
9018490000	4008190884598	CTX CM 1.6/2.5	G.3
9018490000	4008190884598	CTX CM 1.6/2.5	G.4
9018490000	4008190884598	CTX CM 1.6/2.5	G.5

9020000000

9020360000	4032248300556	AM LWL/POF	G.11
9020360000	4032248300556	AM LWL/POF	G.7
9020390000	4032248300570	PS LWL/POF	G.11
9020390000	4032248300570	PS LWL/POF	G.7
9020400000	4032248300587	PB LWL/POF	G.11
9020400000	4032248300587	PB LWL/POF	G.7

Worldwide activities

- AE UAE**
United Arab Emirates
 Weidmüller Middle-East
 P.O. Box 62448
 Dubai
 Phone +971 4 3522215, 3523043
 Fax +971 4 3599950
 info@weidmueller.ae
- AR Argentina**
 CPI SA
 Bauness 2660
 1431 Buenos Aires
 Phone +54 11 45238008
 Fax +54 11 45220546
 compbras@cpi.com.ar
- AT Austria**
 Weidmüller Ges.m.b.H.
 Industriezentrum Nö Süd
 Straße 2, Objekt M2
 2355 Wiener Neudorf
 Phone +43 2236 6708-0
 Fax +43 2236 6708-199
 office.at@weidmueller.com
- AU Australia**
 Weidmüller Pty. Ltd.
 43 Huntingwood Drive
 Huntingwood,
 NSW, 2148
 P.O.Box 6944
 Blacktown
 NSW, 2148
 Phone +61 2 9671-9999
 Fax +61 2 9671-9911
 info@weidmuller.com.au
 www.weidmuller.com.au
- AZ Azerbaijan**
 West Industries Ltd.
 Caspian Plaza, 5-th Floor
 44 J. Jabbarly Str., Baku, Azerbaijan
 Phone +99412 499 15 15
 Fax +99412 499 14 93
 sales@west-i.com
- BA Bosnia-Herzegovina**
 BH ES Elektrosistem d.o.o.
 ul. J. Veselinovica 18
 78000 Banja Luka
 Bosna
 Phone +387 51 317500
 Fax +387 51 317500
 elsist@inecco.net
 www.elektrosistem.co.yu
- BE Belgium**
 Weidmüller Benelux B.V.
 Ambachtenlaan 11 A
 3001 Heverlee
 Phone +32 16 395990
 Fax +32 16 401051
 info@weidmueller.be
- BG Bulgaria**
 Weid-Bul eOOD
 ul. Nezabavka 33 A,
 bl. 315/3/10
 1113 Sofia
 Phone +359 2 9632560
 Fax +359 2 9631098
 weidbul@nat.bg
- BH Bahrain**
 Khayber Trading Company
 P.O. Box 1976 Manama,
 Bahrain
 Phone +973 17720747
 Fax +973 17720331
 khayber@batelco.com.bh
- BR Brazil**
 Conexel Conexoes Elétricas Ltda.
 Rua Garcia Lorca, 176- V. Paulicéia,
 09695-900, Sao Bernardo do
 Campo - SP, Brasil
 Phone +55 11 43669600
 Fax +55 11 43621677
 vendas@conexel.com.br
 www.conexel.com.br
- BY Belarus**
 TECHNIKON Ltd.
 Oktyabrskaya Str. 16/5
 Apt. 704
 220030 Minsk
 Belarus
 Phone +375 17 2104626
 Fax +375 17 2275830
 technikon@belsonet.net
- CA Canada**
 W Interconnections Canada Inc.
 10 Spy Court, Markham,
 Ontario L3 R5 H6
 Phone +1 905 475-1507
 Fax +1 905 475-5855
 info1@weidmuller.ca
 www.weidmuller.ca
- CH Switzerland**
 Weidmüller Schweiz AG
 Rundbuckstrasse 2
 8212 Neuhausen am Rheinfall
 Phone +41 52 6740707
 Fax +41 52 6740708
 info@weidmueller.ch
 www.weidmueller.ch
- CL Chile**
 Felipe Bahamondes S.A./ATS AGRO
 Servicios Agroindustriales
 Maria Luisa Santander 0475
 Providencia
 Casilla 3425
 Santiago
 Phone +56 2 341-1271
 Fax +56 2 341-1275
 felipe@atsintech.com
- CN China**
 Weidmüller Interface International
 Trading (Shanghai) Co., Ltd.
 12 F, Century Ba-Shi Building,
 No. 398 Huahai Road (M)
 Shanghai 200020
 P.R. China
 Phone +86 21 63868188
 Fax +86 21 63867177
 www.cnweidmuller.com
- CO Colombia**
 Automatizacion Avanzada S. A.
 Carrera 97 No. 42 A-23 B3,
 Santafe de Bogotá Colombia.
 Phone +57 1 4132048
 Fax +57 1 4159788
 mgallegos@
 automatizacionavanzada.com
- CR Costa Rica**
 ELVATRON S.A.
 400 Norte
 Banco Costa Rica, la Uruca,
 San José, Costa Rica
 Phone +506 2 961060
 Fax +506 2 960328
 dirk.haase@elvatron.com
- CS Serbia and Montenegro**
 ES-YU Elektrosistem
 Pariske komune 41
 11070 Novi Beograd
 Serbia
 Phone +381 11 697212
 Fax +381 11 693608
 esyu@eunet.yu
 www.elektrosistem.co.yu
- CZ Czech Republic**
 Weidmüller s. r. o.
 Videnska ul. 340
 25242 Vestec u Prahy
 Phone +420 2 44001400
 Fax +420 2 44001499
 office@weidmueller.cz
- DE Germany**
 Weidmüller GmbH & Co. KG
 Ohmstraße 9
 32758 Detmold
 Phone +49 5231 1428-0
 Fax +49 5231 1428-116
 weidmueller@weidmueller.de
 www.weidmueller.de
- DK Denmark**
 Knud Wexøe A/S
 Skaettekaeret 11
 P.O. Box 152
 2840 Holte
 Phone +45 45465800
 Fax +45 45465801
 wexoe@wexoe.dk
- EE Estonia**
 Alter Electric OÜ
 Türi 6, 11313 Tallinn, Estonia
 Phone +372 65 19 666
 Fax +372 65 19667
 alter@alter.ee
- EG Egypt**
 Standard Electric
 87, Mohamed Farid Street
 Heliopolis, Cairo, Egypt
 Phone +20 6 42 29 77/6 42 29 88
 Fax +20 6 42 29 55
 stdelec@rite.com
- ES Spain**
 Weidmüller S. A.
 Narcis Monturiol 11-13
 Pol.Ind. Sudoeste
 08960 Sant Just Desvern
 Barcelona
 Phone +34 93 4803386
 Fax +34 93 3718055
 weidmuller@weidmuller.es
 www.weidmuller.es
- FI Finland**
 JUHA-ELEKTRO OY
 Kyivöpolku 6, P. O. Box 57
 00681 Helsinki
 Phone +358 9 478411
 Fax +358 9 47841311
- FR France**
 Weidmüller EURL
 12, Chaussée Jules César
 B.P. 263 Osny
 95523 CERGY PONTOISE Cedex
 Phone +33 1 34245500
 Fax +33 1 34245501
 mail@weidmuller.fr
 www.weidmueller.com
- GB United Kingdom**
 Weidmüller Ltd.
 1 Abbey Wood Road
 Kings Hill, West Malling
 Kent ME19 4YT
 Phone +44 1732 877000
 Fax +44 1732 873873
 info@weidmuller.co.uk
 www.weidmueller.com
- GR Greece**
 Electrorama S.A.
 1 An. Martali Str.
 41335 Larissa
 Phone +30 2410 552533
 Fax +30 2410 283463
 valvizos@electrorama.com.gr
- HK Hong Kong**
 United Equity Limited
 Suite B, 11/F International Industrial
 Centre
 2-8 Kwei Tei Street, Fotan, Shatin
 Hong Kong
 Phone +852 26876739
 Fax +852 26876735
 united_equity@sinatown.com
- HR Croatia**
 Elektro Partner d.o.o.
 Radnicka cesta 22
 10000 Zagreb
 Phone +385 1 6184793
 Fax +385 1 6184795
 elektropartner@zg.htnet.hr
- HU Hungary**
 Weidmüller Kereskedelmi Kft
 Dombóvári út 13
 1117 Budapest
 P. O. Box 22
 1507 Budapest
 Phone +36 1 464-7888
 Fax +36 1 3827701
 info@weidmueller.hu
- ID Indonesia**
 P. T. Nego Electrindo
 Komplek Sentra Kramat, Blok A18
 Jl. Kramat Raya No. 7-9
 Jakarta 10450 Indonesia
 Phone +62 21 3156218
 Fax +62 21 3156219
 sutrisno@negoelectrindo.co.id
- IE Ireland**
 A.P. Haslam Ltd.
 14 Sunshine Ind. Estate
 Crumlin Road
 Dublin 12
 Phone +353 1 453-2522
 Fax +353 1 453-2949
 paul.haslam@aphaslam.ie
- IL Israel**
 A.U. Shay Ltd.
 Embar Street 23/25
 P.O.Box 10049
 Petach-Tikva 49222
 Phone +972 3 9233601
 Fax +972 3 9234601
 shay@uriel-shay.com
- IN India**
 Weidmüller
 Representative office
 Vijay Dattani
 # 156-4th cross, Prashant Extension
 Whitefield
 Bangalore - 560 066
 Phone +91 80 8453999
 vtdattani@eth.net
- IR Iran**
 TAF Co.
 72, Iranshahr Av.
 Unit 5,
 15816 Teheran
 Phone +98 21 8831-7851
 Fax +98 21 8882-0268
 info@taf-co.com
- IS Iceland**
 Samey Automation Center
 Lyngas 13, 210 Garoabaer,
 Iceland
 Phone +354 510 5200
 Fax +354 510 5201
 samey@samey.is
- IT Italy**
 Weidmüller S.r.l.
 Via Albert Einstein 4
 20092 Cinisello Balsamo
 Milano
 Phone +39 02 660681
 Fax +39 02 6124945
 weidmuller@weidmuller.it
 www.weidmuller.it
- JO Jordan**
 Horizons Engineering
 P.O. Box 330607 ZC
 11133 Amman
 Phone +962 64882114
 Fax +962 4882115
 horizons@ggo.com.jo
- JP Japan**
 Nihon Weidmüller Co. Ltd.
 Asahi Seimei Bldg. 11F
 1-14-1 Fuchicho Fuchu-shi
 Tokyo 183-0055 Japan
 Phone +81 42 330-7891
 Fax +81 42 330-7895
 www.weidmuller.co.jp
- KR South Korea**
 Weidmüller Co., Ltd.
 2 floor Woomam B/D 46-27
 Samsung2-Dong, Kangnam-Ku
 Seoul
 Korea, Zip: 135-868
 Phone +82 2 5160003
 Fax +82 2 5160090
 info@weidmuller.co.kr
- KW Kuwait**
 NOURI Industrial Establishment Co.
 P.O.Box 2829,
 Safat 13029 Kuwait
 Phone +965 4333355
 Fax +965 4344085
 contact@nie-kwt.com
- KZ Kazakhstan**
 SEA STAR
 58-A, Office 609, Abilay Khan Aven.
 Almaty, 50004
 Kazakhstan
 Phone +7 3272 733307
 Fax +7 3272 501780
 alexander@seastargroup.com
- KZ Kazakhstan**
 Electric Light LLP
 84, Auezov Street
 Office 310
 480057 Almaty
 Kazakhstan
 Phone +7 3272 421709
 Fax +7 3272 779955
 wgm@nursat.kz



- LB Lebanon**
Progress Engineering & Trading Enterprises
P.O. Box 11-1111
Pharaon Bldg., Opp Electr. du Liban
Chafaca Str., Al Nahr
Beirut - Lebanon
Phone +961 1 444664
Fax +961 1 561880
progress@inco.com.lb
- LT Lithuania**
ELEKTROS IRANGA
Tinklu g.29a, 5319 Panevezys, Lithuania
Phone +370 45582828
Fax +370 45582727
info@eliranga.lt
- LU Luxembourg**
Please contact
Weidmüller Belgium, Heverlee
- LV Latvia**
Elektrosistemas SIA
K. Ulmana gatve 140
LV-1029 Riga
Latvia
Phone +371 7870557
Fax +371 7870541
edgars.vilkins@profs.lv
www.profs.lv
- MK Macedonia**
ES MK Elektrosistem d.o.o.
Ul. Bulevar III makedonske brigade bb
91000 Skopje
Macedonia
Phone +389 91 460295
Fax +389 91 460298
elektro-smk@telekabel.net.mk
- MX Mexico**
W Interconnections, S.A. de C.V
Av. Ingenieros Civiles No. 204-B,
Conjunto Industrial Chachapa
72990 Chachapa,
Puebla Mexico
Phone +52 222 2866247/48/49
Fax +52 222 2866242
clientes@weidmuller.com.mx
- MY Malaysia**
Connect Plus Technology Sdn Bhd
9, Jalan PJS 11/24,
Bandar Sunway,
46150 Petaling Jaya,
Selangor Darul Ehsan,
Malaysia
Phone +60 3 5633 7363
Fax +60 3 5633 6562
andy@cptech.com.my
www.cptech.com.my
- NL Netherlands**
Weidmüller Benelux B.V.
Franciscusweg 221
1216 SE Hilversum
Postbus 1505
1200 BM Hilversum
Phone +31 35 6261261
Fax +31 35 6234569
info@weidmuller.nl
www.weidmuller.nl
- NO Norway**
Siv. Ing. J. F. Knudtzen A/S
Billingstadsletta 97
1396 Billingstad, P.O. Box 160
1378 Nesbru
Phone +47 66 983350
Fax +47 66 980955
patorgersbraaten@jfknuadtzen.no
- NZ New Zealand**
Cuthbert S. Steward Limited
27 Te Puni Street
POB 38496 Petone
Petone, Wellington
Phone +64 4 5686156
Fax +64 4 5686056
- OM Oman**
DAN INTERNATIONAL LLC.
P.O.BOX 2901
111 Seeb
Oman
Phone +968 503 677
Fax +968 503 755
yedu@danintl.com
- PE Peru**
TECNOLOGÍA ELÉCTRICA
Y SOLUCIONES S.A.C.
Calle Huandoy 501, Lima 32 - Perú
Phone +51 1 5620004
Fax +51 1 5620004
info@tecsol-peru.com
- PH Philippines**
El Criscent Corporation
B-41 L-10, Villa Palao,
Banlic, Calamba City
Laguna 4027,
Philippines
Phone +63 49 3456329
Fax +63 49 3456329
ecc@laguna.net
- PH Philippines**
Enclosure Systems Specialists Inc
G/F, GE Building
2291 Don Chino Roces Ave Ext
Makati City 1231,
Philippines
Phone +63 2 813 8580
Fax +63 2 813 8596
encsys@mozcom.com
- PL Poland**
Weidmüller Sp. z o.o.
ul. Gołdzinowska 10
03-302 Warszawa
Poland
Phone +48 22 5100940
Fax +48 22 5100941
biuro@weidmuller.com.pl
www.weidmuller.pl
- PT Portugal**
Weidmüller - Sistemas de
Interface, S. A.
Estrada Outeiro Polima, Lote B,
N° B2, Escritório 2 - Abóboda
2785-518 Sao Domingos de Rana
Lisboa
Phone +351 21 4459190
Fax +351 21 4455871
weidmuller@weidmuller.pt
www.weidmuller.pt
- PY Paraguay**
Rewo Paraguay S.A.
Sucre 2590 esq Emeterio Miranda
Asunción
Paraguay
Phone +595 21 60 60 13
Fax +595 21 60 60 13
rewo@telesurf.com.py
- QA Qatar**
Doha Motors
(Technical Division)
Post Box No. 145
Al Wakrath Road
Doha-Qatar
Phone +974 465 1441
Fax +974 465 4579
dmtctech@quatar.net.qa
- RO Romania**
Rominterface Impex SRL
Str. Gh. Dem Teodorescu 30A
030916 Bukarest - sector 3
Phone +40 21 3220230
Fax +40 21 3228857
romint@dnt.ro
- RU Russia**
Weidmüller Representative Office
Shabolovka street 2
119049 Russia, Moskau
Phone +7 495 771-6940
Fax +7 495 771-6941
info@weidmueller.ru
www.weidmueller.ru
- SA Saudi Arabia**
Al Abdulkarim Trading
P.O. Box 5777, Dammam
31432 Saudi Arabia
Phone +966 3 833-7110
Fax +966 3 833-8242
info@akte.com.sa
- SA Saudi Arabia**
Saudi Electric Supply Co.
P.O. Box 3298, Al Khobar
31952 Saudi Arabia
Phone +966 3 882-9546227
Fax +966 3 882-9547
customer.service@sesco-ge.com
- SE Sweden**
Weidmüller AB
Stockholm, Arenavägen 39,
12177 Johanneshov
P.O. Box 10120
12128 Stockholm-Globen
Phone +46 771 43 00 44
Fax +46 8 7272480
mail.stockholm@weidmuller.se
- SG Singapore**
Weidmüller Pte. Ltd.
629 Aljunied Road, #05-05
Cititech Industrial Building
Singapore 389838
Phone +65 6841 5311
Fax +65 6841 5377
info@weidmuller.com.sg
www.weidmuller.com.sg
- SI Slovenia**
ELEKTROPOJIL d.o.o.
Stegne 25
1000 Ljubljana
Phone +38 6 15113810
Fax +38 6 15111604
elektrospojil@siol.net
- SK Slovakia**
Elektris s.r.o.
Racianska 188
SK 83153 Bratislava, Slovakia
Phone +421 2 49200113
Fax +421 2 44680328
weidmueller@computel.sk
- SY Syria**
Hovaguimian Bros.
P.O. Box 5093
Damascus
Syria
Phone +963 11-221 84 05
Fax +96311-224 48 69
Hb.hovag@mail.sy
- TH Thailand**
Pisanu Engineering Co., Ltd
800/2 Asoke Dindaeng Road,
Dindaeng,
Bangkok 10400
Thailand
Phone +66 2 2459113
Fax +66 2 2463214
ecsales@pisanu.co.th
www.pisanu.co.th
- TR Turkey**
Weidmüller Elektronik Ticaret Ltd.Şti.
Kavacik Mah. Mhrrabad Cad. 143/1
34810 Beykoz - Istanbul / Turkey
Phone +90 216 5371070 (Pbx)
Fax +90 216 5371077
info@weidmuller.com.tr
- TW Taiwan**
Fittatek Co., Ltd.
12 F No. 185 Fu-Kuo Road,
Tso Ying Dist,
Kaohsiung, Taiwan
Phone +886 7556-0858
Fax +886 7556-3279
stanley@fittatek.com.tw
- TW Taiwan**
Eucan Enterprise Ltd.
No. 145 He Ping 2nd Rd
Kaohsiung, Taiwan
Phone +886 7 715 6610
Fax +886 7 715 8748
mark@eucan.com.tw
www.eucan.com.tw
- UA Ukraine**
TEKO Interface
Per.Industrialny 2
03056 - Kiev
Phone +380 04463 57760
Fax +380 04463 91082
elektro@panko.kiev.ua
- US USA**
W-Interconnections, Inc.
821 Southlake Boulevard, Rich-
mond, VA 23236
Phone +1 804 7942877
Fax +1 804 3792593
info@weidmuller.com
www.weidmuller.com
- UY Uruguay**
Rewo Uruguay S.A.
AV. Bolivia 2001 Esq Rocafuerte
Carrasco Montevideo
Phone +598 260 4 8439
Fax +598 260 4 8439
clorda@rewo Uruguay.com.uy
- VE Venezuela**
Somercinca C. A.
Edificio Esteban Piso 2
Calle Vargas Bolleita Notre
Caracas 1070 A
Venezuela
Phone +58 212 2352748
Fax +58 212 2385625
klocmoeller@cantv.net
- VN Vietnam**
New Sky Co., Ltd
206 Nguyen Thai Binh Str.,
Ward 12., Tan Binh Dist.,
Ho Chin Minh City
Vietnam
Phone +848 811 6768
Fax +848 811 7899
newskey-e@hcm.vnn.vn
www.newskey-e.com
- YE Yemen**
Please contact
Weidmüller Middle-East
United Arab Emirates
- ZA South Africa**
RAD Interface Pty. Ltd.
5 Bundo Road
Sebenza Extension
Edenvale 1609
P.O.Box 193
Edenvale 1610
Phone +27 11 452-1930
Fax +27 11 452-6455
alockyer@radinterface.co.za
- DE Other countries**
Weidmüller Interface GmbH & Co. KG
P.O. Box 3030
32720 Detmold
Klingenbergstraße 16
32758 Detmold
Phone +49 5231 14-0
Fax +49 5231 14-20 83
info@weidmueller.com
www.weidmueller.com
- DE** Group companies
- DE** Agency abroad
- DE** Without own Agency

We cannot guarantee that there are no mistakes in the publications or software provided by us to the customer for the purpose of making orders. We try our best to quickly correct errors in our printed media. For this purpose we list corrections, which have been identified after publishing printed media, on our web site at www.weidmueller.com. For convenience we list these corrections against product catalogue number and/or page number. This Internet-database is part of our catalogue.

All orders are based on our general terms of delivery, which can be reviewed on the websites of our group companies where you place your order. On demand we can also send the general terms of delivery to you.

Looking for pricing, stock, or lifecycle information?

Click below to explore more details on WIN SOURCE:

-  [View 1207500000 on WIN SOURCE](#)
-  [Weidmuller Information](#)

Optimize Your Supply Chain with WIN SOURCE Solutions

-  Global Sourcing Solution
-  Obsolete Management
-  Cost Control Management
-  Shortage Management
-  Alternative Solution
-  Excess Inventory Management