



**THE DATASHEET OF  
DS96176CN**



# DS96176

*DS96176 RS-485/RS-422 Differential Bus Transceiver*



Literature Number: SNLS393A

# DS96176

## RS-485/RS-422 Differential Bus Transceiver

### General Description

The DS96176 Differential Bus Transceiver is a monolithic integrated circuit designed for bidirectional data communication on balanced multipoint bus transmission lines. The transceiver meets EIA Standard RS-485 as well as RS-422A.

The DS96176 combines a TRI-STATE® differential line driver and a differential input line receiver, both of which operate from a single 5.0V power supply. The driver and receiver have an active Enable that can be externally connected to function as a direction control. The driver differential outputs and the receiver differential inputs are internally connected to form differential input/output (I/O) bus ports that are designed to offer minimum loading to the bus whenever the driver is disabled or when  $V_{CC} = 0V$ . These ports feature wide positive and negative common mode voltage ranges, making the device suitable for multipoint applications in noisy environments.

The driver is designed to handle loads up to 60 mA of sink or source current. The driver features positive and negative current-limiting and thermal shutdown for protection from line fault conditions. Thermal shutdown is designed to occur at junction temperature of approximately 160°C. The receiver features a typical input impedance of 15 k $\Omega$ , an input sensitivity of  $\pm 200$  mV, and a typical input hysteresis of 50 mV.

The DS96176 can be used in transmission line applications employing the DS96172 and the DS96174 quad differential line drivers and the DS96173 and DS96175 quad differential line receivers.

### Features

- Bidirectional transceiver
- Meets EIA Standard RS-422A and RS-485
- Designed for multipoint transmission
- TRI-STATE driver and receiver enables
- Individual driver and receiver enables
- Wide positive and negative input/output bus voltage ranges
- Driver output capability  $\pm 60$  mA Maximum
- Thermal shutdown protection
- Driver positive and Negative current-limiting
- High impedance receiver input
- Receiver input sensitivity of  $\pm 200$  mV
- Receiver input hysteresis of 50 mV typical
- Operates from single 5.0V supply
- Low power requirements

### Connection Diagram

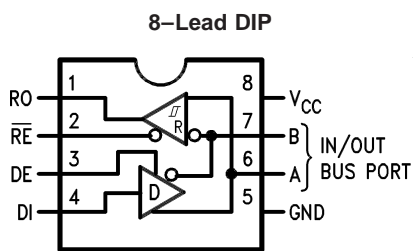

Top View  
Order Number DS96176CN  
See NS Package Number N08E

### Function Table

#### Driver

Input	Enable	Outputs	
DI	DE	A	B
H	H	H	L
L	H	L	H
X	L	Z	Z

#### Receiver

Differential Inputs	Enable	Output
A-B	$\overline{RE}$	R
$V_{ID} \geq 0.2V$	L	H
$V_{ID} \leq -0.2V$	L	L
X	H	Z

H = High Level  
L = Low Level  
X = Immaterial  
Z = High Impedance (off)

**Absolute Maximum Ratings** (Note 2)

If Military/Aerospace specified devices are required, please contact the National Semiconductor Sales Office/Distributors for availability and specifications.

Storage Temperature Range	
Molded DIP	-65°C to +150°C
Lead Temperature	
Molded DIP (soldering, 10 sec.)	265°C
Maximum Power Dissipation (Note 1) at 25°C	
Molded Package	930 mW
Supply Voltage	7.0V
Differential Input Voltage	+15V/-10V
Enable Input Voltage	5.5V

**Recommended Operating Conditions**

	Min	Typ	Max	Units
Supply Voltage ( $V_{CC}$ )	4.75	5.0	5.25	V
Voltage at Any Bus Terminal (Separately or Common Mode)	-7.0		12	V
Differential Input Voltage ( $V_{ID}$ )			±12	V
Output Current HIGH ( $I_{OH}$ )				
Driver			-60	mA
Receiver			-400	µA
Output Current LOW ( $I_{OL}$ )				
Driver			60	mA
Receiver			16	mA
Operating Temperature ( $T_A$ )	0	25	70	°C

Note 1: Derate molded DIP package 7.5 mW/°C above 25°C.

**Electrical Characteristics** (Notes 3, 4)

Over recommended temperature, common mode input voltage, and supply voltage ranges, unless otherwise specified

Symbol	Parameter	Conditions	Min	Typ	Max	Units	
<b>DRIVER SECTION</b>							
$V_{IH}$	Input Voltage HIGH		2.0			V	
$V_{IL}$	Input Voltage LOW				0.8	V	
$V_{OH}$	Output Voltage HIGH	$I_{OH} = -20$ mA		3.1		V	
$V_{OL}$	Output Voltage LOW	$I_{OL} = 20$ mA		0.85		V	
$V_{IC}$	Input Clamp Voltage	$I_I = -18$ mA			-1.5	V	
$ V_{OD1} $	Differential Output Voltage	$I_O = 0$ mA			6.0	V	
$ V_{OD2} $	Differential Output Voltage	$R_L = 100\Omega$ , Figure 1	2.0	2.25		V	
		$R_L = 54\Omega$ , Figure 1 and Figure 2	1.5	2.0			
$\Delta V_{OD2} $	Change in Magnitude of Differential Output Voltage (Note 5)	$R_L = 54\Omega$ $V_{CM} = 0V$ Figure 1 and Figure 2			±0.2	V	
		$R_L = 100\Omega$ Figure 1					
$V_{OC}$	Common Mode Output Voltage (Note 6)	$R_L = 54\Omega$ or $100\Omega$ , Figure 1			3.0	V	
$\Delta V_{OC} $	Change in Magnitude of Common Mode Output Voltage (Note 5)				±0.2	V	
$I_O$	Output Current (Note 5) (Includes Receiver $I_I$ )	Output Disabled					
		$V_O = 12V$ $V_O = -7.0V$			1.0 -0.8	mA	
$I_{IH}$	Input Current HIGH	$V_I = 2.4V$			20	µA	
$I_{IL}$	Input Current LOW	$V_I = 0.4V$			-100	µA	
$I_{OS}$	Short Circuit Output Current (Note 10)	$V_O = -7.0V$			-250	mA	
		$V_O = 0V$			-150		
		$V_O = V_{CC}$			150		
		$V_O = 12V$			250		
$I_{CC}$	Supply Current	No Load	Outputs Enabled			35	mA
			Outputs Disabled			40	
<b>RECEIVER SECTION</b>							
$V_{TH}$	Differential Input High Threshold Voltage	$V_O = 2.7V$ , $I_O = -0.4$ mA			0.2	V	
$V_{TL}$	Differential Input Low Threshold Voltage (Note 7)	$V_O = 0.5V$ , $I_O = 8.0$ mA	-0.2			V	
$V_{T+} - V_{T-}$	Hysteresis (Note 8)	$V_{CM} = 0V$		50		mV	
$V_{IH}$	Enable Input Voltage HIGH		2.0			V	
$V_{IL}$	Enable Input Voltage LOW				0.8	V	
$V_{IC}$	Enable Input Clamp Voltage	$I_I = -18$ mA			-1.5	V	

## Electrical Characteristics (Notes 3, 4) (Continued)

Over recommended temperature, common mode input voltage, and supply voltage ranges, unless otherwise specified

Symbol	Parameter	Conditions	Min	Typ	Max	Units
<b>RECEIVER SECTION</b>						
$V_{OH}$	Output Voltage HIGH	$V_{ID} = 200\text{ mV}$ , $I_{OH} = -400\text{ }\mu\text{A}$ , <i>Figure 3</i>	2.7			V
$V_{OL}$	Output Voltage LOW	$V_{ID} = -200\text{ mV}$ , <i>Figure 3</i>	$I_{OL} = 8.0\text{ mA}$		0.45	V
			$I_{OL} = 16\text{ mA}$		0.50	
$I_{OZ}$	High Impedance State Output	$V_O = 0.45\text{V to }2.4\text{V}$			$\pm 20$	$\mu\text{A}$
$I_I$	Line Input Current (Note 9)	Other Input = 0V	$V_I = 12\text{V}$		1.0	mA
			$V_I = -7.0\text{V}$		0.8	
$I_{IH}$	Enable Input Current HIGH	$V_{IH} = 2.7\text{V}$			20	$\mu\text{A}$
$I_{IL}$	Enable Input Current LOW	$V_{IL} = 0.4\text{V}$			-100	$\mu\text{A}$
$R_I$	Input Resistance			12		k $\Omega$
$I_{OS}$	Short Circuit Output Current	(Note 10)	-15		-85	mA
$I_{CC}$	Supply Current (Total Package)	No Load	Outputs Enabled		40	mA
			Outputs Disabled			

## Driver Switching Characteristics

$V_{CC} = 5\text{V}$ ,  $T_A = 25^\circ\text{C}$

Symbol	Parameter	Conditions	Min	Typ	Max	Units
$t_{DD}$	Differential Output Delay Time	$R_L = 60\Omega$ , <i>Figure 4</i>		15	25	ns
$t_{TD}$	Differential Output Transition Time	$R_L = 60\Omega$ , <i>Figure 4</i>		15	25	ns
$t_{PLH}$	Propagation Delay Time, Low-to-High Level Output	$R_L = 27\Omega$ , <i>Figure 5</i>		12	20	ns
$t_{PHL}$	Propagation Delay Time, High-to-Low Level Output	$R_L = 27\Omega$ , <i>Figure 5</i>		12	20	ns
$t_{PZH}$	Output Enable Time to High Level	$R_L = 110\Omega$ , <i>Figure 6</i>		25	35	ns
$t_{PZL}$	Output Enable Time to Low Level	$R_L = 110\Omega$ , <i>Figure 7</i>		25	35	ns
$t_{PHZ}$	Output Disable Time from High Level	$R_L = 110\Omega$ , <i>Figure 6</i>		20	25	ns
$t_{PLZ}$	Output Disable Time from Low Level	$R_L = 110\Omega$ , <i>Figure 7</i>		29	35	ns

## Receiver Switching Characteristics

$V_{CC} = 5.0\text{V}$ ,  $T_A = 25^\circ\text{C}$

Symbol	Parameter	Conditions	Min	Typ	Max	Units
$t_{PLH}$	Propagation Delay Time, Low-to-High Level Output	$V_{ID} = 0\text{V to }3.0\text{V}$ $C_L = 15\text{ pF}$ , <i>Figure 8</i>		16	25	ns
$t_{PHL}$	Propagation Delay Time, High-to-Low Level Output			16	25	ns
$t_{PZH}$	Output Enable Time to High Level	$C_L = 15\text{ pF}$ , <i>Figure 9</i>		15	22	ns
$t_{PZL}$	Output Enable Time to Low Level			15	22	ns
$t_{PHZ}$	Output Disable Time from High Level	$C_L = 5.0\text{ pF}$ , <i>Figure 9</i>		14	30	ns
$t_{PLZ}$	Output Disable Time from Low Level			24	40	ns

**Note 2:** "Absolute Maximum Ratings" are those values beyond which the safety of the device cannot be guaranteed. They are not meant to imply that the devices should be operated at these limits. The tables of "Electrical Characteristics" provide conditions for actual operation.

**Note 3:** Unless otherwise specified min/max limits apply across the  $0^\circ\text{C}$  to  $+70^\circ\text{C}$  range for the DS96176. All typicals are given for  $V_{CC} = 5\text{V}$  and  $T_A = 25^\circ\text{C}$ .

**Note 4:** All currents into the device pins are positive; all currents out of the device pins are negative. All voltages are referenced to ground unless otherwise specified.

**Note 5:**  $\Delta|V_{OD}|$  and  $\Delta|V_{OC}|$  are the changes in magnitude of  $V_{OD}$  and  $V_{OC}$ , respectively, that occur when the input is changed from a high level to a low level.

**Note 6:** In EIA Standards RS-422A and RS-485,  $V_{OC}$ , which is the average of the two output voltages with respect to ground, is called output offset voltage,  $V_{OS}$ .

**Note 7:** The algebraic convention, where the less positive (more negative) limit is designated minimum, is used in this data sheet for common mode input voltage and threshold voltage levels only.

## Receiver Switching Characteristics (Continued)

**Note 8:** Hysteresis is the difference between the positive-going input threshold voltage  $V_{T+}$ , and the negative-going input threshold voltage,  $V_{T-}$ .

**Note 9:** Refer to EIA Standard RS-485 for exact conditions.

**Note 10:** Only one output at a time should be shorted.

### Parameter Measurement Information

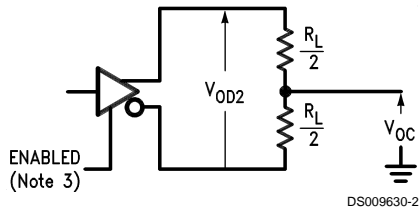

FIGURE 1. Driver  $V_{OD}$  and  $V_{OC}$

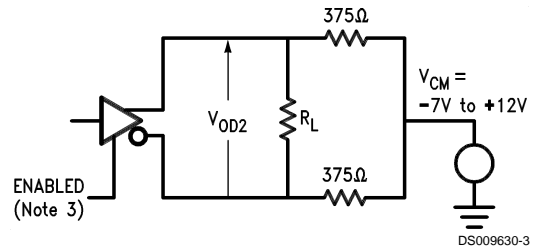

FIGURE 2. Driver  $V_{OD}$  with Varying Common Mode Voltage

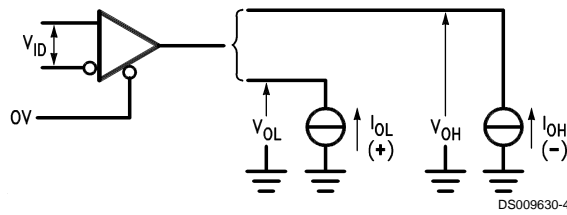

FIGURE 3. Receiver  $V_{OH}$  and  $V_{OL}$

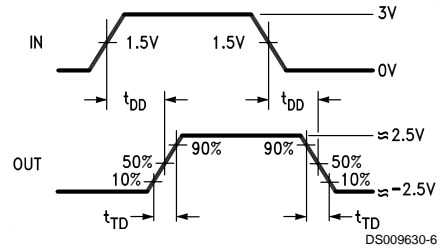
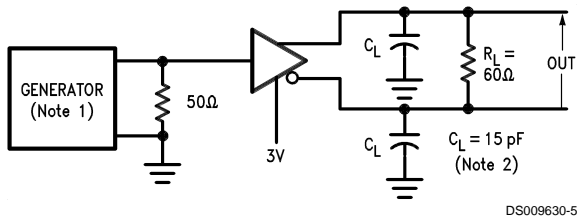

FIGURE 4. Driver Differential Output Delay and Transition Times

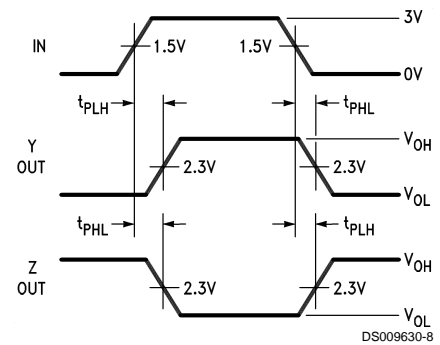
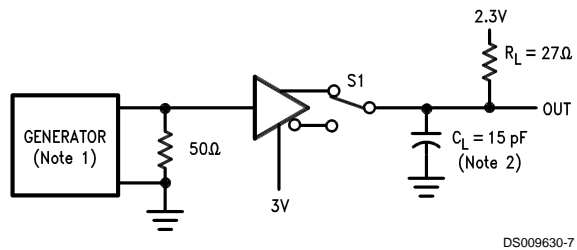
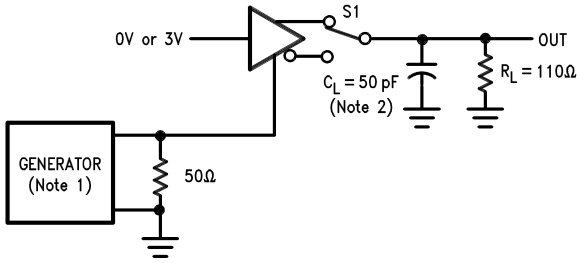

FIGURE 5. Driver Propagation Times

Parameter Measurement Information (Continued)



DS009630-9

FIGURE 6. Driver Enable and Disable Times ( $t_{PZH}$ ,  $t_{PHZ}$ )

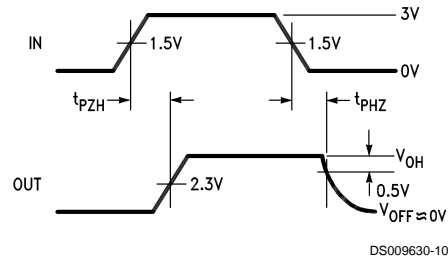

DS009630-10

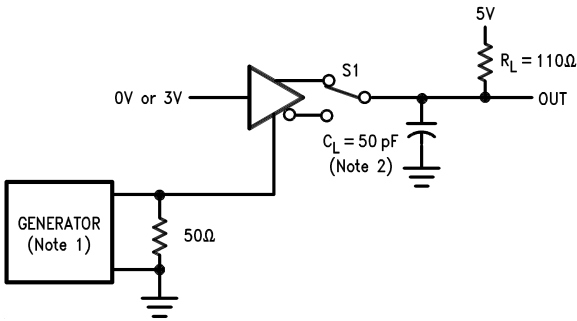

DS009630-11

FIGURE 7. Driver Enable and Disable Times ( $t_{PZL}$ ,  $t_{PLZ}$ )

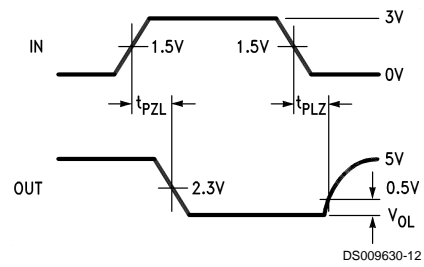

DS009630-12

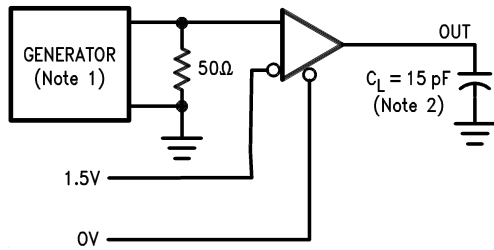

DS009630-13

FIGURE 8. Receiver Propagation Delay Times

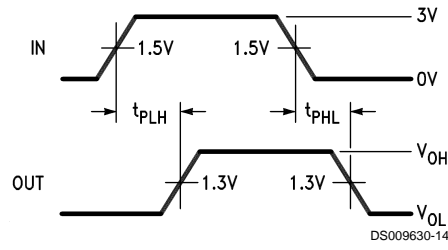

DS009630-14

Parameter Measurement Information (Continued)

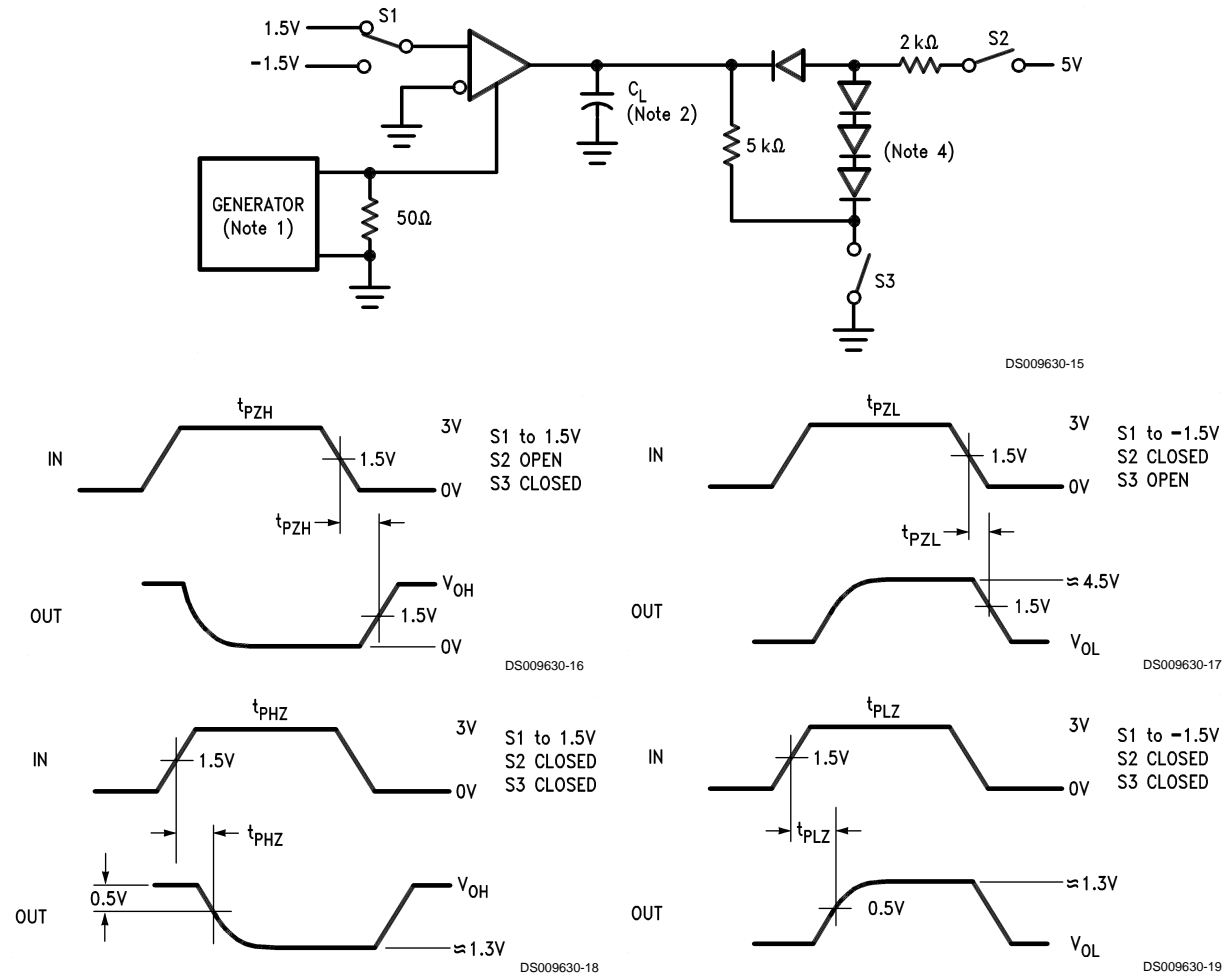

- Note 11:** The input pulse is supplied by a generator having the following characteristics: PRR = 1.0 MHz, 50% duty cycle,  $t_r \leq 6.0$  ns,  $Z_O = 50\Omega$ .
- Note 12:**  $C_L$  includes probe and stray capacitance.
- Note 13:** DS96176 Driver enable is Active-High.
- Note 14:** All diodes are 1N916 or equivalent.

FIGURE 9. Receiver Enable and Disable Times

Typical Application

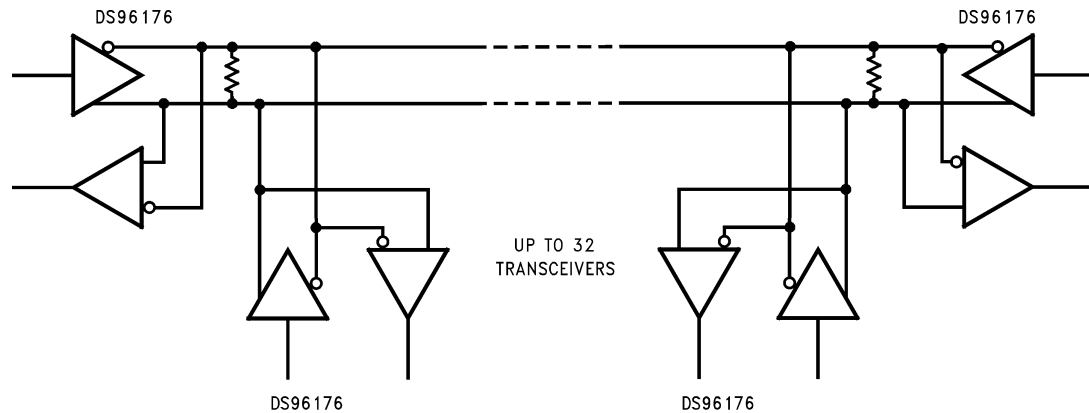

- Note:** The line length should be terminated at both ends of its characteristic impedance. Stub lengths off the main line should be kept as short as possible.

FIGURE 10.

# Typical Performance Characteristics

**Driver Differential Propagation Delay vs  $V_{CC}$  vs Temperature**

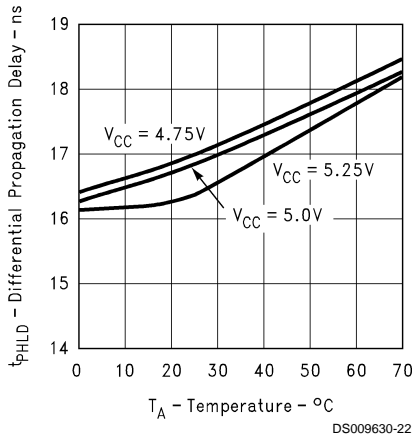

**Driver Differential Propagation Delay vs  $V_{CC}$  vs Temperature**

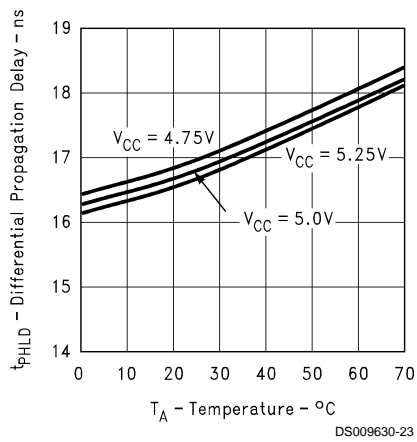

**Driver Differential Rise Time vs  $V_{CC}$  vs Temperature**

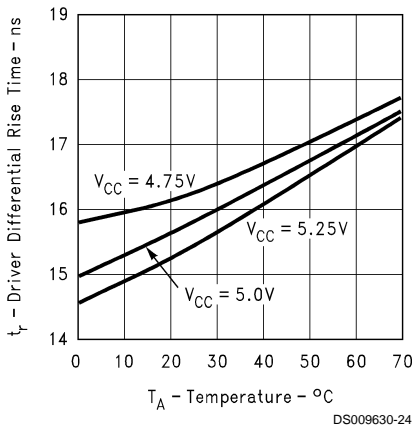

**Driver Differential Fall Time vs  $V_{CC}$  vs Temperature**

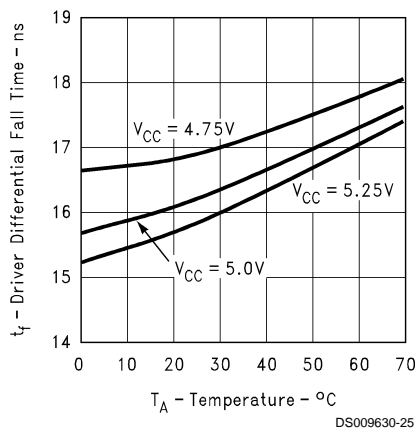

**Driver Skew vs  $V_{CC}$  vs Temperature ( $t_{PLDH} - t_{PHLD}$ )**

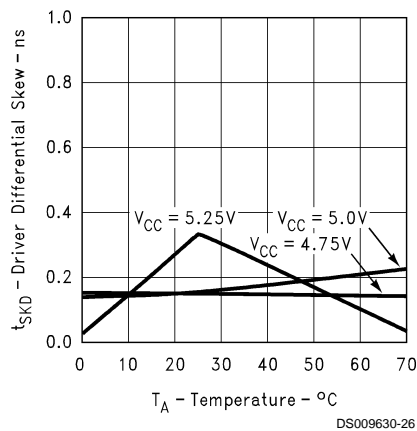

Typical Performance Characteristics (Continued)

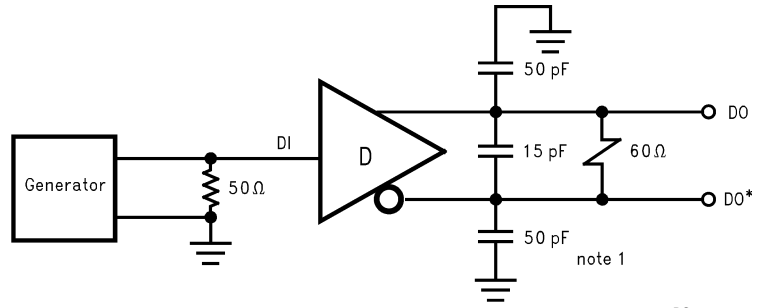

DS009630-27

FIGURE 11. Typical Curve Driver Propagation Delay Test Circuit

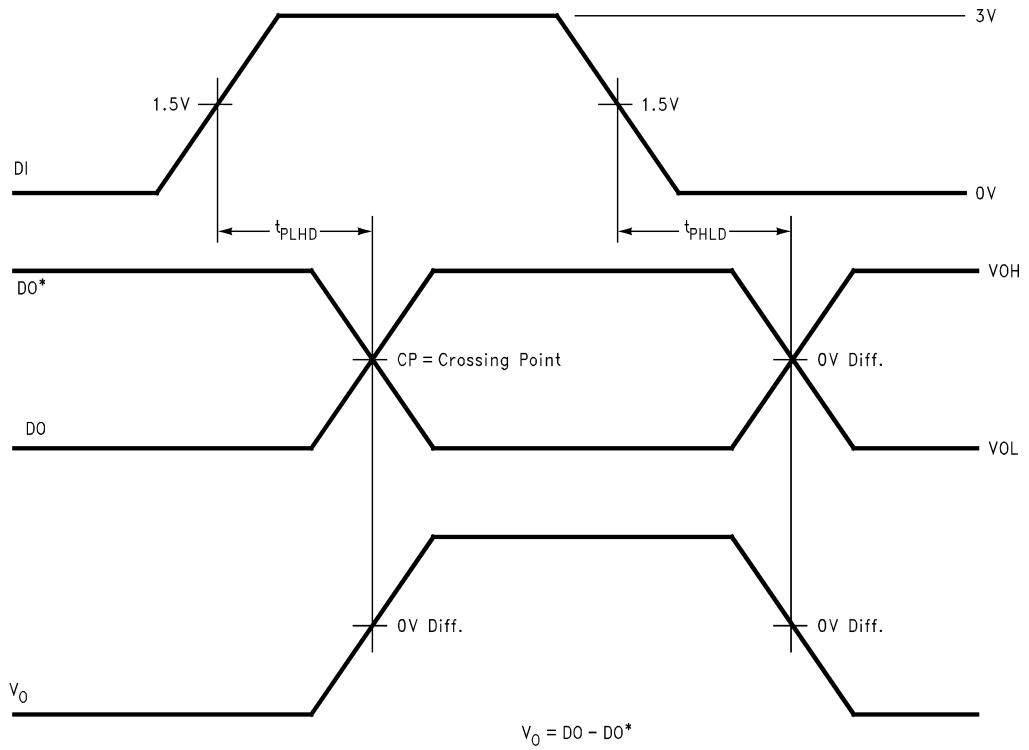

DS009630-28

FIGURE 12. Typical Curve Driver Differential Propagation Delay Timing

# Typical Performance Curves

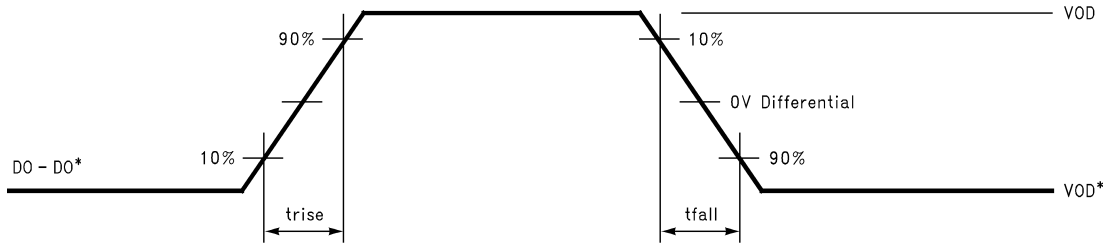

DS009630-29

FIGURE 13. Typical Curve Driver Differential Rise and Fall Times

## Receiver Propagation Delay vs $V_{CC}$ vs Temperature

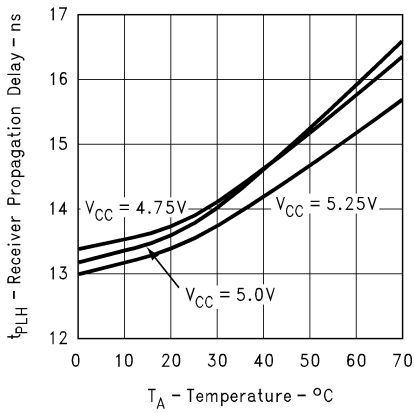

DS009630-30

## Receiver Propagation Delay vs $V_{CC}$ vs Temperature

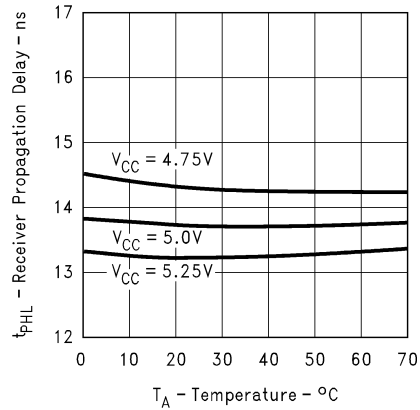

DS009630-31

## Receiver Skew vs $V_{CC}$ vs Temperature ( $t_{PLH} - t_{PHL}$ )

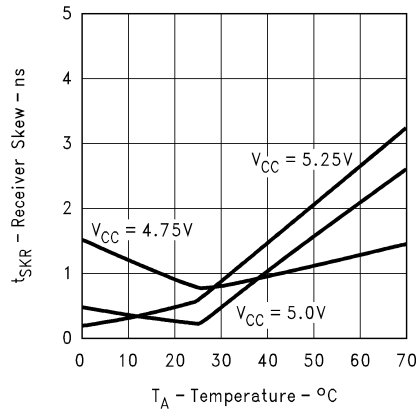

DS009630-32

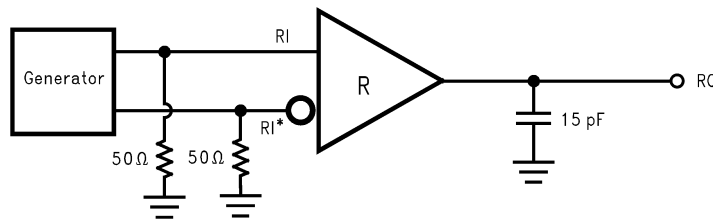

DS009630-33

FIGURE 14. Typical Curve Receiver Differential Propagation Delay Test Circuit

# Typical Performance Curves (Continued)

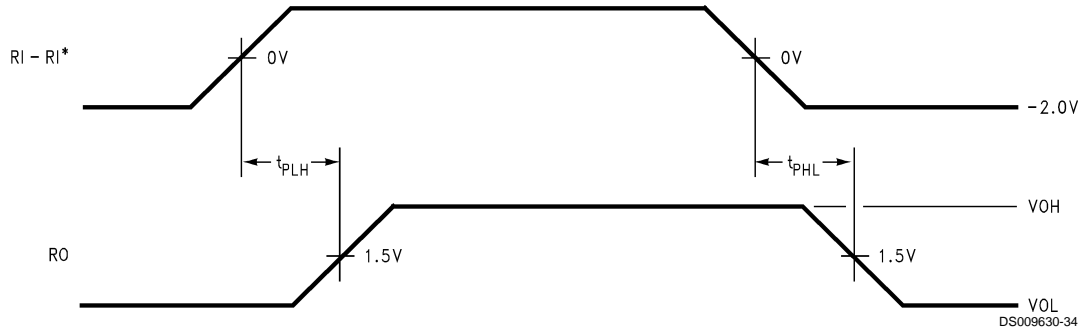
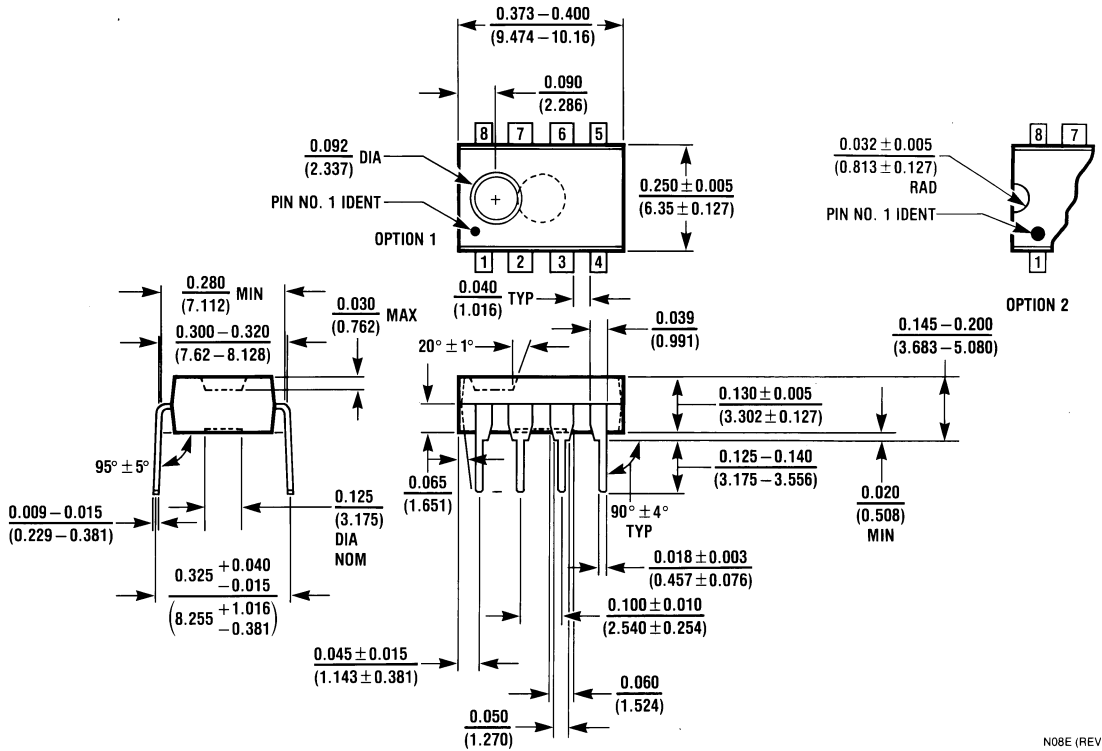

FIGURE 15. Typical Curve Receiver Propagation Delay Timing

**Physical Dimensions** inches (millimeters) unless otherwise noted



**Molded Dual-In-Line Package (N)**  
**Order Number DS96176CN**  
**NS Package Number N08E**

N08E (REV F)

**LIFE SUPPORT POLICY**

NATIONAL'S PRODUCTS ARE NOT AUTHORIZED FOR USE AS CRITICAL COMPONENTS IN LIFE SUPPORT DEVICES OR SYSTEMS WITHOUT THE EXPRESS WRITTEN APPROVAL OF THE PRESIDENT AND GENERAL COUNSEL OF NATIONAL SEMICONDUCTOR CORPORATION. As used herein:

1. Life support devices or systems are devices or systems which, (a) are intended for surgical implant into the body, or (b) support or sustain life, and whose failure to perform when properly used in accordance with instructions for use provided in the labeling, can be reasonably expected to result in a significant injury to the user.
2. A critical component is any component of a life support device or system whose failure to perform can be reasonably expected to cause the failure of the life support device or system, or to affect its safety or effectiveness.



**National Semiconductor Corporation**  
 Americas  
 Email: support@nsc.com

**National Semiconductor Europe**  
 Fax: +49 (0) 180-530 85 86  
 Email: europe.support@nsc.com  
 Deutsch Tel: +49 (0) 69 9508 6208  
 English Tel: +44 (0) 870 24 0 2171  
 Français Tel: +33 (0) 1 41 91 8790

**National Semiconductor Asia Pacific Customer Response Group**  
 Tel: 65-2544466  
 Fax: 65-2504466  
 Email: ap.support@nsc.com

**National Semiconductor Japan Ltd.**  
 Tel: 81-3-5639-7560  
 Fax: 81-3-5639-7507

www.national.com

## IMPORTANT NOTICE

Texas Instruments Incorporated and its subsidiaries (TI) reserve the right to make corrections, modifications, enhancements, improvements, and other changes to its products and services at any time and to discontinue any product or service without notice. Customers should obtain the latest relevant information before placing orders and should verify that such information is current and complete. All products are sold subject to TI's terms and conditions of sale supplied at the time of order acknowledgment.

TI warrants performance of its hardware products to the specifications applicable at the time of sale in accordance with TI's standard warranty. Testing and other quality control techniques are used to the extent TI deems necessary to support this warranty. Except where mandated by government requirements, testing of all parameters of each product is not necessarily performed.

TI assumes no liability for applications assistance or customer product design. Customers are responsible for their products and applications using TI components. To minimize the risks associated with customer products and applications, customers should provide adequate design and operating safeguards.

TI does not warrant or represent that any license, either express or implied, is granted under any TI patent right, copyright, mask work right, or other TI intellectual property right relating to any combination, machine, or process in which TI products or services are used. Information published by TI regarding third-party products or services does not constitute a license from TI to use such products or services or a warranty or endorsement thereof. Use of such information may require a license from a third party under the patents or other intellectual property of the third party, or a license from TI under the patents or other intellectual property of TI.

Reproduction of TI information in TI data books or data sheets is permissible only if reproduction is without alteration and is accompanied by all associated warranties, conditions, limitations, and notices. Reproduction of this information with alteration is an unfair and deceptive business practice. TI is not responsible or liable for such altered documentation. Information of third parties may be subject to additional restrictions.

Resale of TI products or services with statements different from or beyond the parameters stated by TI for that product or service voids all express and any implied warranties for the associated TI product or service and is an unfair and deceptive business practice. TI is not responsible or liable for any such statements.

TI products are not authorized for use in safety-critical applications (such as life support) where a failure of the TI product would reasonably be expected to cause severe personal injury or death, unless officers of the parties have executed an agreement specifically governing such use. Buyers represent that they have all necessary expertise in the safety and regulatory ramifications of their applications, and acknowledge and agree that they are solely responsible for all legal, regulatory and safety-related requirements concerning their products and any use of TI products in such safety-critical applications, notwithstanding any applications-related information or support that may be provided by TI. Further, Buyers must fully indemnify TI and its representatives against any damages arising out of the use of TI products in such safety-critical applications.

TI products are neither designed nor intended for use in military/aerospace applications or environments unless the TI products are specifically designated by TI as military-grade or "enhanced plastic." Only products designated by TI as military-grade meet military specifications. Buyers acknowledge and agree that any such use of TI products which TI has not designated as military-grade is solely at the Buyer's risk, and that they are solely responsible for compliance with all legal and regulatory requirements in connection with such use.

TI products are neither designed nor intended for use in automotive applications or environments unless the specific TI products are designated by TI as compliant with ISO/TS 16949 requirements. Buyers acknowledge and agree that, if they use any non-designated products in automotive applications, TI will not be responsible for any failure to meet such requirements.

Following are URLs where you can obtain information on other Texas Instruments products and application solutions:

### Products

Audio	<a href="http://www.ti.com/audio">www.ti.com/audio</a>
Amplifiers	<a href="http://amplifier.ti.com">amplifier.ti.com</a>
Data Converters	<a href="http://dataconverter.ti.com">dataconverter.ti.com</a>
DLP® Products	<a href="http://www.dlp.com">www.dlp.com</a>
DSP	<a href="http://dsp.ti.com">dsp.ti.com</a>
Clocks and Timers	<a href="http://www.ti.com/clocks">www.ti.com/clocks</a>
Interface	<a href="http://interface.ti.com">interface.ti.com</a>
Logic	<a href="http://logic.ti.com">logic.ti.com</a>
Power Mgmt	<a href="http://power.ti.com">power.ti.com</a>
Microcontrollers	<a href="http://microcontroller.ti.com">microcontroller.ti.com</a>
RFID	<a href="http://www.ti-rfid.com">www.ti-rfid.com</a>
OMAP Mobile Processors	<a href="http://www.ti.com/omap">www.ti.com/omap</a>
Wireless Connectivity	<a href="http://www.ti.com/wirelessconnectivity">www.ti.com/wirelessconnectivity</a>

### Applications

Communications and Telecom	<a href="http://www.ti.com/communications">www.ti.com/communications</a>
Computers and Peripherals	<a href="http://www.ti.com/computers">www.ti.com/computers</a>
Consumer Electronics	<a href="http://www.ti.com/consumer-apps">www.ti.com/consumer-apps</a>
Energy and Lighting	<a href="http://www.ti.com/energy">www.ti.com/energy</a>
Industrial	<a href="http://www.ti.com/industrial">www.ti.com/industrial</a>
Medical	<a href="http://www.ti.com/medical">www.ti.com/medical</a>
Security	<a href="http://www.ti.com/security">www.ti.com/security</a>
Space, Avionics and Defense	<a href="http://www.ti.com/space-avionics-defense">www.ti.com/space-avionics-defense</a>
Transportation and Automotive	<a href="http://www.ti.com/automotive">www.ti.com/automotive</a>
Video and Imaging	<a href="http://www.ti.com/video">www.ti.com/video</a>

TI E2E Community Home Page

[e2e.ti.com](http://e2e.ti.com)

Mailing Address: Texas Instruments, Post Office Box 655303, Dallas, Texas 75265  
Copyright © 2011, Texas Instruments Incorporated







## Looking for pricing, stock, or lifecycle information?

Click below to explore more details on WIN SOURCE:

 [View DS96176CN](#) on WIN SOURCE

 [Texas Instruments](#) Information

## Optimize Your Supply Chain with WIN SOURCE Solutions

-  Global Sourcing Solution
-  Obsolete Management
-  Cost Control Management
-  Shortage Management
-  Alternative Solution
-  Excess Inventory Management