



**THE DATASHEET OF  
M24308/25-9Z**



cannon

# D-Sub Accessories Catalog



**ITT**

# We Connect

When it matters most

For more than a century, ITT Cannon has developed innovative interconnect solutions for the world's harshest environments. With facilities in the United States, Germany, Italy, Mexico, China and Japan, each with its unique strengths, we offer our customers interconnect solutions that are truly Engineered for Life.

In addition to this truly global footprint, we offer highly specialized, segmented industry expertise. We have a proven track record as an industry leader in harsh-environment applications. This has equipped us with the knowledge needed to continue to produce the most resilient, reliable connectors for our customers' most challenging conditions.

## Interconnect solutions for the harshest environments.

### The ITT Cannon difference

- Global capabilities & local support
- Proven application expertise
- A century of interconnect leadership
- A committed innovator & business partner

The logo for Cannon, featuring the word "cannon" in a lowercase, sans-serif font. The letter "o" is replaced by a stylized icon of a three-pronged electrical plug.

### About ITT

ITT is a diversified leading manufacturer of highly engineered critical components and customized technology solutions for the energy, transportation and industrial markets. Building on its heritage of innovation, ITT partners with its customers to deliver enduring solutions to the key industries that underpin our modern way of life. Founded in 1920, ITT is headquartered in White Plains, N.Y., with employees in more than 35 countries and sales in a total of approximately 125 countries. For more information, visit [www.itt.com](http://www.itt.com).

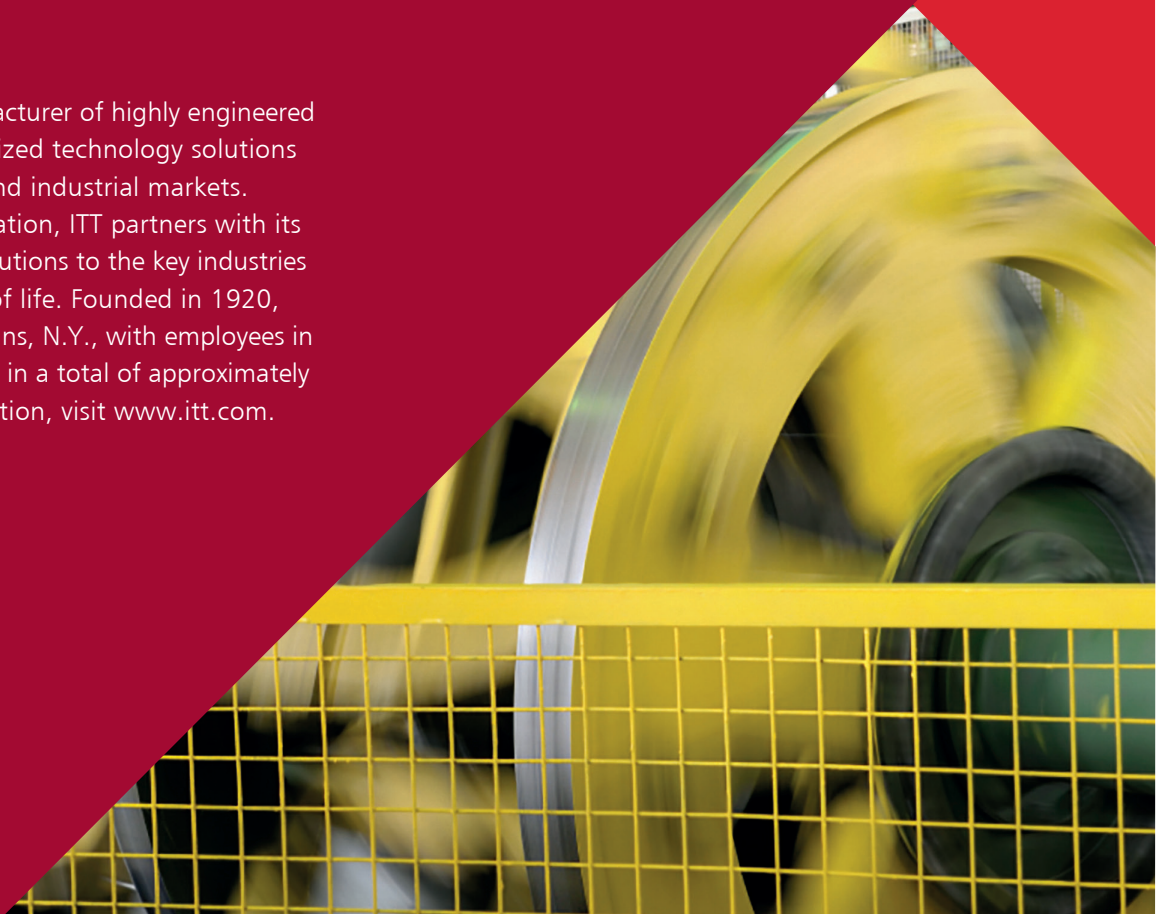



Industrial/Instrumentation



Defense Vehicles



Medical



Heavy Equipment



Rail



Oil & Gas



Commercial & Military Aerospace

Our connector portfolio remains the most extensive in the industry.

Offering a reliable and cost effective range of interconnect solutions.

# Introduction to D-Sub Accessories

Originally designed & patented by Cannon engineers for use on commercial & military aviation systems, D-Sub Connectors were manufactured as a smaller, lightweight alternative to many of the large, heavier circular electronic plugs of the time. This small but robust rectangular interconnect solution was quickly adopted across a number of applications and industries, and the Cannon D-Sub soon became the first multi-purpose connector of its kind.

Today, Cannon offers an array of commercial or military grade D-Sub styles, sizes, configurations and accessories.

- EMI Shielded, Metal or Plastic Backshells
- Straight or Angled Exit
- One –Piece Snap Together or Locking Backshells
- Locking Hardware
- Guide Pin Plates
- Interfacial Seals
- Dust Camps

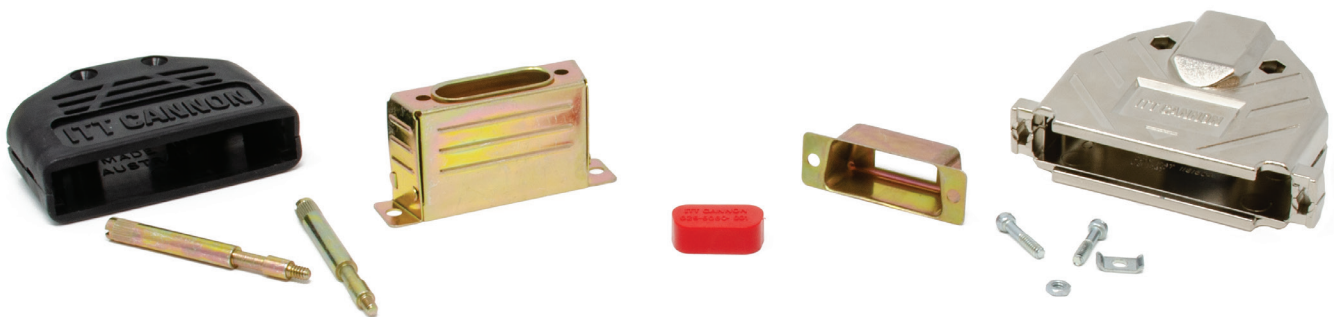

# Table of contents

---

We Connect when it matters most .....	2
Introduction to D-Sub Accessories .....	4
Accessory Selection Guide .....	6
Metal Backshell	
Die Cast Zinc, EMI Shielded Straight Exit .....	8
Metal Backshell Straight Exit .....	9
Metal Backshell 45° Exit .....	10
Clamps.....	11-12
Plastic Backshell	
Snap-Together Metalized Plastic, EMI Shielded .....	13
Locking Hardware for Snap-Together	
Plastic Backshell.....	14
Low Cost Metalized Plastic, Straight Exit .....	14
Snap-Together Universal.....	15
One-Piece Snap-Together .....	15
One-Piece Straight Exit .....	16
One-Piece Plastic, 90° Exit.....	16
Locking Hardware	
Screw Lock Assemblies .....	17-18
Slide Lock Assemblies .....	19
Spring Latch Assemblies .....	20
Jackscrew/Jackpot Assemblies.....	21
Guide Pin Plate	
Female Guide Pin Plate .....	22
Male Guide Pin Plate .....	23
Connector Saver	
High Reliability Connector Saver.....	24
Miscellaneous	
Polarizing Plates .....	25
Right Angle Brackets.....	25
Wire Hole Fillers .....	25
Dust Cap .....	26
Interfacial Seal.....	26
Potting Shell.....	26
Part Number Index .....	27
About ITT Cannon.....	28
Product Safety Warranty.....	29

---

# D-Sub Accessories Guide for Backshells and Locking Hardware

## Backshell Locking Hardware

Backshell Material	Backshell Style	Female Screw Lock see page 18	Male crew Lock see page 17	Sliding Lock Retainer see page 19	Slide Lock Post see page 19	Spring Latch Plate see page 20
EMI Shielded	Snap-Together Metalized Plastic Straight Exit see page 13	—	—	—	—	—
EMI Shielded	Snap-Together Metalized Plastic 50° Exit see page 13	—	—	—	—	—
EMI Shielded	Die Cast Zinc Metal see page 10	—	□	—	—	—
Metal	Metal Backshell 45° Exit see page 8	—	—	—	—	—
Metal	Deep Straight Clamp see page 11	●	●	●	●	●
Metal	Round Cable Clamp see page 11	●	●	●	●	●
Metal	Short Straight Clamp see page 12	●	●	●	●	●
Metal	90° Entry see page 12	●	●	●	●	●
Plastic	Snap-Together Universal see page 15	●	●	—	—	—
Plastic	One-Piece Snap-Together see page 15	—	□	—	—	—
Plastic	One-Piece Plastic Straight Exit see page 16	—	—	●	●	●
Plastic	One-Piece Plastic 90° Exit see page 16	—	—	●	●	●

□ Supplied with backshell ● Optional compatible locking hardware — Not compatible

## Locking Hardware

Backshell Style	Spring Latch see page 20	Jackscrew Assembly see page 21	Jackpost Assembly see page 21	Recessed Jackscrew see page 14	Extended Jackscrew see page 14	Thumbscrew see page 14	Jackpost for In-Line Connections see page 14
Snap-Together Metalized Plastic Straight Exit see page 13	—	—	—	●	●	●	●
Snap-Together Metalized Plastic 50° Exit see page 13	—	—	—	●	●	●	●
Die Cast Zinc Metal see page 10	—	—	—	—	—	—	—
Metal Backshell 45° Exit see page 8	—	—	—	—	—	—	—
Deep Straight Clamp see page 11	—	—	●	—	—	—	—
Round Cable Clamp see page 11	—	—	●	—	—	—	—
Short Straight Clamp see page 12	—	—	●	—	—	—	—
90° Entry see page 12	—	—	—	—	—	—	—
Snap-Together Universal see page 15	—	—	—	—	—	—	—
One-Piece Snap-Together see page 15	—	—	—	—	—	—	—
One-Piece Plastic Straight Exit see page 16	—	—	—	—	—	—	—
One-Piece Plastic 90° Exit see page 16	—	—	—	—	—	—	—

□ Supplied with backshell    ● Optional compatible locking hardware    — Not compatible

# Metal Backshell

## Die Cast Zinc Backshell, Straight Exit, EMI Shielded

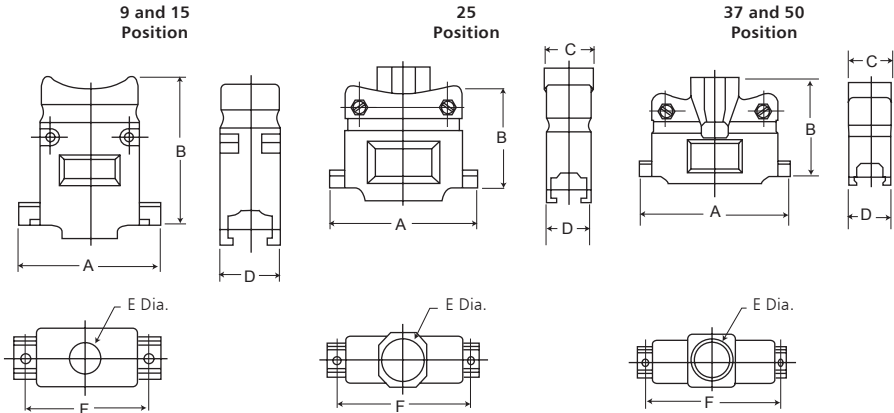
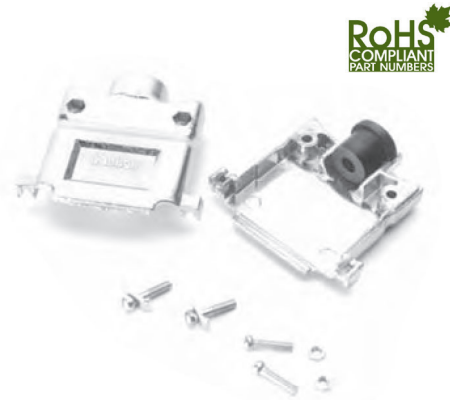

Die cast metal backshells reduce EMI/RFI emissions. Die cast metal backshells offer improved shielding in a rugged package.

### Product Features

- Improves conformance to FCC DOC #20780 shielding requirements
- No crimp ferrule tooling needed
- Kit consists of 1 front shell, 1 rear shell, 2 screws, 2 hex nuts, 2 mounting screws, 2 end brackets, 1 set of compression inserts

Shell size	Layout	Part Number	A ±0,13 (.005)	B ±0,13 (.005)	C ±0,13 (.005)	D ±0,13 (.005)	øE ±0,13 (.005)	F ±0,13 (.005)
DE	9	980-2000-345	31,12 (1.225)	37,21 (1.465)	15,75 (.620)	15,75 (.620)	10,16 (.400)	24,99 (.984)
DA	15	980-2000-346	39,12 (1.540)	40,64 (1.600)	15,75 (.620)	15,75 (.620)	10,16 (.400)	33,32 (1.312)
DB	25	980-2000-347	53,09 (2.090)	39,37 (1.550)	17,53 (.690)	15,75 (.620)	13,34 (.525)	47,17 (1.857)
DC	37	980-2000-348	69,34 (2.730)	45,72 (1.800)	21,95 (.864)	15,75 (.620)	18,44 (.726)	63,50 (2.500)
DD	50	980-2000-349	66,70 (2.626)	45,72 (1.800)	21,95 (.864)	18,54 (.730)	18,44 (.726)	61,11 (2.406)

Specifications	
Attenuation:	-50 dB @ 1000MHz
Temperature Range:	-20° C to 80° C

Materials and Finishes	
Backshell Material:	Zinc
Backshell Finish:	Clear Zinc
Compression Inserts:	PVC
Hardware Material:	Steel
Hardware Finish:	Clear Zinc

### Attenuation

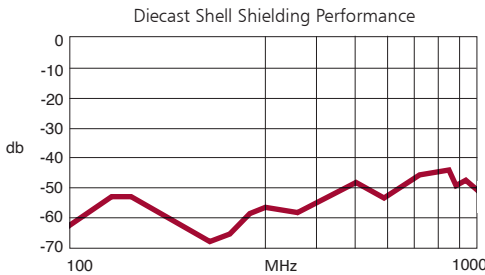

9 and 15 Position\*

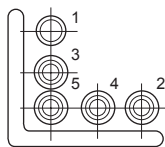

Cable Diameter  
4,83/8,89 (.190/.350)

\* Inserts may be supplied mirror image.

25 Position\*

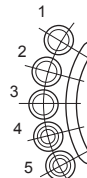

Cable Diameter  
4,83/11,68 (.190/.460)

37 and 50 Position\*

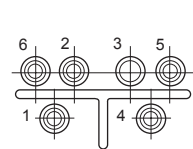

Cable Diameter  
7,62/17,27 (.300/.680)

Compression inserts (included with die cast zinc metal backshell)

Compression inserts accommodate a wide variety of cable sizes.

Position	#1		#2		#3		#4		#5		#6	
	O.D.	I.D.	O.D.	I.D.	O.D.	I.D.	O.D.	I.D.	O.D.	I.D.	O.D.	I.D.
9,15	12,07 (.475)	8,13 (.320)	9,14 (.360)	8,00 (.315)	9,14 (.360)	6,48 (.255)	9,14 (.360)	7,24 (.285)	9,14 (.360)	5,33 (.210)	-	-
25	15,24 (.600)	11,43 (.450)	11,43 (.450)	10,41 (.410)	11,43 (.450)	9,40 (.370)	11,43 (.450)	7,62 (.300)	11,43 (.450)	5,84 (.230)	-	-
37,50	16,64 (.655)	14,48 (.570)	17,78 (.700)	15,75 (.620)	20,57 (.810)	16,51 (.650)	16,64 (.655)	12,70 (.500)	16,64 (.655)	10,80 (.425)	16,64 (.655)	8,89 (.350)



Dimensions shown in mm  
Specifications and dimensions subject to change

www.ittcannon.com

## Metal Backshell Straight Exit - D\*FM

D\*FM metal Backshells for D-Subminiature Connectors offers protection from magnetic and radio interferences to cable assemblies.



### Product Features

- No crimp ferrule tooling needed
- Material: Zinc, blue chromated
- Unique metal filled plastic cable strain relief guarantees 360° shielding
- RoHS compliant
- -40 - +120°C temperature range
- Corrosion resistant

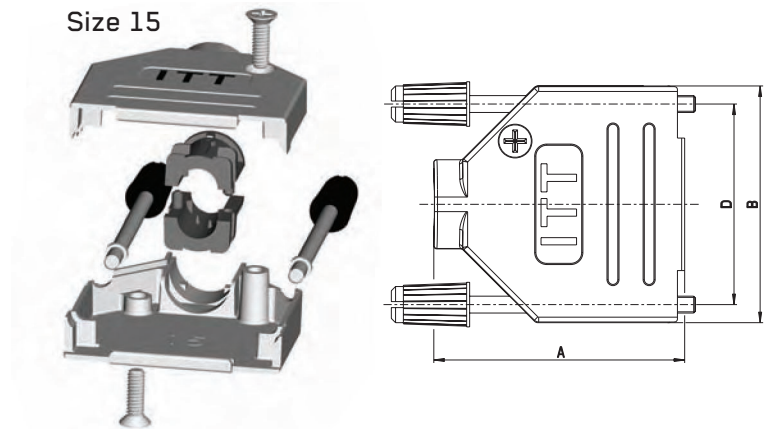

Part Description With #4-40 UNC Jackscrew	Part Description With M3 Jackscrew	Shell Size	A	B	C	D	Cable Diameter
DEFME-101	DEFMX-101	Size 9	39,55mm [1.555inch]	31,3mm [1.232inch]	14,6mm [0.575inch]	25,0mm [0.984inch]	4 - 9mm
DAFME-101	DAFMX-101	Size 15	41,7mm [1.642inch]	39,3mm [1.547inch]	14,6mm [0.575inch]	33,3mm [1.311inch]	4 - 9mm
DBFME-101	DBFMX-101	Size 25	49,0mm [1.929inch]	53,5mm [2.106inch]	14,6mm [0.575inch]	47,0mm [1.850inch]	4 - 9mm
DCFME-101	DCFMX-101	Size 37	53,3mm [1.098inch]	69,7mm [2.744inch]	14,6mm [0.575inch]	63,5mm [2.500inch]	4 - 9mm

Kit consists of 1 front shell, 1 rear shell, 4 strain reliefs, 2 mounting crosshead screws, and 2 jack screws.

### Assembly instructions Size 9, 15, 25, 37

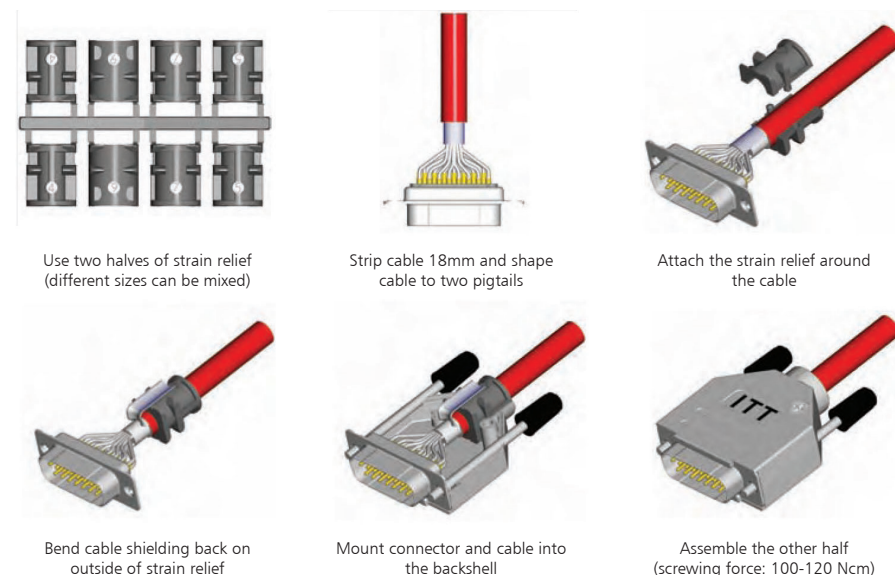

### Attenuation

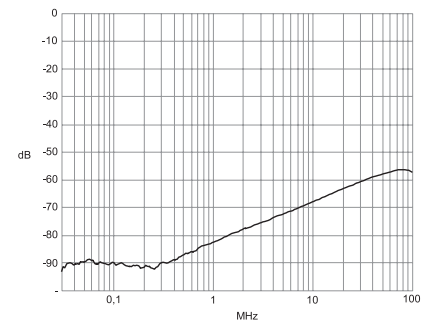

Dimensions shown in mm  
Specifications and dimensions subject to change

## Metal Backshell 45° Exit

D\*FM metal Backshells for D-Subminiature Connectors offers protection from magnetic and radio interferences to cable assemblies.



### Product Features

- No crimp ferrule tooling needed
- Material: Zinc, blue chromated
- Unique metal filled plastic cable strain relief guarantees 360° shielding
- RoHS compliant
- -40 - +120°C temperature range
- Corrosion resistant

Size 15

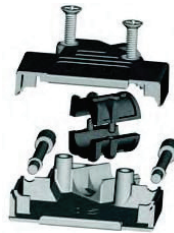

Size 50

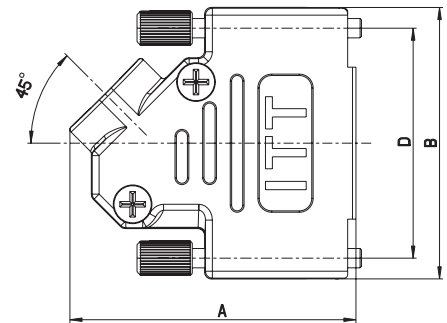
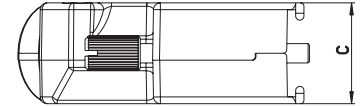
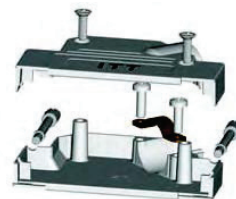

Part Description With #4-40 UNC Jackscrew	Part Description With M3 Jackscrew	Shell Size	A	B	C	D	Cable Diameter
DEFME-100	DEFMX-100	Size 9*	37,5mm [1.476inch]	35,5mm [1.398inch]	14,6mm [0.575inch]		4 - 9mm
DAFME-100	DEFMX-100	Size 15**	41,5mm [1.634inch]	39,5mm [1.555inch]	14,6mm [0.575inch]	33,3mm [1.311inch]	4 - 9mm
DBFME-100	DBFMX-100	Size 25**	41,5mm [1.634inch]	53,5mm [2.106inch]	14,5mm [0.571inch]	47,0mm [1.850inch]	4 - 9mm
DCFME-100	DCFMX-100	Size 37**	41,5mm [1.634inch]	70,0mm [2.756inch]	14,5mm [0.571inch]	63,5mm [2.500inch]	4 - 9mm
DDFME-100	DDFMX-100	Size 50***	45,0mm [1.772inch]	67,5mm [2.657inch]	17,4mm [0.69inch]	61,0mm [2.402inch]	13-16mm

\*Size 9 Backshell: Kit consists of 1 front shell, 1 rear shell, 4 strain reliefs, 2 mounting crosshead screws, 1 jack screw

\*\*Size 15, 25, 37 Backshell: Kit consists of 1 front shell, 1 rear shell, 4 strain reliefs, 2 mounting crosshead screws, 2 jack screws

\*\*\*Size 50 Backshell: Kit consists of 1 front shell, 1 rear shell, 1 cable clamp, 4 mounting crosshead screws, 2 jack screws

### Assembly instructions Size 9, 15, 25, 37

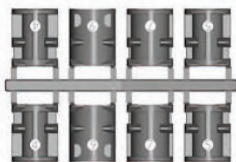

Use two halves of strain relief (different sizes can be mixed)

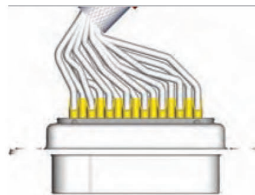

Strip cable 18mm and shape cable to two pigtails



Attach the strain relief around the cable

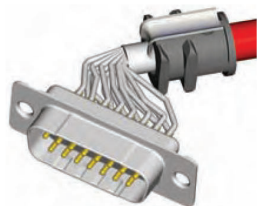

Bend cable shielding back on outside of strain relief

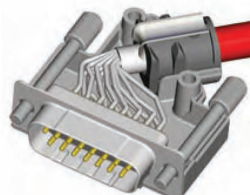

Mount connector and cable into the backshell



Assemble the other half (screwing force: 100-120 Ncm)

### Attenuation

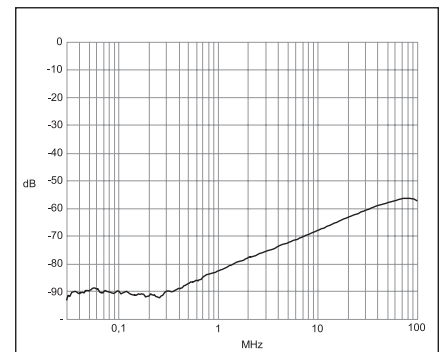

Dimensions shown in mm  
Specifications and dimensions subject to change

www.ittcannon.com

## Metal Backshell

Metal Backshells provide strain relief.  
Various profiles available for different cable routing requirements.

Materials and Finishes	
Backshell Material:	Low Carbon Steel or Brass
Backshell Finish:	Chromate over Cadmium (Mil Spec) or Zinc (RoHS)
Hardware Material:	Steel or brass

### Product Features

- Qualified to MIL-Spec M85049

## Deep Straight Clamp

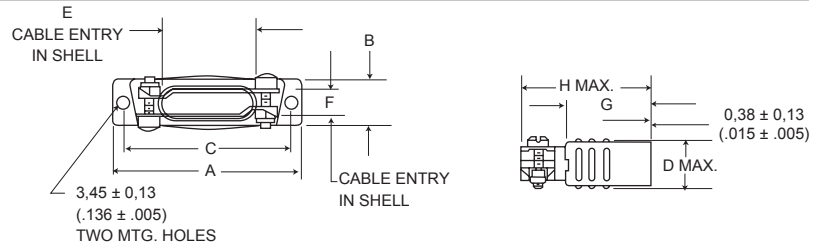

- Kit consists of 1 shell, 2 cable clamps (clamps not displayed), 2 screws, 2 hex nuts.

Shell Size	RoHS Compliant Part Number	Mil-Spec Parts (Brass)		Brass
		Mil-Spec Part Number	Part Number	50 $\mu$ in. Gold over Copper
DE	DE24657-29	M85049/48-1-6F	DE24657-5	DE24657-16
DA	DA24658-28	M85049/48-1-7F	DA24658-2	DA24658-15
DB	DB24659-27	M85049/48-1-8F	DB24659-2	DB24659-15
DC	DC24660-27	M85049/48-1-9F	DC24660-11	DC24660-16
DD	DD24661-27	M85049/48-1-10F	DD24661-4	DD24661-13

Shell Size	Layout	Part Number	Mil Spec Part Number*	A $\pm 0.38$ (.015)	B $\pm 0.572$ (.0225)	C $\pm 0.38$ (.015)	D max.	E $\pm 0.38$ (.015)	F $\pm 0.38$ (.015)	G $\pm 0.38$ (.015)	H max.
DE	9	DE24657	M85049/48-1-1F	30,56 (1.203)	12,484 (.4915)	24,99 (.984)	14,68 (.578)	9,53 (.375)	9,53 (.375)	19,05 (.750)	31,75 (1.250)
DA	15	DA24658	M85049/48-1-2F	38,89 (1.531)	12,484 (.4915)	33,32 (1.312)	14,68 (.578)	18,11 (.713)	7,93 (.312)	19,05 (.750)	31,75 (1.250)
DB	25	DB24659	M85049/48-1-3F	52,78 (2.078)	12,484 (.4915)	47,04 (1.852)	14,68 (.578)	25,40 (1.000)	7,93 (.312)	25,40 (1.000)	39,70 (1.563)
DC	37	DC24660	M85049/48-1-4F	69,04 (2.718)	12,484 (.4915)	63,50 (2.500)	14,68 (.578)	34,93 (1.375)	7,93 (.312)	25,40 (1.000)	39,70 (1.563)
DD	50	DD24661	M85049/48-1-5F	66,68 (2.625)	15,253 (.6005)	61,11 (2.406)	17,45 (.578)	35,71 (1.406)	10,31 (.406)	28,57 (1.125)	42,88 (1.688)

\* Parts ordered with no suffix or "Z" suffix will be substituted with "F" suffix.

## Round Cable Clamp

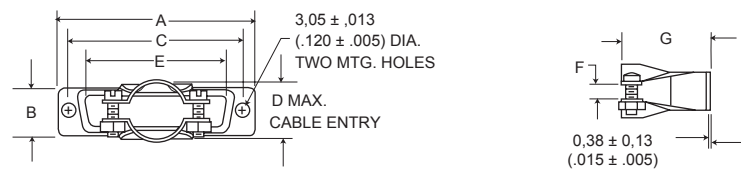

- Kit consists of 1 shell, 2 cable clamps, 2 screws, 2 hex nuts.

Shell Size	RoHS Compliant Part Number	Mil-Spec Parts (Brass)		Brass
		Mil-Spec Part Number	Part Number	50 $\mu$ in. Gold over Copper
DE	DE44994-14	M85049/48-2-6F	DE44994-3	DE44994-2
DA	DA20961-26	M85049/48-2-7F	DA20961-3	DA20961-16
DB	DB20962-30	M85049/48-2-8F	DB20962-8	DB20962-18
DC	DC20963-27	M85049/48-2-9F	DC20963-8	DC20963-17
DD	DD20964-32	M85049/48-2-10F	DD20964-8	DD20964-19

Shell Size	Layout	Part Number	Mil Spec Part Number*	A $\pm 0.38$ (.015)	B $\pm 0.572$ (.0225)	C $\pm 0.38$ (.015)	D max.	E $\pm 0.38$ (.015)	F $\pm 0.38$ (.015)	G $\pm 0.38$ (.015)
DE	9	DE44994	M85049/48-2-1F	30,68 (1.208)	12,70 (.500)	24,99 (.984)	10,31 (.406)	16,79 (.661)	3,18 (.125)	26,18 (1.031)
DA	15	DA20961	M85049/48-2-2F	38,89 (1.531)	12,70 (.500)	33,33 (1.312)	10,31 (.406)	24,99 (.984)	3,18 (.125)	26,18 (1.031)
DB	25	DB20962	M85049/48-2-3F	52,78 (2.078)	12,70 (.500)	47,04 (1.852)	15,06 (.593)	38,48 (1.515)	4,75 (.187)	26,98 (1.062)
DC	37	DC20963	M85049/48-2-4F	69,04 (2.718)	12,70 (.500)	63,50 (2.500)	18,23 (.718)	55,14 (2.171)	6,35 (.250)	26,98 (1.062)
DD	50	DD20964	M85049/48-2-5F	66,68 (2.625)	15,47 (.609)	61,11 (2.406)	20,62 (.812)	53,16 (2.093)	7,92 (.312)	26,98 (1.062)

\* Parts ordered with no suffix or "Z" suffix will be substituted with "F" suffix.

Dimensions shown in mm  
Specifications and dimensions subject to change

## Short Straight Clamp

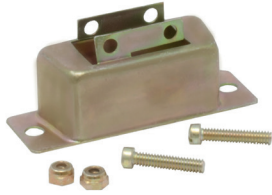

- Kit consists of 1 shell, 2 or 3 screws, 2 or 3 hex nuts

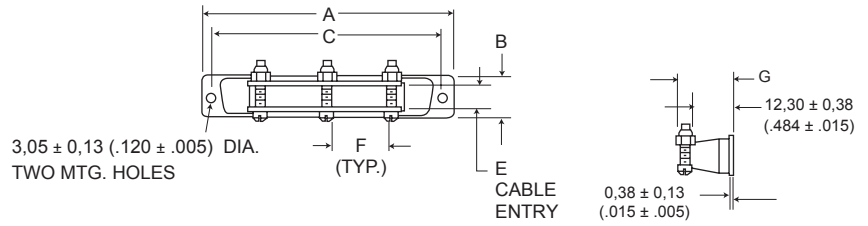

Shell Size	RoHS Compliant Part Number	Mil-Spec Parts (Brass)		Brass
		Mil-Spec Part Number	Part Number	50 $\mu$ in. Gold over Copper
DA	DA19678-212	M85049/48-3-7F	DA19678-38	DA19678-167
DB	DB19678-213	M85049/48-3-8F	DB19678-53	DA19678-168
DC	DC19678-214	M85049/48-3-9F	DC19678-85	DA19678-138
DD	DD19678-214	M85049/48-3-10F	DD19678-55	DA19678-161

Shell Size	Layout	Part Number	Mil Spec Part Number*	No. of Cable Locking Screws Included	A $\pm 0,38 (.015)$	B $\pm 0,38 (.015)$	C $\pm 0,13 (.005)$	E $\pm 0,38 (.015)$	F $\pm 0,38 (.015)$	G $\pm 0,98 (.035)$
DA	15	DA19678-1	M85049/48-3-2F	2	38,88 (1.531)	12,70 (.500)	33,33 (1.312)	7,51 (.296)	7,93 (.312)	16,36 (.644)
DB	25	DB19678-2	M85049/48-3-3F	2	52,78 (2.078)	12,70 (.500)	47,04 (1.852)	7,51 (.296)	20,22 (.796)	16,36 (.644)
DC	37	DC19678-3	M85049/48-3-4F	3	69,04 (2.718)	12,70 (.500)	63,50 (2.500)	7,51 (.296)	17,45 (.687)	16,36 (.644)
DD	50	DD19678-4	M85049/48-3-5F	3	66,68 (2.625)	15,47 (.690)	61,11 (2.406)	9,91 (.390)	17,45 (.687)	17,63 (.694)

\* Parts ordered with no suffix or "Z" suffix will be substituted with "F" suffix.

## 90° Entry

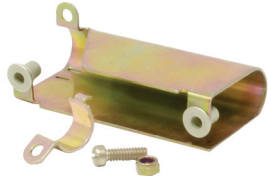

- Kit consists of 1 shell, 1 cable clamp, 1 screw, 1 nut, 2 rivnuts (assembled)

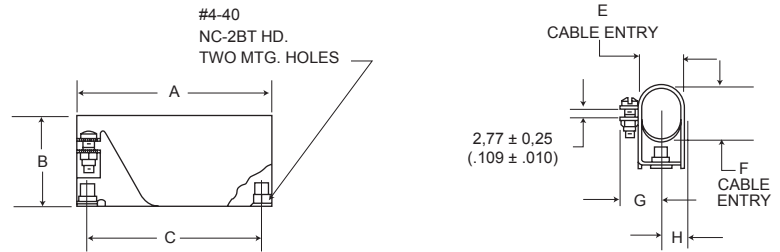

Shell Size	RoHS Compliant Part Number	Mil-Spec Parts (Brass)		Brass
		Mil-Spec Part Number	Part Number	50 $\mu$ in. Gold over Copper
DE	DE19977-72	M85049/50-6F	DE19977-20	DE19977-47
DA	DA19977-68	M85049/50-7F	DA19977-6	DE19977-40
DB	DB19977-69	M85049/50-8F	DB19977-17	DE19977-43
DC	DC19977-70	M85049/50-9F	DC19977-18	DE19977-45
DD	DC19977-71	M85049/50-10F	DD19977-19	DE19977-44

Shell Size	Layout	Part Number	Mil Spec Part Number*	A $\pm 0,38 (.015)$	B $\pm 0,38 (.015)$	C $\pm 0,13 (.005)$	E $\pm 0,38 (.015)$	F $\pm 0,38 (.015)$	G $\pm 0,98 (.035)$	H
DE	9	DE19977-5	M85049/50-1F	30,56 (1.203)	18,24 (.718)	24,99 (.984)	11,10 (.437)	11,10 (.437)	11,89 (.468)	7,14 (.281)
DA	15	DA19977-1	M85049/50-2F	38,89 (1.531)	12,70 (.500)	33,33 (1.312)	11,10 (.437)	11,10 (.437)	11,89 (.468)	7,14 (.281)
DB	25	DB19977-2	M85049/50-3F	52,78 (2.078)	12,70 (.500)	47,04 (1.852)	11,10 (.437)	15,88 (.625)	11,89 (.468)	7,14 (.281)
DC	37	DC19977-3	M85049/50-4F	69,04 (2.718)	12,70 (.500)	63,50 (2.500)	11,10 (.437)	20,63 (.812)	11,89 (.468)	7,14 (.281)
DD	50	DD19977-4	M85049/50-5F	66,68 (2.625)	15,47 (.690)	61,11 (2.406)	14,28 (.562)	23,01 (.906)	13,47 (.531)	8,71 (.343)

\* Parts ordered with no suffix or "Z" suffix will be substituted with "F" suffix.

# Plastic Backshell



## Snap-Together Metalized Plastic

Metalized plastic backshells reduce EMI/RFI emissions. Metalized plastic provides a lightweight solution. Includes integral strain relieving cable clamp.

### Product Features

- Improves conformance to FCC DOC #20780 shielding requirements
- No crimp ferrule tooling needed
- Quick and simple assembly using snap-together design feature
- Non-metalized, non-shielded versions available

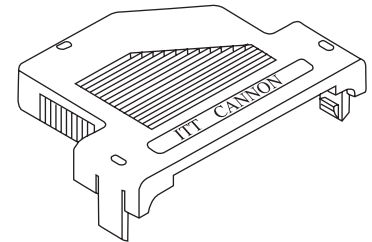
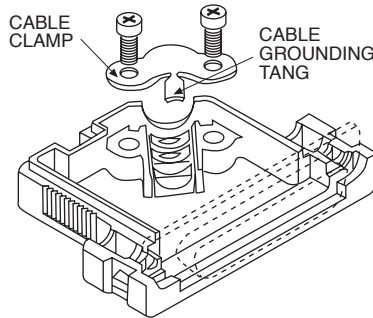

### Attenuation

Note: Cable grounding tang not available on DE size backshell.

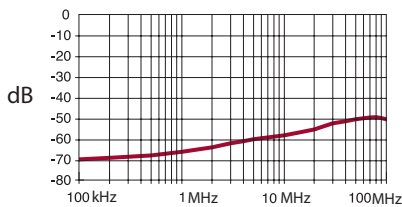

Specifications	
Attenuation:	-49 dB @ 100MHz
Temperature Range:	-20° C to 80° C

Materials and Finishes	
Material:	Thermoplastic, UL 94V-0 rated
Finish:	Nickel over Copper

## Straight Exit



- Kit consists of 1 front shell, 1 rear shell, 1 cable clamp, 2 screws
- Optional locking hardware sold separately, see page 14

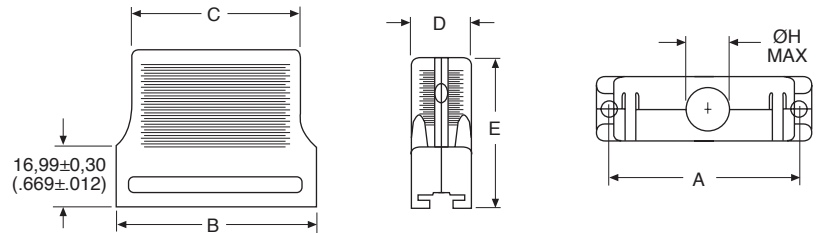

Shell Size	Layout	Computer Cable			Ribbon Cable		A ±0,15 (.006)	B ±0,30 (.012)	C ±0,30 (.012)	D ±0,30 (.120)	E ±0,20 (.008)	ØH Max.
		Shielded	Non-Shielded Gray	Non-Shielded Black	Shielded	Non-Shielded Gray						
DE	9	DE121073-154	DE121073-159	DE121073-259	DE121073-164	DE121073-169	24,95 (.982)	30,81 (1.213)	23,70 (.933)	16,00 (.630)	35,99 (1.417)	7,32 (.288A)
DA	15	DA121073-150	DA121073-155	DA121073-255	DA121073-160	DA121073-165	33,30 (1.311)	39,09 (1.539)	31,80 (1.252)	16,00 (.630)	42,00 (1.654)	8,31 (.327)
DB	25	DB121073-151	DB121073-156	DB121073-256	DB121073-161	DB121073-166	47,00 (1.850)	53,01 (2.087)	45,01 (1.772)	16,00 (.630)	42,00 (1.654)	10,52 (.414)
DC	37	DC121073-152	DC121073-157	DC121073-257	DC121073-162	DC121073-167	63,45 (2.498)	69,29 (2.728)	60,30 (2.374)	16,00 (.630)	42,00 (1.654)	12,32 (.485)
DD	50	DD121073-153	DD121073-158	DD121073-258	-	-	61,10 (2.410)	66,90 (2.634)	58,30 (2.295)	19,00 (.748)	42,00 (1.654)	13,00 (.512)

## 50° Exit



- Kit consists of 1 front shell, 1 rear shell, 1 cable clamp, 2 screws
- Optional locking hardware sold separately, see page 9

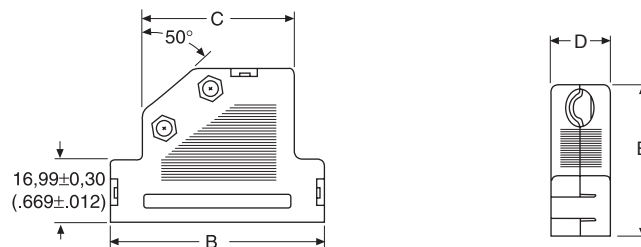

Shell Size	Layout	Shielded Part #	Non-Shielded Part # Gray	B ±0,30 (.012)	C ±0,30 (.012)	D ±0,30 (.012)	E ±0,20 (.008)	Cable Diameter Min.	Cable Diameter Max.
DE	9	DE121073-54	DE121073-59	35,99 (1.417)	22,00 (8.66)	16,00 (.630)	35,99 (1.417)	3,51 (.138)	7,49 (.295)
DA	15	DA121073-50	DA121073-55	44,29 (1.744)	27,31 (1.075)	16,00 (.630)	42,01 (1.654)	6,50 (.256)	8,99 (.354)
DB	25	DB121073-51	DB121073-56	57,99 (2.283)	41,00 (1.614)	16,00 (.630)	42,01 (1.654)	6,50 (.256)	11,00 (.433)
DC	37	DC121073-52	DC121073-57	74,50 (2.933)	57,51 (2.264)	16,00 (.630)	42,01 (1.654)	6,50 (.256)	11,00 (.433)
DD	50	DD121073-53	DD121073-58	72,97 (2.873)	54,99 (2.165)	19,00 (.748)	42,01 (1.654)	8,99 (.354)	13,00 (.512)

Dimensions shown in mm  
Specifications and dimensions subject to change



## Locking Hardware for Snap-Together Plastic Backshell

Recessed Jackscrew

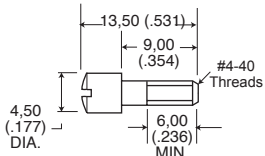

Extended Jackscrew

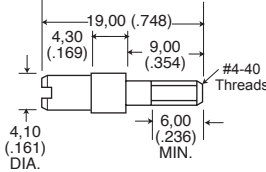
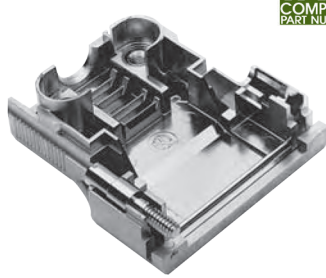

Thumbscrew

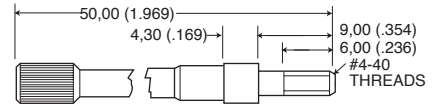
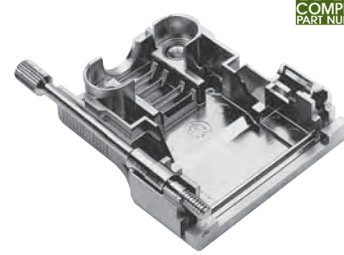

Materials and Finishes			
Part Number	Material	Finish	Quantity Required per Connector
250-8501-004	Brass	Nickel	2
250-8501-009 (M3) ,250-8501-010 (#4-40)	Brass	Nickel	2
250-8501-013	Brass	Nickel	2

## Jackpost for In-Line Connections

Rectangular Nut

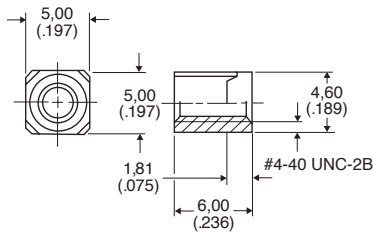

Jackpost

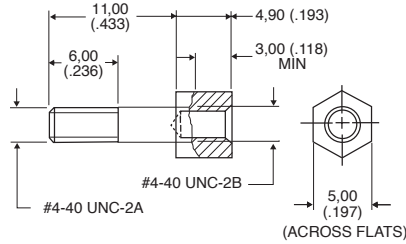

Jackpost Assembly



- Assembly consists of 1 rectangular nut, 1 jackpost, 1 # 4-40 lock washer.

Materials and Finishes			
Part Number	Material	Finish	Quantity Required per Connector
D121073-19	Brass	Nickel	2

## Straight Exit - Metalized Plastic Low Cost

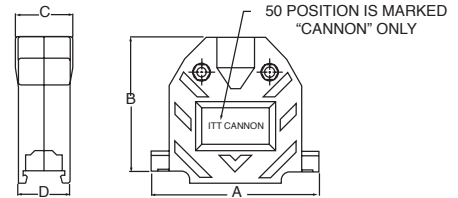
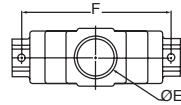
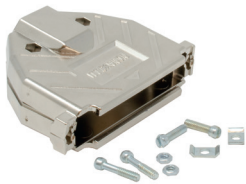

- Kit consists of 1 front shell, 1 rear shell, 1 cable clamp, 2 screws, screw lock assembly kit

Shell Size	Layout	Part Number	A	B	C	D	ø E	F
DE	9	980-2000-350	30,91 (1.217)	39,29 (1.547)	16,26 (.640)	16,26 (.640)	10,16 (.400)	24,99 (.984)
DA	15	980-2000-351	39,24 (1.545)	38,23 (1.505)	16,26 (.640)	16,26 (.640)	10,16 (.400)	33,32 (1.312)
DB	25	980-2000-352	53,09 (2.090)	42,04 (1.655)	18,03 (.710)	16,26 (.640)	13,26 (.522)	47,17 (1.857)
DC	37	980-2000-353	69,44 (2.734)	46,48 (1.830)	23,01 (.906)	16,26 (.640)	18,44 (.726)	63,50 (2.500)
DD	50	980-2000-354	67,18 (2.645)	47,12 (1.855)	23,88 (.940)	19,56 (.770)	18,44 (.726)	61,11 (2.406)

Materials and Finishes: Thermoplastic, UL 94V-0 rated, Nickel plated



Dimensions shown in mm  
Specifications and dimensions subject to change

www.ittcannon.com

## Snap-Together Universal



- 2-piece snap-together design for quick assembly.
- Customer furnishes tie-wrap.

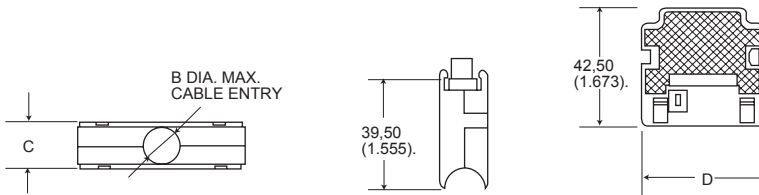

Materials and Finishes	
Material:	Black Thermoplastic, UL 94V-0 rated

Shell Size	Layout	Part Number	øB max.	C ±0,20 (.008)	D ±0,20 (.008)
DE	9	DE115339-20	7,01 (.276)	17,00 (.669)	19,51 (.768)
DA	15	DA115339-21	9,60 (.378)	17,00 (.669)	27,79 (1.094)
DB	25	DB115339-22	11,61 (.457)	17,00 (.669)	41,61 (1.638)
DC	37	DC115339-23	13,00 (.512)	17,00 (.669)	59,99 (2.283)
DD	50	DD115339-24	16,00 (.630)	19,81 (.780)	52,32 (2.060)

Note: Part Numbers above replace the following part number series: DE110963-1 to DD110963-5

## One-Piece Snap-Together



- Low cost, mounting hardware included with 2 thumbscrews, 1 cable clamp

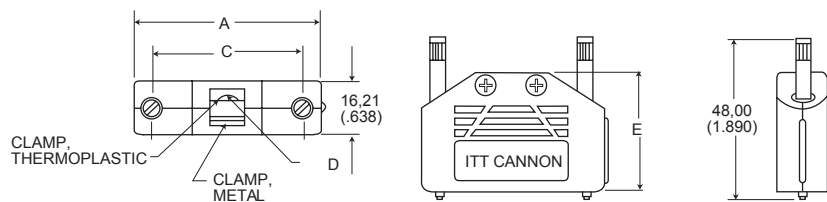

Materials and Finishes	
Backshell Material:	Polypropylene
Hardware Material:	Steel
Hardware Finish:	Black Nickel

Shell Size	Layout	Part Number	A	C	ø D max.	E
DE	9	DEBS-9	35,20 (1.386)	24,99 (.984)	5,69 (.224)	27,51 (1.083)
DA	15	DABS-15	43,31 (1.705)	33,33 (1.312)	5,69 (.224)	31,19 (1.228)
DB	25	DBBS-25	57,20 (2.252)	47,04 (1.852)	6,50 (.256)	38,30 (1.508)
DC	37	DCBS-37	72,00 (2.83)	62,00 (2.44)	7,80 (.307)	43,08 (1.69)
DD	50	DDBS-50	73,70 (2.90)	63,70 (2.50)	8,20 (.322)	48,04 (1.89)

## One-Piece Plastic

### Straight Exit

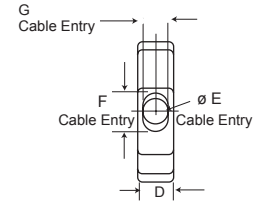
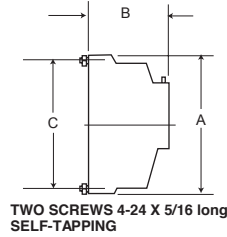

TWO SCREWS 4-24 X 5/16 long SELF-TAPPING

- Kit consists of 1 shell, 1 cable clamp, 1 set screw
- Mounting hardware included
- 2 screws #4-24 x 5/16 long self-tapping
- Accommodates spring latches

Materials and Finishes	
Material:	Black Thermoplastic, UL 94V-0 rated
Hardware Material:	Steel
Hardware Finish:	Chromate over Zinc

Shell Size	Layout	Part Number	A ±0,38 (.015)	B ±0,38 (.015)	C ±0,13 (.005)	D ±0,38 (.015)	ØE ±0,25 (.010)	F ±0,25 (.010)	G ±0,25 (.010)
DE	9	DE51218	30,94 (1.218)	25,40 (1.000)	24,99 (.984)	12,70 (.500)	7,14 (.281)	—	—
DA	15	DA51210	39,27 (1.546)	25,40 (1.000)	33,33 (1.312)	12,70 (.500)	9,14 (.360)	—	—
DB	25	DB51212	53,16 (2.093)	31,75 (1.250)	47,04 (1.852)	12,70 (.500)	—	12,52 (.493)	9,15 (.360)
DC	37	DC51214	69,44 (2.734)	38,10 (1.500)	63,50 (2.500)	12,70 (.500)	—	17,63 (.694)	9,15 (.360)
DD	50	DD51216	67,06 (2.640)	38,10 (1.500)	61,11 (2.406)	15,47 (.690)	—	18,64 (.734)	11,89 (.468)

### 90° Exit

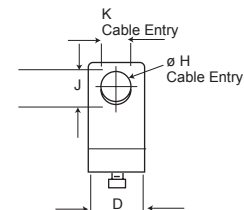
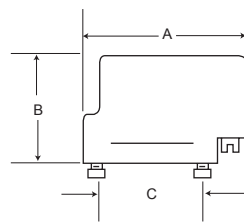

- Kit consists of 1 shell, 1 cable clamp, 1 set screw
- Mounting hardware included
- 2 screws #4-24 x 5/16 long self-tapping

Materials and Finishes	
Material:	Black Thermoplastic, UL 94V-0 rated
Hardware Material:	Steel
Hardware Finish:	Chromate over Zinc

Shell Size	Layout	Part Number	A ±0,38 (.015)	B ±0,38 (.015)	C ±0,13 (.005)	D ±0,38 (.015)	ØH ±0,25 (.010)	J ±0,25 (.010)	K ±0,25 (.010)
DE	9	DE51219	37,95 (1.494)	25,40 (1.000)	24,99 (.984)	12,70 (.500)	7,14 (.281)	—	—
DA	15	DA51211	46,28 (1.822)	25,40 (1.000)	33,33 (1.312)	12,70 (.500)	9,14 (.360)	—	—
DB	25	DB51213	60,15 (2.368)	31,75 (1.250)	47,04 (1.852)	12,70 (.500)	—	12,52 (.493)	9,15 (.360)
DC	37	DC51215	76,43 (3.009)	38,10 (1.500)	63,50 (2.500)	12,70 (.500)	—	17,63 (.694)	9,15 (.360)
DD	50	DD51217	74,04 (2.915)	38,10 (1.500)	61,11 (2.406)	15,47 (.690)	—	18,64 (.734)	11,89 (.468)

# Locking Hardware



## Screw Lock Assemblies

Refer to the accessories selection guide on pages 6-7 for use with Cannon backshells. Male or Female RoHS compliant stainless steel and brass versions are available. Please contact factory for more information.

### Product Features

- Ensures positive mating
- Provides locking and latching for high vibration applications

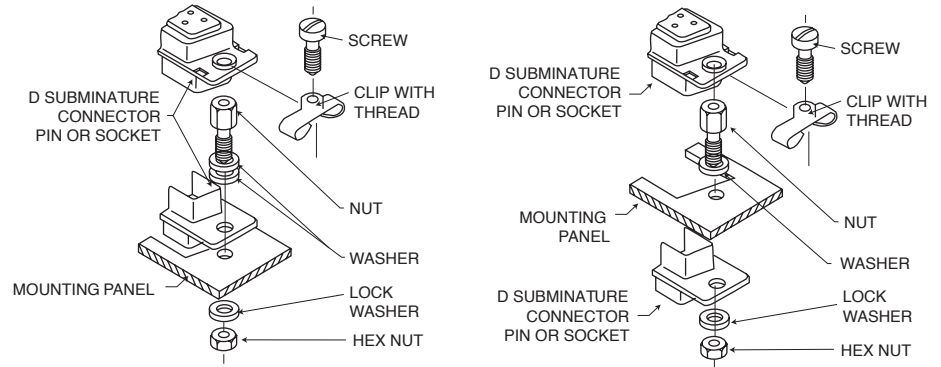

## Male Screw Lock

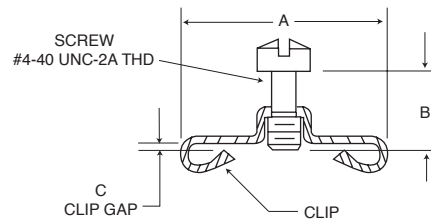

- Kit consists of 1 screw and 1 clip
- Order 2 per connector
- Similar to M24308/25

Materials and Finishes	
Material:	Steel
Finish:	Chromate over Cadmium/Zinc

Shell Size	each P/N Cd	2 each P/N Cd	A ±0,38(.015)	B ±0,2 (.010)	C ±0,13 (.005)	RoHS Compliant P/N each Zn	RoHS Compliant P/N 2 each Zn	Stainless Steel P/N each
DE, DA, DB, DC	D20419	D20419-119	14,10 (.555)	6,35 (.250)	1,22 (.048)	D20419-211	D20419-218	D20419-14
DE, DA, DB, DC	D20419-18	D20419-121	14,10 (.555)	7,14 (.281)	1,70 (.067)	D20419-212	D20419-219	D20419-38
DE, DA, DB, DC	D20419-21	D20419-122	14,10 (.555)	7,14 (.281)	2,34 (.092)	D20419-213	D20419-220	-
DE, DA, DB, DC	D20419-104	D20419-216	14,10 (.555)	7,92 (.312)	2,34 (.092)	D20419-214	D20419-221	-
DD	D20420	D20420-097	16,66 (.656)	6,35 (.250)	1,22 (.048)	D20420-157	D20420-163	D20420-21
DD	D20420-13	D20420-099	16,66 (.656)	7,14 (.281)	1,70 (.067)	D20420-158	D20420-164	D20420-136
DD	D20420-15	D20420-100	16,66 (.656)	7,14 (.281)	2,34 (.092)	D20420-159	D20420-165	D20420-70
DD	D20420-86	D20420-162	16,66 (.656)	7,92 (.312)	2,34 (.092)	D20420-160	D20420-166	-

Dimensions shown in mm  
Specifications and dimensions subject to change



## Female Screw Lock



- Kit consists of 1 nut, 3 washer, 1 lock washer, 1 hex nut.
- Order 2 per connector
- Qualified supplier of M24308/26 female screw locks.

### Front Panel Mount

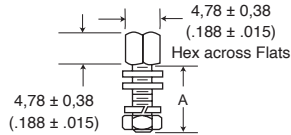

### Rear Panel Mount

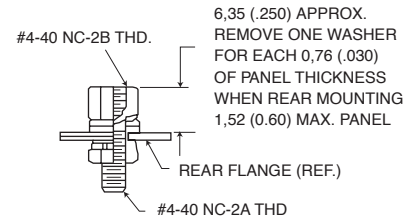

NOTE: (1) A 6 inch/pound (female) and 4 inch/pound (male) maximum torque during assembly is recommended on steel screw lock assemblies. (2) A third flat washer is supplied for front panel mounting of tab shell connectors.

Materials and Finishes	
Material:	Steel
Finish:	Chromate over Cadmium (Mil Spec) or Zinc (RoHS)

Yellow Chromate over cadmium each	Over Cadmium Kit of 2 each	Yellow Chromate over zinc each	RoHS Compliant Part Number	A ± 0,38 (.015)	Mil-Spec Part Number Ref	Stainless Steel Part Number
D20418-2	D20418-82	D20418-128	D20418-134	7,92 (.312)	M24308/26-1	D20418-14 REF
D20418-50	D20418-131	-	D20418-135	12,70 (.500)	-	D20418-102
D20418-39	D20418-83	D20418-129	D20418-136	15,88 (.625)	M24308/26-2	D20418-77 REF
D20418-74	D20418-132	-	D20418-137	19,05 (.750)	-	-

## Screw Locks for Connectors with Integral Threaded Inserts

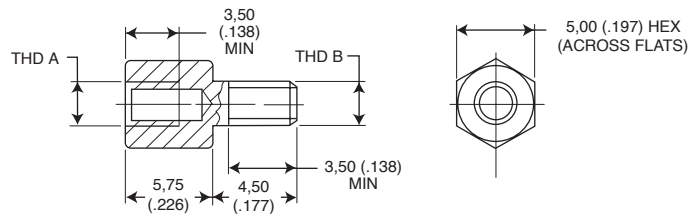
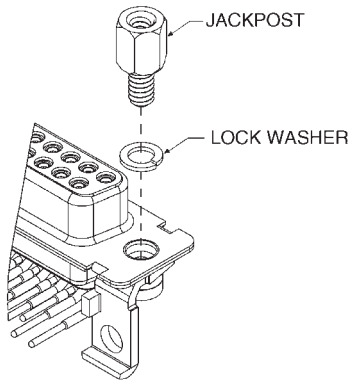

- Kit consists of 1 jackpost, 1 lock washer.
- Order 2 per connector.

Part Number	Thread Type	
	THD A	THD B
D121073-39	# 4-40 UNC-2B	# 4-40 UNC-2A
D112041 *	# 4-40 UNC-2B	# 4-40 UNC-2A
D121073-42	M3	M3

## Loose Spacer

Part Number: 253-0343-000 (D\*M Style)  
 Part Number: 253-0343-011 (D\*MA Style)  
 Part Number: 253-0343-016 (D\*MA Style) St. Stl.

Dim A  
 5.84 ± .08 (.230 ± .003)  
 9.40 ± .13 (.370 ± .005)  
 9,40 +/- 0,13 (.370 +/- .005)

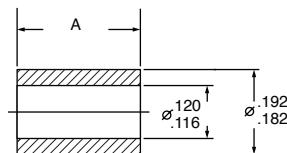

Materials and Finishes	
Material:	Aluminum
Finish:	Chromate over Cadmium

RoHS compliant stainless steel and brass versions are available, please contact factory for more information.



Dimensions shown in mm  
 Specifications and dimensions subject to change

www.ittcannon.com

## Slide Lock Assemblies

ITT offers the largest variety of locking and latching hardware. Refer to the accessories selection guide on pages 6-7 for use with Cannon backshells.

### Product Features

- Ensures positive mating
- Provides locking and latching for high vibration applications

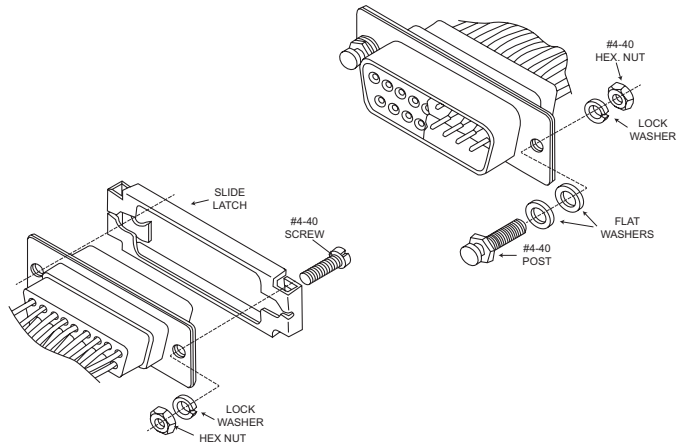

## Sliding Lock Retainer Assembly



- Kit consists of 1 sliding lock plate, 2 mounting screws, 2 lock washer, 2 hex nuts
- Order 1 kit per connector

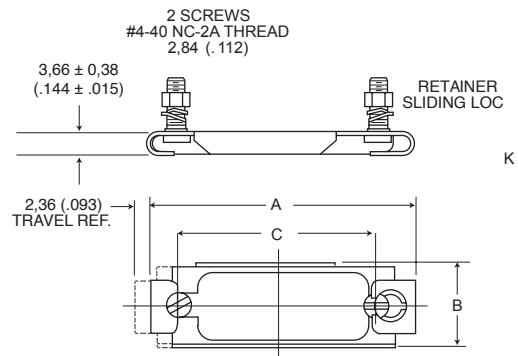

Descriptions	Material	Finish/Treatment
Sliding Lock Plate	Stainless Steel	Passivated
Screw, Mounting	Steel	Trivalent Chromate over Zinc
Washer Lock	Steel	
Nut, Hex	Steel	

Shell Size	Layout	Part Number	A ± 0,38 (.015)	B ± 0,38 (.015)	C ± 0,13 (.005)
DE	9	DE51224-1	35,05 (1.380)	12,70 (.500)	25,00 (.984)
DA	15	DA51220-1	43,70 (1.720)	12,70 (.500)	33,32 (1.312)
DB	25	DB51221-1	57,40 (2.260)	12,70 (.500)	47,04 (1.852)
DC	37	DC51222-1	73,86 (2.908)	12,70 (.500)	63,50 (2.500)
DD	50	DD51223-1	71,47 (2.814)	15,47 (.609)	61,11 (2.406)

## Slide Lock Post Assemblies



- Consists of 1 post, 2 washers, 1 lock washer, and 1 hex nut.<sup>1</sup>
- Order 2 per connector.<sup>2</sup>

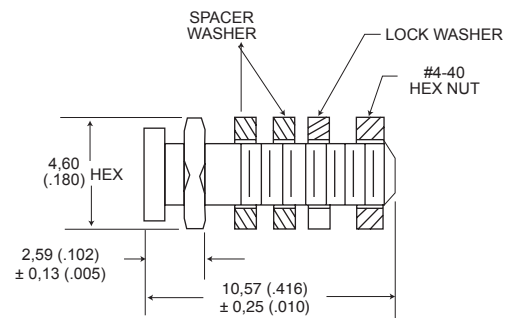

NOTE: When rear-mounting connector to a 1/16" panel, delete the second spacer washer.

\* Not RoHS Compliant.

Part Number:		
Each <sup>1,2</sup>	Kit of 2 each	
D53018*	D53018-11*	Material: Steel, Finish: Chromate over Cadmium
D53018-14*	D53018-20*	Material: Stainless Steel, Finish: Passivated
P/N D53018-21	D53018-22	Material: Steel, Finish: Chromate over Zinc

Dimensions shown in mm  
Specifications and dimensions subject to change

## Spring Latch Assemblies

Refer to the accessories selection guide on pages 6-7 for use with Cannon backshells.

### Product Features

- Low Cost
- Minimizes field connection time
- Positive lock between connectors
- Packaged 2 kits per bag

Unlocked



Locked

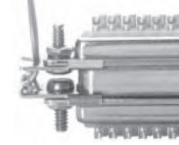

Materials and Finishes	
Material:	Stainless Steel
Finish:	Passivated

## Spring Latch Plate Assembly

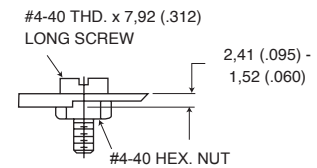
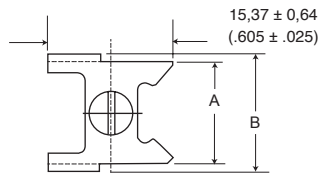
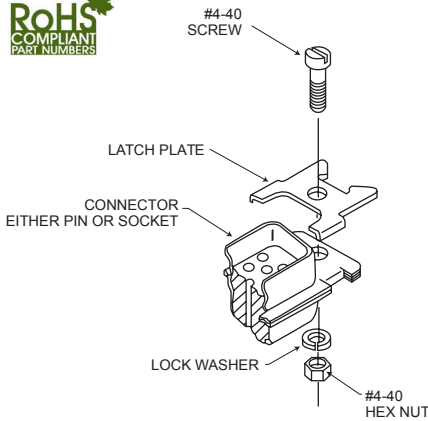

- Kit consists of 1 plate, 1 screw, 1 lock washer, 1 hex nut.
- Order 2 kits per connector.

Shell Size	Layout	Part Number	A ± 0,38 (.015)	B ± 0,38 (.015)	Part Number Kit of 2 each
DE, DA, DB, DC	9,15, 25, 37	D110278	12,42 (.489)	14,35 (.565)	D110278-4
DD	50	D110280	15,47 (.609)	17,09 (.673)	D110280-3

## Spring Latch Assembly

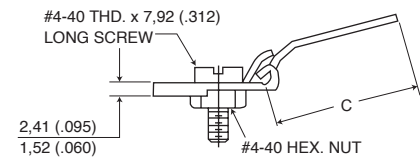
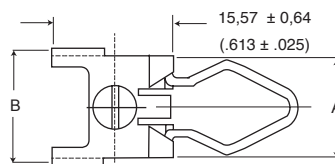
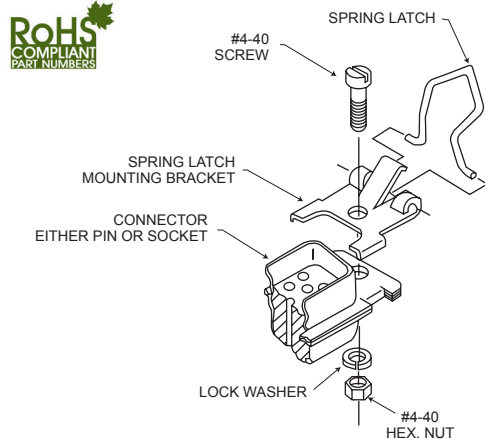

Shell Size	Layout	Part Number	A ± 0,38 (.015)	B ± 0,38 (.015)	C ± 0,51 (.020)	Part Number Kit of 2 each
DE, DA, DB, DC	9,15, 25, 37	D110277	12,42 (.489)	14,35 (.565)	18,59 (.732)	D110277-2
DD	50	D110279	15,47 (.609)	17,09 (.673)	18,59 (.732)	D110279-3

D110277-4 Rear panel mount version also available

- Kit consists of 1 spring, 1 screw, 1 bracket, 1 lock washer, 1 hex nut.
- Order 2 kits per connector. Front panel mounting.



Dimensions shown in mm  
Specifications and dimensions subject to change

www.ittcannon.com

## Jackscrew/Jackpost Assemblies

Refer to the accessories selection guide on pages 6-7 for use with Cannon backshells.

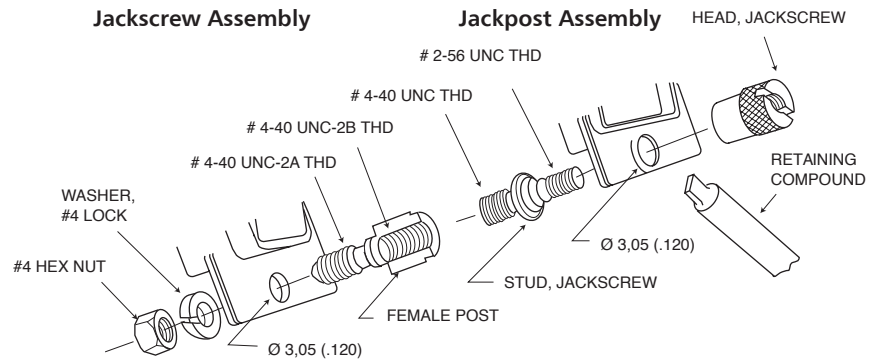

### Jackscrew Assembly



- Kit consists of 2 studs, 2 heads, 1 tube retaining compound (US only)
- Order one kit per connector

Part Number: D110550	
Materials and Finishes	
Material:	Stainless Steel
Treatment:	Passivated

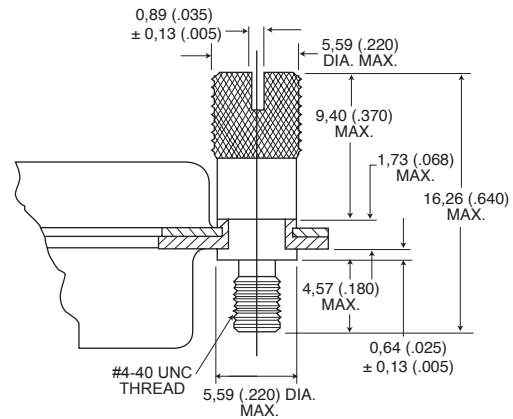

### Jackpost Assembly



- Kit consists of 2 posts, 2 hex nuts, 2 lock washer
- Order one kit per connector

Part Number: D110551	
Materials and Finishes	
Material:	Stainless Steel
Treatment:	Passivated

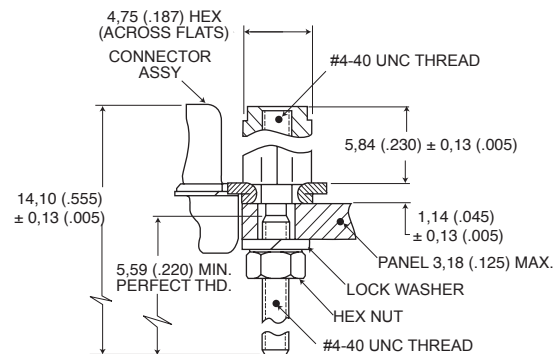

NOTE: Jack post is not compatible with rear-panel mount connectors.

# Guide Pin Plate

## Female



- Useful in blind mate applications.
- Kit consists of 1 plate, 2 screws.
- Guide pin inserts for Size 8 cavities for Combo D® connectors also available. Refer to Combo D catalog.

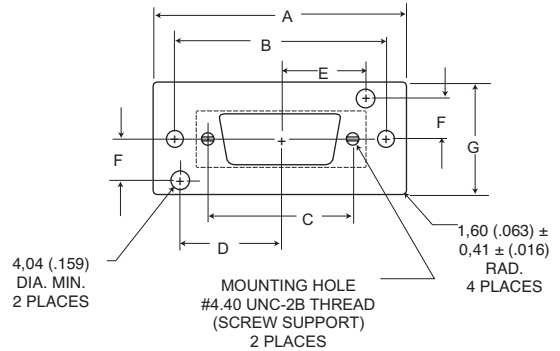
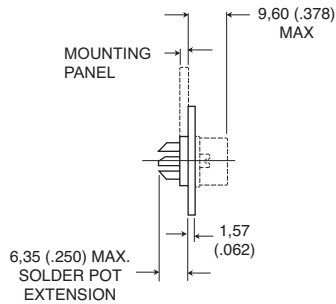

Materials and Finishes	
Plate and Hardware Material:	Steel
Plate and Hardware Finish:	Chromate over Zinc

Shell Size	Layout	Part Number	A ±0,41 (.016)	B ±0,13 (.005)	C ±0,13 (.005)	D ±0,13 (.005)	E ±0,13 (.005)	F ±0,13 (.005)	G ±0,41 (.016)	H ±0,41 (.016)	J ±0,41 (.016)	K ±0,41 (.016)
DE	9	DE111920	49,61 (1.953)	40,08 (1.578)	25,00 (.986)	18,65 (.734)	15,27 (.601)	9,52 (.375)	25,40 (1.000)	30,58 (1.204)	12,29 (.484)	6,15 (.242)
DA	15	DA22214	57,96 (2.282)	48,41 (1.906)	33,32 (1.312)	22,81 (.898)	19,43 (.765)	9,52 (.375)	25,40 (1.000)	38,91 (1.532)	12,29 (.484)	6,15 (.242)
DB	25	DB22254	71,63 (2.820)	62,13 (2.446)	47,04 (1.852)	29,67 (1.168)	26,29 (1.035)	9,52 (.375)	25,40 (1.000)	51,21 (2.016)	11,91 (.469)	5,94 (.234)
DC	37	DC22071	88,11 (3.469)	78,59 (3.094)	63,50 (2.500)	37,90 (1.492)	34,52 (1.359)	9,52 (.375)	25,40 (1.000)	67,49 (2.657)	11,91 (.469)	5,94 (.234)
DD	50	DD21961	85,72 (3.375)	76,20 (3.000)	61,11 (2.406)	36,50 (1.437)	33,32 (1.312)	11,10 (.437)	28,58 (1.125)	65,10 (2.563)	14,30 (.563)	7,16 (.282)

## Recommended Panel Cutout

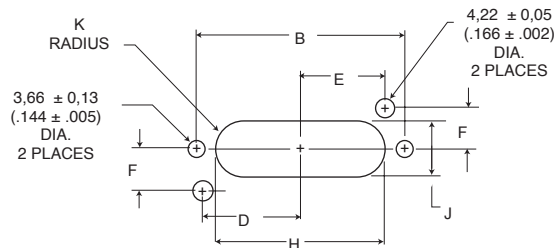

Male



- Useful in blind mate applications.
- Kit consists of 1 plate, 2 screws, 2 rivets, 2 guide pins, 2 washer
- Guide pin inserts for Size 8 cavities for Combo D® connectors also available. Refer to Combo D catalog.

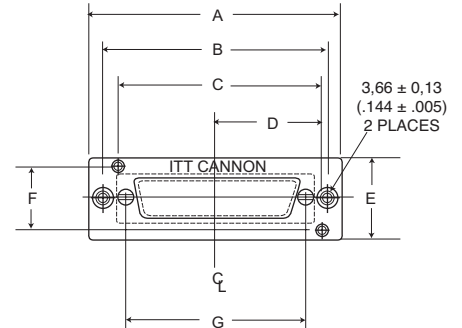
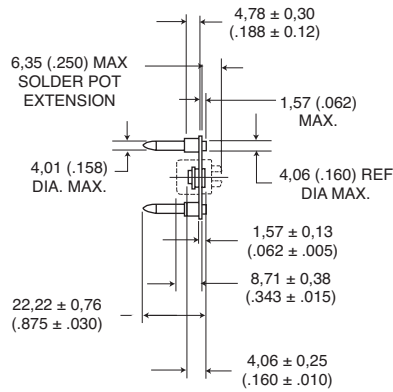

Materials and Finishes	
Plate and Hardware Material:	Steel
Plate and Hardware Finish:	Chromate over Zinc
Guide Pin Material:	Stainless Steel

Shell Size	Layout	Part Number	A ±0,41 (.016)	B ±0,13 (.005)	C ±0,13 (.005)	D ±0,13 (.005)	E ±0,13 (.005)	F ±0,13 (.005)	G ±0,41 (.016)	H ±0,41 (.016)	J ±0,41 (.016)	K ±0,41 (.016)
DE	9	DE111919	49,61 (1.953)	40,08 (1.578)	33,91 (1.335)	18,65 (.734)	25,40 (1.000)	19,05 (.750)	25,00 (.984)	12,29 (.484)	30,58 (1.204)	6,15 (.242)
DA	15	DA22213	57,96 (2.282)	48,41 (1.906)	42,24 (1.663)	22,81 (.898)	25,40 (1.000)	19,05 (.750)	33,32 (1.312)	12,29 (.484)	38,89 (1.531)	6,15 (.242)
DB	25	DB22255	71,63 (2.820)	62,13 (2.446)	55,96 (2.203)	29,67 (1.168)	25,40 (1.000)	19,05 (.750)	47,04 (1.852)	12,29 (.484)	51,99 (2.047)	6,15 (.242)
DC	37	DC22070	88,11 (3.469)	78,59 (3.094)	72,42 (2.851)	37,90 (1.492)	25,40 (1.000)	19,05 (.750)	63,50 (2.500)	12,29 (.484)	68,25 (2.687)	6,15 (.242)
DD	50	DD21962	85,72 (3.375)	76,20 (3.000)	69,82 (2.749)	36,50 (1.437)	28,58 (1.125)	22,20 (.874)	61,11 (2.406)	15,06 (.593)	66,93 (2.635)	7,52 (.296)

Recommended Panel Cutout

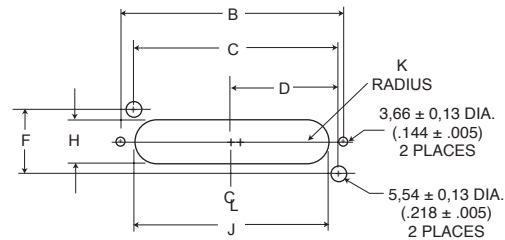

# Connector Saver

## High Reliability Connector Saver



Engaging Face, Pin Side

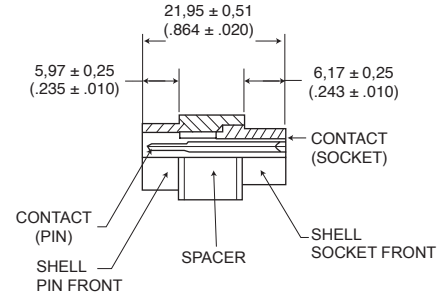
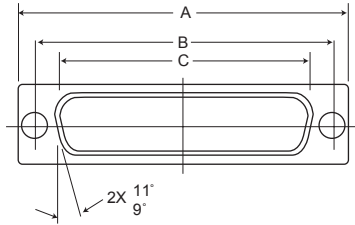

NOTE: Hardware removed for clarity.

Shell Size	Layout	Part Number	A ± 0,40 (.015)	B ± 0,25 (.010)	C ± 0,25 (.010)
DE	9	DEBMAM9PS	30,81 (1.213)	24,99 (.984)	16,92 (.666)
DA	15	DABMAM15PS	39,14 (1.541)	33,32 (1.312)	25,25 (.994)
DB	50	DBBMAM25PS	53,04 (2.088)	47,04 (1.852)	38,96 (1.534)
DC	37	DCBMAM37PS	69,32 (2.729)	63,50 (2.500)	55,42 (2.182)
DD	50	DDBMAM50PS	66,93 (2.635)	61,11 (2.406)	52,81 (2.079)

### Specifications

Temperature:	-55° C to 105° C
Current Rating:	7 A
Dielectric withstanding Voltage:	500 VAC at Sea Level

### Materials and Finishes

Description	Material	Finish
Shells:	Steel	Yellow Chromate over Zinc
Insulator:	White Thermoplastic, UL 94V-0	—
Contacts:	Copper Alloy	Gold Over Copper
Locking Hardware:	Stainless Steel	Passivated

# Miscellaneous



## Polarizing Plates

Material: Black plastic, 94-V-0 rated

Part Number by Shell Size	A	B
DE115398	1.208 (30.7)	0.629 (16)
DA115398-1	1.535 (39.0)	0.629 (16)
DB115398-2	2.082 (52.9)	0.629 (16)
DC115398-3	2.726 (69.2)	0.629 (16)
DD115398-4	2.630 (66.8)	0.749 (19)

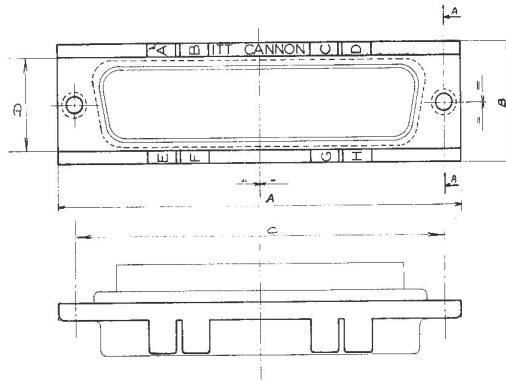

## Polarizing Scheme

Polarizing Keys	A	B	C	D	E	F	G	H
Position 1	○	×	×	○	○	×	×	○
Position 2	×	○	○	×	×	○	○	×
Position 3	○	○	×	×	×	×	○	○
Position 4	×	×	○	○	○	○	×	×
Position 5	×	×	○	○	×	×	○	○
Position 6	○	○	×	×	○	○	×	×
Position 7	×	○	×	○	○	×	○	×
Position 8	○	×	○	×	×	○	×	○
Position 9	×	○	×	○	×	○	×	○
Position 10	○	×	○	×	○	×	○	×

○ Cut Key on pin connector      × Cut Key on socket connector

## Wire Hole Fillers (D\*MA Series Only)

Material: Acetal

Part Number	Insert Type
DMA51236-1	#20 Socket
DMA51235-1	#20 Pin
225-1013-000	#22 Pin & Socket

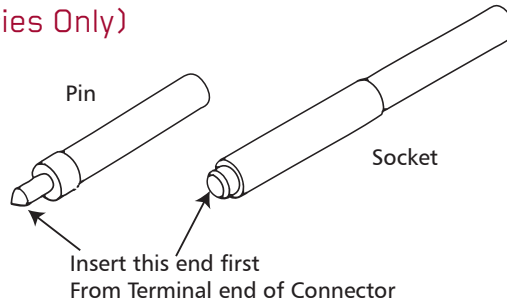

## M24308 Qualified Coupling Hardware

ITT Cannon is a qualified supplier of M24308/25 and M24308/26 Coupling Hardware

M24308/25
M24308/25-9Z
M24308/25-10Z
M24308/25-9F
M24308/25-10F
M24308/25-9P

M24308/26
M24308/26-1F
M24308/26-2F
M24308/26-1P
M24308/26-1Z
M24308/26-2Z
M24308/26-2P

Dimensions shown in mm  
Specifications and dimensions subject to change

www.ittcannon.com



## Dust Cap

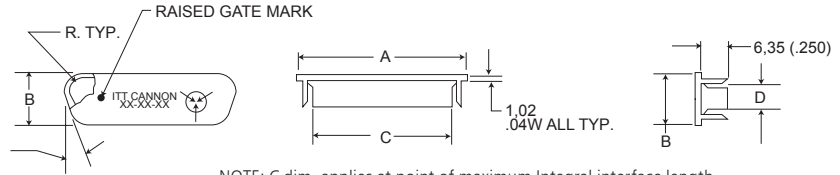

NOTE: C dim. applies at point of maximum Integral interface length.  
Drawing shown for Black Anti-static caps. Dimensions shown are reference only.

Dust caps provide protection from moisture and dust for unused I/O ports.

### Product Features

- Dust Caps meet the static decay test requirements of MIL-B- 81705C, Type II.
- Dust Caps have an integral flange for easy application and removal

Black Antistatic (Surface Resistivity <1x10 <sup>5</sup> ohm/sq.)	I.D.	A	B	C	D
DE-59-20BA	Socket	20,32 (.800)	11,43 (.450)	16,36 (.644)	7,59 (2.99)
DA-59-20BA	Socket	28,45 (1.120)	11,68 (.460)	24,59 (.968)	7,62 (.300)
DB-59-20BA	Socket	42,42 (1.670)	11,68 (.460)	38,25 (1.506)	7,49 (.295)
DC-59-20BA	Socket	58,93 (2.320)	11,68 (.460)	54,81 (2.158)	7,37 (.290)
DD-59-20BA	Socket	56,90 (2.240)	14,48 (.570)	53,11 (2.091)	10,41 (.410)
DE-60-20BA	Pin	21,84 (.860)	12,95 (5.10)	17,78 (.700)	8,92 (.351)
DA-60-20BA	Pin	30,48 (1.200)	12,95 (.510)	26,52 (1.044)	9,02 (.355)
DB-60-20BA	Pin	44,20 (1.740)	13,46 (.530)	39,60 (1.559)	9,09 (.358)
DC-60-20BA	Pin	60,71 (2.390)	13,46 (.530)	56,90 (2.240)	9,37 (.369)
DD-60-20BA	Pin	58,17 (2.290)	16,00 (.630)	54,28 (2.137)	12,04 (.474)

Materials and Finishes	
Material:	Polyethylene

## Interfacial Seal

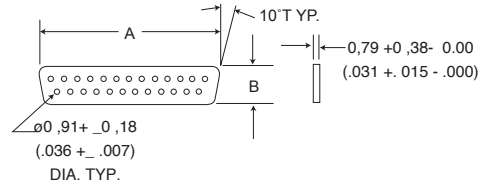

Interfacial seals provide moisture resistance at the mating interface.

### Product Features

- Other Interfacial Seals in the Combo D<sup>®</sup> layouts are available upon request.

Shell Size	Layout	Part Number	A	B
DE	9	DE53750	16,66 (.656)	8,41 (.331)
DA	15	DA53750-1	24,99 (.984)	8,41 (.331)
DB	25	DB53750-2	38,88 1.531)	8,41 (.331)
DC	37	DC53750-3	55,14 (2.171)	8,41 (.331)
DD	50	DD53750-4	52,78 (2.078)	11,18 mm (.440)
DC	21WA4	075-0354-003	55,14 (2.171)	8,41 (.331)
DE	15	273-0333-000	16,66 (.656)	8,41 (.331)
DB	44	273-0335-000	38,88 1.531)	8,41 (.331)
DC	62	273-0336-000	55,14 (2.171)	8,41 (.331)
DD	78	273-0337-000	52,78 (2.078)	11,10 (.437)

Materials and Finishes	
Material:	Silastic Sheet

## Potting Shell

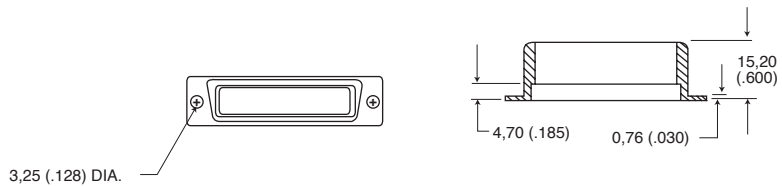

Potting shells are molded with a thin flange 0,76 (.030) to permit the use of D Subminiature locking devices.

Shell Size	Layout	Part Number
DE	9	DE50904-1
DA	15	DA50905-1
DB	25	DB50906-1
DC	37	DC50907-1
DD	50	DD50908-1

Materials and Finishes	
Material:	Nylon
Color:	Natural (white)



Dimensions shown in mm  
Specifications and dimensions subject to change

www.ittcannon.com

# Index



Standard RoHS Part #	Part #	Page #	Standard RoHS Part #	Part #	Page #	Standard RoHS Part #	Part #	Page #
075-0354-003	Same	26	DA22214	Same	22	DD115339-24	Same	15
250-8501-004	Same	14	DA24658	DA24658-28	11	DD121073-153	Same	13
250-8501-009	Same	14	DA50905-1	Same	26	DD121073-53	Same	13
250-8501-010	Same	14	DA51210	Same	16	DD19678-4	Same	12
250-8501-013	Same	14	DA51211	Same	16	DD19977-4	Same	12
273-0333-000	Same	26	DA51220-1	Same	19	DD20964	DD20964-32	11
273-0334-000	Same	26	DA53750-1	Same	26	DD21961	Same	22
273-0335-000	Same	26	DA-59-20	Same	26	DD21962	Same	23
273-0336-000	Same	26	DA-60-20	Same	26	DD24661	Same	11
273-0337-000	Same	26	DABMAM15S	Same	24	DD50908-1	Same	26
980-2000-345	Same	8	DABS-15	Same	15	DD51216	Same	16
980-2000-346	Same	8	DB115339-22	Same	15	DD51217	Same	16
980-2000-347	Same	8	DB115398-2	Same	25	DD51223-1	Same	19
980-2000-348	Same	8	DB121073-151	Same	13	DD53750-4	Same	26
980-2000-350	Same	14	DB121073-51	Same	13	DD-59-20	Same	26
980-2000-351	Same	14	DB19678-2	DB19678-213	12	DD-60-20	Same	26
980-2000-352	Same	14	DB19977-2	DB19977-69	12	DDBMAM50PS	Same	24
980-2000-353	Same	14	DB20962	DB20962-30	11	DE111919	Same	23
980-2000-354	Same	14	DB22254	Same	22	DE111920	Same	22
D110277	Same	20	DB22255	Same	23	DE115339-20	Same	15
D110278	Same	20	DB24659	DB24659-27	11	DE115398	Same	25
D110279	Same	20	DB50906-1	Same	26	DE121073-154	Same	13
D110280	Same	20	DB51212	Same	16	DE121073-54	Same	13
D110550	Same	21	DB51213	Same	16	DE19977-5	DE19977-72	12
D110551	Same	21	DB51221-1	Same	19	DE24657	DE24657-29	11
D121073-19	Same	14	DB53750-2	Same	26	DE44994	DE44994-14	11
D121073-39	Same	18	DB-59-20	Same	26	DE50904-1	Same	26
D121073-42	Same	18	DB-60-20	Same	26	DE51218	Same	16
D20418-2	D20418-134	18	DBMAM25PS	Same	24	DE51219	Same	16
D20418-39	D20418-136	18	DBBS-25	Same	15	DE51224-1	Same	19
D20418-50	D20418-135	18	DC115339-23	Same	15	DE53750	Same	26
D20418-74	D20418-137	18	DC115398-3	Same	25	DE-59-20	Same	26
D20419	D20419-211	17	DC121073-152	Same	13	DE-60-20	Same	26
D20419-104	D20419-214	17	DC121073-52	Same	11	DEBAM9PS	Same	24
D20419-18	D20419-212	17	DC19678-3	DC19678-214	12	DEBS-9	Same	15
D20419-21	D20419-213	17	DC19977-3	DC19977-70	12	DMA 51235-1	Same	25
D20420	D20420-157	17	DC20963	DC20963-27	11	DMA 51236-1	Same	25
D20420-13	D20420-158	17	DC22070	Same	23			
D20420-15	D20420-159	17	DC22071	Same	22			
D20420-86	D20420-160	17	DC24660	Same	11			
D53018	Same	19	DC50907-1	Same	26			
DA115339-21	Same	15	DC51214	Same	16			
DA115398-1	Same	25	DC51215	Same	16			
DA121073-150	Same	13	DC51222-1	Same	19			
DA121073-50	Same	13	DC53750-3	Same	26			
DA19678-1	DA19678-212	13	DC-59-20	Same	26			
DA19977-1	DA19977-68	13	DC-60-20	Same	26			
DA20961	DA20961-26	11	DCBMA37PS	Same	26			
DA22213	Same	23	DD115398-4	Same	25			

Dimensions shown in mm  
Specifications and dimensions subject to change



# D-Subminiature Connectors

Invented by Cannon engineers in 1952 for aircraft radio systems, the D-Subminiature was designed as a smaller, lightweight rectangular alternative to larger, heavier connectors of the time. Today, Cannon continues its legacy of innovation through highly engineered D-Sub connector styles, sizes, configurations and accessories. From rocket launchers and telecommunications, to avionics and high-speed rail, its performance, reliability and versatility have made this Cannon invention one of the most widely used connectors in the world.



## Non-Magnetic Series

D\*M, D\*MM, D\*MA with NM, NMB option connectors are used when non magnetic characteristics are required.



## D\*H

Hermetic Military D connectors are designed to meet environmental conditions of extreme pressure differential.

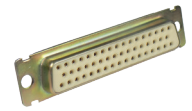

## MIL-DTL-24308<sup>2</sup>

These high reliability D-Sub connectors are the finest quality and are qualified to MIL-DTL-24308.



## D\*MAM

D\*MAM crimp connectors are designed according to MIL-DTL-24308.



## D\*MM

D\*MM straight PCB connectors are designed according to MIL-DTL-24308.

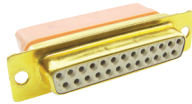

## GD\*

GD\* connectors provide high-density and moisture protection.



## 2D

2D connectors feature double the contact density in the same insert area.

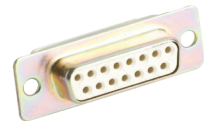

## D\*MA

D\*MA crimp connectors are designed according to MIL-DTL-24308



## D\*M

D\*M straight PCB connectors are equivalent to MIL-DTL-24308 qualified versions (except for finishes).



## Stainless Steel

A broad range of D-Sub connectors are available with stainless steel shells for corrosion resistance.



## D\*NG

D\*NG pressfit connectors provide a low-cost alternative to traditional through hole solder contacts (straight only).

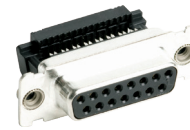

## D\*SF

Speedy D connectors terminate ribbon cables without stripping and without splicing.



## D\*U

D\*U is a low-cost, crimp type D-Subminiature series.



## D\*

D\* connectors are available for high performance uses according to DIN 41652.

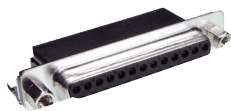

## ZD\*

ZD\* connectors are available for applications where price is the primary driver.

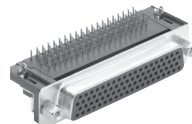

## ZD\*A

ZD\*A high density connectors are available for applications where price is the primary driver.



## D\*A

D\*A crimp connectors are available for applications where price is the primary driver.



## Combo-D

Combo-D connectors offer an industry standard shield I/O interconnect, with the flexibility of a customized special.

ITT is a diversified leading manufacturer of highly engineered critical components and customized technology solutions for the energy, transportation and industrial markets. Building on its heritage of innovation, ITT partners with its customers to deliver enduring solutions to the key industries that underpin our modern way of life. Founded in 1920, ITT is headquartered in White Plains, N.Y., with employees in more than 35 countries and sales in a total of approximately 125 countries. For more information visit [itt.com](http://itt.com)

ITT's Cannon brand offers a product portfolio that remains one of the most extensive in the industry. Continuous investment in technology, research and investment have enabled us to provide new, innovative solutions to markets including:

- **Commercial Aerospace**
- **Military & Defense**
- **Industrial**
- **Medical**

When you specify an ITT Cannon interconnect solution, you can rely on products designed, developed and manufactured to the highest quality and reliability standards. This tradition of excellence is based on ITT's corporate culture of operating its businesses under the principles of Six Sigma. At ITT, Six Sigma is not just a quality philosophy but a complete corporate culture that drives the entire business. Our Value Based Management and Value-Based Product Development systems are two cornerstones that allow for the development of both leadership and product engineering principles.

### Six Sigma Manufacturing

ITT Cannon operates manufacturing facilities in the United States, Germany, Italy, Mexico, China and Japan, all of which have particular product area strengths that allow ITT Cannon to offer a truly global presence to our customers. Our facilities are world class and accommodate full vertical integration, utilizing the latest manufacturing technologies including automated and robotic machining centers, Super Market manufacturing cells, Kanban pull systems, and automated electrical, mechanical, and optical test and inspection equipment. The combination of our manufacturing strength and our advanced manufacturing facilities allows ITT to offer products at market driven prices. Our capabilities, especially in robotics, computerized precision tooling, Kaizen Project Management, Six Sigma tools and testing give ITT the most optimized global manufacturing footprint in the interconnect industry.

### The Custom Difference

As an industry leader in harsh environment interconnect applications, ITT's world class engineering teams work directly with our customers to design and develop cost-effective solutions for their applications. In many cases we may modify one of our standard designs to ensure a highly reliable solution where timing is critical. When custom connectors are required, we collaborate with clients and partners with a goal to design the most reliable, cost-effective solution possible. Our engineering and product management teams provide a thorough analysis of proposed solutions, ensuring our customers receive the right solution for their program and application needs.

### RoHS Compliance Information

ITT has implemented a strict parts control plan for all ITT electronics plants worldwide that allows the Cannon product portfolio to meet the requirements of the European Union Directive 2002/95/EC better known as the Reduction of Hazardous Substances initiative. As appropriate, specific Cannon products may be ordered with an R prefix number which insures our customers will receive RoHS compliant parts for their commercial electronics applications and equipment. Since most RoHS hazardous substances center around specific metal plating and lead solder coatings, ITT's products for RoHS compliance are available in the following plating finishes: electroless nickel, stainless steel, anodize over aluminum and gold plating. It should be noted that gold plating would be recommended as the replacement for tin-lead solder when ordering board mount connectors.



## PRODUCT SAFETY INFORMATION

---

**THIS NOTE MUST BE READ IN CONJUNCTION WITH THE PRODUCT DATA SHEET/CATALOG. FAILURE TO OBSERVE THE ADVICE IN THIS INFORMATION SHEET AND THE OPERATING CONDITIONS SPECIFIED IN THE PRODUCT DATA SHEET/ CATALOG COULD RESULT IN HAZARDOUS SITUATIONS.**

### 1. MATERIAL CONTENT AND PHYSICAL FORM

Electrical connectors do not usually contain hazardous materials. They contain conducting and non-conducting materials and can be divided into two groups.

- a) Printed circuit types and low cost audio types which employ all plastic insulators and casings.
- b) Rugged, Fire Barrier and High Reliability types with metal casings and either natural rubber, synthetic rubber, plastic or glass insulating materials. Contact materials vary with type of connector and also application and are usually manufactured from either: Copper, copper alloys, nickel, alumel, chromel or steel. In special applications, other alloys may be specified.

### 2. FIRE CHARACTERISTICS AND ELECTRIC SHOCK HAZARD

There is no fire hazard when the connector is correctly wired and used within the specified parameters. Incorrect wiring or assembly of the connector or careless use of metal tools or conductive fluids, or transit damage to any of the component parts may cause electric shock or burns. Live circuits must not be broken by separating mated connectors as this may cause arcing, ionization and burning. Heat dissipation is greater at maximum resistance in a circuit. Hot spots may occur when resistance is raised locally by damage, e.g. cracked or deformed contacts, broken strands of wire. Local overheating may also result from the use of the incorrect application tools or from poor quality soldering or slack screw terminals. Overheating may occur if the ratings in the product Data Sheet/Catalog are exceeded and can cause breakdown of insulation and hence electric shock. If heating is allowed to continue it intensifies by further increasing the local resistance through loss of temper of spring contacts, formation of oxide film on contacts and wires and leakage currents through carbonization of insulation and tracking paths. Fire can then result in the presence of combustible materials and this may release noxious fumes. Overheating may not be visually apparent. Burns may result from touching overheated components.

### 3. HANDLING

Care must be taken to avoid damage to any component parts of electrical connectors during installation and use. Although there are normally no sharp edges, care must be taken when handling certain components to avoid injury to fingers. Electrical connectors may be damaged in transit to the customers, and damage may result in creation of hazards. Products should therefore be examined prior to installation/use and rejected if found to be damaged.

### 4. DISPOSAL

Incineration of certain materials may release noxious or even toxic fumes.

### 5. APPLICATION

Connectors with exposed contacts should not be selected for use on the current supply side of an electrical circuit, because an electric shock could result from touching exposed contacts on an unmated connector. Voltages in excess of 30 V ac or 42.5 V dc are potentially hazardous and care should be taken to ensure that such voltages cannot be transmitted in any way to exposed metal parts of the connector body. The connector and wiring should be checked, before making live, to have no damage to metal parts or insulators, no solder blobs, loose strands, conducting lubricants, swarf, or any other undesired conducting particles. Circuit resistance and continuity check should be made to make certain that there are no high resistance joints or spurious conducting paths. Always use the correct application tools as specified in the Data Sheet/Catalog. Do not permit untrained personnel to wire, assemble or tamper with connectors. For operation voltage please see appropriate national regulations.

### IMPORTANT GENERAL INFORMATION

(i) Air and creepage paths/Operating voltage. The admissible operating voltages depend on the individual applications and the valid national and other applicable safety regulations. For this reason the air and creepage path data are only reference values. Observe reduction of air and creepage paths due to PC board and/or harnessing.

#### (ii) Temperature

All information given are temperature limits. The operation temperature depends on the individual application.

#### (iii) Other important information

Cannon continuously endeavors to improve their products. Therefore, Cannon products may deviate from the description, technical data and shape as shown in this catalog and data sheets.

All data subject to change without notice.

cannon

Amazing things  
happen when great  
things connect



Connect with your ITT Cannon representative today  
or visit us at [www.ittcannon.com](http://www.ittcannon.com)

## Connect with the experts

ITT's Cannon brand is a world leader in the design and manufacture of highly engineered connector solutions for multiple end markets.



### Why ITT

ITT is a focused multi-industrial company that designs and manufactures highly engineered critical components and customized technology solutions. ITT's Cannon brand is a leading global manufacturer of connector products serving international customers in aerospace, defense, medical, industrial and transportation end markets. ITT's Connector business, which also includes the Veam and BIW Connector Systems brand, manufactures and supplies a variety of connectors and interconnects that make it possible to transfer data, signal and power in an increasingly connected world.

Connect with your ITT Cannon representative today or visit us at [www.ittcannon.com](http://www.ittcannon.com)

Follow us 

**CHINA - Shenzhen City**  
+86.755.2726.7888

**GERMANY - Weinstadt**  
+49.7151.699.0

**ITALY - Lainate**  
+39.02938721

**KOREA**  
+82.2.702.7111

**SHANGHAI**  
+ 86.21.2231.2222.2

**UK - Basingstoke**  
+44.1256.347400

**FRANCE**  
+33.1.60.04.93.93

**HONG KONG**  
+852.2732.2720

**JAPAN - Kanagawa**  
+81.462.57.2010

**MEXICO - Nogales**  
+52.631.311005

**SINGAPORE**  
+65 66974205

**USA - Irvine, CA**  
+1.800.854.3028

# Mouser Electronics

Authorized Distributor

Click to View Pricing, Inventory, Delivery & Lifecycle Information:

## ITT Cannon:

[M24308/25-10F](#) [M24308/25-10P](#) [M24308/25-10Z](#) [M24308/25-9F](#) [M24308/25-9P](#) [M24308/25-9Z](#) [M24308/26-1P](#)  
[M24308/26-2P](#)

## Looking for pricing, stock, or lifecycle information?

Click below to explore more details on WIN SOURCE:

 [View M24308/25-9Z on WIN SOURCE](#)

 [ITT Cannon, LLC Information](#)

## Optimize Your Supply Chain with WIN SOURCE Solutions

-  Global Sourcing Solution
-  Obsolete Management
-  Cost Control Management
-  Shortage Management
-  Alternative Solution
-  Excess Inventory Management