



**THE DATASHEET OF
PDQ30-Q24-S3-D**



SERIES: PDQ30-D | **DESCRIPTION:** DC-DC CONVERTER

FEATURES

- up to 30 W isolated output
- industry standard 1" x 1" package
- 4:1 input range
- single/dual regulated output
- over voltage, input under voltage lockout, and short circuit protections
- 1,500 Vdc isolation voltage
- five-sided shielded case
- remote on/off control
- output trim
- -40 to 105°C temperature range
- efficiency up to 90%
- EN 62368-1
- meets UL 62368-1

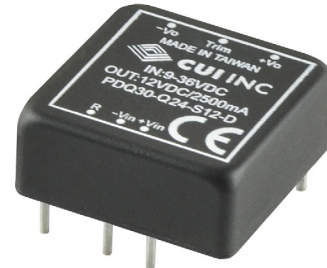

MODEL

MODEL	input voltage		output voltage	output current		output power	ripple & noise ¹	efficiency
	typ (Vdc)	range (Vdc)	(Vdc)	min (A)	max (A)	max (W)	max (mVp-p)	typ (%)
PDQ30-Q24-S3-D	24	9~36	3.3	0	7.5	24.75	75	88
PDQ30-Q24-S5-D	24	9~36	5	0	6.0	30	75	90
PDQ30-Q24-S12-D	24	9~36	12	0	2.5	30	100	89
PDQ30-Q24-S15-D	24	9~36	15	0	2.0	30	100	89
PDQ30-Q24-D12-D	24	9~36	±12	0	±1.25	30	100	88
PDQ30-Q24-D15-D	24	9~36	±15	0	±1.0	30	100	88
PDQ30-Q48-S3-D ³	48	18~75	3.3	0	7.5	24.75	75	88
PDQ30-Q48-S5-D ³	48	18~75	5	0	6.0	30	75	90
PDQ30-Q48-S12-D ³	48	18~75	12	0	2.5	30	100	89
PDQ30-Q48-S15-D ³	48	18~75	15	0	2.0	30	100	89
PDQ30-Q48-D12-D ³	24	18~75	±12	0	±1.25	30	100	88
PDQ30-Q48-D15-D ³	48	18~75	±15	0	±1.0	30	100	89

Notes: 1. At full load, nominal input, 20 MHz bandwidth oscilloscope, with 10 µF tantalum and 1 µF ceramic capacitors on the output.
 2. All specifications are measured at Ta=25°C, nominal input voltage, and rated output load unless otherwise specified.
 3. CE does not apply to 48 Vin models.

PART NUMBER KEY

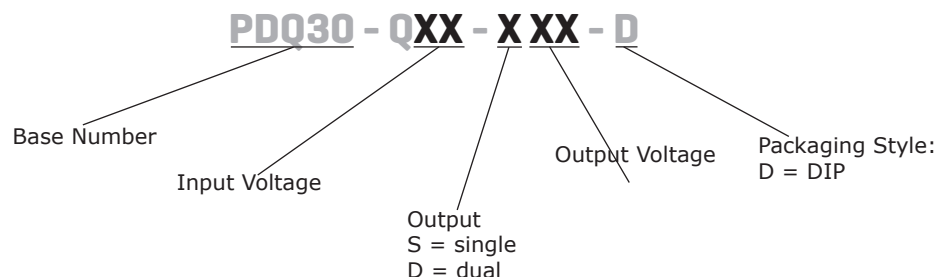

INPUT

parameter	conditions/description	min	typ	max	units
operating input voltage	24 Vdc input models	9	24	36	Vdc
	48 Vdc input models	18	48	75	Vdc
surge voltage	for maximum of 100 ms				
	24 Vdc input models			50	Vdc
	48 Vdc input models			100	Vdc
current	24 Vdc input models			3.9	A
	48 Vdc input models			1.95	A
under voltage shutdown	24 Vdc input models, power up		8.5		Vdc
	24 Vdc input models, power down		8.0		Vdc
	48 Vdc input models, power up		17		Vdc
	48 Vdc input models, power down		16		Vdc
remote on/off ¹	turn on (3.5~75 Vdc or open circuit) turn off (<1.2 Vdc)				
filter	pi filter				
input reverse polarity protection	no				
input fuse	6 A time delay fuse for 24 Vdc input models (recommended)				
	3 A time delay fuse for 48 Vdc input models (recommended)				

Notes: 1. CMOS or open collector TTL, reference to -Vin.

OUTPUT

parameter	conditions/description	min	typ	max	units
maximum capacitive load	3.3 Vdc output models			7,500	μF
	5 Vdc output models			6,000	μF
	12 Vdc output models			2,500	μF
	15 Vdc output models			2,000	μF
	±12 Vdc output models			1,250	μF
	±15 Vdc output models			1,000	μF
voltage accuracy				±1.5	%
line regulation	from high line to low line				
	single output models			±0.2	%
	dual output models			±0.5	%
load regulation	from full load to minimum load				
	single output models			±0.2	%
	dual output models			±1.0	%
voltage balance	dual output models			±1.5	%
cross regulation	load cross variation 10%/100% (dual output models)			±5	%
turn-on delay time, from input	from Vin, min to 10% Vo		10		ms
turn-on delay time, from on/off control	from Von/off to 10% Vo		10		ms
rise time	from 10% Vo to 90% Vo		10		ms
adjustability ²	see application notes		±10		%
switching frequency	3.3, 5 Vdc output models		270		kHz
	all other models		330		kHz
dynamic load response	75%-100% step load change				
	error band (Vout)		5		%
	recovery time		250		μs
temperature coefficient			±0.03		%/°C

Note: 2. For single output models only.

PROTECTIONS

parameter	conditions/description	min	typ	max	units
over voltage protection	zener or TVS clamp				
	3.3 Vdc output models		3.9		Vdc
	5 Vdc output models		6.2		Vdc
	12 Vdc output models (single and dual)		15		Vdc
	15 Vdc output models (single and dual)		18		Vdc
over current protection	hiccup mode	110	140	170	%
short circuit protection	continuous, automatic recovery				
over temperature protection	output shutdown, automatic recovery		110		°C

SAFETY AND COMPLIANCE

parameter	conditions/description	min	typ	max	units
isolation voltage	input to output for 1 minute	1,500			Vdc
isolation resistance	input to output	1,000			MΩ
isolation capacitance	input to output		1,500		pF
safety approvals	62368-1: EN meets 62368-1: UL				
conducted emissions	EN 55022 Class A (external circuit required, see Figure 3)				
RoHS	2011/65/EU				

ENVIRONMENTAL

parameter	conditions/description	min	typ	max	units
operating temperature	see derating curves	-40		105	°C
storage temperature		-55		125	°C
operating humidity	non-condensing			95	%

SOLDERABILITY

parameter	conditions/description	min	typ	max	units
wave soldering	see wave soldering profile			260	°C

- Notes:
1. Soldering materials: Sn/Cu/Ni
 2. Ramp up rate during preheat: 1.4°C/s (from 50°C to 100°C)
 3. Soaking temperature: 0.5°C/s (from 100°C to 130°C), 60±20 seconds
 4. Peak temperature: 260°C, above 250°C for 3~6 seconds
 5. Ramp down rate during cooling: -10°C/s (from 260°C to 150°C)

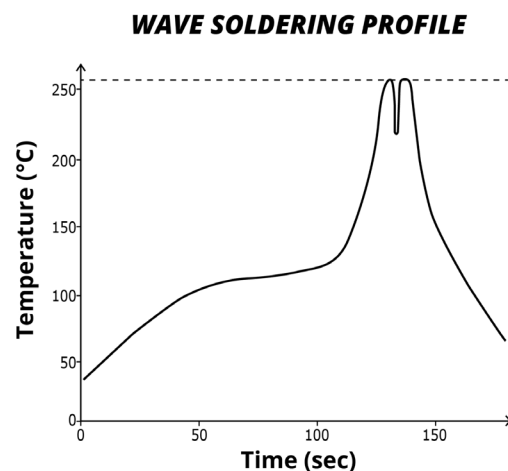

MECHANICAL

parameter	conditions/description	min	typ	max	units
dimensions	1.00 x 1.00 x 0.4 [25.4 x 25.4 x 10.2 mm]				inches
case material	black coated copper with non-conductive base				
weight			18		g

MECHANICAL DRAWING

units: inches [mm]
 tolerance: X.XX ±0.02 [±0.5]
 X.XXX ±0.010 [±0.25]
 pin diameter tolerance: ±0.004[±0.1]

PIN CONNECTIONS		
PIN	Function	
	Single	Dual
1	+Vin	+Vin
2	-Vin	-Vin
3	+Vout	+Vout
4	Trim	Common
5	-Vout	-Vout
6	Remote	Remote

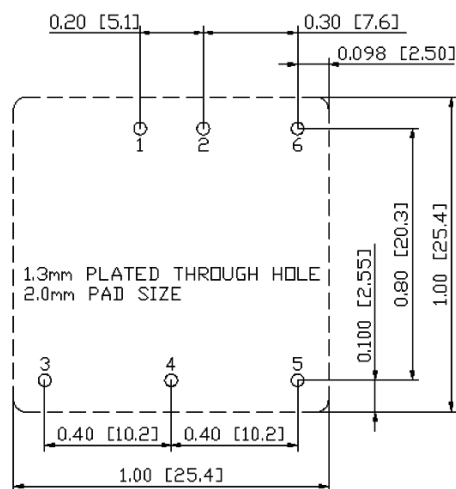
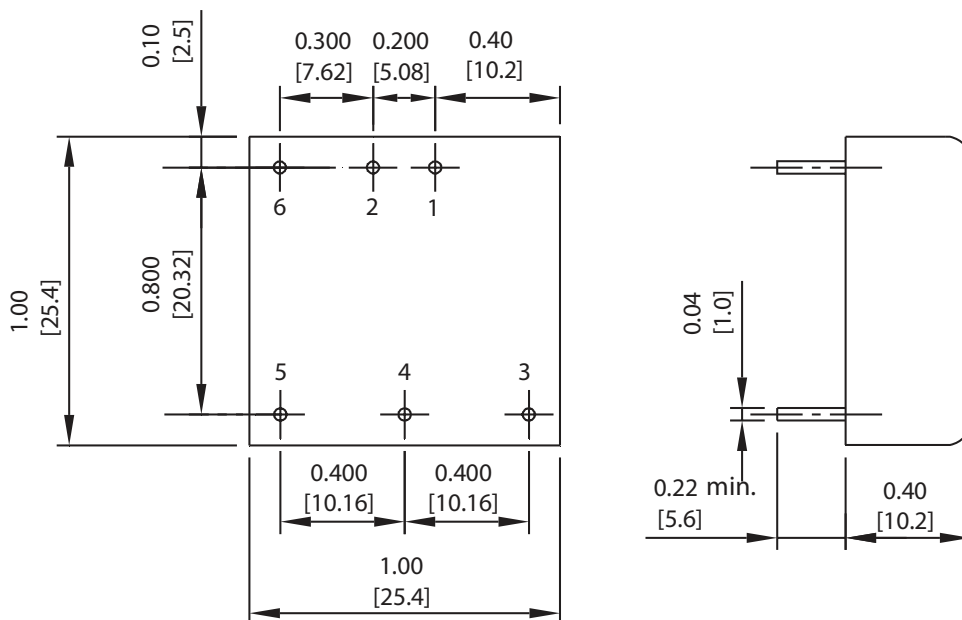

Recommended PCB Layout
Top View

DERATING CURVE

TEMPERATURE DERATING CURVE

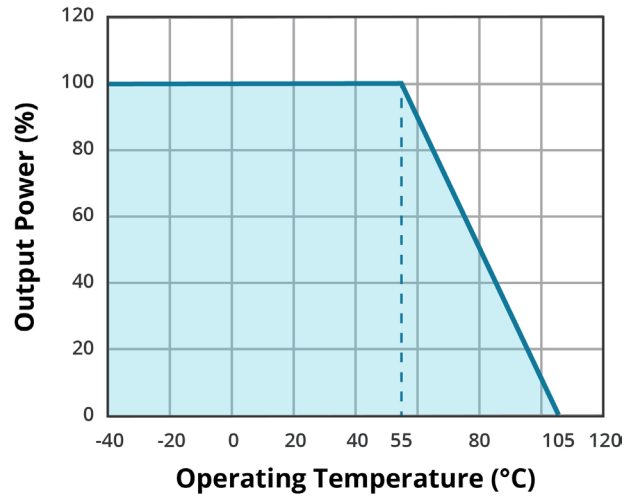

EFFICIENCY CURVES

**EFFICIENCY VS OUTPUT LOAD
PDQ30-Q24-S3-D**

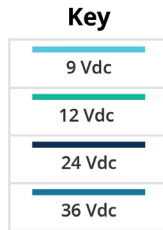
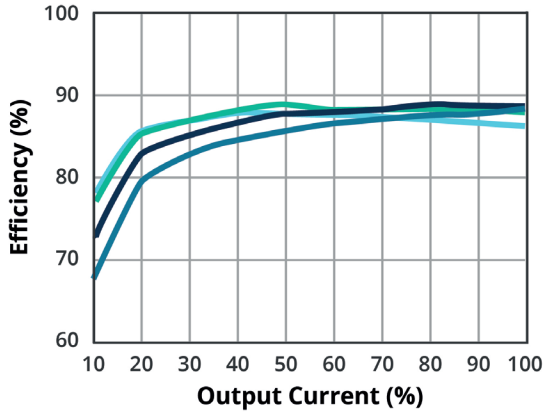

**EFFICIENCY VS OUTPUT LOAD
PDQ30-Q24-S5-D**

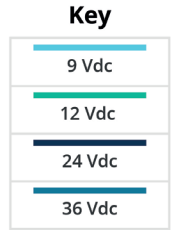
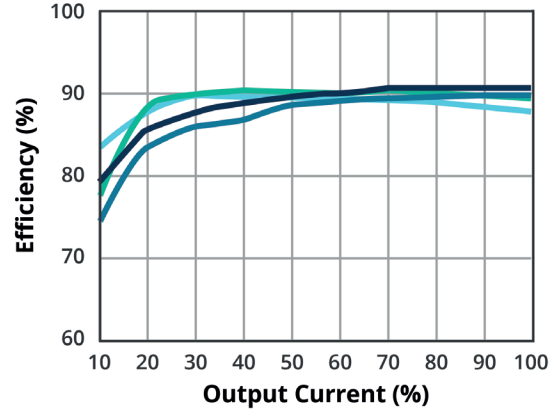

**EFFICIENCY VS OUTPUT LOAD
PDQ30-Q24-S12-D**

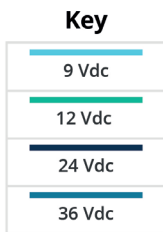
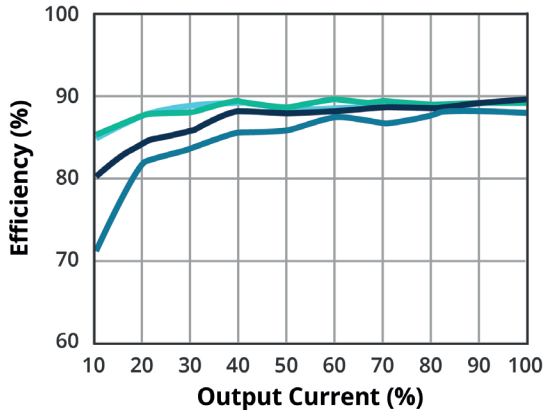

**EFFICIENCY VS OUTPUT LOAD
PDQ30-Q24-S15-D**

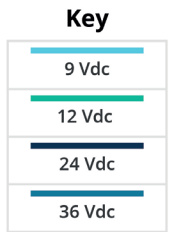
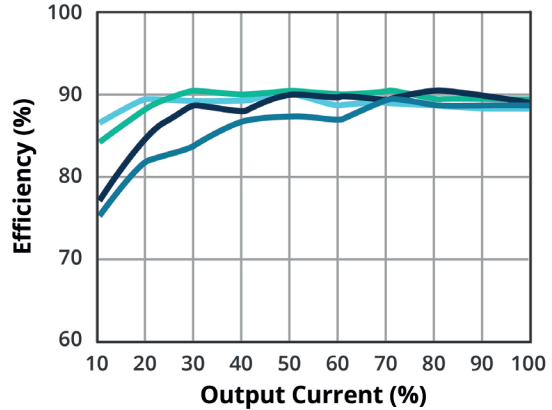

EFFICIENCY CURVES (CONTINUED)

**EFFICIENCY VS OUTPUT LOAD
PDQ30-Q24-D12-D**

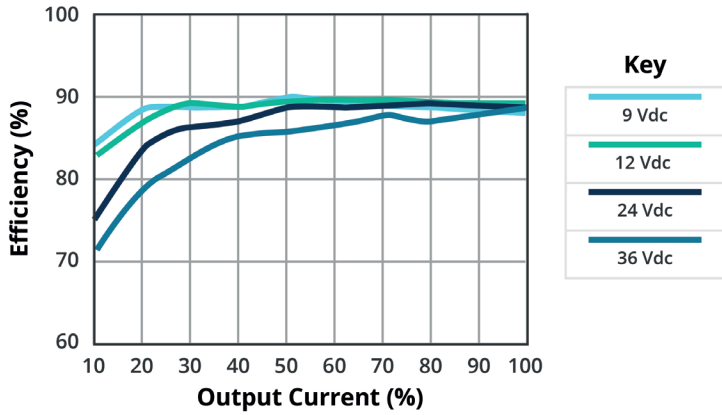

**EFFICIENCY VS OUTPUT LOAD
PDQ30-Q24-D15-D**

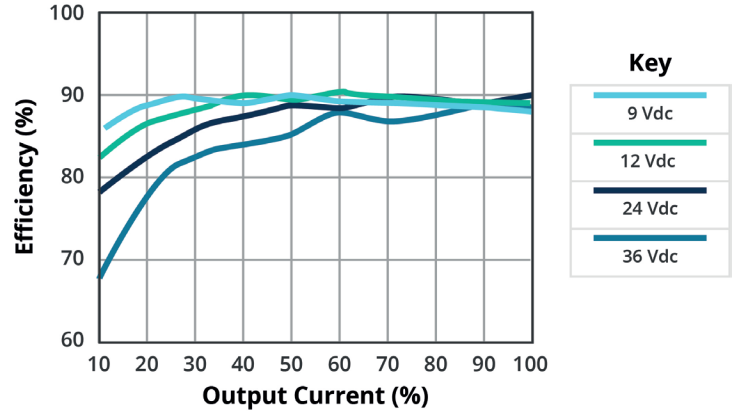

**EFFICIENCY VS OUTPUT LOAD
PDQ30-Q48-S3-D**

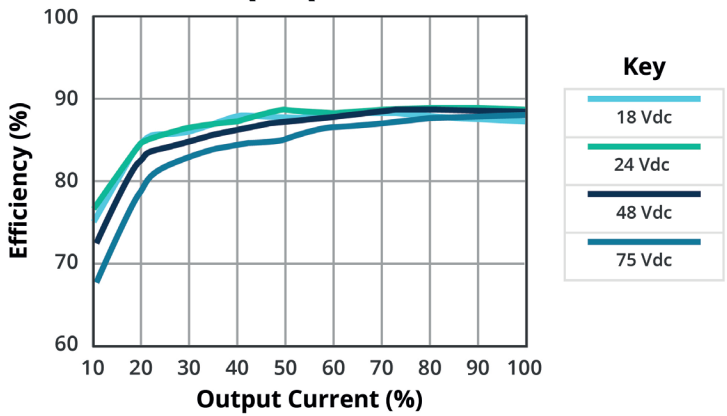

**EFFICIENCY VS OUTPUT LOAD
PDQ30-Q48-S5-D**

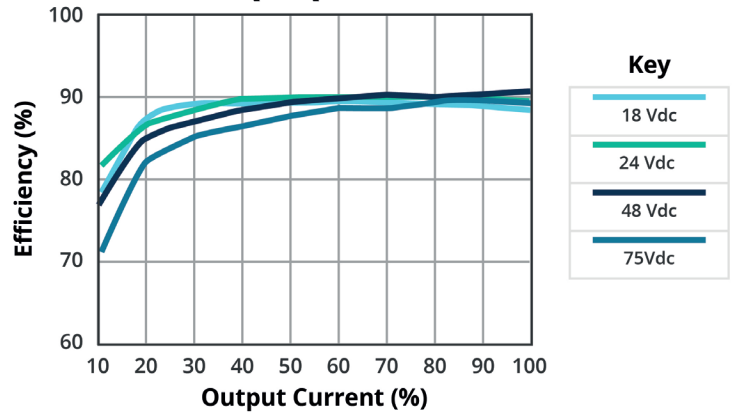

**EFFICIENCY VS OUTPUT LOAD
PDQ30-Q48-S12-D**

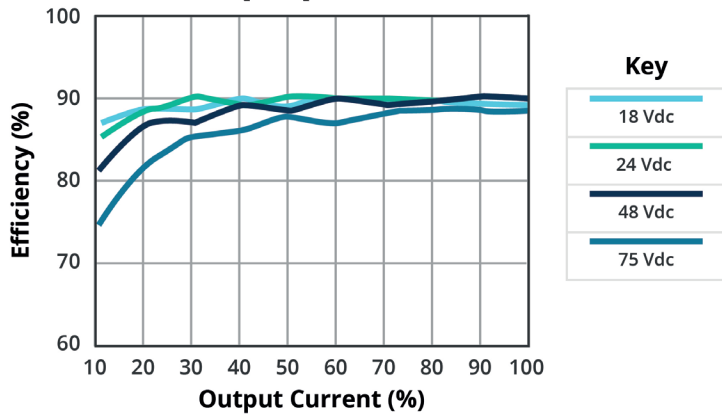

**EFFICIENCY VS OUTPUT LOAD
PDQ30-Q48-S15-D**

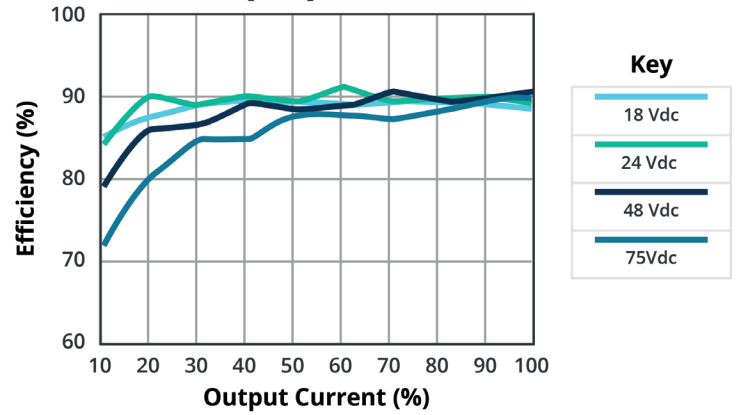

EFFICIENCY CURVES (CONTINUED)

**EFFICIENCY VS OUTPUT LOAD
PDQ30-Q48-D12-D**

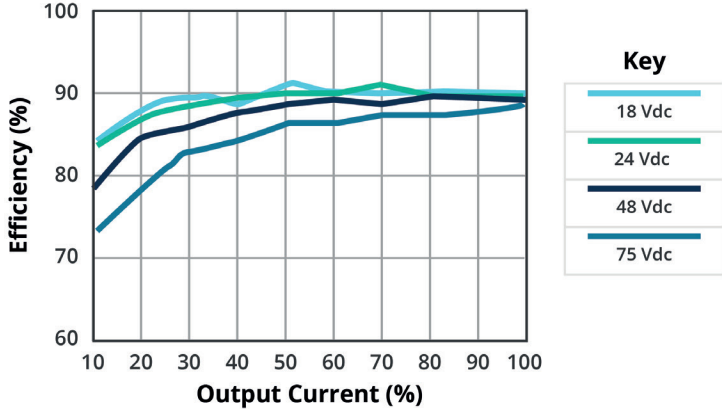

**EFFICIENCY VS OUTPUT LOAD
PDQ30-Q48-D15-D**

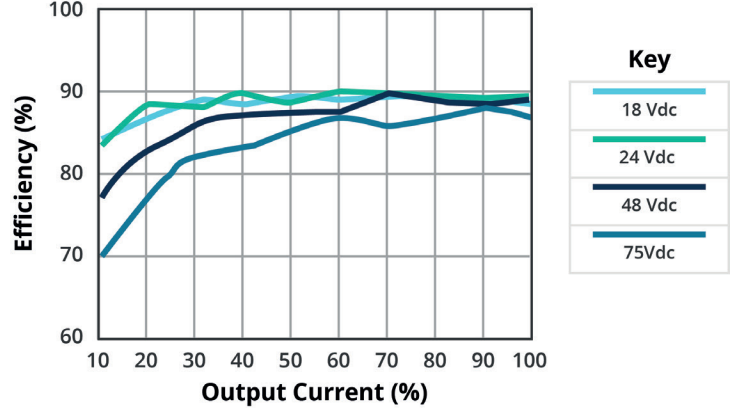

TEST CONFIGURATIONS

Input Ripple Current & Output Noise

Figure 1 Measuring Input Ripple Current

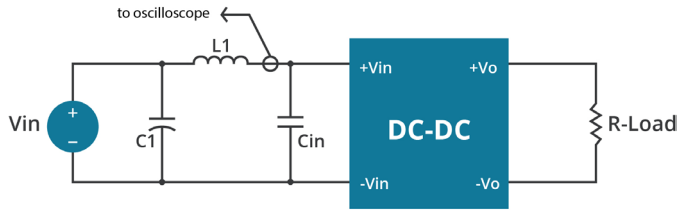

Figure 2 Measuring Output Ripple And Noise

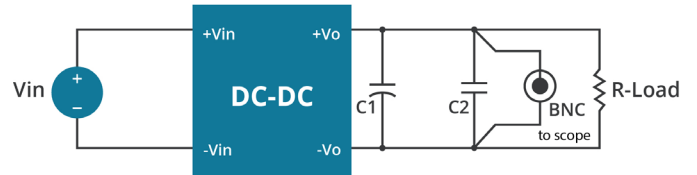

Table 1

L1	12 μ H
C1	220 μ F ESR < 0.1 Ω at 100 kHz
Cin	33 μ F ESR < 0.7 Ω at 100 kHz

Table 2

C1	10 μ F tantalum capacitor
C2	1 μ F ceramic capacitor

EMC RECOMMENDED CIRCUIT

Test Condition

Input Voltage: Nominal

Output Load: Full Load

Figure 3 Conducted Emissions Test Circuit

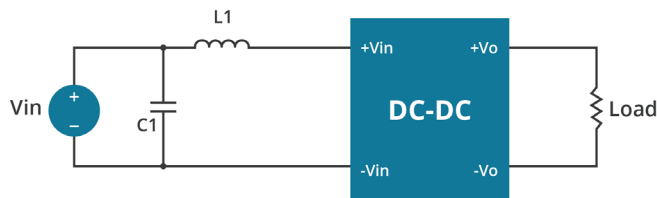

Table 3

EN55022 Class A Recommended External Circuit Components		
Input Voltage (Vdc)	C1	L1
24	100 μ F / 50 V	0.47 μ H
48	4.7 μ F / 100 V	2.2 μ H

APPLICATION NOTES

Output Voltage Trimming

The output voltage can be adjusted (single outputs only) by using the trim pin and the use of either an external trim pot or the use of a single fixed resistor (see Figures below). If the trim function is not needed, leave the trim pin open.

Figure 4 Trim Adjustments Using A Trimpot

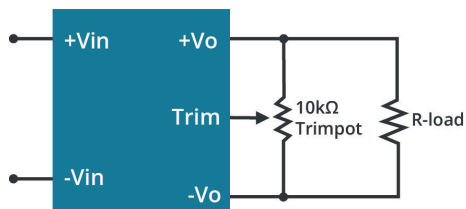

Figure 5 Trim Adjustments To Increase Output Voltage Using A Fixed Resistor

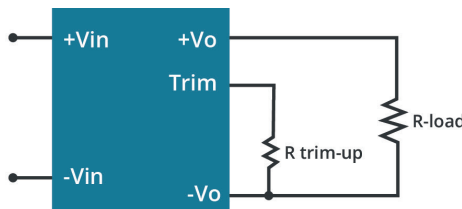
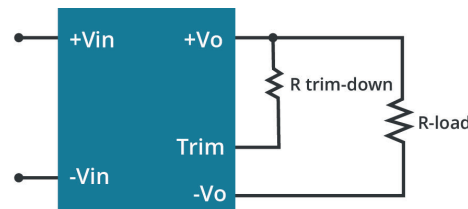

Figure 6 Trim Adjustments To Decrease Output Voltage Using A Fixed Resistor



$$R_{TRIM} = \left[\frac{V_{REF} \times R_{TOP} \times (R_{BOTTOM} + R_O)}{R_{BOTTOM} \times (V_{OUT} - V_{OUT, NOM})} \right] - R_T \text{ (K } \Omega \text{)}$$

Formula for Trim up

$$R_{TRIM} = R_{TOP} \times \left[\frac{V_{REF} \times R_{TOP}}{R_{BOTTOM} \times (V_{OUT, NOM} - V_{OUT})} - 1 \right] - R_T \text{ (K } \Omega \text{)}$$

Formula for Trim down

Table 4

V_{NOM}	R_{TOP}	R_{BOTTOM}	R_O	R_T	V_{REF}
(Vdc)	(kΩ)	(kΩ)	(kΩ)	(kΩ)	(V)
3.3	2.74	1.8	0.27	9.1	1.24
5	2.32	2.32	0	8.2	2.5
12	6.8	2.4	2.32	22	2.5
15	8.06	2.4	3.9	22	2.5

Note: Value for R_{TOP} , R_{BOTTOM} , R_O , R_T and V_{REF} refer to Table 4 (fixed internal values).

R_{TRIM} : Trim resistance

a: User-defined parameter, no actual meanings

V_{NOM} : Nominal output voltage

V_{OUT} : Target output voltage

REVISION HISTORY

rev.	description	date
1.0	initial release	07/12/2016
1.01	added 5 Vdc output efficiency curves	09/04/2018
1.02	safeties updated	05/25/2021
1.03	derating curve and circuit figures updated	03/14/2022
1.04	output voltage trimming updated	06/15/2023

The revision history provided is for informational purposes only and is believed to be accurate.



CUI INC
a bel group

Headquarters
20050 SW 112th Ave.
Tualatin, OR 97062
800.275.4899

Fax 503.612.2383
cui.com
techsupport@cui.com

CUI offers a two (2) year limited warranty. Complete warranty information is listed on our website.

CUI reserves the right to make changes to the product at any time without notice. Information provided by CUI is believed to be accurate and reliable. However, no responsibility is assumed by CUI for its use, nor for any infringements of patents or other rights of third parties which may result from its use.

CUI products are not authorized or warranted for use as critical components in equipment that requires an extremely high level of reliability. A critical component is any component of a life support device or system whose failure to perform can be reasonably expected to cause the failure of the life support device or system, or to affect its safety or effectiveness.

Looking for pricing, stock, or lifecycle information?

Click below to explore more details on WIN SOURCE:

 [View PDQ30-Q24-S3-D on WIN SOURCE](#)

 [CUI Inc. Information](#)

Optimize Your Supply Chain with WIN SOURCE Solutions

-  Global Sourcing Solution
-  Obsolete Management
-  Cost Control Management
-  Shortage Management
-  Alternative Solution
-  Excess Inventory Management