



THE DATASHEET OF H2.4-R-SR2-IN



2.4mm Series

2.4mm Coaxial Connectors MIL Standard Compliant



Millimeter Wave



COAX 2.4mm



MIL Standard



Jan. 1. 2024 Copyright 2024 HIROSE ELECTRIC CO., LTD. All Rights Reserved.



Features

1. 2.4mm coaxial connector conforming to MIL-STD-348B Standard

2. Supports up to 50GHz frequency

3. Board Receptacle is Screw-mounted

- Provides excellent high frequency performance and consistent mounting quality
- Reusable
- Reduces mounting complexity (No Soldering is required)
- Compatible with various PCB thicknesses

4. 0.085 inch flexible cable applicable

5. Terminator is also available.

6. RoHS2 compliant

Applications

Data transmission measurement, radio communication equipment, measuring instruments, RF module, radio frequency power amplifier, high speed router, high speed switch, broadcasting equipment, etc.

Product Specifications

Nominal Characteristic Impedance	50 Ω	Operating Temperature	-55 to +105°C (95% RH Max.)
Rated Frequency	0 to 50GHz	Storage Temperature Range	-55 to +50°C (95% RH Max.)

Items	Specifications	Conditions
Contact Resistance	Center : 4m Ω Max. External : 2m Ω Max.	Measured at 100mA Max.
Insulation Resistance	1000M Ω Min.	Measured at 100V DC
Withstanding Voltage	No breakdown	200V AC for 1 min.
V.S.W.R.*	● H2.4-P-SF085 V.S.W.R. 1.35 Max. (0 to 40GHz) V.S.W.R. 1.45 Max. (40 to 50GHz)	
	● H2.4-LR-SR2 V.S.W.R. 1.3 Max. (0 to 40GHz) V.S.W.R. 1.4 Max. (40 GHz to 50GHz)	
	● H2.4-R-SR2-SA V.S.W.R. 1.5 Max. (0 to 50GHz)	
Mating Cycles	Contact resistance Center : 6m Ω Max. External : 4m Ω Max. No broken, cracked, or loose parts	500 cycles
Vibration Resistance	No electrical discontinuity greater than 1 μ s. No broken, cracked, or loose parts	Frequency : 10 to 500Hz, half amplitude : 0.75mm, Acceleration : 196m/s ² , 10 cycles in each of the 3 axis
Shock Resistance	No electrical discontinuity greater than 1 μ s. No broken, cracked, or loose parts	Acceleration : 980m/s ² , duration : 6ms, Wave form : half-sine wave, 3 times in each of the 3 axis
Moisture Resistance of Temperature/Humidity Cycle	Insulation resistance : 100M Ω Min. (in a high humidity environment) Insulation resistance : 1000M Ω Min. (in a dry environment) No broken, cracked, or loose parts	Left for 10 cycles (240 hours) in an environment with the temperature ranging from -10 to 65°C and the humidity ranging from 90 to 98%.
Temperature Cycle	No broken, cracked, or loose parts	5 cycles of the following test series condition : Temperature : -55°C → - → +105°C → - Time : 30 min. → 3 min. → 30 min. → 3 min.
Salt Spray	No considerable corrosion	Continuous 48 hour cycle in 5% salt water solution

(Note) Information contained in this catalog represents general requirements for this Series. Contact us for the drawings and specifications for a specific part number shown.

*V.S.W.R. (Voltage Standing Wave Ratio) Measurement System

The above V.S.W.R. specification values were measured using the measurement system shown below.

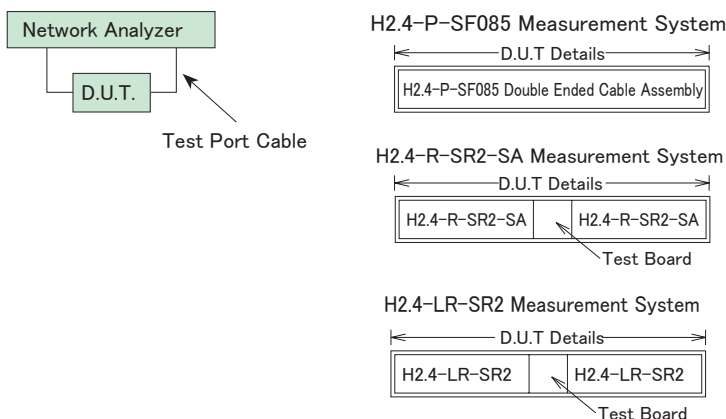

Materials / Finish

Part	Materials	Finish
Shell	Stainless Steel / Brass	Passivated / Nickel Plated / Gold Plated
Insulator	PTFE Resin / PEI Resin	-
Contact	Beryllium Copper	Gold Plated

Product Number Structure

Refer to the chart below when determining the product specifications from the product number.
Please select from the product numbers listed in this catalog when placing orders.

Receptacle

H2.4 - LR - SR2 (##)

① ② ③ ④

① Series Name	H2.4	③ Board Mounting Method	PCB Screw Mounting
② Connector Type	LR : End Launch Receptacle R : Receptacle	④ Attached Screw	(00) : - (11) : 0-80UNF 1/4 inch (12) : 0-80UNF 3/16 inch (15) : 0-80UNF 1/4 + 3/16 inch

Cable Assembly

H2.4 - 2P - SF085MC1 - A - 6IN

① ② ③ ④

① Series Name	H2.4	③ Cable Type	0.085 inch, Flexible Cable
② Assembly Type	Double-ended Straight Plug Cable Assembly	④ Total Length (inch)	6, 12, 24, 36, 48, 60 inch

Note : Plugs can be ordered only as terminated cable assemblies.

Functional Diagram

Plug Side

- Straight Plug
H2.4-P-SF085



Receptacle Side

- PCB Vertical Launch Receptacle
H2.4-R-SR2-SA



Non-Reflective Terminator

- Plug
H2.4-TMP



- PCB End Launch Receptacle
H2.4-LR-SR2



Plug

Plugs can be ordered only as terminated cable assemblies.

● H2.4-P-SF085

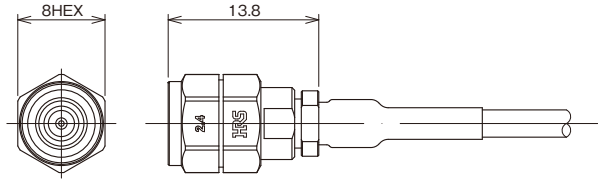

Cable Assembly (H2.4 Straight Plug - H2.4 Straight Plug)

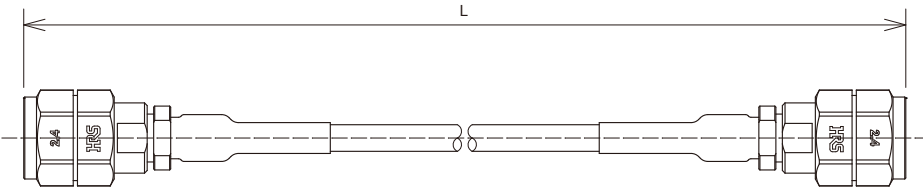
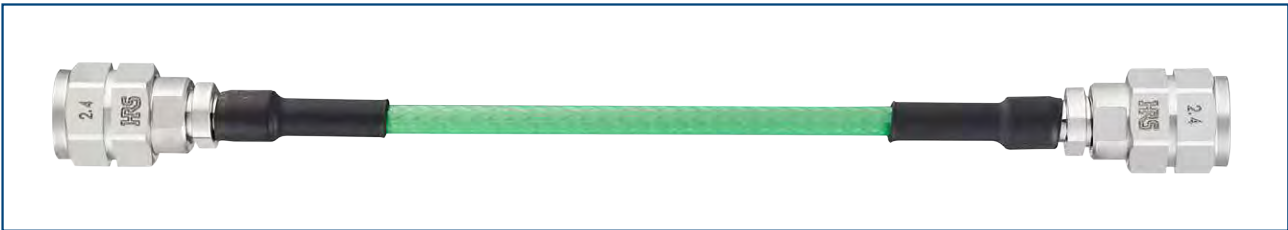

Part No.	HRS No.	Cable Assembly Length L		Purchase Unit
		Unit : inch	Unit : mm	
H2.4-2P-SF085MC1-A-6IN	CL0321-5132-0-01	6 ± 0.16	152.4 ± 4	20pcs per bag
H2.4-2P-SF085MC1-A-12IN	CL0321-5132-0-02	12 ± 0.32	304.8 ± 8	
H2.4-2P-SF085MC1-A-24IN	CL0321-5132-0-03	24 ± 0.48	609.6 ± 12	
H2.4-2P-SF085MC1-A-36IN	CL0321-5132-0-04	36 ± 0.48	914.4 ± 12	
H2.4-2P-SF085MC1-A-48IN	CL0321-5132-0-05	48 ± 0.71	1219.2 ± 18	
H2.4-2P-SF085MC1-A-60IN	CL0321-5132-0-06	60 ± 0.87	1524.0 ± 22	

PCB End Launch Receptacle (For High Speed Transmission Evaluation Board)

This product is a solderless mounted connector for prototype evaluation of high speed transmission boards. It is not recommended for use in actual commercial equipment.

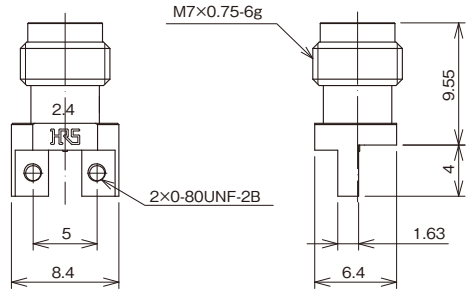

Part No.	HRS No.	Attached Screw	Purchase Unit
H2.4-LR-SR2	CL0338-0603-0-00	-	20pcs per bag
H2.4-LR-SR2(11)	CL0338-0603-0-11	0-80UNF 1/4 inch	
H2.4-LR-SR2(12)	CL0338-0603-0-12	0-80UNF 3/16 inch	

◆ Frequency Characteristics (TYPICAL)

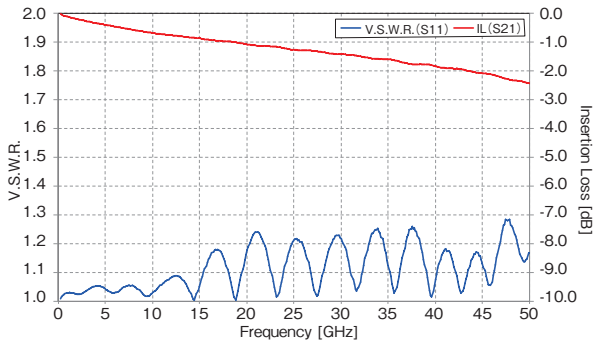

*Coplaner line length between both connector ends : 20mm

Jan.1.2024 Copyright 2024 HIROSE ELECTRIC CO., LTD. All Rights Reserved.

PCB Vertical Mount Receptacle (For High Speed Transmission Evaluation Board)

This product is a solderless mounted connector for prototype evaluation of high speed transmission boards. It is not recommended for use in actual commercial equipment.

● Inner Layer, Back Surface, Top Surface Trace Type

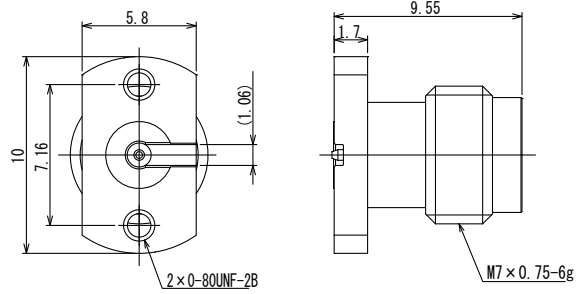

Part No.	HRS No.	Attached Screw	Purchase Unit
H2.4-R-SR2-SA	CL0338-0029-0-00	-	20pcs per bag
H2.4-R-SR2-SA(15)	CL0338-0029-0-15	0-80UNF 1/4 + 3/16 inch	

◆ Frequency Characteristics (TYPICAL)

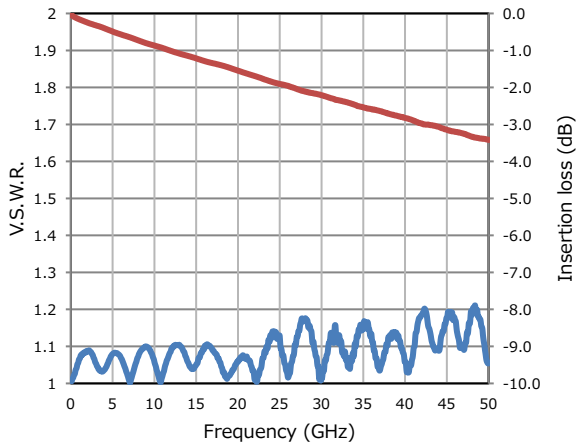

*Coplaner line length between both connector ends : 25mm

Precautions

1. The diameter of the center contact pin is only 0.511mm.
Please handle with care. When mating the component with the corresponding connector, rotate the hex part only.
2. If any dust is found on the shell interface when mating the components, please wipe with alcohol.

While Taking into Consideration

Specifications mentioned in this catalog are reference values.

When considering to order or use this product, please review the Drawing and Product Specifications sheets.

Use an appropriate cable when using the connector in combination with cables.

If considering usage of a non-specified cable, please contact your sales representative.

If assembly process is done by jigs & tools which are not identified by Hirose, the warranty of the product may be affected.

If considering usage for below mentioned applications, please contact your sales representative.

In cases where the application will demand a high level of reliability, such as automotive, medical instruments, public infrastructure, aerospace/defense etc. Hirose must review before assurance of reliability can be given.

2.4mm-TM Series

2.4mm Coaxial Connectors

MIL Standard Compliant/Non-Reflective Terminator

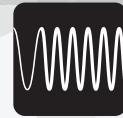

Millimeter Wave



COAX 2.4mm

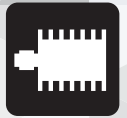

Terminator



Features

1. Non-reflective Terminator Supporting 0 to 50GHz
2. Small Size, Light Weight
3. Low V.S.W.R. & High Reliability
4. MIL Compliant (MIL-STD-348B) 2.4mm Coaxial Terminator

Applications

Optical transmission devices, data transmission measurement, radio communication equipment, measuring instruments, other high frequency devices, etc.

Product Specifications

Nominal Characteristic Impedance	50 Ω	Operating Temperature	-40 to +85°C
Rated Frequency	0 to 50GHz	Operating Relative Humidity	95% RH Max.
Power	0.5W CW (+65°C)		

Materials / Finish

Part	Materials	Finish
Shell	Stainless Steel / Brass	Passivated / Gold Plated / Nickel Plated
Insulator	PTFE Resin	–
Male Contact	Brass	Gold Plated
Coupling	Stainless Steel	Passivated
Resistive Element	Metal Film	–

Product Number Structure

H2.4 - TM P

- ① ② ③

① Series Name	H2.4	③ Connector Type	P : Plug Type
② TM	Non-reflective Terminator		

Terminator

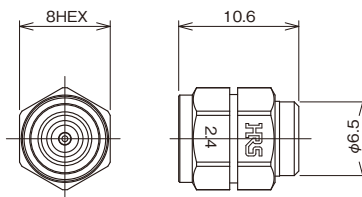

Part No.	HRS No.	Purchase Unit
H2.4-TMP	CL0353-0174-0-00	1pc per bag

V.S.W.R. (Max.)

0 to 50GHz
1.2

◆Frequency Characteristics (TYPICAL)

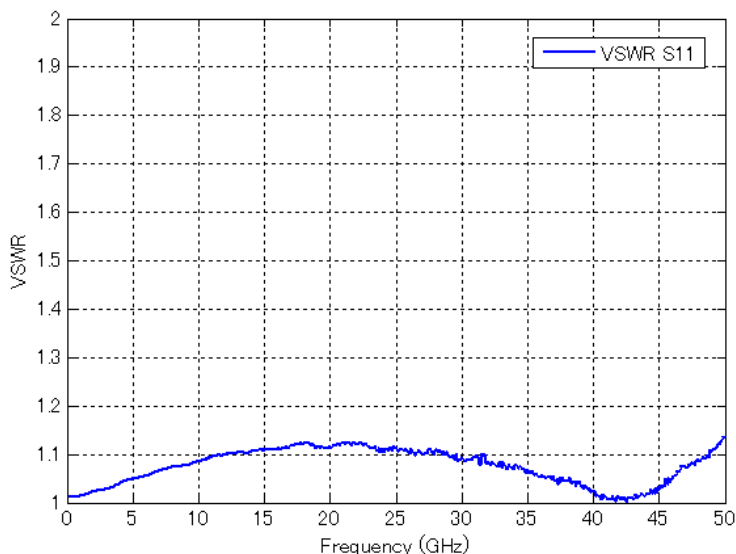

Jan. 1. 2024 Copyright 2024 HIROSE ELECTRIC CO., LTD. All Rights Reserved.

Precautions

1. The diameter of the center contact pin is only 0.511mm.
Please handle with care. When mating the component with the corresponding connector, rotate the hex part only.
2. If any dust is found on the shell interface when mating the components, please wipe with alcohol.

While Taking into Consideration

Specifications mentioned in this catalog are reference values.

When considering to order or use this product, please review the Drawing and Product Specifications sheets.

Use an appropriate cable when using the connector in combination with cables.

If considering usage of a non-specified cable, please contact your sales representative.

If assembly process is done by jigs & tools which are not identified by Hirose, the warranty of the product may be affected.

If considering usage for below mentioned applications, please contact your sales representative.

In cases where the application will demand a high level of reliability, such as automotive, medical instruments, public infrastructure, aerospace/defense etc. Hirose must review before assurance of reliability can be given.

Looking for pricing, stock, or lifecycle information?

Click below to explore more details on WIN SOURCE:

-  [View H2.4-R-SR2-IN on WIN SOURCE](#)
-  [Hirose Electric Co Ltd Information](#)

Optimize Your Supply Chain with WIN SOURCE Solutions

-  Global Sourcing Solution
-  Obsolete Management
-  Cost Control Management
-  Shortage Management
-  Alternative Solution
-  Excess Inventory Management