



**THE DATASHEET OF  
DSS4540X-13**



## Features

- Complementary PNP Type Available (DSS5540X)
- Ultra Low Collector-Emitter Saturation Voltage
- Ideally Suited for Automated Assembly Processes
- Ideal for Medium Power Switching or Amplification Applications
- **Lead Free By Design/RoHS Compliant (Note 1)**
- **"Green" Device (Note 2)**



Top View

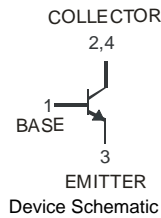

Device Schematic

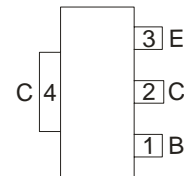

Pin Out Configuration

## Mechanical Data

- Case: SOT89-3L
- Case Material: Molded Plastic, "Green" Molding Compound. UL Flammability Classification Rating 94V-0
- Moisture Sensitivity: Level 1 per J-STD-020D
- Terminals: Finish — Matte Tin annealed over Copper leadframe (Lead Free Plating). Solderable per MIL-STD-202, Method 208
- Marking Information: See Page 4
- Ordering Information: See Page 4
- Weight: 0.072 grams (approximate)

## Maximum Ratings @ $T_A = 25^\circ\text{C}$ unless otherwise specified

| Characteristic                        | Symbol    | Value | Unit |
|---------------------------------------|-----------|-------|------|
| Collector-Base Voltage                | $V_{CB0}$ | 40    | V    |
| Collector-Emitter Voltage             | $V_{CE0}$ | 40    | V    |
| Emitter-Base Voltage                  | $V_{EB0}$ | 6     | V    |
| Continuous Collector Current          | $I_C$     | 4     | A    |
| Repetitive Collector Current (Note 3) | $I_{CRM}$ | 5     | A    |
| Peak Pulse Collector Current          | $I_{CM}$  | 10    | A    |
| Continuous Base Current               | $I_B$     | 1     | A    |
| Peak Pulse Base Current               | $I_{BM}$  | 2     | A    |

## Thermal Characteristics

| Characteristic  | Symbol          | Value       | Unit               |
|---|-----------------|-------------|--------------------|
| Power Dissipation (Note 4) @ $T_A = 25^\circ\text{C}$                           | $P_D$           | 0.9         | W                  |
| Thermal Resistance, Junction to Ambient Air (Note 4) @ $T_A = 25^\circ\text{C}$ | $R_{\theta JA}$ | 139         | $^\circ\text{C/W}$ |
| Power Dissipation (Note 5) @ $T_A = 25^\circ\text{C}$                           | $P_D$           | 2           | W                  |
| Thermal Resistance, Junction to Ambient Air (Note 5) @ $T_A = 25^\circ\text{C}$ | $R_{\theta JA}$ | 62.5        | $^\circ\text{C/W}$ |
| Operating and Storage Temperature Range   | $T_J, T_{STG}$  | -55 to +150 | $^\circ\text{C}$   |

- Notes:
1. No purposefully added lead.
  2. Diodes Inc.'s "Green" policy can be found on our website at [http://www.diodes.com/products/lead\\_free/index.php](http://www.diodes.com/products/lead_free/index.php).
  3. Operated under pulsed conditions: pulse width  $\leq 10\text{ms}$ ; duty cycle  $\leq 0.2$ .
  4. Device mounted on FR-4 PCB with minimum recommended pad layout.
  5. Device mounted on FR-4 PCB with 1 inch<sup>2</sup> copper pad layout.

**Electrical Characteristics** @ $T_A = 25^\circ\text{C}$  unless otherwise specified

| Characteristic                               | Symbol        | Min | Typ | Max | Unit          | Test Conditions   |
|--|---------------|-----|-----|-----|---------------|---|
| <b>OFF CHARACTERISTICS</b>                   |               |     |     |     |               |   |
| Collector-Base Breakdown Voltage             | $V_{(BR)CBO}$ | 40  | —   | —   | V             | $I_C = 100\mu\text{A}$  |
| Collector-Emitter Breakdown Voltage (Note 6) | $V_{(BR)CEO}$ | 40  | —   | —   | V             | $I_C = 10\text{mA}$   |
| Emitter-Base Breakdown Voltage               | $V_{(BR)EBO}$ | 6   | —   | —   | V             | $I_E = 100\mu\text{A}$  |
| Collector-Base Cutoff Current                | $I_{CBO}$     | —   | —   | 100 | nA            | $V_{CB} = 30\text{V}, I_E = 0$  |
|  |               | —   | —   | 50  | $\mu\text{A}$ | $V_{CB} = 30\text{V}, I_E = 0, T_A = 150^\circ\text{C}$               |
| Collector-Emitter Cut-Off Current            | $I_{CES}$     | —   | —   | 100 | nA            | $V_{CE} = 30\text{V}, V_{BE} = 0\text{V}$                             |
| Emitter-Base Cutoff Current                  | $I_{EBO}$     | —   | —   | 100 | nA            | $V_{EB} = 5\text{V}, I_C = 0$   |
| <b>ON CHARACTERISTICS (Note 6)</b>           |               |     |     |     |               |   |
| DC Current Gain                              | $h_{FE}$      | 300 | —   | —   | —             | $V_{CE} = 2\text{V}, I_C = 0.5\text{A}$                               |
|  |               | 300 | —   | —   |               | $V_{CE} = 2\text{V}, I_C = 1\text{A}$                                 |
|  |               | 250 | —   | —   |               | $V_{CE} = 2\text{V}, I_C = 2\text{A}$                                 |
|  |               | 100 | —   | —   |               | $V_{CE} = 2\text{V}, I_C = 5\text{A}$                                 |
| Collector-Emitter Saturation Voltage         | $V_{CE(SAT)}$ | —   | —   | 90  | mV            | $I_C = 0.5\text{A}, I_B = 5\text{mA}$                                 |
|  |               | —   | —   | 120 |               | $I_C = 1\text{A}, I_B = 10\text{mA}$                                  |
|  |               | —   | 80  | 150 |               | $I_C = 2\text{A}, I_B = 200\text{mA}$                                 |
|  |               | —   | 160 | 290 |               | $I_C = 4\text{A}, I_B = 200\text{mA}$                                 |
|  |               | —   | 185 | 355 |               | $I_C = 5\text{A}, I_B = 500\text{mA}$                                 |
| Equivalent On-Resistance                     | $R_{CE(SAT)}$ | —   | 37  | 71  | m $\Omega$    | $I_C = 5\text{A}, I_B = 500\text{mA}$                                 |
| Base-Emitter Saturation Voltage              | $V_{BE(SAT)}$ | —   | —   | 1.1 | V             | $I_C = 4\text{A}, I_B = 200\text{mA}$                                 |
|  |               | —   | —   | 1.2 |               | $I_C = 5\text{A}, I_B = 500\text{mA}$                                 |
| Base-Emitter Turn-on Voltage                 | $V_{BE(ON)}$  | —   | —   | 1.1 | V             | $V_{CE} = 2\text{V}, I_C = 2\text{A}$                                 |
| <b>SMALL SIGNAL CHARACTERISTICS</b>          |               |     |     |     |               |   |
| Transition Frequency                         | $f_T$         | 70  | —   | —   | MHZ           | $V_{CE} = 10\text{V}, I_C = 0.1\text{A}, f = 100\text{MHz}$           |
| Collector Capacitance                        | $C_C$         | —   | —   | 75  | pF            | $V_{CB} = 10\text{V}, I_E = 0\text{A}, f = 1\text{MHz}$               |
| <b>SWITCHING CHARACTERISTICS</b>             |               |     |     |     |               |   |
| Turn-On Time                                 | $t_{on}$      | —   | 135 | —   | ns            | $V_{CC} = 10\text{V}, I_C = 2\text{A}, I_{B1} = 40\text{mA}$          |
| Delay Time                                   | $t_d$         | —   | 60  | —   | ns            |   |
| Rise Time                                    | $t_r$         | —   | 75  | —   | ns            |   |
| Turn-Off Time                                | $t_{off}$     | —   | 670 | —   | ns            | $V_{CC} = 10\text{V}, I_C = 2\text{A}, I_{B1} = I_{B2} = 40\text{mA}$ |
| Storage Time                                 | $t_s$         | —   | 570 | —   | ns            |   |
| Fall Time                                    | $t_f$         | —   | 100 | —   | ns            |   |

Notes: 6. Measured under pulsed conditions. Pulse width = 300 $\mu\text{s}$ . Duty cycle  $\leq 2\%$ .

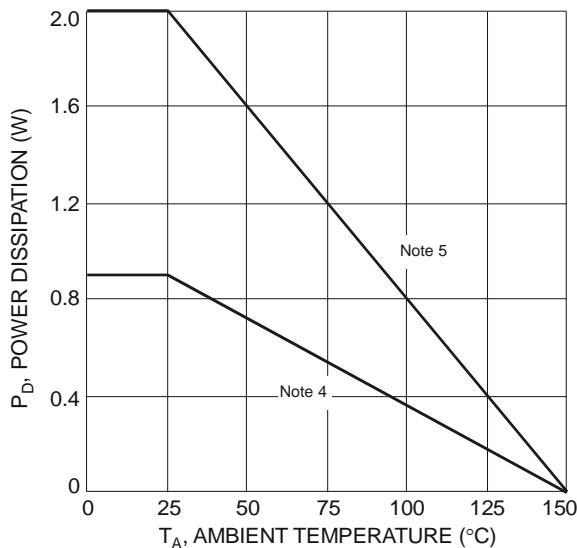

Fig. 1 Power Dissipation vs. Ambient Temperature

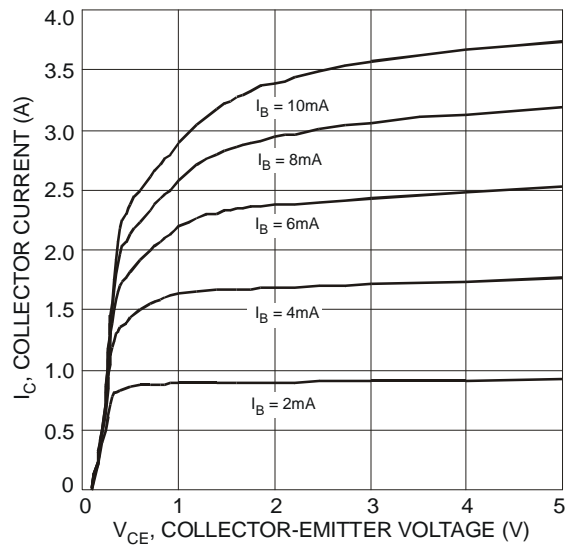

Fig. 2 Typical Collector Current vs. Collector-Emitter Voltage

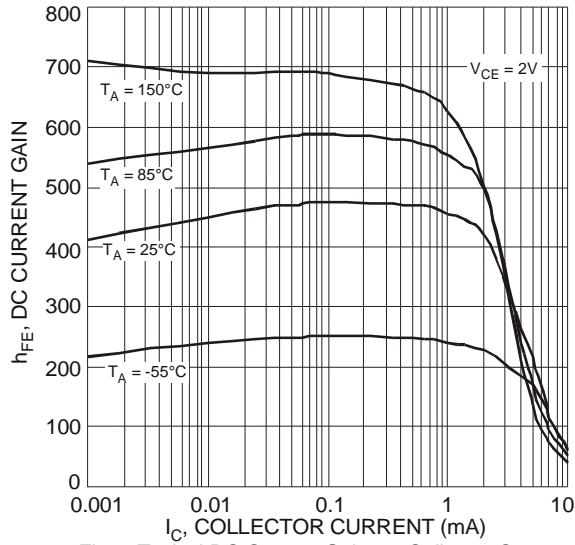

Fig. 3 Typical DC Current Gain vs. Collector Current

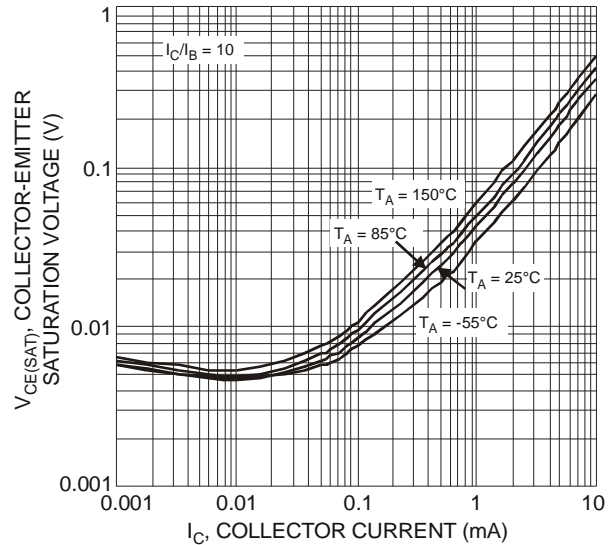

Fig. 4 Typical Collector-Emitter Saturation Voltage vs. Collector Current

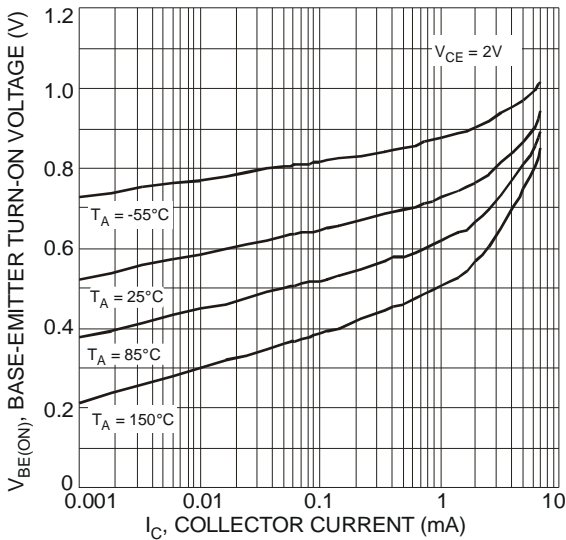

Fig. 5 Typical Base-Emitter Turn-On Voltage vs. Collector Current

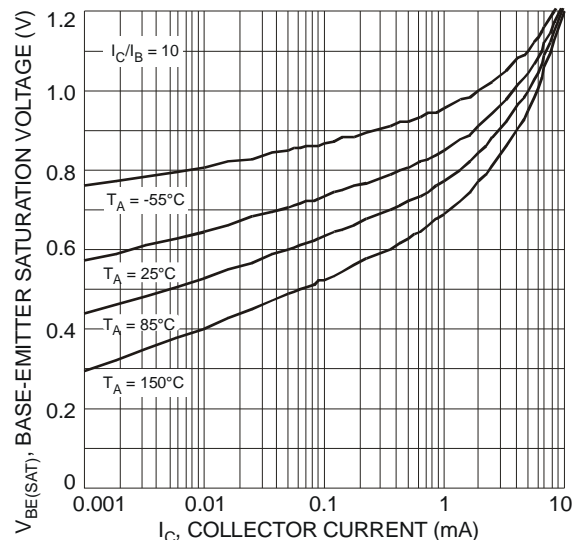

Fig. 6 Typical Base-Emitter Saturation Voltage vs. Collector Current

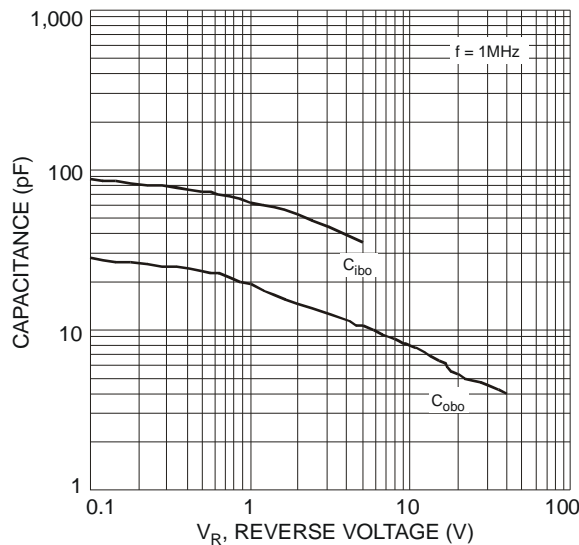

Fig. 7 Typical Capacitance Characteristics

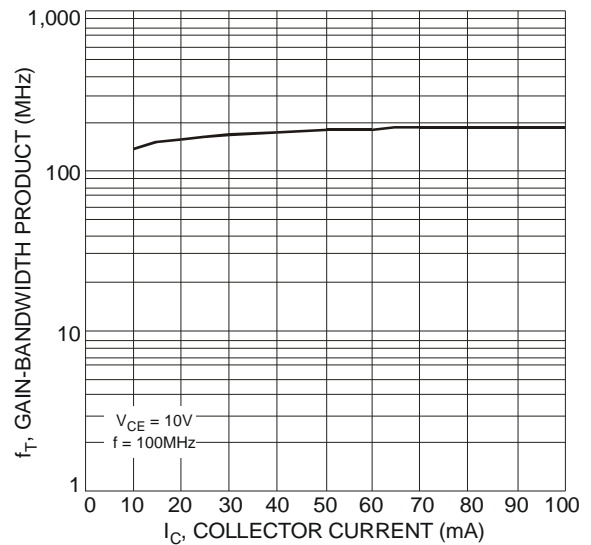
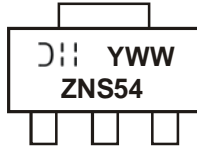

Fig. 8 Typical Gain-Bandwidth Product vs. Collector Current

**Ordering Information** (Note 7)

| Part Number | Case     | Packaging        |
|-------------|----------|------------------|
| DSS4540X-13 | SOT89-3L | 2500/Tape & Reel |

Notes: 7. For packaging details, go to our website at <http://www.diodes.com/datasheets/ap02007.pdf>.

**Marking Information**

ZNS54 = Product Type Marking Code  
 ⌋⌋⌋ = Manufacturer's Code Marking  
 YWW = Date Code Marking  
 Y = Last digit of year (ex: 8 = 2008)  
 WW = Week code 01 - 52

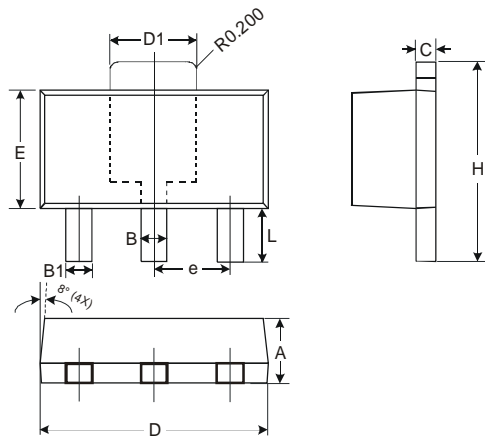
**Package Outline Dimensions**

| SOT89-3L             |      |      |      |
|----------------------|------|------|------|
| Dim                  | Min  | Max  | Typ  |
| A                    | 1.40 | 1.60 | 1.50 |
| B                    | 0.45 | 0.55 | 0.50 |
| B1                   | 0.37 | 0.47 | 0.42 |
| C                    | 0.35 | 0.43 | 0.38 |
| D                    | 4.40 | 4.60 | 4.50 |
| D1                   | 1.50 | 1.70 | 1.60 |
| E                    | 2.40 | 2.60 | 2.50 |
| e                    | —    | —    | 1.50 |
| H                    | 3.95 | 4.25 | 4.10 |
| L                    | 0.90 | 1.20 | 1.05 |
| All Dimensions in mm |      |      |      |

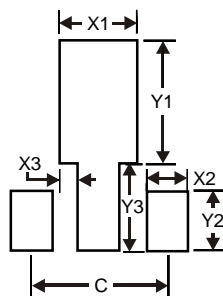
**Suggested Pad Layout**

| Dimensions | Value (in mm) |
|------------|---------------|
| X1         | 1.7           |
| X2         | 0.9           |
| X3         | 0.4           |
| Y1         | 2.7           |
| Y2         | 1.3           |
| Y3         | 1.9           |
| C          | 3.0           |

**IMPORTANT NOTICE**

Diodes Incorporated and its subsidiaries reserve the right to make modifications, enhancements, improvements, corrections or other changes without further notice to any product herein. Diodes Incorporated does not assume any liability arising out of the application or use of any product described herein; neither does it convey any license under its patent rights, nor the rights of others. The user of products in such applications shall assume all risks of such use and will agree to hold Diodes Incorporated and all the companies whose products are represented on our website, harmless against all damages.

**LIFE SUPPORT**

Diodes Incorporated products are not authorized for use as critical components in life support devices or systems without the expressed written approval of the President of Diodes Incorporated.

NEW PRODUCT

## Looking for pricing, stock, or lifecycle information?

Click below to explore more details on WIN SOURCE:

 [View DSS4540X-13 on WIN SOURCE](#)

 [Diodes Incorporated](#) Information

## Optimize Your Supply Chain with WIN SOURCE Solutions

-  Global Sourcing Solution
-  Obsolete Management
-  Cost Control Management
-  Shortage Management
-  Alternative Solution
-  Excess Inventory Management