



THE DATASHEET OF DTC114TSA



100mA / 50V Digital transistors (with built-in resistors)

DTC114TM / DTC114TE / DTC114TUA / DTC114TKA / DTC114TSA

●Applications

Inverter, Interface, Driver

●Features

- 1) Built-in bias resistors enable the configuration of an inverter circuit without connecting external input resistors (see equivalent circuit).
- 2) The bias resistors consist of thin-film resistors with complete isolation to allow negative biasing of the input. They also have the advantage of almost completely eliminating parasitic effects.
- 3) Only the on/off conditions need to be set for operation, making the device design easy.

●Structure

NPN epitaxial planar silicon transistor (Resistor built-in type)

●External dimensions (Unit : mm)

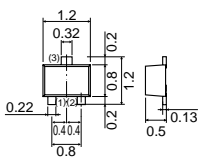
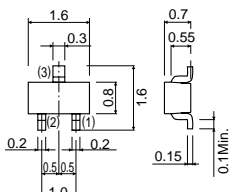
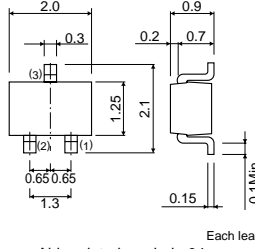
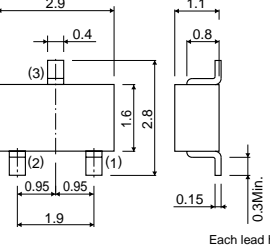
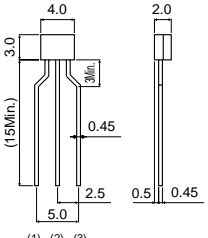
<p>DTC114TM</p>  <p>ROHM : VMT3 Abbreviated symbol : 04</p> <p>(1) Base (2) Emitter (3) Collector</p>	<p>DTC114TE</p>  <p>ROHM : EMT3 Abbreviated symbol : 04</p> <p>(1) Emitter (2) Base (3) Collector</p>
<p>DTC114TUA</p>  <p>ROHM : UMT3 EIAJ : SC-70 Abbreviated symbol : 04</p> <p>(1) Emitter (2) Base (3) Collector</p> <p>Each lead has same dimensions</p>	<p>DTC114TKA</p>  <p>ROHM : SMT3 EIAJ : SC-59 Abbreviated symbol : 04</p> <p>(1) Emitter (2) Base (3) Collector</p> <p>Each lead has same dimensions</p>
<p>DTC114TSA</p>  <p>ROHM : SPT EIAJ : SC-72 Abbreviated symbol : C114TS</p> <p>(1) Emitter (2) Collector (3) Base</p>	

DTC114TM / DTC114TE / DTC114TUA DTC114TKA / DTC114TSA

Transistors

●Packaging specifications

Part No.	Package	VMT3	EMT3	UMT3	SMT3	SPT
	Package type	Taping	Taping	Taping	Taping	Taping
	Code	T2L	TL	T106	T146	TP
	Basic ordering unit (pieces)	8000	3000	3000	3000	5000
DTC114TM	○	—	—	—	—	—
DTC114TE	—	○	—	—	—	—
DTC114TUA	—	—	○	—	—	—
DTC114TKA	—	—	—	○	—	—
DTC114TSA	—	—	—	—	—	○

●Equivalent circuit

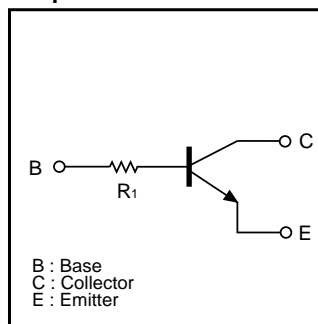

$R_1=10k\Omega$

●Absolute maximum ratings ($T_a=25^\circ\text{C}$)

Parameter	Symbol	Limits					Unit
		DTA114TM	DTA114TE	DTA114TUA	DTA114TKA	DTA114TSA	
Collector-base voltage	V_{CB0}	50					V
Collector-emitter voltage	V_{CE0}	50					V
Emitter-base voltage	V_{EB0}	5					V
Collector current	I_C	100					mA
Collector power dissipation	P_C	150		200		300	mW
Junction temperature	T_j	150					$^\circ\text{C}$
Storage temperature	T_{stg}	-55 to +150					$^\circ\text{C}$

●Electrical characteristics ($T_a=25^\circ\text{C}$)

Parameter	Symbol	Min.	Typ.	Max.	Unit	Conditions
Collector-base breakdown voltage	BV_{CB0}	50	—	—	V	$I_C=50\mu\text{A}$
Collector-emitter breakdown voltage	BV_{CE0}	50	—	—	V	$I_C=1\text{mA}$
Emitter-base breakdown voltage	BV_{EB0}	5	—	—	V	$I_E=50\mu\text{A}$
Collector cutoff current	I_{CBO}	—	—	0.5	μA	$V_{CB}=50\text{V}$
Emitter cutoff current	I_{EBO}	—	—	0.5	μA	$V_{EB}=4\text{V}$
Collector-emitter saturation voltage	$V_{CE(sat)}$	—	—	0.3	V	$I_C/I_B=10\text{mA}/1\text{mA}$
DC current transfer ratio	h_{FE}	100	250	600	—	$V_{CE}=5\text{V}$, $I_C=1\text{mA}$
Input resistance	R_1	7	10	13	$k\Omega$	—
Transition frequency	f_T *	—	250	—	MHz	$V_{CE}=10\text{V}$, $I_E=-5\text{mA}$, $f=100\text{MHz}$

* Characteristics of built-in transistor

Transistors

●Electrical characteristic curves

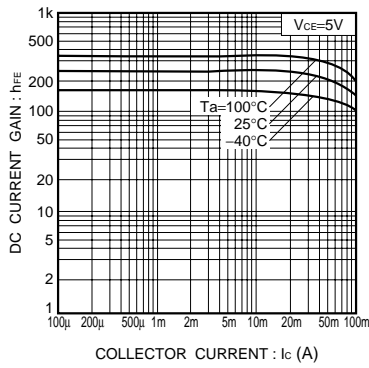

Fig.1 DC current gain vs. collector current

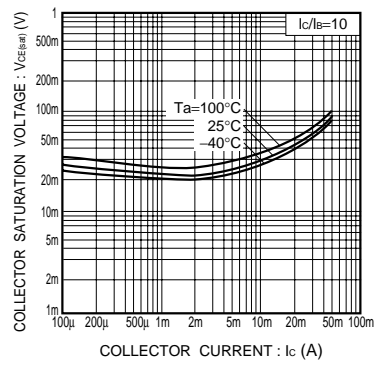

Fig.2 Collector-emitter saturation voltage vs. collector current

Notes

- No technical content pages of this document may be reproduced in any form or transmitted by any means without prior permission of ROHM CO.,LTD.
- The contents described herein are subject to change without notice. The specifications for the product described in this document are for reference only. Upon actual use, therefore, please request that specifications to be separately delivered.
- Application circuit diagrams and circuit constants contained herein are shown as examples of standard use and operation. Please pay careful attention to the peripheral conditions when designing circuits and deciding upon circuit constants in the set.
- Any data, including, but not limited to application circuit diagrams information, described herein are intended only as illustrations of such devices and not as the specifications for such devices. ROHM CO.,LTD. disclaims any warranty that any use of such devices shall be free from infringement of any third party's intellectual property rights or other proprietary rights, and further, assumes no liability of whatsoever nature in the event of any such infringement, or arising from or connected with or related to the use of such devices.
- Upon the sale of any such devices, other than for buyer's right to use such devices itself, resell or otherwise dispose of the same, no express or implied right or license to practice or commercially exploit any intellectual property rights or other proprietary rights owned or controlled by
- ROHM CO., LTD. is granted to any such buyer.
- Products listed in this document are no antiradiation design.

The products listed in this document are designed to be used with ordinary electronic equipment or devices (such as audio visual equipment, office-automation equipment, communications devices, electrical appliances and electronic toys).

Should you intend to use these products with equipment or devices which require an extremely high level of reliability and the malfunction of which would directly endanger human life (such as medical instruments, transportation equipment, aerospace machinery, nuclear-reactor controllers, fuel controllers and other safety devices), please be sure to consult with our sales representative in advance.



About Export Control Order in Japan

Products described herein are the objects of controlled goods in Annex 1 (Item 16) of Export Trade Control Order in Japan.

In case of export from Japan, please confirm if it applies to "objective" criteria or an "informed" (by MITI clause) on the basis of "catch all controls for Non-Proliferation of Weapons of Mass Destruction.

Looking for pricing, stock, or lifecycle information?

Click below to explore more details on WIN SOURCE:

-  [View DTC114TSA on WIN SOURCE](#)
-  [Rohm Semiconductor](#) Information

Optimize Your Supply Chain with WIN SOURCE Solutions

-  Global Sourcing Solution
-  Obsolete Management
-  Cost Control Management
-  Shortage Management
-  Alternative Solution
-  Excess Inventory Management