



**THE DATASHEET OF
DTC363TK**



Digital transistors (built-in resistor)

DTC363TK / DTC363TS

●Features

In addition to the features of regular digital transistors,

- 1) Low $V_{CE(sat)}$ makes these transistors optimal for muting circuits.

$$V_{CE(sat)} = 40\text{mV (Typ.)}$$

$$(I_c/I_b = 50\text{mA}/2.5\text{mA})$$

- 2) They can be used at high current ($I_c = 600\text{mA}$).

●Structure

NPN digital transistor
(Built-in resistor type)

●Equivalent circuit

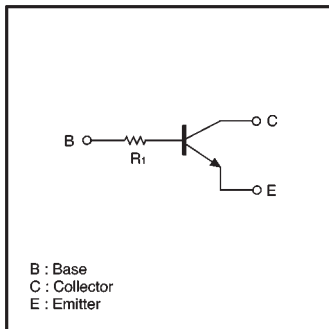

●External dimensions (Units: mm)

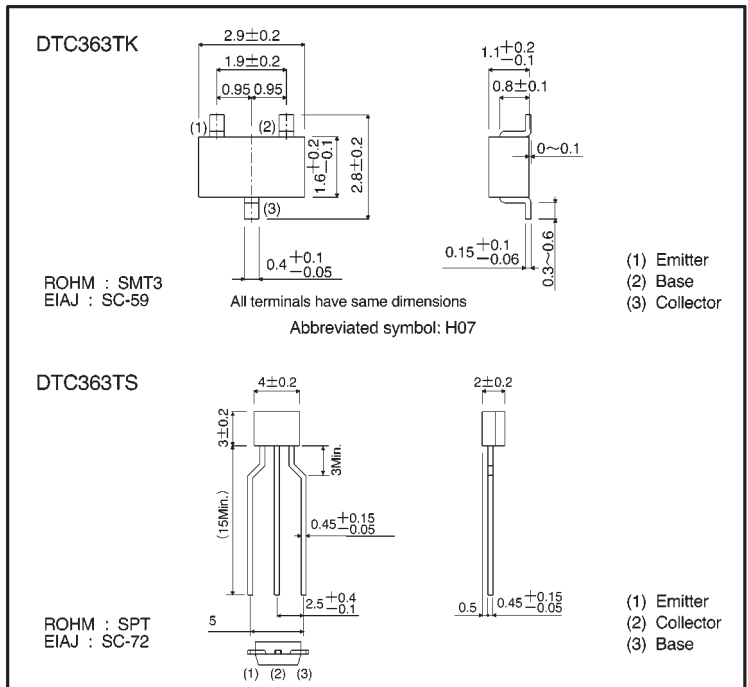

● Absolute maximum ratings (Ta = 25°C)

Parameter	Symbol	Limits(DTC363T□)		Unit
		K	S	
Collector-base voltage	V _{CBO}	30		V
Collector-emitter voltage	V _{CEO}	15		V
Emitter-base voltage	V _{EBO}	5		V
Collector current	I _c	600		mA
Collector power dissipation	P _c	200	300	mW
Junction temperature	T _j	150		°C
Storage temperature	T _{stg}	-55~+150		°C

● Electrical characteristics (Ta = 25°C)

Parameter	Symbol	Min.	Typ.	Max.	Unit	Conditions
Collector-base breakdown voltage	BV _{CBO}	30	—	—	V	I _c =50 μA
Collector-emitter breakdown voltage	BV _{CEO}	15	—	—	V	I _c =1mA
Emitter-base breakdown voltage	BV _{EBO}	5	—	—	V	I _E =50 μA
Collector cutoff current	I _{CBO}	—	—	0.5	μA	V _{CB} =20V
Emitter cutoff current	I _{EBO}	—	—	0.5	μA	V _{EB} =4V
Collector-emitter saturation voltage	V _{CE(sat)}	—	40	80	mV	I _c /I _B =50mA/2.5mA
DC current transfer ratio	h _{FE}	100	250	600	—	V _{CE} =5V, I _c =50mA
Input resistance	R _i	4.76	6.8	8.84	kΩ	—
Transition frequency	f _r	—	200	—	MHz	V _{CE} =10V, I _E =-50mA, f=100MHz *
Output "ON" resistance	R _{on}	—	1.25	—	Ω	V _I =7V, R _L =1kΩ, f=1kHz

* Transition frequency of the device

● Packaging specifications

Part No.	Package	SMT3	SPT
	Packaging type	Taping	Taping
	Code	T146	TP
	Basic ordering unit (pieces)	3000	5000
DTC363TK		○	—
DTC363TS		—	○

● R_{on} measurement circuit

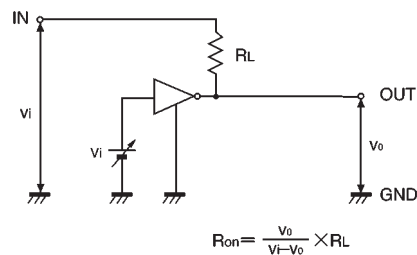

Fig.1 Input "on" resistance (R_{on}) measurement circuit

● Electrical characteristic curves

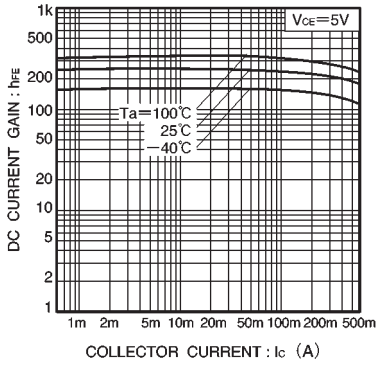

Fig.2 DC current gain vs. collector current

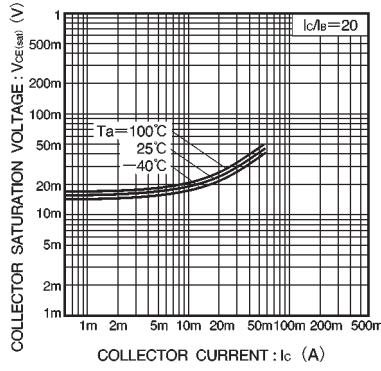

Fig.3 Collector-emitter saturation voltage vs. collector current

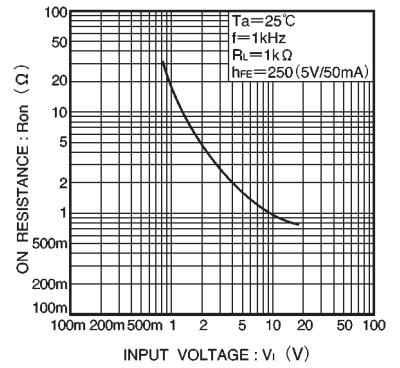





Fig.4 "ON" resistance vs. input voltage

Looking for pricing, stock, or lifecycle information?

Click below to explore more details on WIN SOURCE:

-  [View DTC363TK on WIN SOURCE](#)
-  [Rohm Semiconductor Information](#)

Optimize Your Supply Chain with WIN SOURCE Solutions

-  Global Sourcing Solution
-  Obsolete Management
-  Cost Control Management
-  Shortage Management
-  Alternative Solution
-  Excess Inventory Management