



**THE DATASHEET OF  
DTC363TK T146**



# Digital transistors (built-in resistor)

## DTC363TK / DTC363TS

### ●Features

In addition to the features of regular digital transistors,

- 1) Low  $V_{CE(sat)}$  makes these transistors optimal for muting circuits.

$$V_{CE(sat)} = 40\text{mV (Typ.)}$$

$$(I_c/I_b = 50\text{mA}/2.5\text{mA})$$

- 2) They can be used at high current ( $I_c = 600\text{mA}$ ).

### ●Structure

NPN digital transistor  
(Built-in resistor type)

### ●Equivalent circuit

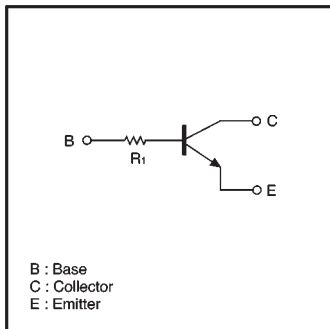

### ●External dimensions (Units: mm)

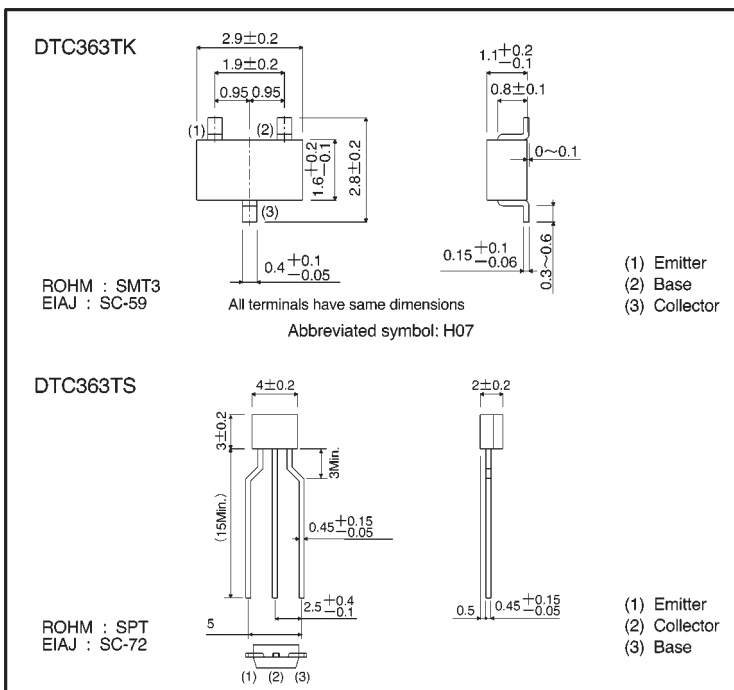

● Absolute maximum ratings (Ta = 25°C)

Parameter	Symbol	Limits(DTC363T□)		Unit
		K	S	
Collector-base voltage	V <sub>CBO</sub>	30		V
Collector-emitter voltage	V <sub>CEO</sub>	15		V
Emitter-base voltage	V <sub>EBO</sub>	5		V
Collector current	I <sub>C</sub>	600		mA
Collector power dissipation	P <sub>C</sub>	200	300	mW
Junction temperature	T <sub>j</sub>	150		°C
Storage temperature	T <sub>stg</sub>	-55~+150		°C

● Electrical characteristics (Ta = 25°C)

Parameter	Symbol	Min.	Typ.	Max.	Unit	Conditions
Collector-base breakdown voltage	BV <sub>CBO</sub>	30	—	—	V	I <sub>C</sub> =50 μA
Collector-emitter breakdown voltage	BV <sub>CEO</sub>	15	—	—	V	I <sub>C</sub> =1mA
Emitter-base breakdown voltage	BV <sub>EBO</sub>	5	—	—	V	I <sub>E</sub> =50 μA
Collector cutoff current	I <sub>CBO</sub>	—	—	0.5	μA	V <sub>CB</sub> =20V
Emitter cutoff current	I <sub>EBO</sub>	—	—	0.5	μA	V <sub>EB</sub> =4V
Collector-emitter saturation voltage	V <sub>CE(sat)</sub>	—	40	80	mV	I <sub>C</sub> /I <sub>B</sub> =50mA/2.5mA
DC current transfer ratio	h <sub>FE</sub>	100	250	600	—	V <sub>CE</sub> =5V, I <sub>C</sub> =50mA
Input resistance	R <sub>i</sub>	4.76	6.8	8.84	kΩ	—
Transition frequency	f <sub>r</sub>	—	200	—	MHz	V <sub>CE</sub> =10V, I <sub>E</sub> =-50mA, f=100MHz *
Output "ON" resistance	R <sub>on</sub>	—	1.25	—	Ω	V <sub>I</sub> =7V, R <sub>L</sub> =1kΩ, f=1kHz

\* Transition frequency of the device

● Packaging specifications

Part No.	Package	SMT3	SPT
	Packaging type	Taping	Taping
	Code	T146	TP
	Basic ordering unit (pieces)	3000	5000
DTC363TK		○	—
DTC363TS		—	○

● R<sub>on</sub> measurement circuit

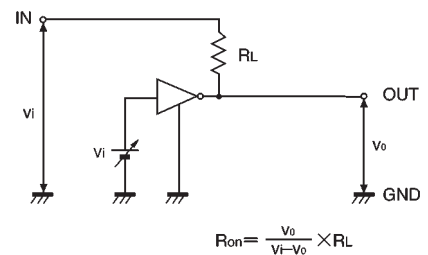

Fig.1 Input "on" resistance (R<sub>on</sub>) measurement circuit

● Electrical characteristic curves

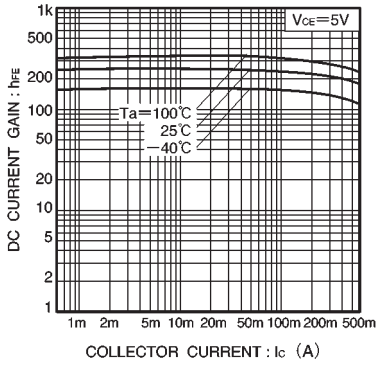

Fig.2 DC current gain vs. collector current

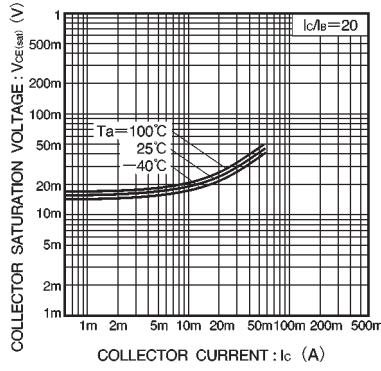

Fig.3 Collector-emitter saturation voltage vs. collector current

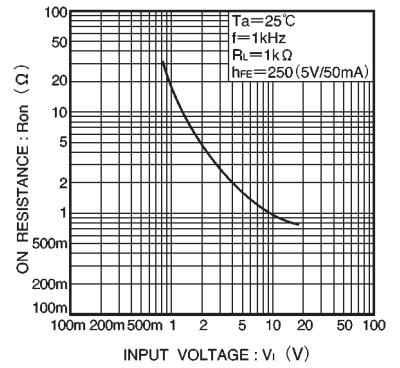



Fig.4 "ON" resistance vs. input voltage

## Looking for pricing, stock, or lifecycle information?

Click below to explore more details on WIN SOURCE:

-  [View DTC363TK T146 on WIN SOURCE](#)
-  [Rohm Semiconductor Information](#)

## Optimize Your Supply Chain with WIN SOURCE Solutions

-  Global Sourcing Solution
-  Obsolete Management
-  Cost Control Management
-  Shortage Management
-  Alternative Solution
-  Excess Inventory Management