



**THE DATASHEET OF
DX-5R5H224U**



5.5V Miniaturized Standard Capacitors

GREEN CAP 70°C

- Smaller and lighter than Series DB.
- 5mm tall. Max. thin profile (H-shaped).
- Miniaturized but can encase up to 0.47F in 11.5×5mm case, and 1.5F in φ19.0×20.5Lmm case.

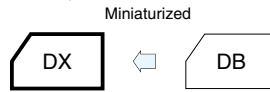

Marking color : White print on an indigo sleeve

Specifications

Item	Performance									
Category temperature range (°C)	-25 to +70									
Tolerance at rated capacitance (%)	-20 to +80									
Internal resistance at 1 kHz	Rated capacitance (F)	0.047	0.1	0.22	0.33	0.47	0.47	1	1.5	
	Internal resistance (Ω Max.)	120	75	75	75	75 (φ11.5)	30 (φ19.0)	30	30	
Characteristics at high and low temperature	Percentage of capacitance change	Within ±30% of the value at 20°C								
	Internal resistance	Less than five times of the value at 20°C								
Endurance (70°C)	Test time	1000 hours								
	Percentage of capacitance change	Within ±30% of the initial measured value								
	Internal resistance	Less than four times of the initial specified value								
Shelf life (70°C)	Test time : 1000 hours ; Same as endurance.									
Applicable standards	Conforms to JIS C5160-1 2009 (IEC 62391-1 2006)									

Outline Drawing

Unit : mm

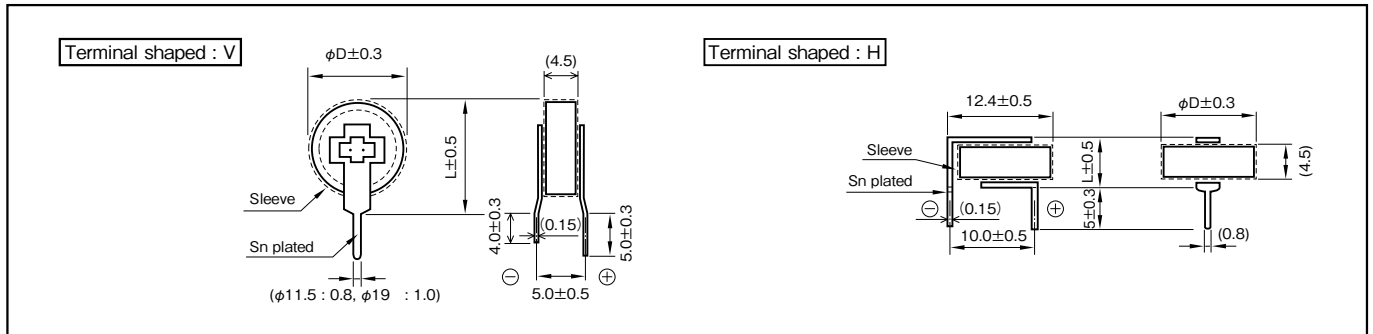

Part numbering system (example : 5.5V0.1F)						
DX	—	5R5	□	104	□	U
Series code		Max.operating voltage symbol	Terminal code	Rated capacitance symbol	Additional symbol	

Note

Do not apply external force to products or terminals as stress such as twisting, bending, pushing, or falling of such products or terminals may remove the terminals, resulting in an open/short circuit or liquid leakage. Avoid applying excessive heat to capacitors during heating of an adhesive curing oven. For details, refer to the precautions in use of DYNACAP.

Part number is refer to following table.

Standard Ratings

Max. operating voltage (V)	Rated capacitance (F)	ELNA Parts No.	φD×L (mm)
5.5	0.047	DX-5R5V473U	11.5×13.0
		DX-5R5H473U	11.5× 5.0
5.5	0.1	DX-5R5V104U	11.5×13.0
		DX-5R5H104U	11.5× 5.0
5.5	0.22	DX-5R5V224U	11.5×13.0
		DX-5R5H224U	11.5× 5.0
5.5	0.33	DX-5R5V334U	11.5×13.0
		DX-5R5H334U	11.5× 5.0
5.5	0.47	DX-5R5V474SU	11.5×13.0
		DX-5R5H474SU	11.5× 5.0
		DX-5R5V474U	19.0×20.5
5.5	1	DX-5R5V105U	19.0×20.5
5.5	1.5	DX-5R5V155U	19.0×20.5

NOTE : Design, Specifications are subject to change without notice. It is recommended that you shall obtain technical specifications from ELNA to ensure that the component is suitable for your use.

Looking for pricing, stock, or lifecycle information?

Click below to explore more details on WIN SOURCE:

 [View DX-5R5H224U on WIN SOURCE](#)

 [Elna America](#) Information

Optimize Your Supply Chain with WIN SOURCE Solutions

-  Global Sourcing Solution
-  Obsolete Management
-  Cost Control Management
-  Shortage Management
-  Alternative Solution
-  Excess Inventory Management