

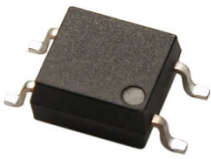

# THE DATASHEET OF EL357N-G



## 4 PIN SOP PHOTOTRANSISTOR PHOTOCOUPLER EL357N-G Series



Schematic

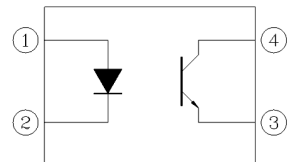

Pin Configuration

1. Anode
2. Cathode
3. Emitter
4. Collector

### Features:

- Halogens free
- Current transfer ratio  
(CTR: 50~600% at  $I_F = 5\text{mA}$ ,  $V_{CE} = 5\text{V}$ )
- High isolation voltage between input and output (Viso=3750 V rms )
- Compact 4 Pin SOP with a 2.0 mm profile
- Pb free and RoHS compliant.
- UL approved (No. E214129)
- VDE approved (No. 132249)
- SEMKO approved
- NEMKO approved
- DEMKO approved
- FIMKO approved
- CSA approved (No. 1408633)

### Description

The EL357N-G series contains an infrared emitting diode, optically coupled to a phototransistor detector.

The devices in a 4-pin small outline SMD package.

### Applications

- DC-DC Converters
- Programmable controllers
- Telecommunication equipments
- Signal transmission between circuits of different potentials and impedances

**Absolute Maximum Ratings (Ta=25°C)**

	Parameter	Symbol	Rating	Unit
Input	Forward current	$I_F$	50	mA
	Peak forward current (1 us, pulse)	$I_{FP}$	1	A
	Reverse voltage	$V_R$	6	V
	Power dissipation Derating factor (about Ta=100°C)	$P_D$	70 2.9	mW mW/°C
Output	Power dissipation Derating factor (above Ta = 70°C)	$P_C$	150 3.7	mW mW/°C
	Collector current	$I_C$	50	mA
	Collector-Emitter voltage	$V_{CEO}$	80	V
	Emitter-Collector voltage	$V_{ECO}$	7	V
	Total Power Dissipation	$P_{TOT}$	200	mW
Isolation Voltage*1	$V_{ISO}$	3750	V rms	
Operating temperature	$T_{OPR}$	-55 ~ +110	°C	
Storage temperature	$T_{STG}$	-55 ~ +125	°C	
Soldering Temperature*2	$T_{SOL}$	260	°C	

Notes:

\*1 AC for 1 minute, R.H.= 40 ~ 60% R.H. In this test, pins 1, 2 are shorted together, and pins 3, 4 are shorted together.

\*2 For 10 seconds

**Electro-Optical Characteristics (Ta=25°C unless specified otherwise)**

**Input**

Parameter	Symbol	Min.	Typ.	Max.	Unit	Condition
Forward voltage	$V_F$	-	1.2	1.4	V	$I_F = 20\text{mA}$
Reverse current	$I_R$	-	-	10	$\mu\text{A}$	$V_R = 4\text{V}$
Input capacitance	$C_{in}$	-	30	250	pF	$V = 0, f = 1\text{kHz}$

**Output**

Parameter	Symbol	Min	Typ.	Max.	Unit	Condition
Collector-Emitter dark current	$I_{CEO}$	-	-	100	nA	$V_{CE} = 20\text{V}, I_F = 0\text{mA}$
Collector-Emitter breakdown voltage	$BV_{CEO}$	80	-	-	V	$I_C = 0.1\text{mA}$
Emitter-Collector breakdown voltage	$BV_{ECO}$	7	-	-	V	$I_E = 0.01\text{mA}$

**Transfer Characteristics (Ta=25°C unless specified otherwise)**

Parameter	Symbol	Min	Typ.	Max.	Unit	Condition
Current Transfer ratio	EL357N	50	-	600	%	$I_F = 5\text{mA}, V_{CE} = 5\text{V}$
	EL357NA	80	-	160		
	EL357NB	130	-	260		
	EL357NC	200	-	400		
	EL357ND	300	-	600		
	EL357NE	100	-	200		
	EL357NF	150	-	300		
Collector-Emitter saturation voltage	$V_{CE(sat)}$	-	0.1	0.2	V	$I_F = 20\text{mA}, I_C = 1\text{mA}$
Isolation resistance	$R_{IO}$	$5 \times 10^{10}$	-	-	$\Omega$	$V_{IO} = 500\text{Vdc}, 40\sim 60\% \text{ R.H.}$
Floating capacitance	$C_{IO}$	-	0.6	1.0	pF	$V_{IO} = 0, f = 1\text{MHz}$
Rise time	$t_r$	-	3	18	$\mu\text{s}$	$V_{CE} = 2\text{V}, I_C = 2\text{mA}, R_L = 100\Omega$
Fall time	$t_f$	-	4	18		

\* Typical values at  $T_a = 25^\circ\text{C}$

Typical Electro-Optical Characteristics Curves

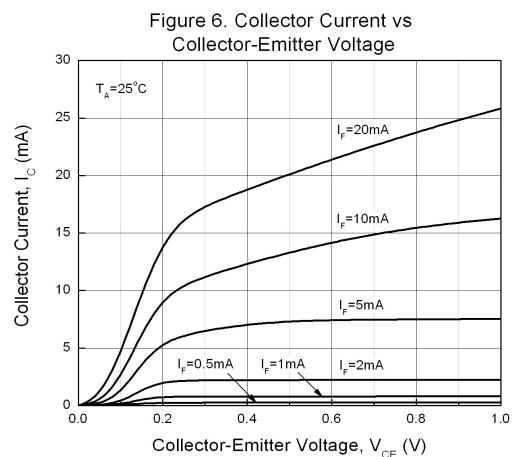
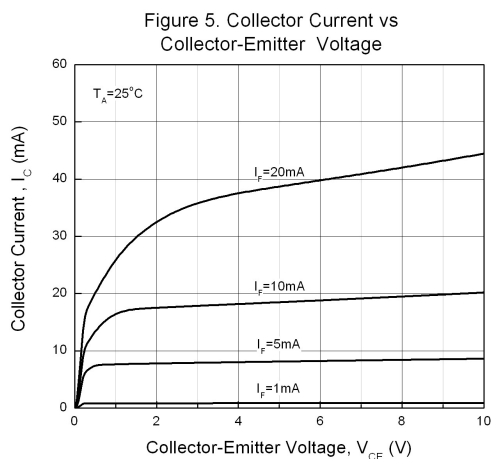
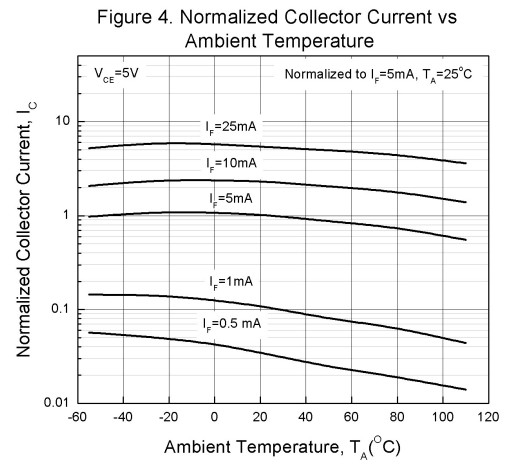
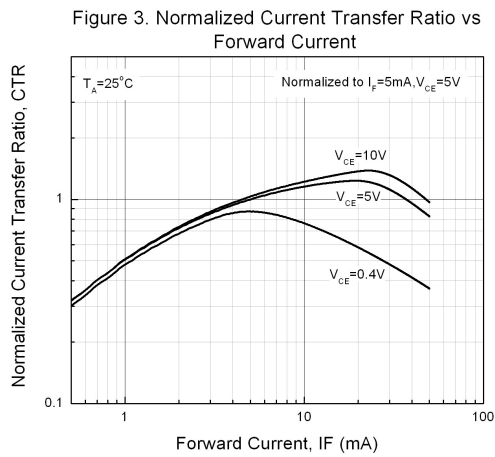
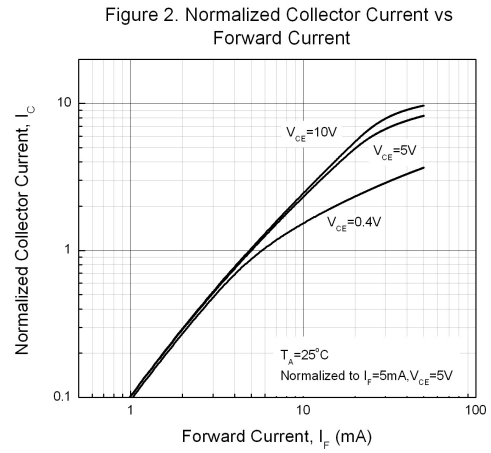
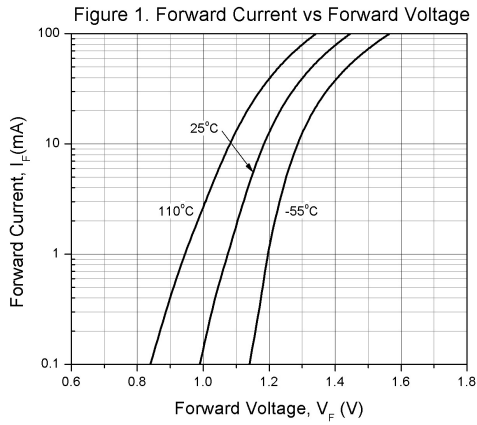

Figure 7. Collector Dark Current vs Ambient Temperature

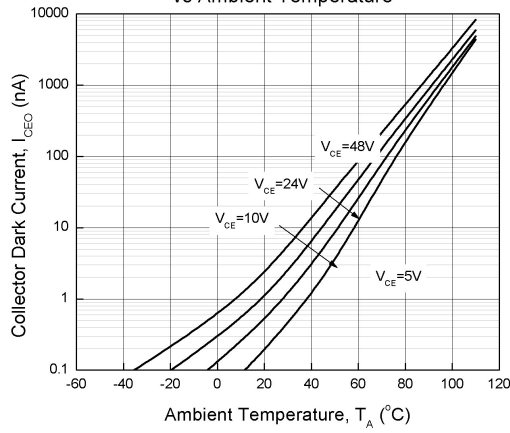

Figure 8. Switching Time vs Load Resistance

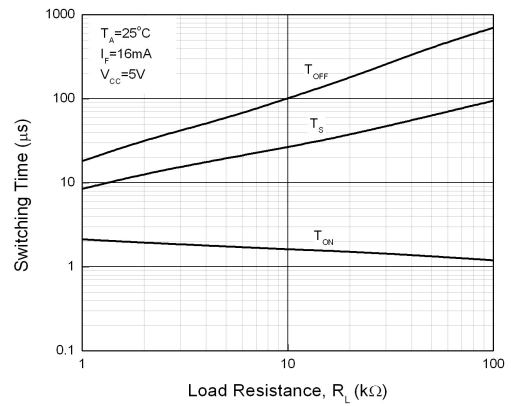

Figure 9. Collector-Emitter Saturation Voltage vs Ambient Temperature

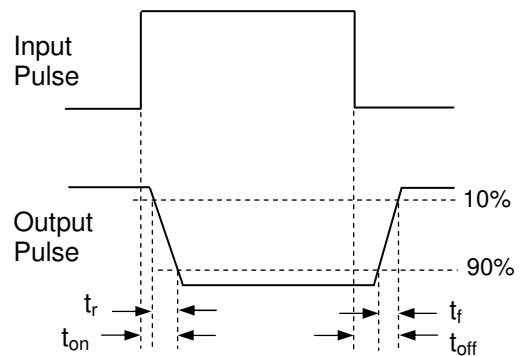
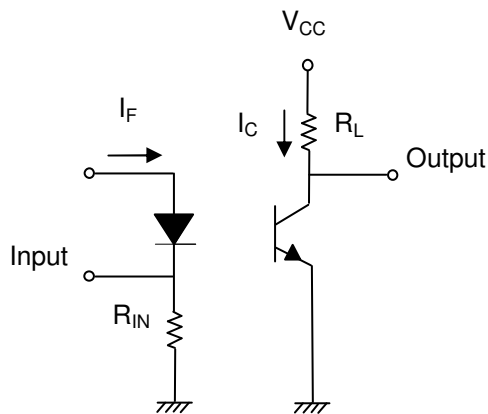
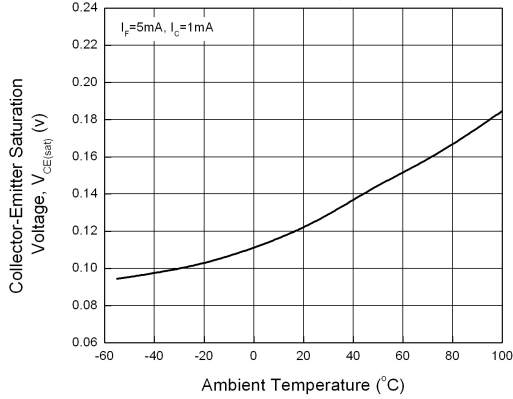

Figure 10. Switching Time Test Circuit & Waveforms

## Order Information

### Part Number

**EL357N(X)(Y)-VG**

### Note

- X = CTR Rank (A, B, C, D, E, For none)
- Y = Tape and reel option (TA, TB, or none).
- V = VDE (option)
- G = Halogens free

Option	Description	Packing quantity
None	Standard SMD option	100 units per tube
-V	Standard SMD option + VDE	100 units per tube
(TA)	TA Tape & reel option	3000 units per reel
(TB)	TB Tape & reel option	3000 units per reel
(TA)-V	TA Tape & reel option + VDE	3000 units per reel
(TB)-V	TB Tape & reel option + VDE	3000 units per reel

**Package Dimension (Dimensions in mm)**

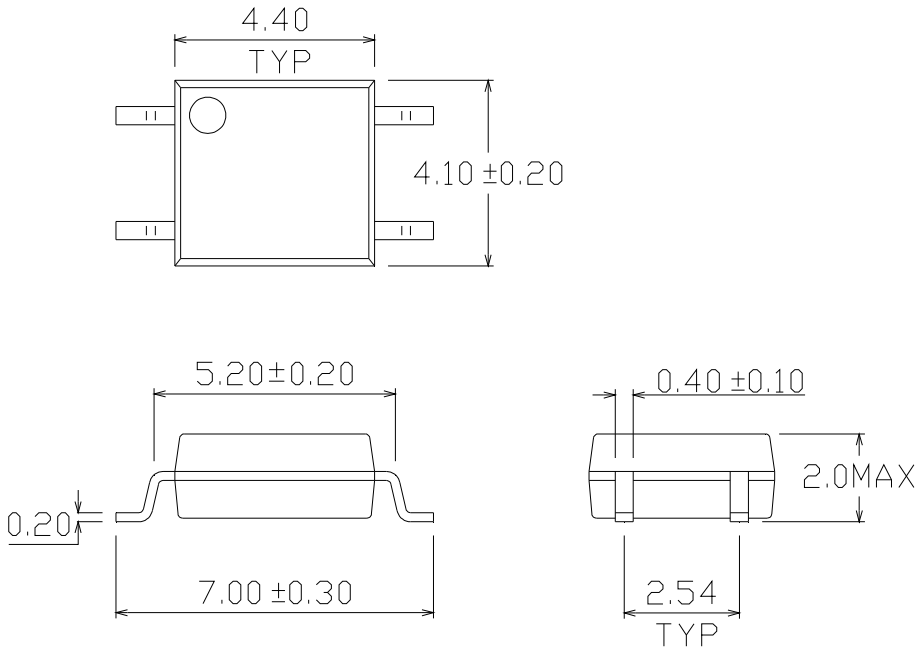

**Recommended pad layout for surface mount leadform**

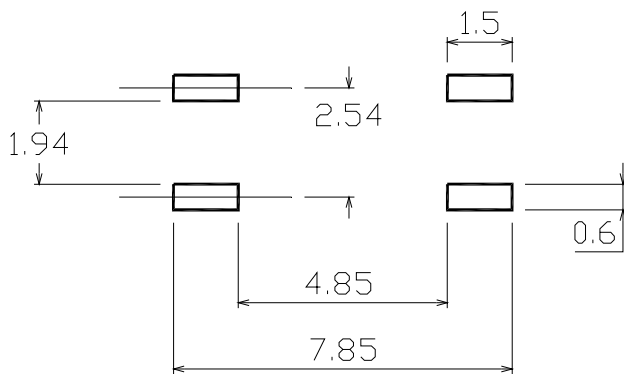

### Device Marking



### Notes

EL	denotes Everlight
357N	denotes Device Number
R	denotes CTR Rank
Y	denotes 1 digit Year code
WW	denotes 2 digit Week code
V	denotes VDE approved (optional)

**Tape & Reel Packing Specifications**

**Option TA**

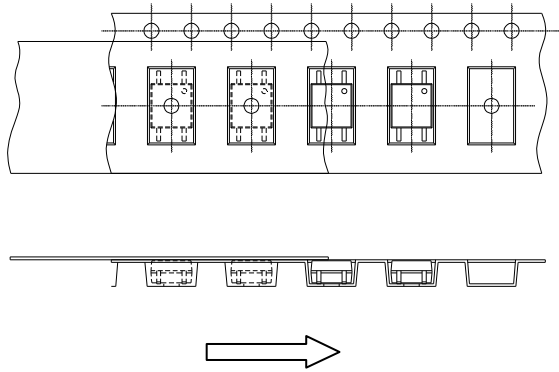

Direction of feed from reel

**Option TB**

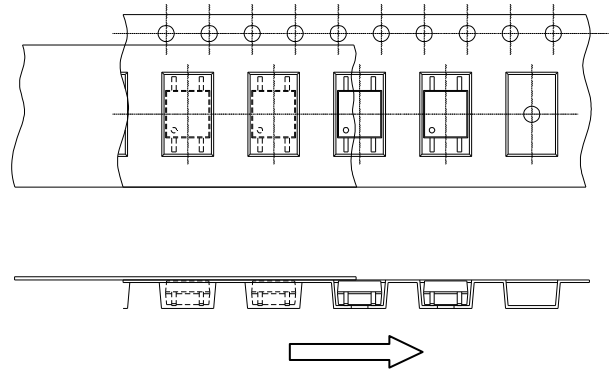

Direction of feed from reel

**Tape dimensions**

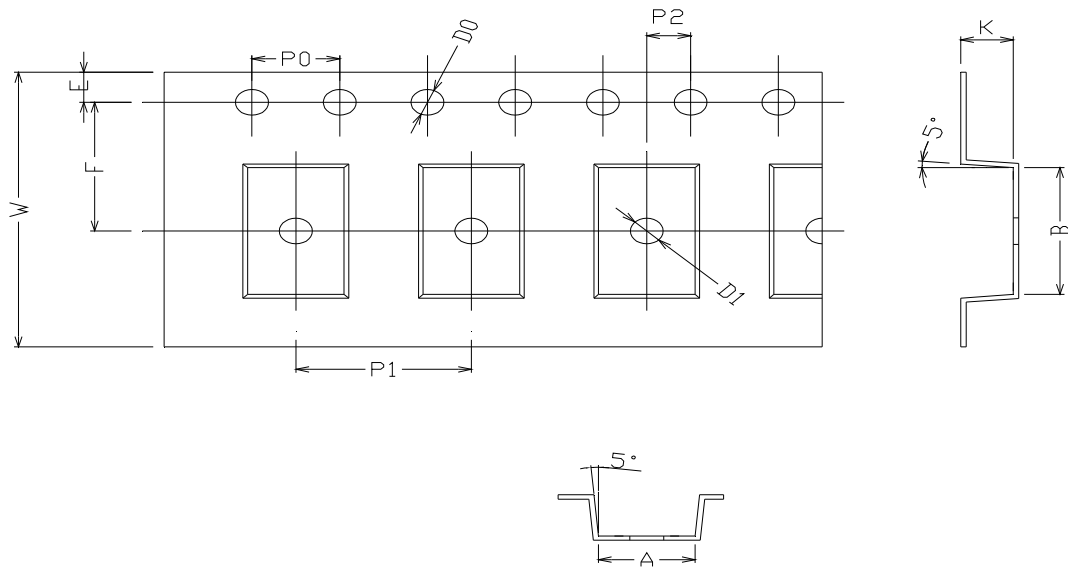

Dimension No.	<b>A</b>	<b>B</b>	<b>Do</b>	<b>D1</b>	<b>E</b>	<b>F</b>
Dimension (mm)	4.4 ± 0.1	7.4 ± 0.1	1.5 + 0.1/-0	1.5 ± 0.1	1.75 ± 0.1	7.5 ± 0.1
Dimension No.	<b>Po</b>	<b>P1</b>	<b>P2</b>	<b>t</b>	<b>W</b>	<b>K</b>
Dimension (mm)	4.0 ± 0.15	8.0 ± 0.1	2.0 ± 0.1	0.25 ± 0.03	16.0 ± 0.2	2.4 ± 0.1

## Precautions for Use

### 1. Soldering Condition

#### 1.1 (A) Maximum Body Case Temperature Profile for evaluation of Reflow Profile

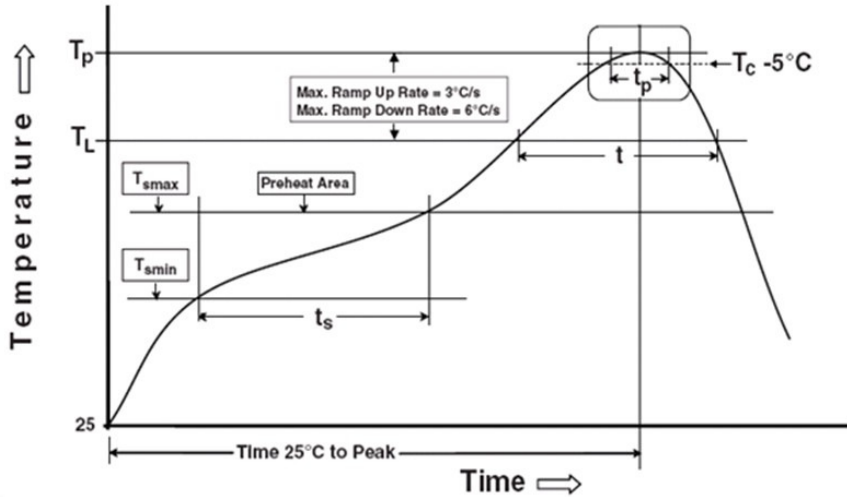

Note:

Reference: IPC/JEDEC J-STD-020D

#### Preheat

Temperature min ( $T_{smin}$ )	150 °C
Temperature max ( $T_{smax}$ )	200 °C
Time ( $T_{smin}$ to $T_{smax}$ ) ( $t_s$ )	60-120 seconds
Average ramp-up rate ( $T_{smax}$ to $T_p$ )	3 °C/second max

#### Other



Liquidus Temperature ( $T_L$ )	217 °C
Time above Liquidus Temperature ( $t_L$ )	60-100 sec
Peak Temperature ( $T_P$ )	260 °C
Time within 5 °C of Actual Peak Temperature: $T_P - 5^\circ\text{C}$	30 s
Ramp- Down Rate from Peak Temperature	6 °C /second max.
Time 25 °C to peak temperature	8 minutes max.
Reflow times	3 times

## **DISCLAIMER**

1. Above specification may be changed without notice. EVERLIGHT will reserve authority on material change for above specification.
2. When using this product, please observe the absolute maximum ratings and the instructions for using outlined in these specification sheets. EVERLIGHT assumes no responsibility for any damage resulting from use of the product which does not comply with the absolute maximum ratings and the instructions included in these specification sheets.
3. These specification sheets include materials protected under copyright of EVERLIGHT corporation. Please don't reproduce or cause anyone to reproduce them without EVERLIGHT's consent.

## Looking for pricing, stock, or lifecycle information?

Click below to explore more details on WIN SOURCE:

-  [View EL357N-G on WIN SOURCE](#)
-  [Everlight Electronics Co Ltd Information](#)

## Optimize Your Supply Chain with WIN SOURCE Solutions

-  Global Sourcing Solution
-  Obsolete Management
-  Cost Control Management
-  Shortage Management
-  Alternative Solution
-  Excess Inventory Management