



THE DATASHEET OF ELL-3GM4R3N



SMD Choke Coils

Singapore

Series: **M**

Type: **ELL3GM**



Type ELL3GM

■ Features

- Magnetic shielded structure
- Low DC resistance and large current capability
- Shock resistant
- Available on tape and reel for automatic insertion

■ Recommended Applications

- DC/DC converter circuitry for computer peripherals and cellular hand sets.
- Chopper circuit decoupling chokes in DC/DC converter circuitry.

■ Standard Packing Quantity

- 2000 pcs./Reel

■ Explanation of Part Numbers

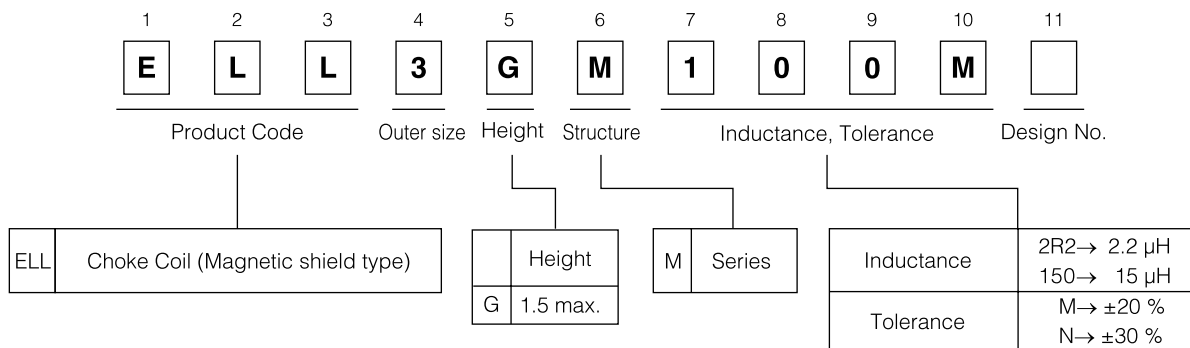

■ Dimensions in mm (not to scale)

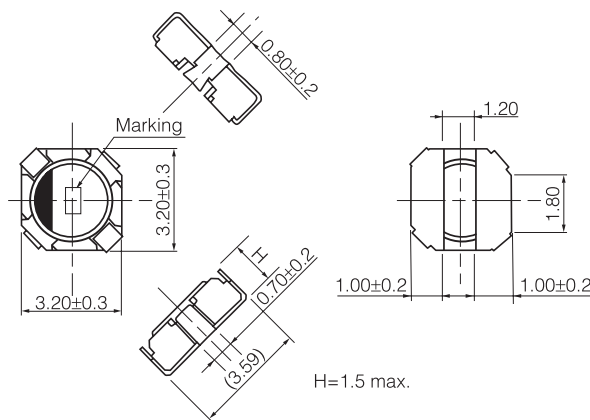

■ Recommended land patterns in mm (not to scale)

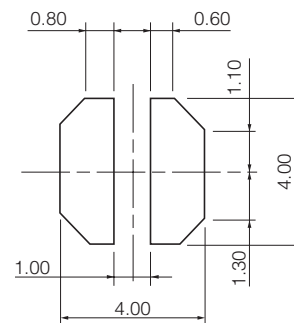

NEW

■ Standard Parts

Part Number	Inductance (100kHz)		Rbc (at 20 °C)		*Rated Current (mA max.)	Marking
	(μH)	Tol.	(mΩ)	Tol.		
ELL3GM2R2N	2.2	±30%	100	±20%	1100	C
ELL3GM2R7N	2.7		110		1000	D
ELL3GM3R3N	3.3		130		980	E
ELL3GM3R9N	3.9		140		940	F
ELL3GM4R3N	4.3		220		720	H
ELL3GM5R1N	5.1		240		690	I
ELL3GM5R6N	5.6		260		670	J
ELL3GM6R8N	6.8		280		650	K
ELL3GM8R2N	8.2		310		620	L
ELL3GM100M	10.0		±20%		350	550
ELL3GM120M	12.0	400		530	N	
ELL3GM150M	15.0	560		440	O	
ELL3GM180M	18.0	640		420	P	
ELL3GM220M	22.0	770		360	R	
ELL3GM270M	27.0	1050		330	S	
ELL3GM330M	33.0	1200		310	T	

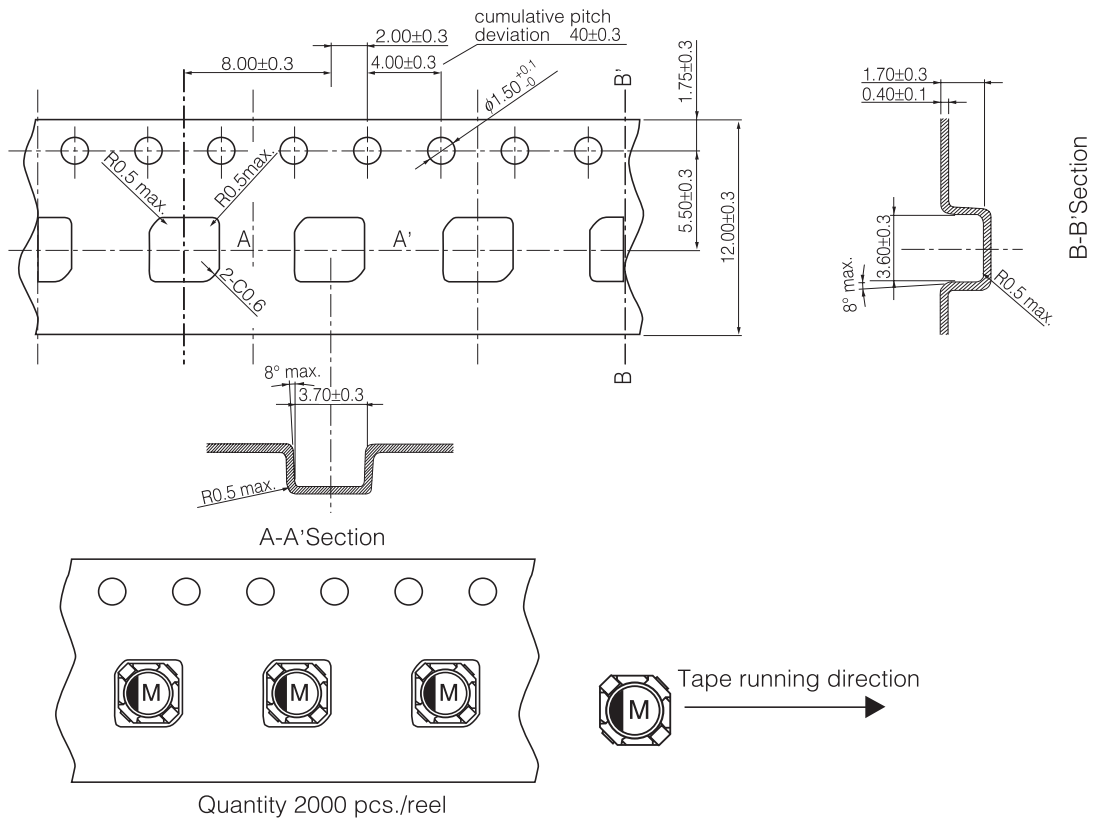

* Current: This indicates the value of current when the inductance is 70% of nominal value or when case temperature has risen 45 °C (at 20 °C)

■ Embossed Carrier Tape Dimensions in mm (not to scale)



Looking for pricing, stock, or lifecycle information?

Click below to explore more details on WIN SOURCE:

-  [View ELL-3GM4R3N on WIN SOURCE](#)
-  [Panasonic Information](#)

Optimize Your Supply Chain with WIN SOURCE Solutions

-  Global Sourcing Solution
-  Obsolete Management
-  Cost Control Management
-  Shortage Management
-  Alternative Solution
-  Excess Inventory Management