



10 Watt Zener Diodes

Qualified per MIL-PRF-19500/124

Qualified Levels:
JAN, JANTX, and
JANTXV

DESCRIPTION

The JEDEC registered 1N2970B through 1N3015B and 1N3993A through 1N3998A series are 10W Zener diodes with voltage regulation values between 3.9 and 200V. They are available in JAN, JANTX, and JANTXV military qualification grades on most voltage values.

Important: For the latest information, visit our website <http://www.microsemi.com>.

FEATURES

- Internal solder bond construction.
- Hermetically sealed (welded).
- Zener regulation voltages from 3.9 V to 200 V.
- Standard and reverse polarities are available.
- Consult factory for surface mount equivalents.
- JAN, JANTX, and JANTXV qualifications are available per MIL-PRF-19500/124.
- RoHS compliant devices available by adding "e3" suffix (commercial grade only).

APPLICATIONS / BENEFITS

- Regulates voltage over a broad range of current and temperature.
- Standard voltage tolerances are +/- 5%.
- Nonsensitive to ESD per MIL-STD-750 method 1020.
- Inherently radiation hard as described in Microsemi [MicroNote 050](#).

MAXIMUM RATINGS

Parameters/Test Conditions	Symbol	Value	Unit
Junction Temperature	T _J	-65 to +175	°C
Storage Temperature	T _{STG}	-65 to +200	°C
Thermal Resistance Junction-to-Case	R _{θJC}	12	°C/W
Steady-State Power Dissipation @ T _C = +55 °C ⁽¹⁾	P _D	10	W
Forward Voltage @ 2.0 A	V _F	1.5	V
Solder Pad Temperature @ 10 s	T _{SP}	260	°C

NOTES: 1. Derate at 0.083 W/°C above +55 °C.



**DO-213AA (DO-4)
Package**

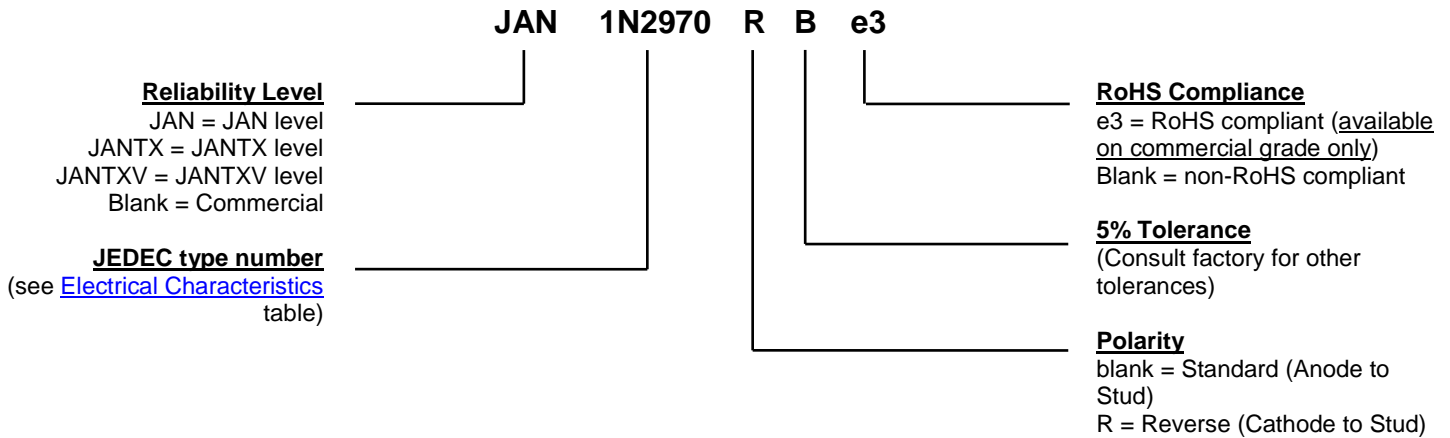
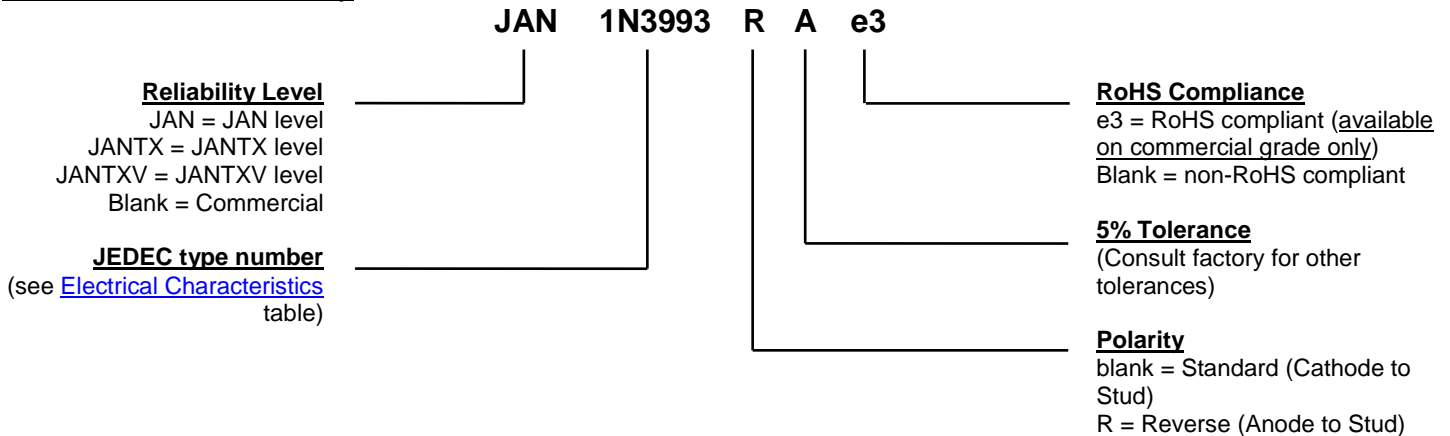
MSC – Lawrence
6 Lake Street,
Lawrence, MA 01841
Tel: 1-800-446-1158
(978) 620-2600
Fax: (978) 689-0803

MSC – Ireland
Gort Road Business Park,
Ennis, Co. Clare, Ireland
Tel: +353 (0) 65 6840044
Fax: +353 (0) 65 6822298

Website:
www.microsemi.com

MECHANICAL and PACKAGING

- CASE: Industry standard DO-4, (DO-203AA), 7/16" hex, stud with 10-32 threads, welded, hermetically sealed metal and glass.
- TERMINALS: Tin-lead plated or RoHS compliant matte-tin plating (commercial grade only) on nickel.
- POLARITY: **1N2970B – 1N3015B**: Std. Polarity is anode to stud. Reverse polarity (cathode to stud) indicated by suffix "RB".
1N3993A – 1N3998A: Std. Polarity is cathode to stud. Reverse polarity (anode to stud) indicated by suffix "RA".
- MOUNTING HARDWARE: Consult factory for optional insulator, bushing solder terminal, washers, and nut.
- WEIGHT: Approximately 7.5 grams.
- See [Package Dimensions](#) on last page.

PART NOMENCLATURE
1N2970 – 1N3015 series only:

1N3993 – 1N3998 series only:


SYMBOLS & DEFINITIONS	
Symbol	Definition
I_{ZT}	Regulator Current: The dc regulator current (I_Z), at a specified test point (I_{ZT}), near breakdown knee (I_{ZK}).
I_R	Reverse Current: The maximum reverse (leakage) current that will flow at the specified voltage and temperature.
I_{ZM}	Maximum Regulator (Zener) Current: The maximum rated dc current for the specified power rating.
V_F	Maximum Forward Voltage: The maximum forward voltage the device will exhibit at a specified current.
V_R	Reverse Voltage: The reverse voltage dc value, no alternating component.
V_Z	Zener Voltage: The Zener voltage the device will exhibit at a specified current (I_Z) in its breakdown region.
Z_{ZT} or Z_{ZK}	Dynamic Impedance: The small signal impedance of the diode when biased to operate in its breakdown region at a specified rms current modulation (typically 10% of I_{ZT} or I_{ZK}) and superimposed on I_{ZT} or I_{ZK} respectively.

ELECTRICAL CHARACTERISTICS

JEDEC TYPE NO. (Note 1)	NOMINAL ZENER VOLTAGE $V_Z @ I_{ZT}$ (Note 2)	ZENER TEST CURRENT (I_{ZT}) mA	MAX. DYNAMIC IMPEDANCE (Note 3)		MAX DC ZENER CURRENT (I_{ZM}) @ 25°C Stud Temp. (Note 4)	TEMP. COEFF. α_{VZ} %/°C	MAX** REVERSE CURRENT		POLARITY
			$Z_{ZT} @ I_{ZT}$ Ohms	$Z_{ZK} @ 1mA (I_{ZK})$ Ohms			$I_R @ V_R$ μA	Volts	
†1N3993A	3.9	640	2.0	400	2440	-0.060	100	0.5	STD. POLARITY CATHODE TO STUD
†1N3994A	4.3	580	1.5	400	2200	-0.050	100	0.5	
†1N3995A	4.7	530	1.2	550	2000	+0.025	50	1.0	
†1N3996A	5.1	490	1.1	550	1840	+0.030	10	1.0	
†1N3997A	5.6	445	1.0	600	1680	+0.040	10	1.0	
†1N3998A	6.2	405	1.1	700	1520	+0.045	10	2.0	
†1N2970B	6.8	370	1.2	500	1500	+0.057	150	5.2	STD. POLARITY ANODE TO STUD
†1N2971B	7.5	335	1.3	250	1350	+0.067	100	5.7	
†1N2972B	8.2	305	1.5	250	1180	+0.070	50	6.2	
†1N2973B	9.1	275	2.0	250	1100	+0.075	25	6.9	
†1N2974B	10	250	3	250	980	+0.081	25	7.6	
†1N2975B	11	230	3	250	890	+0.085	10	8.4	
†1N2976B	12	210	3	250	820	+0.079	10	9.1	
†1N2977B	13	190	3	250	750	+0.080	10	9.9	
1N2978B	14	180	3	250	600	+0.070	10	10.5	
†1N2979B	15	170	3	250	640	+0.082	10	11.4	
†1N2980B	16	155	4	250	605	+0.083	10	12.2	
1N2981B	17	145	4	250	500	+0.075	10	13.0	
†1N2982B	18	140	4	250	525	+0.085	10	13.7	
1N2983B	19	130	4	250	440	+0.075	10	14.0	
†1N2984B	20	125	4	250	480	+0.086	10	15.2	
†1N2985B	22	115	5	250	435	+0.087	10	16.7	
†1N2986B	24	105	5	250	400	+0.088	10	18.2	
1N2987B	25	100	6	250	310	+0.080	10	18.2	
†1N2988B	27	95	7	250	340	+0.090	10	20.6	
†1N2989B	30	85	8	300	320	+0.091	10	22.8	
†1N2990B	33	75	9	300	300	+0.092	10	25.1	
†1N2991B	36	70	10	300	260	+0.093	10	27.4	
†1N2992B	39	65	11	300	240	+0.094	10	29.7	
†1N2993B	43	60	12	400	220	+0.095	10	32.7	
1N2994B	45	55	13	400	185	+0.090	10	33.0	
†1N2995B	47	55	14	400	200	+0.095	10	35.8	
1N2996B	50	50	15	500	165	+0.090	10	36.0	
†1N2997B	51	50	15	500	185	+0.096	10	38.8	
1N2998B	52	50	15	500	160	+0.090	10	39.0	
†1N2999B	56	45	16	500	170	+0.096	10	42.6	
†1N3000B	62	40	17	600	150	+0.097	10	47.1	
†1N3001B	68	37	18	600	137	+0.097	10	51.7	
†1N3002B	75	33	22	600	125	+0.098	10	56.0	
†1N3003B	82	30	25	700	115	+0.098	10	62.2	
†1N3004B	91	28	35	800	97	+0.099	10	69.2	
†1N3005B	100	25	40	900	91	+0.110	10	76.0	
1N3006B	105	25	45	1000	75	+0.095	10	76.0	
†1N3007B	110	23	55	1100	82	+0.110	10	83.6	
†1N3008B	120	20	75	1200	77	+0.110	10	91.2	
†1N3009B	130	19	100	1300	71	+0.110	10	98.8	
1N3010B	140	18	125	1400	58	+0.095	10	100.0	
†1N3011B	150	17	175	1500	62	+0.110	10	114.0	
†1N3012B	160	16	200	1600	58	+0.110	10	121.6	
1N3013B	175	14	250	1750	46	+0.095	10	135.0	
†1N3014B	180	14	260	1850	52	+0.110	10	136.8	
†1N3015B	200	12	300	2000	46	+0.110	10	152.0	

* JEDEC Registered Data.

** Not JEDEC Data.

† Have JAN, JANTX and JANTXV qualifications to MIL-PRF-19500/124.

See further notes on following page.

NOTES:

1. 1N3993A - 1N3998A and 1N2970B – 1N3015B series are +/- 5% tolerance. If a tighter tolerance is required, consult factory.
2. The electrical characteristics are measured after allowing the device to stabilize for 90 seconds with 30 °C base temperature.
3. The Zener impedance (Z_{ZT}) is derived from the 60 Hz ac voltage, which results when an ac current having an rms value equal to 10% of the dc Zener current (I_{ZT} or I_{ZK}) is superimposed on I_{ZT} or I_{ZK} . When making Zener impedance measurements at the I_{ZK} test point, it may be necessary to insert a 60 Hz band pass filter between the diode and voltmeter to avoid errors resulting from low level noise signals. A curve showing the variation of Zener impedance vs. Zener current for three representative types is shown in [Figures 2 and 3](#). Also see Microsemi [MicroNote 202](#).
4. Derate I_Z linearly to 0.0 mA at +175°C, for $T_C > +55^\circ\text{C}$. These values of I_{ZM} may be exceeded in the case of individual diodes. The values shown are calculated for the worst case that is a unit of +/-5% tolerance at the high voltage end of its tolerance range. Allowance has also been made for the rise in Zener voltage above V_{ZT} , which results from Zener impedance and the increase in junction temperature as power dissipation approaches 10 watts.

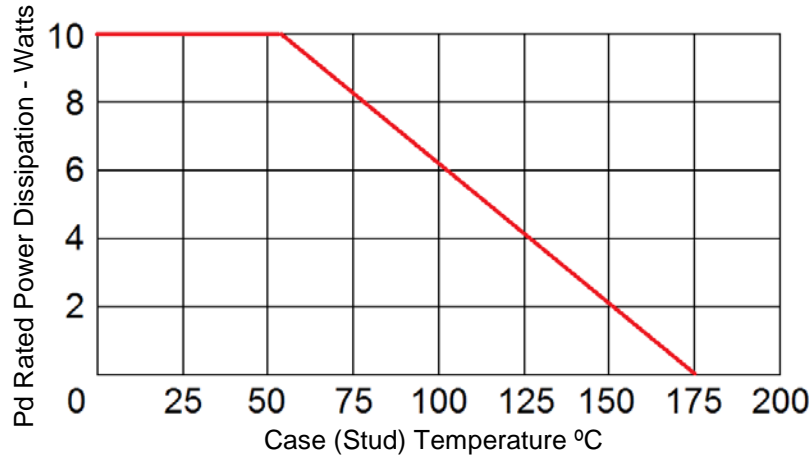
GRAPHS


FIGURE 1
Power Derating Curve

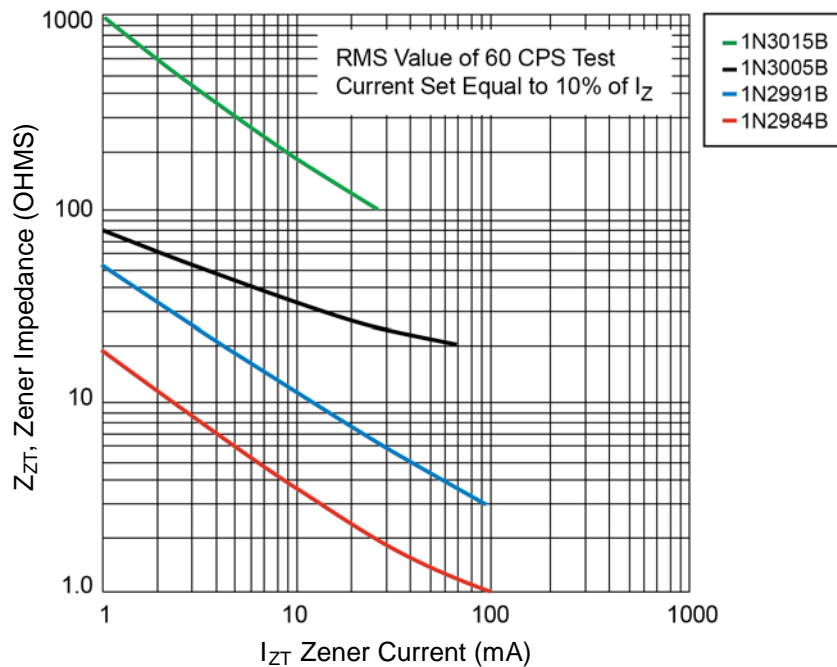


FIGURE 2
Typical Zener Impedance vs. Zener Current for Types Shown

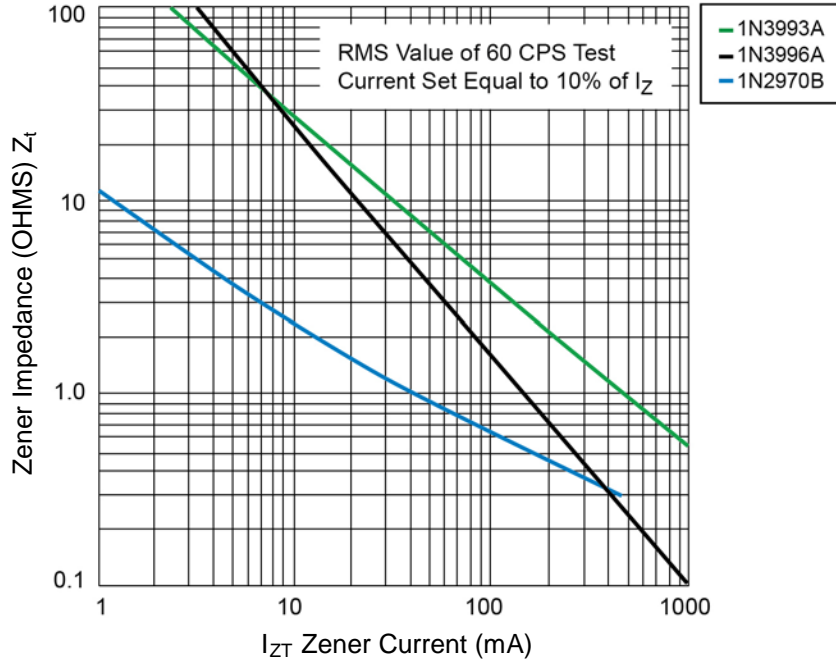
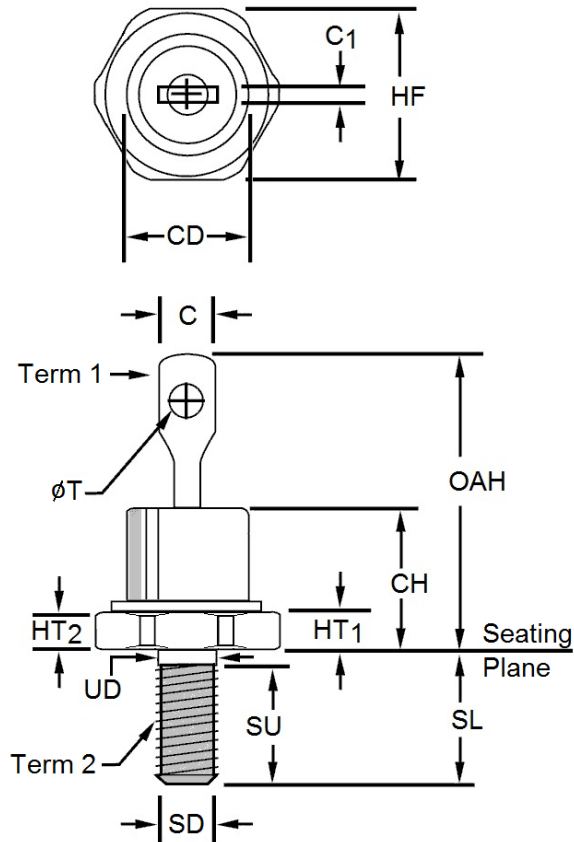
GRAPHS (continued)


FIGURE 3
Typical Zener Impedance vs Zener Current for Types Shown

PACKAGE DIMENSIONS




Ltr	Dimensions				Notes
	Inches		Millimeters		
	Min	Max	Min	Max	
C	-	0.250	-	6.35	5
C₁	0.012	0.065	0.30	1.65	5
CD	0.255	0.424	6.48	10.77	6
CH	0.300	0.405	7.62	10.29	
HF	0.424	0.437	10.77	11.1	6
HT₁	0.075	0.175	1.91	4.45	7
HT₂	0.060	0.175	1.52	4.45	7
OAH	0.600	0.800	15.24	20.32	
SD	-	-	-	-	2
SL	0.422	0.453	10.72	11.51	
SU	-	0.078	-	1.98	
UD	0.163	0.189	4.14	4.80	8
ΦT	0.060	0.095	1.52	2.41	

NOTES:

1. Dimensions are in inches. Millimeters are given for information only.
2. See "[Mechanical and Packaging](#)" for the polarity of the terminals.
3. Threads shall be 10–32 UNF–2A in accordance with FED–STD–H28. Maximum pitch diameter (SD) of plated threads is 0.1697 inch (4.31 mm).
4. Maximum torque allowed on the 10–32 UNF–2B nut when assembled on the thread is 15 inch-pounds.
5. The angular orientation and peripheral configuration of terminal 1 is undefined, however, the major surfaces over dimension C and C₁ shall be flat.
6. Dimension CD cannot exceed dimension HF.
7. A chamfer or undercut on one or both ends of the hex portion is optional; minimum base diameter at the seating plane is 0.403 inch (10.24 mm).
8. Length of incomplete or undercut threads UD.
9. In accordance with ASME Y14.5M, diameters are equivalent to Φx symbology.

Looking for pricing, stock, or lifecycle information?

Click below to explore more details on WIN SOURCE:

-  [View 1N3004B on WIN SOURCE](#)
-  [Microsemi Corporation](#) Information

Optimize Your Supply Chain with WIN SOURCE Solutions

-  Global Sourcing Solution
-  Obsolete Management
-  Cost Control Management
-  Shortage Management
-  Alternative Solution
-  Excess Inventory Management