



**THE DATASHEET OF  
EMI7208MUTAG**



# EMI7204MU, EMI7206MU, EMI7208MU



ON Semiconductor®

<http://onsemi.com>

## Four-Six-Eight -Channel EMI Filter with Integrated ESD Protection

The EMI720xMU Series is a family of LC EMI filters with integrated ESD protection. Its typical component values of  $L = 17$  nH and  $C = 12$  pF deliver a cutoff frequency of 250 MHz and stop band attenuation greater than  $-23$  dB from 800 MHz to 6.0 GHz.

This performance makes the part ideal for parallel interfaces with data rates up to 125 Mbps in applications where wireless interference must be minimized. The specified attenuation range is very effective in minimizing interference from 2G/3G, GPS, Bluetooth® and WLAN signals.

The EMI720xMU Series is available in the low-profile 4, 6, and 8 lead, 0.5 mm thick UDFN surface mount packages with 0.4 mm lead pitch.

### Features/Benefits

- $\pm 16$  kV ESD Protection on Each Channel (IEC61000-4-2 Level 4, Contact Discharge)
- L/C Values of 17 nH and 12 pF Deliver Exceptional S21 Performance Characteristics of 250 MHz  $f_{3dB}$  and  $-23$  dB Stop Band Attenuation from 800 MHz to 6.0 GHz
- Integrated EMI/ESD System Solution in UDFN Package Offers Exceptional Cost, System Reliability and Space Savings
- These are Pb-Free Devices

### Applications

- Wireless Handsets
- EMI Filtering for LCD and Camera Data Lines
- EMI Filtering and Protection for I/O Ports and Keypads

### MARKING DIAGRAMS



UDFN8  
CASE 517BC

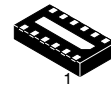
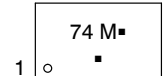

UDFN12  
CASE 517BD

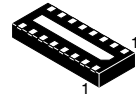
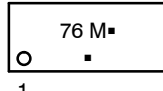

UDFN16  
CASE 517BE

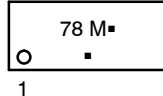

XX = Specific Device Code  
M = Date Code  
▪ = Pb-Free Package

(Note: Microdot may be in either location)

### ORDERING INFORMATION

See detailed ordering and shipping information in the package dimensions section on page 4 of this data sheet.

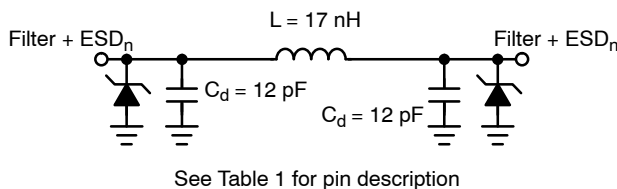

Figure 1. Electrical Schematic

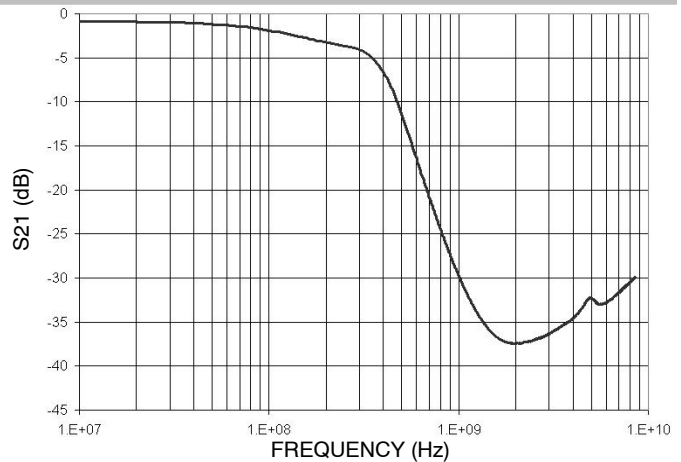
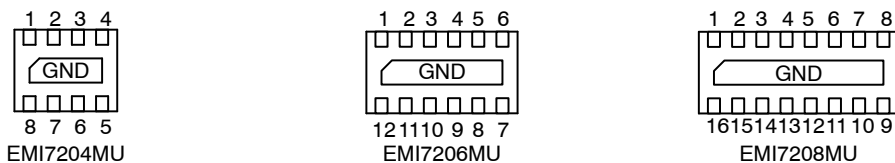

Figure 2. Typical Insertion Loss Curve

# EMI7204MU, EMI7206MU, EMI7208MU



**Figure 3. Pin Diagram**  
(Bottom View)

**Table 1. FUNCTIONAL PIN DESCRIPTION**

Filter	Device Pins			Description
	EMI7204MU	EMI7206MU	EMI7208MU	
Filter 1	1 & 8	1 & 12	1 & 16	Filter + ESD Channel 1
Filter 2	2 & 7	2 & 11	2 & 15	Filter + ESD Channel 2
Filter 3	3 & 6	3 & 10	3 & 14	Filter + ESD Channel 3
Filter 4	4 & 5	4 & 9	4 & 13	Filter + ESD Channel 4
Filter 5		5 & 8	5 & 12	Filter + ESD Channel 5
Filter 6		6 & 7	6 & 11	Filter + ESD Channel 6
Filter 7			7 & 10	Filter + ESD Channel 7
Filter 8			8 & 9	Filter + ESD Channel 8
Ground Pad	GND	GND	GND	Ground

**MAXIMUM RATINGS** ( $T_J = 25^\circ\text{C}$  unless otherwise noted)

Parameter	Symbol	Value	Unit
ESD IEC61000-4-2 (Contact Discharge)	$V_{PP}$	$\pm 16$	kV
ESD Human Body Model MIL-STD--883	$V_{PP}$	$\pm 16$	kV
Operating Temperature Range	$T_{OP}$	-40 to 85	$^\circ\text{C}$
Storage Temperature	$T_{STG}$	-65 to 150	$^\circ\text{C}$
Maximum Lead Temperature for Soldering Purpose (1.8 in from case for 10 seconds)	$T_L$	260	$^\circ\text{C}$
Current per inductor	$I_C$	30	mA
DC package power rating	$P_p$	500	mW

Stresses exceeding Maximum Ratings may damage the device. Maximum Ratings are stress ratings only. Functional operation above the Recommended Operating Conditions is not implied. Extended exposure to stresses above the Recommended Operating Conditions may affect device reliability.

**ELECTRICAL CHARACTERISTICS** ( $T_J = 25^\circ$  unless otherwise noted).

Parameter	Symbol	Test Conditions	Min	Typ	Max	Unit
Maximum reverse Working Voltage	$V_{RWM}$				5.0	V
Breakdown Voltage Positive Clamp	$V_{BR}$	$I_R = 1.0 \text{ mA}$	5.6	6.8	9.0	V
Breakdown Voltage Negative Clamp	$V_{BR}$	$I_R = 1.0 \text{ mA}$	-1.5	-0.08	-0.04	V
Leak Current	$I_R$	$V_{RWM} = 3.3 \text{ V}$		0.1	1.0	$\mu\text{A}$
Resistance	$R_A$			10		$\Omega$
Inductance	L			17		nH
Diode Capacitance	$C_1$	$V_R = 2.5 \text{ V}, f = 1.0 \text{ MHz}, 30 \text{ mVAC}$		12		pF
Line Capacitance	$C_t$		18.8	24.2	28.2	pF
3dB Cut-Off Frequency (Note 1)	$f_{3dB}$	Above this frequency, appreciable attenuation occurs		250		MHz
Stop Band Attenuation		800 MHz to 6.0 GHz		23		dB

1. 50  $\Omega$  source and 50  $\Omega$  load termination.

**Theory of Operation**

The EMI720X combines ESD protection and EMI filtering conveniently into a small package for today’s size constrained applications. The capacitance inherent to a typical protection diode is utilized to provide the capacitance value necessary to create the desired frequency response based upon the series resistance in the filter. By combining this functionality into one device, a large number of discrete components are integrated into one small package saving valuable board space and reducing BOM count and cost in the application.

**Application Example**

The accepted practice for specifying bandwidth in a filter is to use the 3 dB cutoff frequency. Utilizing points such as the 6 dB or 9 dB cutoff frequencies results in signal degradation in an application. This can be illustrated in an application example. A typical application would include EMI filtering of data lines in a camera or display interface. In such an example it is important to first understand the signal and its spectral content. By understanding these things, an appropriate filter can be selected for the desired application. A typical data signal is pattern of 1’s and 0’s transmitted over a line in a form similar to a square wave. The maximum frequency of such a signal would be the pattern 1-0-1-0 such that for a signal with a data rate of 100 Mbps, the maximum frequency component would be 50 MHz. The next item to consider is the spectral content of the signal, which can be understood with the Fourier series approximation of a square wave, shown below in Equations 1 and 2 in the Fourier series approximation.

From this it can be seen that a square wave consists of odd order harmonics and to fully construct a square wave n must go to infinity. However, to retain an acceptable portion of the waveform, the first two terms are generally sufficient. These two terms contain about 85% of the signal amplitude and allow a reasonable square wave to be reconstructed. Therefore, to reasonably pass a square wave of frequency x the minimum filter bandwidth necessary is 3x. All ON Semiconductor EMI filters are rated according to this principle. Attempting to violate this principle will result in significant rounding of the waveform and cause problems in transmitting the correct data. For example, take the filter with the response shown in Figure 4 and apply three different data waveforms. To calculate these three different frequencies, the 3 dB, 6 dB, and 9 dB bandwidths will be used.

**Equation 1:**

$$x(t) = \frac{1}{2} + \frac{2}{\pi} \sum_{n=1}^a \left[ \frac{1}{2n-1} \sin((2n-1)\omega_0 t) \right] \quad (\text{eq. 1})$$

**Equation 2 (Simplified form of Equation 1):**

$$x(t) = \frac{1}{2} + \frac{2}{\pi} \left[ \frac{\sin(\omega_0 t)}{1} + p20 \frac{\sin(3\omega_0 t)}{3} + p20 \frac{\sin(5\omega_0 t)}{5} + \dots \right] \quad (\text{eq. 2})$$

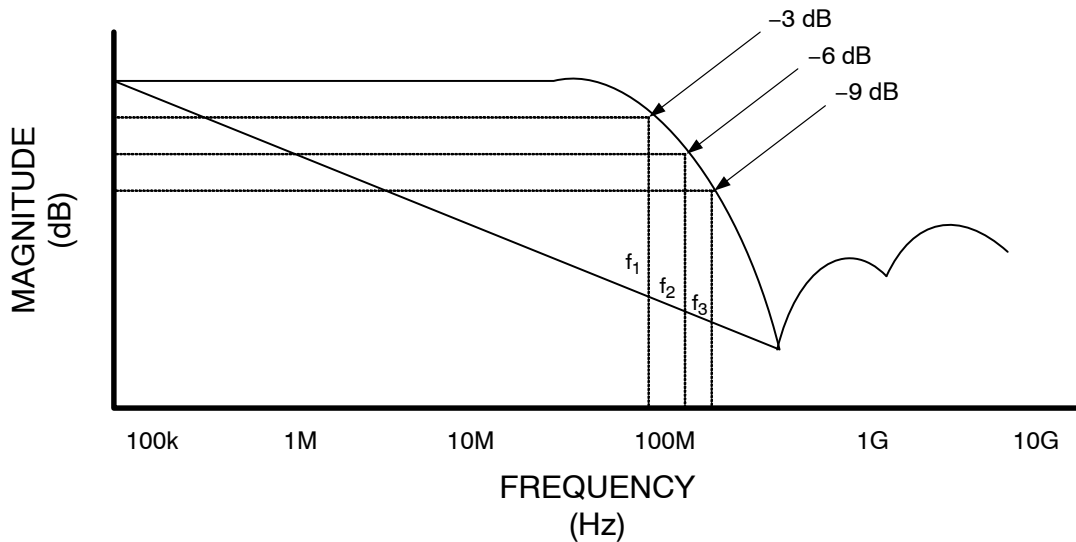

**Figure 4. Filter Bandwidth**

From the above paragraphs it is shown that the maximum supported frequency of a waveform that can be passed through the filter can be found by dividing the bandwidth by a factor of three (to obtain the corresponding data rate

multiply the result by two). The following table gives the bandwidth values and the corresponding maximum supported frequencies and the third harmonic frequencies.

## EMI7204MU, EMI7206MU, EMI7208MU

**Table 2. FREQUENCY CHART**

Bandwidth	Maximum Supported Frequency	Third Harmonic Frequency
3 dB – 100 MHz	33.33 MHz ( $f_1$ )	100 MHz
6 dB – 200 MHz	66.67 MHz ( $f_2$ )	200 MHz
9 dB – 300 MHz	100 MHz ( $f_3$ )	300 MHz

Considering that 85% of the amplitude of the square is in the first two terms of the Fourier series approximation most of the signal content is at the fundamental (maximum supported) frequency and the third harmonic frequency. If a signal with a frequency of 33.33 MHz is input to this filter, the first two terms are sufficiently passed such that the signal is only mildly affected, as is shown in Figure 5a. If a signal with a frequency of 66.67 MHz is input to this same filter,

the third harmonic term is significantly attenuated. This serves to round the signal edges and skew the waveform, as is shown in Figure 5b. In the case that a 100 MHz signal is input to this filter, the third harmonic term is attenuated even further and results in even more rounding of the signal edges as is shown in Figure 5c. The result is the degradation of the data being transmitted making the digital data (1's and 0's) more difficult to discern. This does not include effects of other components such as interconnect and other path losses which could further serve to degrade the signal integrity. While some filter products may specify the 6 dB or 9 dB bandwidths, actually using these to calculate supported frequencies (and corresponding data rates) results in significant signal degradation. To ensure the best signal integrity possible, it is best to use the 3 dB bandwidth to calculate the achievable data rate.

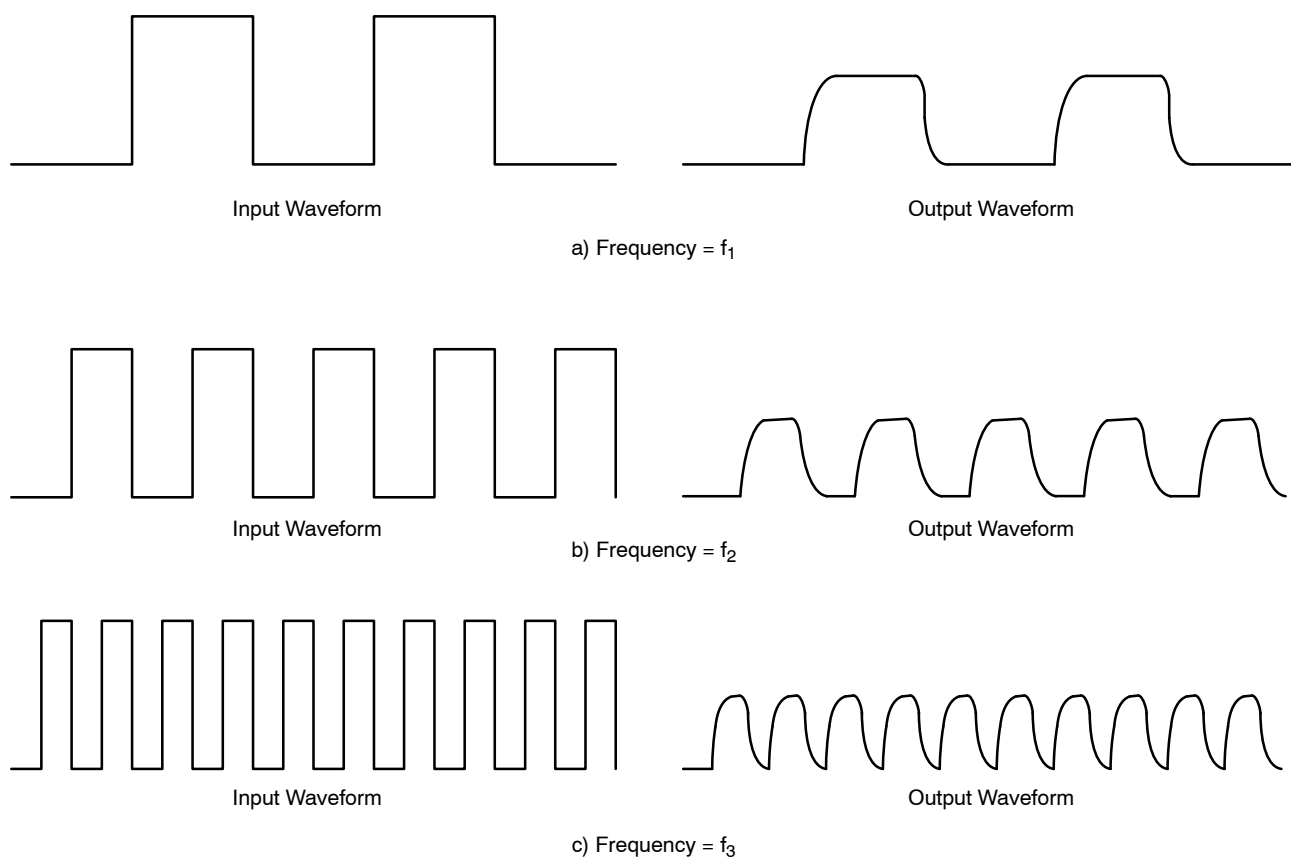

**Figure 5. Input and Output Waveforms of Filter**

### ORDERING INFORMATION

Device	Package	Shipping†
EMI7204MUTAG	UDFN8 (Pb-Free)	3000 / Tape & Reel
EMI7206MUTAG	UDFN12 (Pb-Free)	3000 / Tape & Reel
EMI7208MUTAG	UDFN16 (Pb-Free)	3000 / Tape & Reel

†For information on tape and reel specifications, including part orientation and tape sizes, please refer to our Tape and Reel Packaging Specifications Brochure, BRD8011/D.

# EMI7204MU, EMI7206MU, EMI7208MU

## PACKAGE DIMENSIONS

UDFN8, 1.7x1.35, 0.4P  
CASE 517BC-01  
ISSUE O

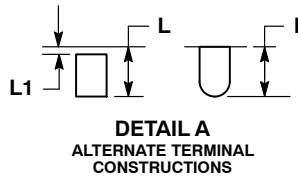
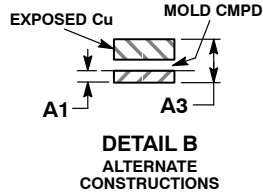
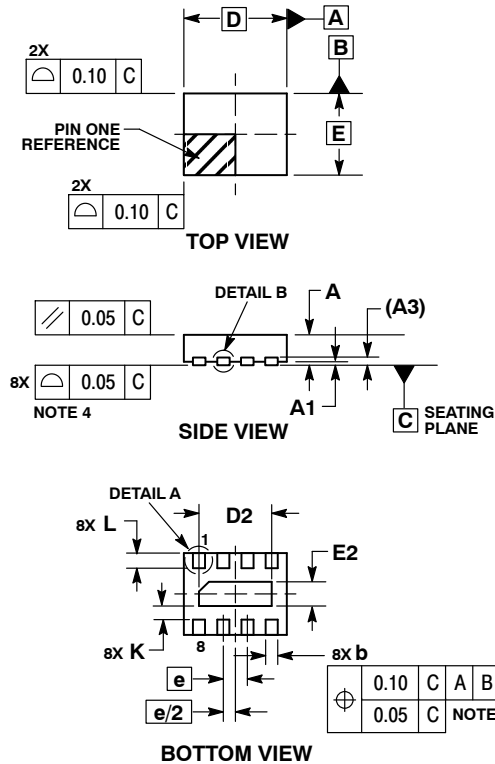

**NOTES:**

1. DIMENSIONING AND TOLERANCING PER ASME Y14.5M, 1994.
2. CONTROLLING DIMENSION: MILLIMETERS.
3. DIMENSION b APPLIES TO PLATED TERMINAL AND IS MEASURED BETWEEN 0.15 AND 0.25 mm FROM THE TERMINAL TIP.
4. COPLANARITY APPLIES TO THE EXPOSED PAD AS WELL AS THE TERMINALS.

DIM	MILLIMETERS	
	MIN	MAX
A	0.45	0.55
A1	0.00	0.05
A3	0.13	REF
b	0.15	0.25
D	1.70	BSC
D2	1.10	1.30
E	1.35	BSC
E2	0.30	0.50
e	0.40	BSC
K	0.15	---
L	0.20	0.30
L1	---	0.05

### RECOMMENDED SOLDERING FOOTPRINT\*

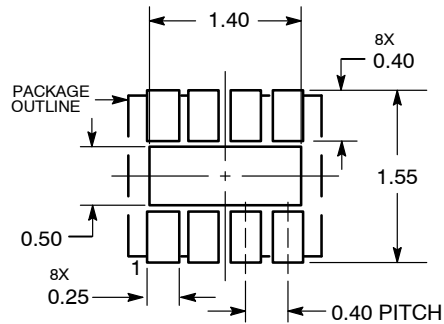

DIMENSIONS: MILLIMETERS

\*For additional information on our Pb-Free strategy and soldering details, please download the ON Semiconductor Soldering and Mounting Techniques Reference Manual, SOLDERRM/D.

# EMI7204MU, EMI7206MU, EMI7208MU

## PACKAGE DIMENSIONS

UDFN12, 2.5x1.35, 0.4P  
CASE 517BD-01  
ISSUE O

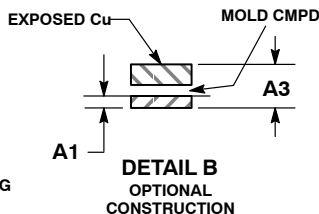
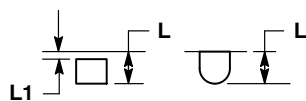
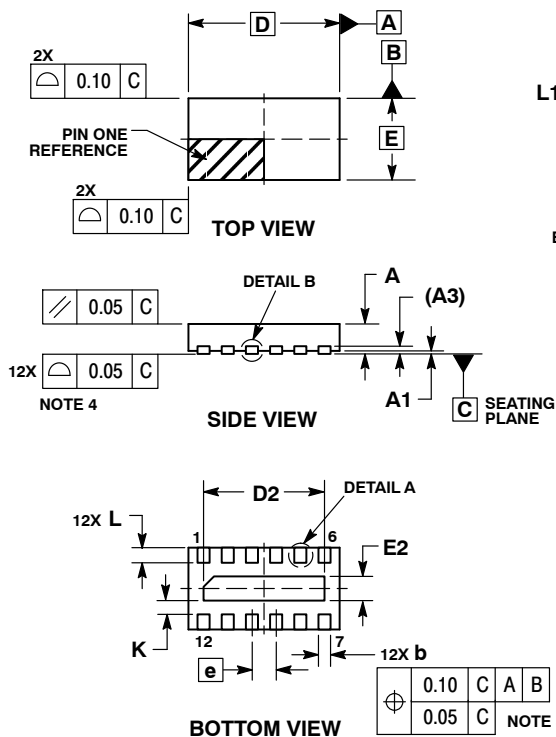

- NOTES:
1. DIMENSIONING AND TOLERANCING PER ASME Y14.5M, 1994.
  2. CONTROLLING DIMENSION: MILLIMETERS.
  3. DIMENSION b APPLIES TO PLATED TERMINAL AND IS MEASURED BETWEEN 0.15 AND 0.25 mm FROM THE TERMINAL TIP.
  4. COPLANARITY APPLIES TO THE EXPOSED PAD AS WELL AS THE TERMINALS.

DIM	MILLIMETERS	
	MIN	MAX
A	0.45	0.55
A1	0.00	0.05
A3	0.13	REF
b	0.15	0.25
D	2.50	BSC
D2	1.90	2.10
E	1.35	BSC
E2	0.30	0.50
e	0.40	BSC
K	0.15	---
L	0.20	0.30
L1	---	0.05

### RECOMMENDED SOLDERING FOOTPRINT\*

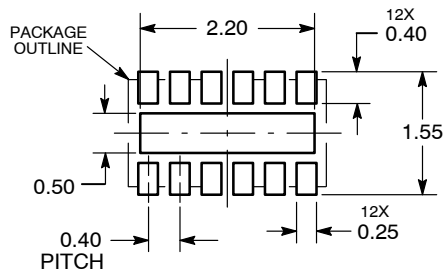

DIMENSIONS: MILLIMETERS

\*For additional information on our Pb-Free strategy and soldering details, please download the ON Semiconductor Soldering and Mounting Techniques Reference Manual, SOLDERRM/D.

# EMI7204MU, EMI7206MU, EMI7208MU

## PACKAGE DIMENSIONS

UDFN16, 3.3x1.35, 0.4P  
CASE 517BE-01  
ISSUE O

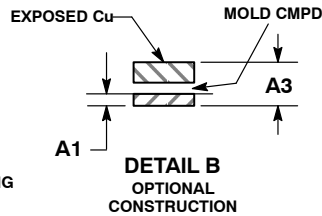
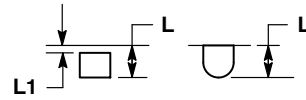
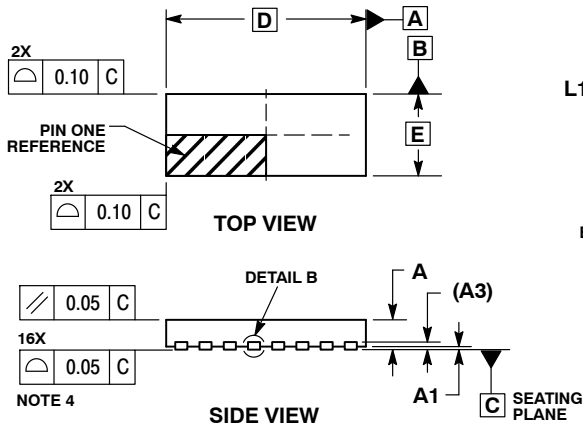

**NOTES:**

1. DIMENSIONING AND TOLERANCING PER ASME Y14.5M, 1994.
2. CONTROLLING DIMENSION: MILLIMETERS.
3. DIMENSION b APPLIES TO PLATED TERMINAL AND IS MEASURED BETWEEN 0.15 AND 0.25 mm FROM THE TERMINAL TIP.
4. COPLANARITY APPLIES TO THE EXPOSED PAD AS WELL AS THE TERMINALS.

MILLIMETERS		
DIM	MIN	MAX
A	0.45	0.55
A1	0.00	0.05
A3	0.13	REF
b	0.15	0.25
D	3.30	BSC
D2	2.70	2.90
E	1.35	BSC
E2	0.30	0.50
e	0.40	BSC
K	0.15	---
L	0.20	0.30
L1	---	0.05

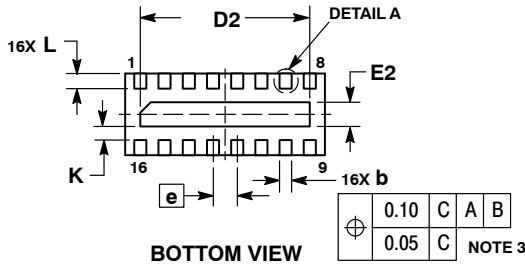

**RECOMMENDED SOLDERING FOOTPRINT\***

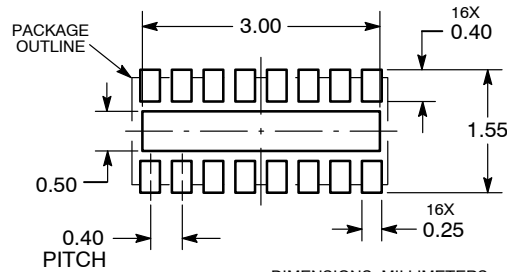

\*For additional information on our Pb-Free strategy and soldering details, please download the ON Semiconductor Soldering and Mounting Techniques Reference Manual, SOLDERRM/D.

Bluetooth is a registered trademark of Bluetooth SIG.

ON Semiconductor and are registered trademarks of Semiconductor Components Industries, LLC (SCILLC). SCILLC reserves the right to make changes without further notice to any products herein. SCILLC makes no warranty, representation or guarantee regarding the suitability of its products for any particular purpose, nor does SCILLC assume any liability arising out of the application or use of any product or circuit, and specifically disclaims any and all liability, including without limitation special, consequential or incidental damages. "Typical" parameters which may be provided in SCILLC data sheets and/or specifications can and do vary in different applications and actual performance may vary over time. All operating parameters, including "Typicals" must be validated for each customer application by customer's technical experts. SCILLC does not convey any license under its patent rights nor the rights of others. SCILLC products are not designed, intended, or authorized for use as components in systems intended for surgical implant into the body, or other applications intended to support or sustain life, or for any other application in which the failure of the SCILLC product could create a situation where personal injury or death may occur. Should Buyer purchase or use SCILLC products for any such unintended or unauthorized application, Buyer shall indemnify and hold SCILLC and its officers, employees, subsidiaries, affiliates, and distributors harmless against all claims, costs, damages, and expenses, and reasonable attorney fees arising out of, directly or indirectly, any claim of personal injury or death associated with such unintended or unauthorized use, even if such claim alleges that SCILLC was negligent regarding the design or manufacture of the part. SCILLC is an Equal Opportunity/Affirmative Action Employer. This literature is subject to all applicable copyright laws and is not for resale in any manner.

**PUBLICATION ORDERING INFORMATION**

**LITERATURE FULFILLMENT:**  
Literature Distribution Center for ON Semiconductor  
P.O. Box 5163, Denver, Colorado 80217 USA  
**Phone:** 303-675-2175 or 800-344-3860 Toll Free USA/Canada  
**Fax:** 303-675-2176 or 800-344-3867 Toll Free USA/Canada  
**Email:** orderlit@onsemi.com

**N. American Technical Support:** 800-282-9855 Toll Free USA/Canada  
**Europe, Middle East and Africa Technical Support:**  
Phone: 421 33 790 2910  
**Japan Customer Focus Center**  
Phone: 81-3-5773-3850

**ON Semiconductor Website:** [www.onsemi.com](http://www.onsemi.com)  
**Order Literature:** <http://www.onsemi.com/orderlit>  
For additional information, please contact your local Sales Representative

## Looking for pricing, stock, or lifecycle information?

Click below to explore more details on WIN SOURCE:

 [View EMI7208MUTAG on WIN SOURCE](#)

 [ON Semiconductor](#) Information

## Optimize Your Supply Chain with WIN SOURCE Solutions

-  Global Sourcing Solution
-  Obsolete Management
-  Cost Control Management
-  Shortage Management
-  Alternative Solution
-  Excess Inventory Management