

DESCRIPTION

These high power 50 W Zener diodes represented by the JEDEC registered 1N3305 thru 1N3350B and 1N4549 thru 1N4556B series provide voltage regulation in a selection over a 3.9 V to 200 V broad range of voltages. They may be operated up to 50 W with adequate mounting and heat sinking with their low thermal resistance. These Zeners are also available in JAN, JANTX, JANTXV military qualifications. Microsemi also offers numerous other Zener products to meet higher and lower power applications.

APPEARANCE

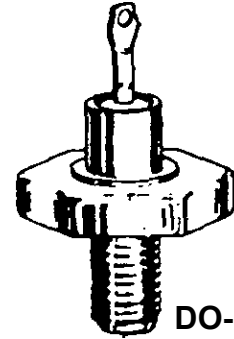

**DO-5
(DO-203AB)**

IMPORTANT: For the most current data, consult MICROSEMI's website: <http://www.microsemi.com>

FEATURES

- JEDEC registered 1N3305 thru 1N3350B and 1N4549 thru 1N4556B
- Internal solder bond construction
- Hermetically sealed (welded)
- Zener Voltage 3.9V to 200V.
- Also available in JAN, JANTX, and JANTXV qualifications per MIL-PRF-19500/358 by adding the JAN, JANTX, or JANTXV prefixes to part numbers for desired level of screening; (e.g. JANTX1N3305B, JANTXV1N3318B, etc.
- Standard polarity is anode to case
- Reverse polarity with cathode to case by designating R suffix in part number, e.g. 1N3305RB, etc.
- Consult factory for surface mount equivalents

APPLICATIONS / BENEFITS

- Regulates voltage over a broad operating current and temperature range
- Standard voltage tolerances are +/- 5% with B suffix, +/-10% with an A suffix, and +/-20% with no suffix
- Consult factory for +/-2% or +/-1% with a C or D suffix respectively
- Reverse polarity available
- Nonsensitive to ESD per MIL-STD-750 Method 1020
- Inherently radiation hard as described in Microsemi MicroNote 050

MAXIMUM RATINGS

- Junction & Storage Temperatures: -65°C to +175°C
- DC Power Dissipation: 50 watts at $T_C \leq 75^\circ\text{C}$
- Power Derating: 0.5 W/°C above 75°C
- Forward Voltage @ 10 A: 1.5 Volts
- THERMAL RESISTANCE: 2.0 °C/W maximum junction to hexagonal base (1.5 °C/W typical)
- Solder temperatures: 260 °C for 10 s (max)

MECHANICAL AND PACKAGING

- CASE: Industry Standard DO-5 (DO-203AB), 11/16 inch hexagonal stud with 1/4-28 threads welded hermetically sealed metal and glass
- FINISH: All external surfaces are corrosion resistant and terminal solderable.
- POLARITY: Standard Polarity units are connected anode to case. Reverse polarity (cathode to case) is indicated by Suffix R in part number
- WEIGHT: 15 grams
- MOUNTING HARDWARE: Consult factory for optional insulator, bushing, solder terminal, washers and nut
- See package dimensions on last page

*** ELECTRICAL CHARACTERISTICS @ 30°C Case Temperature**

JEDEC TYPE NO. (Note 1)	NOMINAL ZENER VOLTAGE V _Z @ I _{ZT} Volts (Note 2) †	ZENER TEST CURRENT (I _{ZT}) mA †	MAX. DYNAMIC IMPEDANCE (Note 3) †		MAX. DC ZENER CURRENT (I _{ZM}) mA	MAX. REVERSE CURRENT** I _R (max) @ V _R		TYPICAL TEMP. COEFF. α _{VZ} %/°C
			Z _{zT} @ I _{ZT} OHMS	Z _{zK} @ I _{ZK} = 5 mA OHMS		μA	VOLTS	
†1N4549B	3.9	3,200	0.16	400	11,900	150	0.5	-0.046
†1N4550B	4.3	2,900	0.16	500	10,650	150	0.5	-0.033
†1N4551B	4.7	2,650	0.12	600	9,700	100	1.0	-0.015
†1N4552B	5.1	2,450	0.12	650	8,900	20	1.0	+/-0.010
†1N4553B	5.6	2,250	0.12	900	8,100	20	1.0	+0.030
†1N4554B	6.2	2,000	0.14	1,000	7,300	20	2.0	+0.049
1N4555B	6.8	1,850	0.16	200	6,650	10	2.0	+0.053
1N4556B	7.5	1,650	0.24	100	6,050	10	3.0	+0.057
†1N3305B	6.8	1,850	0.20	70	6,600	300	4.5	0.040
†1N3306B	7.5	1,700	0.30	70	5,900	125	5.0	0.045
†1N3307B	8.2	1,500	0.40	70	5,200	50	5.4	0.048
†1N3308B	9.1	1,370	0.50	70	4,800	25	6.1	0.050
†1N3309B	10.0	1,200	0.60	80	4,300	25	6.7	0.055
†1N3310B	11.0	1,100	0.80	80	3,900	10	8.4	0.060
†1N3311B	12.0	1,000	1.00	80	3,800	10	9.1	0.065
†1N3312B	13.0	960	1.10	80	3,300	10	9.9	0.065
1N3313B	14.0	890	1.20	80	3,000	10	11.4	0.070
†1N3314B	15.0	830	1.40	80	2,800	10	11.4	0.070
†1N3315B	16.0	780	1.60	80	2,650	10	12.2	0.070
1N3316B	17.0	740	1.80	80	2,500	10	13.0	0.075
†1N3317B	18.0	700	2.00	80	2,300	10	13.7	0.075
1N3318B	19.0	660	2.20	80	2,200	10	13.7	0.075
†1N3319B	20.0	630	2.40	80	2,100	10	15.2	0.075
†1N3320B	22.0	570	2.50	80	1,900	10	16.7	0.080
†1N3321B	24.0	520	2.60	80	1,750	10	18.2	0.080
1N3322B	25.0	500	2.70	90	1,550	10	18.2	0.080
†1N3323B	27.0	460	2.80	90	1,500	10	20.6	0.085
†1N3324B	30.0	420	3.00	90	1,400	10	22.8	0.085
†1N3325B	33.0	380	3.20	90	1,300	10	25.1	0.085
†1N3326B	36.0	350	3.50	90	1,150	10	27.4	0.085
†1N3327B	39.0	320	4.00	90	1,050	10	29.7	0.090
†1N3328B	43.0	290	4.50	90	975	10	32.7	0.090
1N3329B	45.0	280	4.50	100	930	10	32.7	0.090
†1N3330B	47.0	270	5.00	100	880	10	35.8	0.090
1N3331B	50.0	250	5.00	100	830	10	38.8	0.090
†1N3332B	51.0	245	5.20	100	810	10	38.8	0.090
1N3333B	52.0	240	5.50	100	790	10	42.6	0.090
†1N3334B	56.0	220	6.00	110	740	10	42.6	0.090
†1N3335B	62.0	200	7.00	120	660	10	47.1	0.090
†1N3336B	68.0	180	8.00	140	600	10	51.7	0.090
†1N3337B	75.0	170	9.00	150	540	10	56.0	0.090
†1N3338B	82.0	150	11.00	160	490	10	62.2	0.090
†1N3339B	91.0	140	15.00	180	420	10	69.2	0.090
†1N3340B	100.0	120	20.00	200	400	10	76.0	0.090
1N3341B	105.0	120	25.00	210	380	10	83.0	0.095
†1N3342B	110.0	110	30.00	220	365	10	83.0	0.095
†1N3343B	120.0	100	40.00	240	335	10	91.2	0.095
†1N3344B	130.0	95	50.00	275	310	10	99.8	0.095
1N3345B	140.0	90	60.00	325	290	10	114.0	0.095
†1N3346B	150.0	85	75.00	400	270	10	114.0	0.095
†1N3347B	160.0	80	80.00	450	250	10	121.6	0.095
1N3348B	175.0	70	85.00	500	230	10	121.6	0.095
†1N3349B	180.0	68	90.00	525	220	10	136.8	0.095
†1N3350B	200.0	65	100.00	600	200	10	152.0	0.100

*JEDEC Registered Data. **Not JEDEC Data.

†Have JAN and JANTX and TXV Qualifications to MIL-S-19500/358.

See further notes on following page

- NOTES:**
1. When using JEDEC numbers an R suffix should be used to signify reversed polarity. The suffixes A and B indicate tolerances of 10% and 5% respectively. No suffix or just R denotes +/-20% tolerance. Example: 1N3319RB is a REVERSED polarity, 20 volt unit having a +/-5% tolerance on Zener Voltage.
 2. Zener Voltage (V_Z) is measured with junction in thermal equilibrium with 30°C stud temperature.
 3. The Zener impedance is derived from the 60 cycle ac voltage, which results when an ac current having an rms value equal to 10% of the dc zener current (I_{ZT} or I_{ZK}) is superimposed on I_{ZT} or I_{ZK} . Zener impedance is measured at 2 points to ensure a sharp knee on the breakdown curve and to eliminate unstable units. A curve showing the variation of zener impedance vs. zener current for three representative types is shown in Figure 2. Also see Microsemi MicroNote 202.

OUTLINE AND CIRCUIT



FIGURE 1
Power Derating Curve

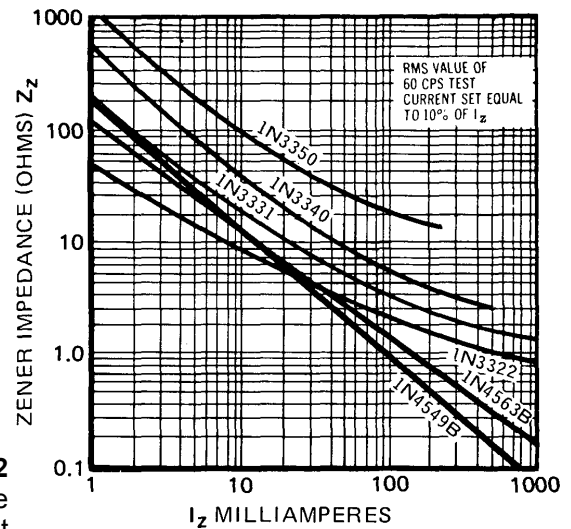
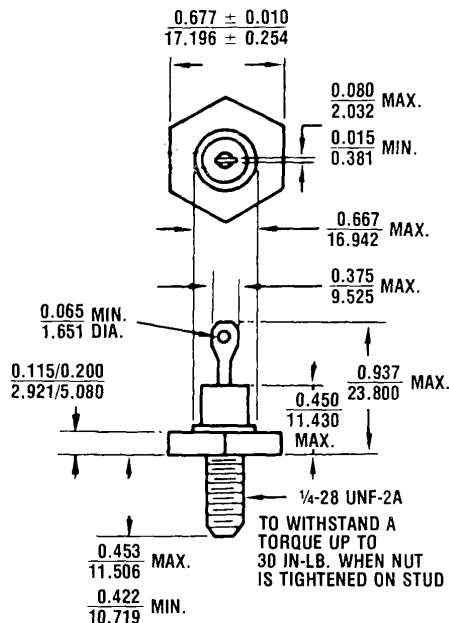

FIGURE 2
Typical Zener Impedance
vs. Zener Current

PACKAGE DIMENSIONS



All Dimensions in: INCH
mm

Looking for pricing, stock, or lifecycle information?

Click below to explore more details on WIN SOURCE:

-  [View 1N3344B on WIN SOURCE](#)
-  [Microsemi Corporation](#) Information

Optimize Your Supply Chain with WIN SOURCE Solutions

-  Global Sourcing Solution
-  Obsolete Management
-  Cost Control Management
-  Shortage Management
-  Alternative Solution
-  Excess Inventory Management